



KG800 | USER GUIDE



chocolate

KG800

Some of contents in this manual may differ from your phone depending on the software of the phone or your service provider.



LG Electronics Inc

| KG800 | User Guide

- English



Table of Contents

How to Use Touch Button	5	General functions	23	Call register	37
Introduction	7	Making and answering calls		Missed calls	
For Your Safety	8	Entering text	25	Received calls	
Guidelines for safe and efficient use	9	Changing the text input mode		Dialled calls	
KG800 features	14	Contacts	28	All calls	38
Parts of the phone		Selecting Functions and Options	29	Delete recent calls	
Display information	18	In-Call Menu	30	Call charges	
On-Screen Icons		During a call		Call duration	
		Multiparty or conference calls	31	Call costs	
Installation	20	Menu Tree	33	Settings	
Installing the SIM card and the handset battery		Profiles	35	GPRS information	39
Charging the battery	21	Activate		Call duration	
Disconnecting the charger	22	Personalise		Data volume	
		Rename	36	Tools	40
				Favourites	
				Alarm clock	
				Calculator	
				Unit converter	41
				World time	
				SIM-Menu	

Organiser	42	Messages	48	Multimedia	58
Contacts		New message		Camera	
Search contacts		Write text message		Video camera	59
Add new		Write multimedia message	49	Voice recorder	
Caller groups	43	Inbox	51	Record	
Speed dial	44	Drafts	52	View list	60
Own number		Outbox		MP3	
My business card		Listen to voice mail	55	Photo album	62
Settings		Info message		Video album	63
Calendar	46	Read		Settings	
Add new		Topics	54	Camera	
View daily schedules		Templates		Video camera	
Delete past		Text templates			
Delete all		Multimedia templates			
Go to date	47	Settings	55		
Set alarm tone		Text message			
Memo		Multimedia message			
		Voice mailbox number	57		
		Info message	58		
		Push message			

Table of Contents

Browser	64	Settings	76	Call waiting	83
Home	65	Date & time		Minute minder	
Bookmarks		Date		Auto redial	
Go to URL		Time		Security	
Settings		Display		PIN code request	
Profiles		Wallpaper		Handset lock	84
Cache	67	Menu colour		Call barring	
Cookie		Standby text		Fixed dial number	85
Clear cache		Backlight	77	Change codes	
Clear cookie		Brightness		Touchpad lock	
Security		Network name		Memory status	86
		Home screen shortcut		Reset settings	
My stuff	68	Dial font colour			
Games & apps		Power saving		Accessories	87
Games & apps		Language		Technical Data	88
Profiles		Connectivity			
Videos	72	Bluetooth			
Photos		Modem	80		
Music	73	Network			
Text		GPRS attach	81		
Images	74	Calling			
Sounds		Call divert			
Others	75	Answer mode	82		
		Send my number			

How to Use Touch Button

- ▶ This product's buttons on the slide are touch buttons.
- ▶ Be sure to read "Cautions for Touch Buttons" before using touch buttons.

Cautions for Touch Buttons

1. Make sure your hands are clean and dry.
 - Remove all moisture from the surface of your hands or the touch buttons in a humid environment.

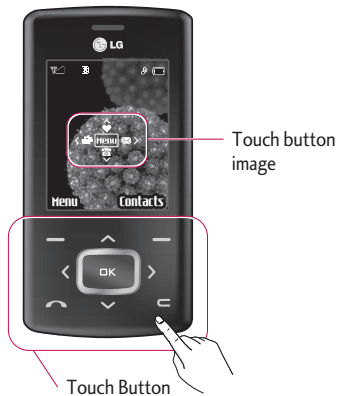

2. You do not need to press hard on the touch buttons to make it work normally. Keep product from severe impact, as sensors of the touch buttons may be damaged.
3. Use the **tip** of your finger to press exactly on the touch button you want, being careful not to touch the buttons for other functions.
4. When both the home screen and touch button lights are off, pressing a touch button will not turn on the home screen light. Press the End button and the home screen light will turn back on (touch buttons do not work when the touch button lights are off).
5. If the slide is closed and the **Touch Protection** function is on, during calls the **Touch button Lock** function is automatically enabled. (For details, see 'Touch Button Status When Using Mobile Phone'.)

How to Use Touch Button

6. Touch buttons may not work normally if a mobile phone case or plastic is covering the touch buttons. Also, touch buttons may not work normally if you are using it wearing a glove.
7. Keep metal and other conductive material away from the surface of touch buttons, as contact with them may result in error.

Touch Button Status When Using Mobile Phone



When the slide is closed, to prevent indiscreet action of the touch buttons whilst using the phone or during calls, the **Touch Protection** function is automatically enabled. (In this case, the touch buttons will not work even if they are pressed)

1. When slide is closed

- When the slide is closed, Touch Protection function is automatically enabled. (Opening the slide will automatically disable it.)

- To disable Touch Protection when slide is closed, press volume button twice.
- After disabling Touch Protection, if there is no button action for a certain duration (5 seconds), Touch Protection function is enabled again.

2. During calls

- During calls, regardless of slide status, Touch Protection function is automatically enabled.
- To disable Touch Protection, press the MP3 button or number button,  button, or  button.
- After disabling Touch button Lock, if there is no button action for a certain duration (5 seconds), the Touch Protection function is enable again.

Note

- ▶ For user convenience, touch button image with functions of each touch button is shown on the home screen when purchasing products.

Introduction

Congratulations on your purchase of the advanced and compact KG800 cellular phone, designed to operate with the latest digital mobile communication technology.

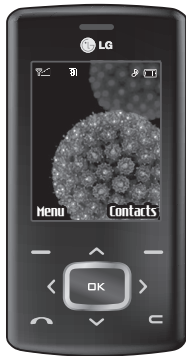

This user's guide contains important information on the use and operation of this phone. Please read all the information carefully for optimal performance and to prevent any damage to or misuse of the phone. Any changes or modifications not expressly approved in this user's guide could void your warranty for this equipment.

Use of phone cases with magnetic locks with slide type phones has caused problems such as loss of network signal and phones powering off.

For Your Safety

Please read these simple guidelines. Not following these guidelines may be dangerous or illegal. Further detailed information is given in this manual.

WARNING!

- *Mobile Phones must be switched off at all times in aircrafts.*
- *Do not hold the phone in your hand while driving.*
- *Do not use your phone near petrol stations, fuel depots, chemical plants or blasting operations.*
- *For your safety, use ONLY specified ORIGINAL batteries and chargers.*
- *Do not handle the phone with wet hands while it is being charged. It may cause an electric shock or seriously damage your phone.*
- *Keep the phone in a safe place out of small children's reach. It includes small parts which, if detached, may cause a choking hazard.*

CAUTION!

- *Switch off the phone in any area where required by special regulations. For example, do not use your phone in hospitals or it may affect sensitive medical equipment.*
- *Emergency calls may not be available under all mobile networks. Therefore, you should never depend solely on your mobile phone for emergency calls.*
- *Only use ORIGINAL accessories to avoid damage to your phone.*
- *All radio transmitters carry risks of interference with electronics in close proximity. Minor interference may affect TVs, radios, PCs, etc.*
- *Batteries should be disposed of in accordance with relevant legislation.*
- *Do not dismantle the phone or battery.*

Guidelines for safe and efficient use

Radio wave exposure and Specific Absorption Rate (SAR) information

This mobile phone model KG800 has been designed to comply with applicable safety requirements for exposure to radio waves.

This requirement is based on scientific guidelines that include safety margins designed to assure the safety of all persons, regardless of age and health.

- ▶ The radio wave exposure guidelines employ a unit of measurement known as the Specific Absorption Rate, or SAR. Tests for SAR are conducted using standardised methods with the phone transmitting at its highest certified power level in all used frequency bands.
- ▶ While there may be differences between the SAR levels of various LG phone models, they are all designed to meet the relevant guidelines for exposure to radio waves.

- ▶ The SAR limit recommended by the International Commission on Non-Ionizing Radiation Protection (ICNIRP) is 2W/kg averaged over ten (10) gram of tissue.
- ▶ The highest SAR value for this model phone tested by DASY4 for use at the ear is 0.084 W/kg (10g).
- ▶ SAR data information for residents in countries/ regions that have adopted the SAR limit recommended by the Institute of Electrical and Electronics Engineers (IEEE) is 1.6 W/kg averaged over one (1) gram of tissue.

Product care and maintenance

WARNING!

Only use batteries, chargers and accessories approved for use with this particular phone model. The use of any other types may invalidate any approval or warranty applying to the phone, and may be dangerous.

Guidelines for safe and efficient use

- ▶ Do not disassemble this unit. Take it to a qualified service technician when repair work is required.
- ▶ Keep away from electrical appliances such as TV's, radios and personal computers.
- ▶ The unit should be kept away from heat sources such as radiators or cookers.
- ▶ Do not drop.
- ▶ Do not subject this unit to mechanical vibration or shock.
- ▶ The coating of the phone may be damaged if covered with wrap or vinyl wrapper.
- ▶ Do not use harsh chemicals (such as alcohol, benzene, thinners, etc.) or detergents to clean your phone. There is a risk of causing fire.
- ▶ Do not subject this unit to excessive smoke or dust.
- ▶ Do not keep the phone next to credit cards or transport tickets; it can affect the information on the magnetic strips.
- ▶ Do not tap the screen with sharp objects as, it may damage the phone.
- ▶ Do not expose the phone to liquid or moisture.
- ▶ Use the accessories like an earphone cautiously.
- ▶ If you put your phone in a pocket or bag without covering the receptacle of the phone (power plug pin), metallic articles (such as a coin, paperclip or pen) may short-circuit the phone. Always cover the receptacle when not in use.
- ▶ Never place your phone in a microwave oven as it will cause the battery to explode.
- ▶ Only authorised personnel should service the phone and its accessories. Faulty installation or service may result in accidents and consequently invalidate the warranty.
- ▶ Do not use the phone if the antenna is damaged. If a damaged antenna contacts skin, it may cause a slight burn. Please contact an LG Authorised Service Centre to replace the damaged antenna.
- ▶ The label on the phone contains important information for customer support purposes. Do not remove it.

- ▶ Use accessories, such as earphones and headsets, with caution. Ensure that cables are tucked away safely and do not touch the antenna unnecessarily.

Efficient phone operation

To enjoy optimum performance with minimum power consumption please:

- ▶ Hold the phone as you speak to any other telephone. While speaking directly into the microphone, angle the antenna in a direction up and over your shoulder. If the antenna is extendable/retractable, it should be extended during a call.
- ▶ Do not hold the antenna when the phone is in use.
If you hold it, it can affect call quality, it also may cause the phone to operate as a higher power level than needed and shorten talk and standby times.
- ▶ If your mobile phone supports infrared, never direct the infrared ray at anyone's eyes.

Electronic devices

All mobile phones may get interference, which could affect performance.

- ▶ Do not use your mobile phone near medical equipment without requesting permission. Avoid placing the phone over pacemakers, (i.e. in your breast pocket).
- ▶ Some hearing aids might be disturbed by mobile phones.
- ▶ Minor interference may affect TVs, radios, PCs, etc.
- ▶ Do not bend, scratch, or expose to static electricity.

Road safety

Check the laws and regulations on the use of mobile phones in the areas when you drive.

- ▶ Do not use a hand-held phone while driving.
- ▶ Give full attention to driving.
- ▶ Use a hands-free kit, if available.

Guidelines for safe and efficient use

- ▶ Pull off the road and park before making or answering a call if driving conditions so require.
- ▶ RF energy may affect some electronic systems in your motor vehicle such as a car stereo or safety equipment.
- ▶ When driving in a car, do not leave your phone or set up the hands-free kit near to the air bag. If wireless equipment is improperly installed and the air bag is activated, you may be seriously injured.
- ▶ Do not transport or store flammable gas, liquid, or explosives in the compartment of your vehicle, which contains your mobile phone and accessories.

Blasting area

Do not use the phone where blasting is in progress. Observe restrictions, and follow any regulations or rules.

Potentially explosive atmospheres

- ▶ Do not use the phone at a refueling point. Don't use near fuel or chemicals.

In aircraft

Wireless devices can cause interference in aircraft.

- ▶ Turn off your mobile phone before boarding any aircraft.
- ▶ Do not use it on the ground without crew permission.

Battery information and care

- ▶ You do not need to completely discharge the battery before recharging. Unlike other battery systems, there is no memory effect that could compromise the battery's performance.

- ▶ Use only LG batteries and chargers. LG chargers are designed to maximize the battery life.
- ▶ Do not disassemble or short-circuit the battery pack.
- ▶ Keep the metal contacts of the battery pack clean.
- ▶ Replace the battery when it no longer provides acceptable performance. The battery pack may be recharged hundreds of times until it needs replacement.
- ▶ Recharge the battery if it has not been used for a long time to maximize usability.
- ▶ Do not expose the battery charger to direct sunlight or use it in high humidity areas, such as the bathroom.
- ▶ Do not leave the battery in very hot or cold places, this may deteriorate the battery's performance.

Network service

- ▶ Some services and functions described in this user's guide are dependent on network or subscription. Therefore, all menus may not be available in your phone. Please consult your network operator for more information about your subscription.

Avoid damage to your hearing

- ▶ Damage to your hearing can occur if you are exposed to loud sound for long periods of time. We therefore recommend that you do not turn the handset on or off close to your ear. We also recommend that music and call volumes are set to a reasonable level.
- ▶ If you are listening to music whilst out and about, please ensure that the volume is at a reasonable level so that you are aware of your surroundings. This is particularly imperative when attempting to cross the street.





KG800 features

Parts of the phone

Open view

Navigation keys

▶ In standby mode:

-  Briefly: List of Favourites
-  Briefly: List of Contacts
-  Briefly: List of Profiles
(Hold down: Activate/
Deactivate Vibrate mode)
-  Briefly: List of Messages





▶ In menu: scroll up & down

Earpiece

Main LCD

- ▶ **Top:** Icons showing signal strength, battery level and various other functions.
- ▶ **Bottom:** Soft key indications

Alpha numeric keys

- ▶ **In standby mode:** Input numbers to dial. Hold down
 -  - International calls
 -  - Dial Voice mail centre.
 -  to  - Speed dials
- ▶ **In editing mode:** Enter numbers & characters





Left soft key/ Right soft key

These keys perform the function indicated in the bottom of the display.

Confirm key

Selects menu options and confirms actions.

Clear key

Deletes a character with each press.
Hold the key down to clear all input.
Use this key to go back to a previous screen.

Send key

- ▶ Dial a phone number and answer a call.
- ▶ **In standby mode:** shows a history of calls made, received, and missed.

KG800 features

Left side view



Side keys

- ▶ **In standby mode (opened):**
Volume of key tone
- ▶ **In standby mode (closed):**
The main LCD light on.
- ▶ **In menu:** scroll up & down
- ▶ **During a call:** volume of the earpiece

Note

- ▶ To protect the sense of hearing while Slide open, maximum volume level is 3.

Right side view



End key

- ▶ **Switch on** (hold down)
- ▶ **Switch off** (opened) (hold down)
- ▶ **End or reject a call.**

MP3/Camera/Video camera key (opened)

- ▶ Activates the MP3 player (long press) and Multimedia menu (short press) directly.

Rear view

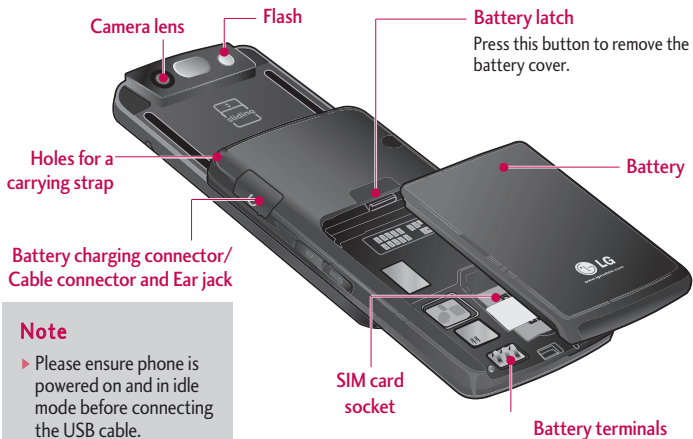

Note

- ▶ Please ensure phone is powered on and in idle mode before connecting the USB cable.

KG800 features



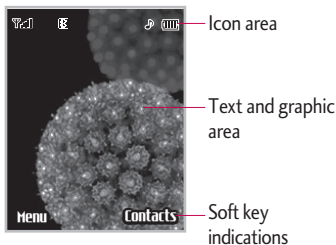





Display Information



Area	Description
First line	Displays various icons.
Middle lines	Display messages, instructions and any information that you enter, such as number to be dialed.
Last line	Shows the functions currently assigned to the two soft keys.









The screen displays several icons. These are described below.

On-Screen Icons

Icon/Indicator	Description
	Tells you the strength of the network signal.
	Call is connected.
	You can use GPRS service.
	Shows that you are using a roaming service.
	The alarm has been set and is on.
	Tells you the status of the battery.
	You have received a text message.
	You have received a voice message.

Note

- ▶ The quality of the conversation may change depending on network coverage. When the signal strength is below 2 bars, you may experience muting, call drop and poor audio. Please refer to this signal as an indicator for your calls. When there are no bars, that means that there is no network coverage: in this case, you won't be able to access the network for any service (call, messages and so on).

Icon/Indicator	Description
	Vibrate only menu in profile.
	General menu in profile.
	Loud menu in profile.
	Silent menu in profile.
	Headset menu in profile.
	You can divert a call.
	Indicates that the phone is accessing the WAP.
	Indicates that you are using GPRS.
	You have activated Bluetooth menu.

Installation

Installing the SIM card and the handset battery

Make sure the power is off before you remove the battery.

1. Remove the battery.

Press and hold down the battery release button and slide the battery down.

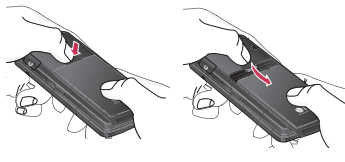

2. Install the SIM card.

Insert and slide the SIM card into the SIM card holder. Make sure that the SIM card is inserted properly and that the gold contact area on the card is facing downwards. To remove the SIM card, press down lightly and pull it in the reverse direction.



To insert the SIM card To remove the SIM card

Note

- ▶ The metal contact of the SIM card can be easily damaged by scratches. Pay special attention to the SIM card while handling. Follow the instructions supplied with the SIM card.

3. Install the battery.

Slide the battery upwards until it snaps back into place.



Charging the Battery

Before connecting the travel adapter to the phone you must first install the battery.



1. Ensure the battery is fully charged before using the phone for the first time.
2. With the arrow facing you as shown in the diagram push the plug on the battery adapter into the socket on the side of the phone until it clicks into place.
3. Connect the other end of the travel adapter to the mains socket. Use only the charger included in the box.
4. The moving bars of battery icon will stop after charging is complete.

Installation

CAUTION!

- Do not force the connector as this may damage the phone and/or the travel adapter.
- If you use the battery pack charger out of your own country, use an attachment plug adaptor for the proper configuration.
- Do not remove your battery or the SIM card while charging.

WARNING!

- Unplug the power cord and charger during lightning storms to avoid electric shock or fire.
- Make sure that no sharp-edged items such as animal teeth or nails, come into contact with the battery.
There is a risk of this causing a fire.
- Do not place or answer calls while charging the phone as it may short-circuit the phone and/or cause electric shock or fire.

Disconnecting the charger



Disconnect the travel adapter from the phone as shown in the diagram below.





General Functions

Making and answering calls



Making a call

1. Make sure your phone is switched on.
2. Enter a phone number, including the area code.
 - ▶ Press and hold the clear key  to erase the entire number.
3. Press the send key  to call the number.
4. To end the call, press the end key .

Making a call from the call history list

1. In standby mode, first open the slider then press the send key , and the latest incoming, outgoing and missed phone numbers will be displayed.
2. Select the desired number by using the up/down navigation keys.
3. Press  to call the number.

Making an international call

1. Press and hold the  key for the international prefix. The '+' character automatically selects the international access code.
2. Enter the country code, area code, and the phone number.
3. Press  to call the number.

Ending a Call

When you have finished your call, press the end  key.

Making a call from the phonebook

You can save the names and phone numbers dialled regularly in Contacts. You can save them to the SIM card and/or phone memory. You can dial a number by simply looking up the desired name in the phonebook and pressing the  key.

General Functions

Adjusting the volume

If you want to adjust the earpiece volume during a call, use the side keys . Press the up side key to increase and down side key to decrease the volume.

Note



- ▶ In standby mode with the phone open, pressing the side keys adjusts the key tone volume.

Answering a call

When you receive a call, the phone rings and the flashing phone icon appears on the screen. If the caller can be identified, the caller's phone number (or name/photo if saved in the phonebook) is displayed.

1. To answer an incoming call, open the phone. (When Slide open has been set as the answer mode. (Menu 9.6.2).)

Note

- ▶ If Press any key has been set as the answer mode any key press will answer a call except for the  or the right soft key.
- ▶ You can answer a call while using the address book or other menu features.
 2. To end the call, close the phone (Slider) or press the  key.

Signal strength

You can check the strength of your signal by the signal indicator () on the LCD screen of your phone. Signal strength can vary, particularly inside buildings. Moving near to a window may improve reception.

Entering text

You can enter alphanumeric characters by using the phone's keypad. For example, storing names in the phonebook, writing a message, creating a personal greeting. The following text input methods are available in the phone.

T9 mode

This mode lets you enter words with only one keystroke per letter. Each key on the keypad has more than one letter. The T9 mode automatically compares your keystrokes with an internal dictionary to determine the correct word, thus requiring far fewer keystrokes than the traditional ABC mode. This is sometimes known as predictive text.

ABC mode

This mode lets you enter letters by pressing the key labelled with the required letter once, twice, three or four times until the letter is displayed.

123 mode (Number mode)

Type numbers using one keystroke per number. To change to 123 mode in a text entry field, press the  key until 123 mode is displayed.

Changing the text input mode

1. When you are in a field that allows characters to be entered, you will notice the text input mode indicator in the top right corner of the LCD screen.

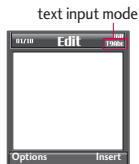

General Functions

2. Change the text input mode by pressing # 45. You can check the current text input mode in the top right corner of the LCD screen.

Using the T9 mode

The T9 predictive text input mode lets you enter words easily with a minimum number of key presses. As you press each key, the phone begins to display the characters that it thinks you are typing based on the built-in dictionary.

You can also add new words in the dictionary. As new words are added, the word changes to reflect the most likely candidate from the dictionary. You can turn the T9 mode on or off, and change the T9 language by holding down the () key.

1. When you are in the T9 predictive text input mode, start entering a word by pressing keys 2 ABC to 9 WXYZ. Press one key per letter.
 - ▶ The word changes as letters are typed. Ignore what's on the screen until the word is typed completely.

- ▶ If the word is still incorrect after typing completely, press the down navigation key once or more to cycle through the other word options.

Example: Press 4 PH 6 MMS 6 MMS 3 ME to type **Good**.

Press 4 PH 6 MMS 6 MMS 3 ME
[down navigation key] to type **Home**.



- ▶ If the desired word is missing from the word choice list, add it using the ABC mode.
 - ▶ You can select the language of the T9 mode. Press the left soft key [Option], then select T9 languages. Select the desired language of T9 mode. You can also turn off the T9 mode by selecting T9 off. The default setting on the phone is T9 enabled mode.
2. Enter the whole word before editing or deleting any keystrokes.
 3. Complete each word with a space by pressing the 0 SPACE key. To delete letters, press . Press and hold down to erase entire words.

Note

- ▶ To exit from the text input mode without saving your input, press . The phone goes back to standby mode.











Using the ABC mode

Use the  to  keys to enter your text.

1. Press the key labelled with the required letter:
 - ▶ Once for the first letter.
 - ▶ Twice for the second letter.
 - ▶ And so on.
2. To insert a space, press the  key once. To delete letters, press the  key. Press and hold down the  key to clear the whole display.

Note

- ▶ Refer to the table below for more information on the characters available using the alphanumeric keys.

Key	Characters in the order display	
	Upper Case	Lower Case
	.,/?!-:"'1	.,/?!-:"'1
	A B C 2	a b c 2
	D E F 3	d e f 3
	G H I 4	g h i 4
	J K L 5	j k l 5
	M N O 6	m n o 6
	P Q R S 7	p q r s 7
	T U V 8	t u v 8
	W X Y Z 9	w x y z 9
	Space 0	Space 0

General Functions

Using the 123 (Number) mode

The 123 mode enables you to enter numbers in a text message (a telephone number, for example).

Press the keys corresponding to the required digits before manually switching back to the appropriate text entry mode. You can quickly switch from letters to numbers by pressing and holding down the () key.

Using the Symbol Mode

The Symbol Mode enables you to enter various symbols or special characters.

To enter a symbol, press the  key. Use the navigation keys to scroll through the symbols and press the corresponding key and then press the [OK] key.



Contacts

You can store phone numbers and their corresponding names in the memory of your SIM card.

In addition, you can store up to 1000 numbers and names in the phone memory.

The SIM card and phone are both used in the same way in the Contacts menu.

Selecting Functions and Options

Your phone offers a set of functions that allow you to customise the phone. These functions are arranged in the menus and sub-menus, accessed via the two soft keys marked  and . Each menu and sub-menu lets you view and alter the settings of a particular function.

The role of the soft keys vary according to the current context or the label on the bottom line of the screen just above each key indicates its current role.



Press the left soft key to access the available menu.

Press the right soft key to access the available Contacts.

In-call menu

Your phone provides a number of control functions that you can use during a call. To access these functions during a call, initially press the MP3 key to unlock the touch screen and then press the left soft key [Options].

During a call

The menu displayed on the handset screen during a call is different to the default main menu displayed when in standby mode, and the options are described below.

Making a second call

You can get a number you wish to dial from the phonebook to make a second call. Press the right soft key selecting **Contacts**. To save the dialled number into the phonebook during a call, press the right soft key then select **Add new**.

Switching between two calls

To switch between two calls, press the left soft key then select **Swap**.

Answering an incoming call

To answer an incoming call when the handset is ringing, slide open the phone then press the  key. The handset is also able to warn you of an incoming call while you are already on a call. A tone sounds in the earpiece, and the display will show that a second call is waiting.

This feature, known as **Call waiting**, is only available if your network supports it. For details of how to activate and deactivate it see **Call waiting** (Menu 9.6.4)

If **Call waiting** is activated, you can put the first call on hold and answer the second, by pressing or by selecting the left soft key, then Hold & Answer. You can end the current call and answer the waiting call by selecting the Right soft key and then **End & Answer**.

Rejecting an incoming call

You can reject an incoming call without answering by simply pressing the  key.

During a call, you can reject an incoming call by pressing the Right soft key [Menu] key and selecting the **Conference/Reject** or by pressing the .

Muting the microphone

You can mute the microphone during a call by pressing the [Options] key then selecting **Mute on**. The handset can be unmuted by selecting **Mute off**. When the handset is muted, the caller cannot hear you, but you can still hear them.

Switching DTMF tones on during a call

To turn DTMF tones on during a call, press the left soft key, and then select DTMF on. DTMF tones can be turned off the same way. DTMF tones allow your phone to make use of an automated switchboard.

Multiparty or conference calls

The multiparty or conference service provides you with the ability to have a simultaneous conversation with more than one caller, if your network operator supports this feature. A multiparty call can only be set up when you have one active call and one call

on hold, both calls having been answered. Once a multiparty call is set up, calls can be added, disconnected or separated (that is, removed from the multiparty call but still connected to you) by the person who set up the multiparty call. These options are all available from the In-Call menu. The maximum callers in a multiparty call are five. Once started, you are in control of the multiparty call, and only you can add callers to the multiparty call.

Making a second call

You can make a second call while currently on a call. Enter the second number and press the  key. When the second call is connected, the first call is automatically placed on hold. You can swap between calls by pressing the left soft key then selecting **Swap**.

Setting up a conference call

Place one call on hold and while the active call is on, press the left soft key and then select the **Conference/Join all**.

In-call menu

Putting a conference call on hold

Press the left soft key, then select the **Conference/Hold all**.

Activate the conference call on hold

Press the left soft key, then select the **Conference/Join all**.

Adding calls to the conference call

To add a call to an existing conference call, press the left soft key, then select the **Conference/Join all**.

Displaying callers in a conference call

To scroll through the numbers of the callers who make up a conference call on the handset screen, use the up/down navigation keys.

Taking a private call during a conference call

To have a private call with one caller from a conference call, display the number of the caller you wish to talk to on the screen, then press the left soft key. Select the **Conference/Private** to put all the other callers on hold.

Ending a conference call

The currently displayed caller from a conference call can be disconnected by pressing the **End** key. To end a conference call, press the left soft key, then select the **Conference/End multiparty**.

After pressing the left soft key, selecting all will end all the active and onhold calls.

Menu Tree

The following illustration shows the available menu structure and indicates the:

- ▶ Number assigned to each menu option.

1. Profiles	3. Tools	5. Messages
1.X.1 Activate	3.1 Favourites	5.1 New message
1.X.2 Personalise	3.2 Alarm clock	5.2 Inbox
1.X.3 Rename	3.3 Calculator	5.3 Drafts
	3.4 Unit converter	5.4 Outbox
	3.5 World time	5.5 Listen to voice mail
	3.6 SIM-Menu	5.6 Info message
2. Call register	4. Organiser	5.7 Templates
2.1 Missed calls	4.1 Contacts	5.8 Settings
2.2 Received calls	4.2 Calendar	
2.3 Dialed calls	4.3 Memo	
2.4 All calls		
2.5 Delete recent calls		
2.6 Call charges		
2.7 GPRS information		

Menu Tree

6. Multimedia

- 6.1 Camera
- 6.2 Video camera
- 6.3 Voice recorder
- 6.4 MP3
- 6.5 Photo album
- 6.6 Video album
- 6.7 Settings

7. Browser

- 7.1 Home
- 7.2 Bookmarks
- 7.3 Go to URL
- 7.4 Settings

8. My stuff

- 8.1 Games & apps
- 8.2 Videos
- 8.3 Photos
- 8.4 Music
- 8.5 Text
- 8.6 Images
- 8.7 Sounds
- 8.8 Others

9. Settings

- 9.1 Date & time
- 9.2 Display
- 9.3 Power saving
- 9.4 Language
- 9.5 Connectivity
- 9.6 Calling
- 9.7 Security
- 9.8 Memory status
- 9.9 Reset settings

In Profiles, you can adjust and customise the phone tones for different events, environments, or caller groups.

There are five preset profiles: **Vibrate only**, **Silent**, **General**, **Loud** and **Headset**. Each profile can be personalised. Press the left soft key [Menu] and select Profiles using up/down navigation keys.

Activate (Menu 1.X.1)

1. A list of profiles is displayed.
2. In the Profiles list, scroll to the profile you want to activate and press the left soft key  OK key.
3. Then, select Activate.

Personalise (Menu 1.X.2)

Scroll to the desired profile in the Profile list. After pressing the left soft key  or the OK key, select **Personalise**. The profile setting option opens. Set the option as required.

- ▶ **Call alert type:** Set the alert type for incoming calls.

- ▶ **Ring tone:** Select the desired ring tone from the list.
- ▶ **Ring volume:** Set the volume of the ringing tone.
- ▶ **Message alert type:** Set the alert type for messages.
- ▶ **Message tone:** Select the alert tone for messages.
- ▶ **Keypad tone:** Select the desired keypad tone.
- ▶ **Keypad volume:** Set the volume of keypad tone.
- ▶ **Slide tone:** Allows you to set the slide tone.
- ▶ **Effect sound volume:** Set the volume of effect sound.
- ▶ **Power on/off volume:** Set the volume of the ringing tone when switching the phone on/off.



Rename (Menu 1.X.3)

You can rename a profile and give it any name you choose to.

Profiles

Note

► **Vibrate only, Silent and Headset** profiles cannot be renamed.

1. To change the name of a profile, scroll to the profile in the profile list and after pressing the left soft key  or the OK key, select **Rename**.
2. Key in the desired name and press the OK key or the left soft key  [OK].

Call register

You can check the record of missed, received, and dialled calls only if the network supports the Calling Line Identification (CLI) within the service area.

The number and name (if available) are displayed together with the date and time at which the call was made. You can also view call times.

Missed calls

Menu 2.1

This option lets you view the last 10 unanswered calls. You can also:

- ▶ View the number if available and call it, or save it in the Address Book
- ▶ Enter a new name for the number and save both in the Address Book
- ▶ Send a message to this number
- ▶ Delete the call from the list

Received calls

Menu 2.2

This option lets you view the last 10 incoming calls. You can also:

- ▶ View the number if available and call it or save it in the Address Book
- ▶ Enter new name for the number and save both in the Address Book
- ▶ Send a message to this number
- ▶ Delete the call from the list

Dialled calls

Menu 2.3

This option lets you view the last 20 outgoing calls (called or attempted).

You can also:

- ▶ View the number if available and call it or save it in the Address Book
- ▶ Enter new name for the number and save both in the Address Book
- ▶ Send a message to this number
- ▶ Delete the call from the list

Call register

All calls

Menu 2.4

You can view all lists of outgoing or incoming calls.

Delete recent calls

Menu 2.5

Allows you to delete Missed calls, Received calls, Dialed Calls and All Calls at one time.

Call charges

Menu 2.6

Call duration (Menu 2.6.1)

Allows you to view the duration of your incoming and outgoing calls. You can also reset the call times.

The following timers are available:

- ▶ **Last call:** Duration of the last call.
- ▶ **All calls:** Total duration of all calls made and incoming calls since the timer was last reset.

- ▶ **Received calls:** Duration of the incoming calls.
- ▶ **Dialed calls:** Duration of the outgoing calls.
- ▶ **Reset all:** Allows you to reset the timers of all calls by pressing the left soft key  [Yes].

Call costs (Menu 2.6.2)

Allows you to check the cost of your last call, all calls, remaining and reset the cost. To reset the cost, you need to know your PIN2 code.

Settings (Menu 2.6.3) (SIM Dependent)

- ▶ **Set tariff:** You can set the currency type and the unit price. Contact your service providers to obtain charging unit prices. To select the currency or unit in this menu, you need the PIN2 code.

- ▶ **Set credit:** This network service allows you to limit the cost of your calls by selected charging units. If you select **Read**, the number of remaining unit is shown. If you select **Change**, you can change your change limit.
- ▶ **Auto display:** This network service allows you to automatically see the cost of your last calls. If set to **On**, you can see the last cost when the call is released.

GPRS information Menu 2.7

You can check the amount of data transferred over the network through the GPRS information option. In addition, you can also view how much time you are online.

Call duration (Menu 2.7.1)

You can check the duration of **Last call** and **All calls**. You can also reset the call timers.

Data volume (Menu 2.7.2)

You can check The **Sent**, **Received** or **All** data volumes and **Reset all**.

Tools

Favourites

Menu 3.1

This option allows you to add your own favourites to the list already provided. Once you create your own menu, you can access the desired function quickly in the idle screen by pressing the up navigation key.

Note

- ▶ The menu of SMS, MMS, Games & apps, Connectivity, Alarm clock, MP3 and Camera is already provided in your own favourites.

Alarm clock

Menu 3.2

You can set up to 5 alarm clocks to go off at a specified time.

1. Select **On** and enter the alarm time you want.
2. Select the repeat period: **Once, Mon.-Fri, Mon.-Sat, Everyday.**
3. Select the alarm tone you want and press  [OK].





4. Edit the alarm name and press  [OK].

Calculator

Menu 3.3

This contains the standard functions such as +, -, x, ÷ : **Addition, Subtraction, Multiplication, and Division.**

Furthermore, you can use the various function of calculator such as +/-, **sin, cos, tan, log, IN, exp, sqrt.**





1. Input the numbers by pressing numeric keys.
2. Use a navigation key to select a sign for calculation.
3. Then input the numbers.
4. Press  key to view the result.
5. To input the decimal number, press  key. If you press  key, you can enter ().
6. To end **Calculator**, press the right soft key  [Back].

Unit converter

Menu 3.4

This converts any measurement into a unit you want. There are 9 types that can be converted into units:

Currency, Area, Length, Weight, Temperature, Volume, Velocity, Shoes and Clothes.

1. You can select one of nine unit types by pressing  [OK] key.
2. Select the unit you want to convert by pressing  and . It's impossible to input “-” symbol in unit converter.
3. Select the standard value by using , .

World time

Menu 3.5

You can check the current time of Greenwich Mean Time (GMT) and major cities around the world, using the left/right navigation keys.

The screen shows the city name, current date and time.

To select the time zone in which you are located, proceed as follows:

1. Select the city corresponding to your time zone by pressing the left/right navigation keys one or more times. The local date and time are displayed.
2. If you want to change the time display in standby mode to the selected time, press the left soft key and select **Set**.

SIM-Menu

MENU 3.6

This menu depends on SIM and the network services.

Note

- ▶ In case the SIM card support SAT (i.e. SIM Application Toolkit) services, this menu will be the operator specific service name stored on the SIM card.
- ▶ In case the SIM card does not support SAT services, this menu will be Profiles.

Organiser

Contacts

Menu 4.1

Search contacts (Menu 4.1.1)

1. Select **Search** by pressing the right soft key  [Contacts] or [OK].
2. Enter the name that you want to search.

Note

- ▶ Instant searching is available by inputting the initial letter of the name or number you want to search.

3. If you want to edit, delete or copy an entry, select the left soft key  [Options]. The following menu will be displayed.

- ▶ **Edit:** You can edit the name, number, group, character and picture by using the navigation key.
- ▶ **Write messages:** After you have found the number you want, you can send a text/multimedia message to the selected number.

- ▶ **Send via Bluetooth:** You can send the data of phone book to devices which is compatible with Bluetooth through Bluetooth.
- ▶ **Copy to handset:** You can copy an entry from SIM to phone or from phone to SIM.
- ▶ **Assign speed dial:** You can assign the entry as a speed dial.
- ▶ **View caller groups:** For further details see (Menu 4.1.3).
- ▶ **Delete:** You can delete an entry.

Note

- ▶ To use the Photo Caller ID feature, contacts must exist within the Phone Book and photos must be taken in 72x72 resolution. For more information about associating a photo to a contact please refer to the Camera section.







Add new (Menu 4.1.2)

You can add a phonebook entry by using this function. Phone memory capacity is 1000

entries. SIM card memory capacity depends on the mobile service provider. You can also save 40 characters of name in The Phone memory, and save characters in the SIM card. The number of characters is a SIM dependent feature.

Note

- ▶ Maximum stored name and number length depends on SIM-card type.



1. Select **Add new** by pressing the left soft key  [OK] or [OK].
2. Select the memory you want to save: **SIM** or **Phone**. If you set to Phone, you need to select which number you want as a main number.
 - a. Press  [OK] to input a name.
 - b. Press  [Save], then you can input a number.
 - c. You can set a group for the entry by pressing , .
 - d. You can set a picture for the entry by pressing , .

Caller groups (Menu 4.1.3)



You can add up to 20 members per group, with up to a maximum of 7 groups in total.

- ▶ **Member list:** Shows the group members you have selected.
- ▶ **Group ring tone:** Allows you to specify ring tone for the group members' call.
- ▶ **Group icon:** Allows you to select the icon dependent on Group.
- ▶ **Add member:** You can add group members. Each group should not exceed 20 members.
- ▶ **Remove member:** You can remove the member from the Group member list. But the name and the number will remain in the phonebook.
- ▶ **Rename:** You can change a group name.
- ▶ **Remove all:** Allows you to delete all the members in the group.

Speed dial (Menu 4.1.4)

Assign contacts to any of the keys  to .

You can then call that contact by pressing the corresponding number key.

1. Open the phonebook first by pressing the right soft key  [Contacts] in standby mode.
2. Scroll to **Speed dial**, then press the left soft key  [OK].
3. If you want to add speed dial, select **(empty)**. Then, you can search the name in phonebook.
4. After assigning the number as speed dial, you can change and delete the entry. You can also make a call or send a message to this number.



Own number (Menu 4.1.5) (Sim dependent)

You can save and check your own number in SIM card.

My business card (Menu 4.1.6)

This option allows you to create your own business card featuring Name and a mobile phone number. To create a new business card, press the left soft key  [Add] and enter the information into the fields.

Settings (Menu 4.1.7)

1. Press the right soft  [Contacts] in standby mode.
2. Scroll to **Settings**, then press the left soft key  [OK].

▶ Default memory

Scroll to highlight **Default memory**, and then press the left soft key  [OK].

- If you select **Always ask**, when adding an entry, the phone will ask where to store it.

- If you select **SIM** or **Handset**, the phone will store an entry to the SIM or phone.



▶ View options

Scroll to highlight **View options**, and then press the left soft key  [OK].

- **Name only:** Set the phonebook list by displaying the name only.
- **Name & number:** Set the phonebook list by displaying the name and number.
- **With pictures:** Set the phonebook list with the information and picture of contact.

▶ **Copy/Move all**





You can copy/move entries from SIM card memory to Phone memory and vice versa.

1. Open the Phonebook first by pressing the right soft key  [Contacts] in standby mode.
2. Scroll to **Copy/Move all**, and then press the left soft key  [OK] to enter this menu.
 - **SIM to Handset:** You can copy/move the entries from SIM Card to Phone memory.
 - **Handset to SIM:** You can copy/move the entries from Phone memory to SIM Card.

- ▶ **Memory in use:** This feature allows you to see how many entries are in use, or free in your phonebook.

▶ **Clear contacts**

You can delete all the entries in the SIM and Phone. This function requires the Security code.

1. Scroll to highlight Clear contacts, and then press the left soft key  [OK].
2. Highlight the memory you wish to erase, and then press the left soft key  [OK].
3. Enter the security code and press the left soft key  [OK] or the right soft key  [Back].

▶ **Service dial number**





Use this function to access a particular list of services provided by your network operator (if supported by the SIM card).

Calendar

Menu 4.2

When you enter this menu a calendar will be displayed. The month and year are shown at the top of the screen. Whenever you change the date under the Settings menu, the calendar will update automatically. The current date will be highlighted in green and any schedule or memos will be indicated with a red triangle at the top left hand corner of the corresponding square. An audible alarm can be set for memo's and reminders.

To change the day, month and year.



Key	Description	Key	Description
	Yearly		Weekly
	Monthly		Daily



In calendar mode, press the left soft key  [Options] as follows;

Add new (Menu 4.2.1)

Allows you to add a new schedule and memo for the chosen day. You can store up to 20 notes. Input the subject and then press left soft key  [OK]. You enter the appropriate information in the following section; **Time**, **Repeat** and **Alarm**.

View daily schedules (Menu 4.2.2)

View all schedules and memo for the chosen day. Use   to browse through the note lists. If you set the alarm for a note, the alarm icon is displayed.

If you want to view the note in detail, press the left soft key  [OK]. Press the left soft key  [Options] to delete or edit the note you have selected.

Delete past (Menu 4.2.3)

You can delete the past schedule that you have already been notified of.

Delete all (Menu 4.2.4)

You can delete all the notes.

Go to date (Menu 4.2.5)



Type and you can go to the chosen date directly.

Set alarm tone (Menu 4.2.6)

You can set the alarm tone for the each chosen date.

Memo

Menu 4.3

1. Select the **Memo** by pressing the left soft key  [OK].
2. If the entry is empty, press the left soft key  [Write].
3. Input the memo and then press the left soft key  [OK].

Note

- ▶ If you want to change the text input mode, press the  in order.

Messages

New message

Menu 5.1

This menu includes functions related to SMS (Short Message Service), MMS (Multimedia Message Service), voice mail, as well as the network's service messages.

Write text message (Menu 5.1.1)

You can write and edit text message, checking the number of message pages.



1. Enter the **New message** menu by pressing the left soft key  [OK].
2. If you want to write a new message, select **Write text message**.
3. To make text input easier, use T9.
4. Press Right soft key [Insert] to attach the following :

Insert

- ▶ **Images:** You can insert the Default graphics or graphics in My pictures that are available for short messages.
- ▶ **Sounds:** You can insert sounds that are available for short messages.

- ▶ **Text templates:** You can use Text templates already set in the phone.
 - ▶ **Contacts:** You can add phone numbers or e-mail addresses in the address book.
 - ▶ **Symbol:** You can add special characters.
 - ▶ **My business card:** You can add your Business card to the message.
5. After you complete the message, to select the required option, press the left soft key  [Options].

Options

- ▶ **Send:** Sends text messages.
1. Enter number(s) of recipient(s).
 2. Press  key to add more recipients (max 6).
 3. You can add phone numbers from the address book.
 4. Once the numbers have been entered, press the left soft key  to send the message. All messages will automatically be saved in the outbox folder, even after a sending failure.
- ▶ **Save to drafts:** Stores messages in the Drafts folder.

- ▶ **Font & Alignment:** You can select the **Size** and **Style** of font, and the **Alignment** of text.
- ▶ **Colour:** You can also set the **Colour** of the text (foreground) and the background.
- ▶ **Add T9 dictionary:** You can add your own words. This menu will only be shown when the edit mode has been set to T9ABC/T9Abc/T9abc.
- ▶ **T9 languages:** Select the desired language for T9 input mode. You can also deactivate the T9 input mode by selecting 'T9 off'.
- ▶ **Exit:** If you press Exit whilst writing a message, you will be taken back to the message menu. Also the written message will not have been saved.

Note

- ▶ This phone supports EMS release 5, so is available to send colour pictures, sounds, text styles, etc.. If the other parties handsets do not support such options, the pictures, sounds or texts sent may not be displayed correctly on their phones.

Write multimedia message

(Menu 5.1.2)

A multimedia message can contain text, images, and/or sound clips. This feature can be used only if it is supported by your network operator or service provider. Only devices that offer compatible multimedia message or e-mail features can receive and send multimedia messages.

1. Enter the **New message** menu by pressing the left soft key  [OK].
2. If you want to write a new message, select **Write multimedia message**.
3. You can create a new message or choose one of the multimedia message templates already stored in phone.
4. Press **Insert** to add Photos, Images, Sounds, Contacts, Symbol, New photo, New sound, Text templates, My business card.

Maximum available file size, that can be inserted to MMS-message, is 1 00 kb.

Messages

Options

- ▶ **Send:** You can send multimedia messages to multiple recipients, as well as save it to send at a later time.

Note

- ▶ All messages will be automatically saved in the outbox folder, even after a sending failure.

- ▶ **Preview:** You can preview multimedia messages you have created.
- ▶ **Save:** You can save multimedia messages **To drafts** or **As template**.
- ▶ **Edit subject:** Allows you to modify the multimedia message you have chosen.
- ▶ **Add slide:** You can add a slide before or after current slide.
- ▶ **Move to slide:** You can move to the previous or the next slide.
- ▶ **Delete slide:** You can delete current folders.

▶ Set slide format

- **Set timer:** You can set a timer for slide, text, picture and sound.
- **Swap text and picture:** You can switch the position of picture and text of the message.
- ▶ **Remove media:** You can remove a picture or sound in the slide. This option can be shown only when any media file has been added.
- ▶ **Add T9 dictionary:** You can add your own words. This menu will only be shown when the edit mode has been set to T9ABC/T9Abc/T9abc.
- ▶ **T9 languages:** Select the desired language for T9 input mode. You can also deactivate T9 input mode by selecting 'T9 off'.
- ▶ **Exit:** Will take you back to the Message menu.







Note

- ▶ When creating a multimedia message, if you upload a picture (50K) you may find that whilst the picture is loading you will not be able to carry out any other actions until the picture has completed loading.

Inbox

Menu 5.2

You will be alerted when you have received a message. They will be stored in the Inbox. In the Inbox, you can identify each message by icons. For detail, see the icon directive.

Icon	Icon directive
	Multimedia message
	Short message
	SIM message
	Read multimedia message
	Read text message
	Push message
	Notified multimedia message

If the phone shows 'No space for SIM message', you only have to delete the SIM messages from the Inbox. If the phone displays 'No space for message', you will then need to delete messages, media or applications to free up space.

*** SIM message**

SIM message means that the message is exceptionally stored in the SIM card. You can move this message to the phone.

When you are notified that you have received a multimedia message, you have to wait for the message to be downloaded before you can view it.

To read a message, select one of the messages by pressing the left soft key  [Options].

- ▶ **View:** You can view the received messages.
- ▶ **Reply:** You can reply to the sender.
- ▶ **Forward:** You can forward the selected message to another party.
- ▶ **Delete:** You can delete the current message.
- ▶ **Return call:** You can call back the sender.

Messages

- ▶ **Information:** You can view information about received messages; Sender's address, Subject (only for Multimedia message), Message date & time, Message type, Message size.
- ▶ **Delete all:** You can delete all messages.

Drafts

Menu 5.3

Using this menu, you can preset up to five multimedia messages that you use most frequently. This menu shows the preset multimedia message list.







The following options are available.

- ▶ **View:** You can see the multimedia messages.
- ▶ **Edit:** Allows you to modify the chosen message.
- ▶ **Delete:** Deletes the message you choose.
- ▶ **Information:** To view the information of the message.
- ▶ **Delete all:** Delete all the messages.

Outbox



Menu 5.4

This menu allows you to view the messages which you have sent, those that are currently sending or messages that have failed sending previously.

Icon	Icon directive
	MMS Unsent
	MMS sent
	MMS delivery confirmed
	SMS unsent
	SMS sent
	SMS delivery confirmed

- ▶ **View:** You can view the message.
- ▶ **Forward:** You can forward the selected message to another party.
- ▶ **Delete:** You can delete the message.
- ▶ **Information:** You can check the information of each message.
- ▶ **Delete all:** You can delete all the messages in the outbox.

Listen to voice mail Menu 5.5

Once this menu has been selected, simply press the left soft key  [OK] to listen to voice mail. You can also hold down the  key in standby mode to listen to voice mail.



Note

- ▶ When you receive a voice mail, your phone will display an icon and you will hear an alert. Please check with your network provider for details of their service in order to configure the handset correctly.

Info message Menu 5.6 (Dependent to network and subscription)

Info service messages are text messages delivered by the network to your handset. They provide general information such as weather reports, traffic news, taxis, pharmacies, and stock prices. When you receive an info service message, you will see a popup message or the info service message is directly displayed. To view the message again follow the sequence shown below;

Read (Menu 5.6.1)

1. When you have received an info service message and select Read to view the message, it will be displayed on the screen. You can read another message by scrolling ,  or  [OK].
2. The message will be shown until another message is selected.

Topics (Menu 5.6.2) (Dependent to network and subscription)

- ▶ **Add new:** You can add Info service message numbers in the Phone memory with its nickname.
- ▶ **View list:** You can see Info service message numbers which you have added. If you press  [Options], you can edit and delete info message categories which you have added.
- ▶ **Active list:** You can select info service message numbers in the active list. If you activate an info service number, you can receive messages sent from that number.

Templates

Menu 5.7

Text templates (Menu 5.7.1)

You have 6 text templates as below;

- **Please call me back.**
- **I'm late. I will be there at**
- **Where are you now?**
- **I am on the way.**
- **Top urgent. Please contact.**
- **I love you.**

Multimedia templates (Menu 5.7.2)

After you have saved a new template, you can use the following options.

- ▶ **View:** You can see multimedia templates.
- ▶ **Delete:** You can delete multimedia templates.
- ▶ **Add new:** Allows you to add new multimedia templates.
- ▶ **Write messages:** You can write and send multimedia messages.

- ▶ **Edit:** You can edit multimedia templates.
- ▶ **Delete all:** Allows you to delete all multimedia messages.

Settings

Menu 5.8

Text message (Menu 5.8.1)

▶ **Message types:**

Text, Voice, Fax, Natl. paging, X.400, Email, ERMES

Usually, the type of message is set to **Text**. You can convert your text into alternative formats. Contact your service provider for the availability of this function.

- ▶ **Validity period:** This network service allows you to set how long your text messages will be stored at the message centre.
- ▶ **Delivery report:** If you set to **Yes**, you can check whether your message is sent successfully.

- ▶ **Reply charging:** When a message is sent, it allows the recipients to reply and charge the cost of the reply to your telephone bill.
- ▶ **SMS centre:** If you want to send the text message, you can receive the address of SMS centre through this menu.

Multimedia message (Menu 5.8.2)

- ▶ **Priority:** You can set the priority of the message you choose.
- ▶ **Validity period:** This network service allows you to set how long your text messages will be stored at the message centre.
- ▶ **Subject:** You can enter multimedia messages subject when this menu is on.
- ▶ **Delivery report:** If it is set to **Yes** in this menu, you can check whether your message is sent successfully.

Messages

- ▶ **Auto retrieve:** If you select **On**, you receive multimedia messages automatically. If you select **Off**, you receive only notification message in the inbox and then you can check this notification. If you select **Home network only**, you receive multimedia messages depends on Home network.
- ▶ **Network settings:** If you select multimedia message server, you can set URL for multimedia message server.
- ▶ **Permitted message types**
 - Personal:** Personal message.
 - Advertisements:** Commercial message.
 - Information:** Necessary information.

Voice mailbox number (Menu 5.8.3)

You can receive voicemail if your network service provider supports this feature. When a new voicemail has arrived, the symbol will be displayed on the screen. Please check with your network service provider for details of their service in order to configure the phone accordingly.

- ▶ **Home:** You can listen to voice mails by selecting Home.
- ▶ **Roaming:** Even when you are abroad, you can listen to voice mails if a roaming service is supported.

Info message (Menu 5.8.4)

▶ Receive

Yes: If you select this menu, your phone will receive Info service messages.

No: If you select this menu, your phone will not receive Info service messages any more.

▶ Alert

Yes: Your phone will beep when you have received Info service message numbers.

No: Your phone will not beep even though you have received info service messages.

▶ Languages

You can select the language you want by pressing [On/Off]. Then, the info service message will be shown in the language that you selected.

Push message (Menu 5.8.5)

You can set the option whether you will receive the message or not.

Multimedia

Camera

Menu 6.1

This application enables you to take a still picture. You can take a picture in your desired size, and use it for the contacts photo, home screen and other more general purposes. Once taken, a still image can be sent via Multimedia msg.

Press the left soft key  to display the following popup menu items.

- ▶ **Brightness:** Determines the brightness.
- ▶ **Size:** Determines the size of an image.
- ▶ **Timer:** Determines the delay time.
- ▶ **Quality:** Determines the quality of an image.
- ▶ **White Balance :** Allows you to change the settings according to the environment.
- ▶ **Album:** Shows the still images taken.
- ▶ **Exit:** To exit the Camera.
- ▶ **Mode:** Determines whether to take a single , multishot or frame shot photo.
- ▶ **Effect:** Determines the special effect to the picture.

- ▶ **Flash:** Determines the flash operation.
- ▶ **Zoom:** Determines the zoom rate.

Note

- ▶ Frame shots are only available with the pixel resolution set to 176 x 220.
- ▶ Multi shots are only available when the pixel resolution is set to 320 x 240 or 640 x 480.
- ▶ To use the Photo Caller ID feature, you must take photos you wish to associate with your contacts in 72x72 resolution.
- ▶ Once the photo has been taken and saved, go to **Contacts** and select the contact you wish to associate the photo to or select **Add new** to create a new contact (please note that a photo can only be associated with a contact stored in the phone's memory and not on the SIM).
- ▶ Select **Edit**. Unless you wish to edit the name, press OK and then use the navigation keys to highlight the picture tab.

Note

- ▶ Use the ◀, ▶ keys to scroll through the photos (please note that only pictures taken in 72 × 72 resolution will be listed here).
- ▶ Once you have selected the photo you wish to use press the left soft key to save this in the contacts profile.
- ▶ The photo will be shown when this particular contact calls you (as long as the contact does not have their telephone number set to hidden).

Video camera

Menu 6.2

This application enables you to record a video clip. You can play and watch a saved video file while using this function.

Press the left soft key  to display the following popup menu items.

- ▶ **Brightness:** Determines the brightness.
- ▶ **Size:** Determines the size of an image.
- ▶ **Timer:** Determines the delay time.

- ▶ **Quality:** Determines the quality of a video clip.
- ▶ **White Balance :** Allows you to change the settings according to the environment.
- ▶ **Record Time:** Determines the recording time.
- ▶ **Exit:** To exit the Video camera.
- ▶ **Effect:** Determines the special effect to the video clip.
- ▶ **Flash:** Determines the flash operation.
- ▶ **Zoom:** Determines the zoom rate.

Voice recorder



Menu 6.3

With the voice memo feature you can record up to 20 voice messages and each memo can be up to 20 seconds long.

Record (Menu 6.3.1)

You can record a voice memo in the Voice recorder menu.

Multimedia

1. Once recording has started, the message Recording and the remaining time is displayed.
2. If you want to finish recording, press the left soft key  [Save].
3. Key in Voice memo title, press the left soft key  [OK].

View list (Menu 6.3.2)

The list of voice memos are displayed. You can playback and delete the recorded voice memo. The following [Options] menus are available

MP3

Menu 6.4

The KG800 has an integrated MP3 player built-in. You can enjoy listening to MP3 music files on your phone memory using a compatible headset or via the internal loudspeaker.

Note

- ▶ Because of the small dimension of the speaker, in some cases the audio could be distorted, especially at maximum volume and when there are lots of bass sounds. Therefore, we recommend you to use the stereo headset in order to appreciate the high quality of your music.

The music player supports:

- MPEG-1 Layer III, MPEG-2 Layer III, MPEG-2.5 Layer III Sampling frequency up from 8KHz to 48KHz. Bit rate up to 320Kbps, stereo.
- AAC: ADIF, ADTS formats (Sampling frequency from 8KHz to 48KHz)
- AAC+: V1 : (Bit rate 16-128Kbps)
V2 : (Bit rate 16-48Kbps)
(Sampling frequency from 8KHz to 48KHz)
- MP4, M4A: Sampling frequency up from 8KHz to 48KHz, Bit rate up to 320Kbps, stereo.
- WMA: Sampling frequency up from 8KHz to 48KHz, Bit rate up to 320Kbps, stereo.

Note

- ▶ KG800 doesn't support the variable rate of MP3 and AAC file. Therefore, you can't change the file from VBR MP3 format to AAC.

You can transfer MP3 files from a compatible PC to the memory in your phone using the Mass Storage. When you connect the phone to a PC using the USB cable (supplied in the same package), this will be displayed as a removable disk through Windows Explorer. If you are using Win98 SE, you will have to install the Mass storage driver for Windows 98 on CD-ROM.

Note

- ▶ You should copy MP3 to my media\Music folder. If you copy to another folder, you will not be able to view the MP3 files.
- ▶ The PC should run Windows 98 SE, Windows ME, Windows 2000, Windows XP operating system.

This menu allows you to view the whole play list. You can move through the tracks by pressing the navigation key. In addition, once you have selected the track, you can delete the file or view its information via the options menu.

1. **Go to MP3 player :** Move to MP3 player.

Press the left soft key  [Options] to access the following menus.

- ▶ **View play list:** You can view the play list while listening to the music.
- ▶ **Area repeat:** The special area part of the current music is repeated when you select ON of the menu.
- ▶ **Set as ring tone:** This menu allows to set the MP3 file as a ring tone. You can also set it as a ring tone in Profile.
- ▶ **Setting**
 - **Equalizer**
This menu helps you to adjust to a variety of environments when listening to music. This phone supports four preset menus. When you enter this menu, you can view current value of equalizer.

Multimedia

- Playmode

This menu allows to set the play mode.

- Set shuffle

You can listen to your MP3 music randomly.

- Visual effect

You can select the visual effect menus: Rainbow, Basic and Blue. This menu allows to change the background of LCD on playing MP3 file.

2. **Delete:** Deletes the file selected.
3. **View details:** To view the information of the file you selected.
4. **Delete all:** Deletes all of the files.

Note

- ▶ Music is copyright protected in international treaties and national copyright laws. It may be necessary to obtain permission or a license to reproduce or copy music. In some countries national law prohibits private copying of copyrighted material. Please check the national legislation of the applicable country concerning the use of such material.

Photo album

Menu 6.5

You can view and send a picture. In addition, you can set the picture as a wallpaper.

- ▶ **Multi view:** You can view the maximum of 9 thumbnails in a screen.
- ▶ **Send via Bluetooth:** You can send a picture by Bluetooth.
- ▶ **Write multimedia message:** You can write and edit multimedia messages, checking message size.
- ▶ **Set as wallpaper:** You can set a picture as a wallpaper.
- ▶ **Slide show:** You can view the pictures in a slide show.
- ▶ **Delete:** You can delete a picture.
- ▶ **Edit title:** You can edit the title of picture.
- ▶ **Information:** Displays information about the saved picture.

Note

- ▶ The Photo Album will only display pictures taken by the handsets camera.

Video album

Menu 6.6

You can view videos which have been saved in the memory.

- ▶ **Play:** You can play the video file when pressing the OK key or selecting Play menu of the Options menu.
- ▶ **Send via Bluetooth:** Send the selected file to another device via Bluetooth.
- ▶ **Rename:** Change the file name of selected file.
- ▶ **Delete:** Delete a file.
- ▶ **Delete all:** Delete all files in the list
- ▶ **Information:** Show the file information.

Settings

Menu 6.7

Camera (Menu 6.7.1)

- ▶ **Auto save:** If you set this feature to On, the images will be saved automatically without displaying the menu bar to save.
- ▶ **Delete all photos:** You can delete all the photos which have been saved in the memory.

Video camera (Menu 6.7.2)

- ▶ **Delete all videos:** Allows you to delete all the videos which have been saved in the memory.

Browser

You can access various WAP (Wireless Application Protocol) services such as banking, news, weather reports and flight information. These services are specially designed for mobile phones and they are maintained by WAP service providers.

Check the availability of WAP services, pricing and tariffs with your network operator and/or the service provider whose service you wish to use. Service providers will also give you instructions on how to use their services.



Once connected, the homepage is displayed. The content depends on the service provider. To exit the browser at any time, press the  key. The phone will return to the idle menu.

Navigating with the WAP browser

You can surf the Internet using either the phone keys or the WAP browser menu.

Using the phone keys

When surfing the Internet, the phone keys function differently to phone mode.

Key	Description
	Scrolls each line of the content area
	Returns to the previous page
	Selects options and confirmations and confirms actions

Using the WAP browser menu

There are various menu options available when surfing the Mobile Web.

Note

- ▶ The WAP browser menus may vary, depending on your browser version.

Home

Menu 7.1

Connects to a homepage. The homepage will be the site which is defined in the activated profile. It will be defined by the service provider if you have not defined it in the activated profile.

Bookmarks

Menu 7.2

This menu allows you to store the URL of favourite web pages for easy access at a later time.

To create a bookmark

1. Press the left soft key  [Options].
2. Select Add new and press the OK key.
3. After entering the desired URL and title, press the OK key.

After selecting a desired bookmark, the following options are available.

- ▶ **Connect:** Connects to the selected bookmark.
- ▶ **Add new:** Select this to create a new bookmark.

- ▶ **Edit:** You can edit the URL and/or the title of the selected bookmark.
- ▶ **Delete:** Deletes the selected bookmark.
- ▶ **Delete all:** Deletes all the bookmarks.

Go to URL

Menu 7.3

You can connect directly to the site you want. After entering a specific URL, press the OK key.

Settings

Menu 7.4

You can set the profile, cache, cookie and security related to internet service.

Profiles (Menu 7.4.1)

A profile is the network information used to connect to the Internet.

There are default profiles for some operators, stored in phone memory. It's impossible to rename default profiles.

Each profile has submenus as follows:

- ▶ **Activate:** Activates the selected profile.
- ▶ **Settings:** Use this to edit and change WAP settings for the selected profile.

- **Homepage:** This setting allows you to enter the address (URL) of a site you want to use as homepage. You do not need to type http:// at the front of each URL as the WAP Browser will automatically add it.

- **Bearer:** You can set the bearer data service. 1 Data/2 GPRS

- **Data settings:** Appears only if you select Data Settings as a Bearer/service.

Dial number: Enter the telephone number to dial to access your WAP gateway.

User ID: The users identity for your dial-up server (and NOT the WAP gateway).

Password: The password required by your dial-up server (and NOT the WAP gateway) to identify you.

Call type: Select the type of data call : Analogue or Digital (ISDN).

Linger time: You need to enter timeout period. After entering that, the WAP navigation service will be unavailable if any data is not input or transferred.

- **GPRS settings:** The service settings are only available when GPRS is chosen as a bearer service.

APN: Input the APN of the GPRS.

User ID: The users identify for your APN server.

Password: The password required by your APN server.

- **Proxy settings**

Proxy: Activates or cancels proxy.

IP address: Input the IP address of the Proxy server you access.

Port number: Input the Proxy Port.

- **DNS settings**

Primary server: Input the IP address of the primary DNS server you access.

Secondary server: Input the IP address of the secondary DNS server you access.

- ▶ **Rename:** You can change the profile name.
- ▶ **Add new:** You can add a new profile.
- ▶ **Delete:** Deletes the selected profile from the list.

Cache (Menu 7.4.2)

The information or services you have accessed are saved in the cache memory of the phone.

Cookie (Menu 7.4.3)

Check whether a cookie is used or not.

Clear cache (Menu 7.4.4)

Removes all context saved in cache.

Note

- ▶ A cache is a buffer memory, which is used to save data temporarily.

Clear cookie (Menu 7.4.5)

Removes all context saved in cookie.

Security (Menu 7.4.6)

A list of the available certification is shown.

- ▶ **Authority:** You can see the list of authority certificates that have been stored in your phone.
- ▶ **Personal:** You can see the list of personal certificates that have been stored in your phone.

My stuff

Games & apps

Menu 8.1

Games & apps (Menu 8.1.1)

- **Default Games:** In this menu, you can manage the Java applications installed in your phone. You can play or delete downloaded applications, or set the connect option. The downloaded applications are organised in folders. Press the left soft key  [OK] to open the selected slide or launch the selected midlet.

After selecting a folder, press [Options] and then sub menus available to several options are displayed.

- ▶ **Open:** You can see the stored games.
- ▶ **New folder:** Create a new slide.

Java™, is a technology developed by Sun Microsystems. Similar to the way you would download the Java Applet using the standard MS Internet Explorer browsers, Java MIDlet can be downloaded using a WAP enabled phone. Depending on the service provider, all Java based programs such as Java games can be downloaded and run on a phone. Once downloaded, the Java program can be viewed in the **Games & Apps** menu where you can select, execute, or delete. The Java program files saved in the phone are in .JAD or .JAR format.

Profiles (Menu 8.1.2)

A profile is the network information used to connect to the Internet.

If you want to see the details of a profile, please refer to Menu 7.4.1.

Note

- ▶ The JAR file is a compressed format of the Java program and the JAD file is a description file that includes all detailed information. From the network, prior to download, you can view all detailed file descriptions from the JAD file.
- ▶ While being based on a standard language (J2ME), not all Java applications are compatible with all handsets on sale insofar as specific libraries may be used for a telephone model. The software may be blocked or switch itself on when Java applications not specifically developed for the phone this manual refers to are downloaded, making it necessary to “restart” the handset. We would like to point out that these problems are caused by incompatible applications and are not a product fault.

CAUTION!

Only J2ME (Java 2 Micro Edition) based programs will run in a phone environment. The J2SE (Java 2 Standard Edition) based programs will only run in a PC environment.

New Fantastic LG There is Mass Storage function in the KG800. if you connect the USB cable, you can use the phone as a Removable Disk.

You can download MP3 files, and photos, video, txt files etc. this gives you fast access from PC to Phone, by just connecting the USB cable.

This function does not require the installation of additional software.

1. Whilst the phone is displaying the standby screen, connect the phone to the PC using the supplied USB cable. The PC should recognise the handset within a few seconds.
2. The phone will display « USB » on the screen.
3. The phone will be identified as « Removable disk » in My Computer. The PC should then treat the KG800 as a standard drive allowing you to place files to and from the handset's memory. You can either use Window's drag and drop or copy and paste methods to transfer content.

My stuff

4. Double click on «Removable disk» and open. A folder called My media will be displayed. Within that folder there are a further 5 folders. Do not disconnect the phone whilst a file transfer is in progress, doing so may damage the memory and corrupt the file.
5. When you want to disconnect the phone from your PC, use Windows to safely remove the hardware and then disconnect the USB cable from the handset.
 - ▶ If you receive a call whilst in mass storage mode, the call will be rejected. Once the handset is disconnected, the KG800 will display information about any calls missed.

My media

In the My media folder you will find the following 5 folders; Music, Others, Photos, Text and Videos.

Do not change the names of these folders, doing so will cause content stored in them to not be seen by the handset.

Music

- ▶ You can store music files in this folder.
- ▶ The supported formats are: MP3, AAC, AAC+, AAC++, WMA, MP4 (audio), Wav.
- ▶ The files in this folder can be played using the MP3 player and Playlist features of the phone.
- ▶ If you download an MP3 file to a different folder, it will be not be possible for the phone to locate and play the file.
- ▶ Do not create subfolders here because the MP3 files contained in that folder will not be found and, therefore, will unable to be played by the music player.
- ▶ To set an MP3 file as a ringtone then please do the following on the handset: options>Go to MP3 player>options>set as ringtone.

Others

- ▶ Any type of file can be stored here. This folder is mainly used for transporting files from one PC to another.
- ▶ The handset can preview JPG (Max 460K), GIF (Max 100K).
- ▶ You can set an image file as wallpaper as long as it does not exceed 30k in size, for other formats please use the PC Suite.

Photos

- ▶ This folder is reserved for pictures taken using the phone's digital camera.
- ▶ Even though photos can be uploaded to this folder from your PC, they will not be available on the phone's photo album or My photos folder. Therefore, we recommend that no photos are uploaded to this folder.

Text

- ▶ This folder supports .txt files. If you place non .txt files here then the handset will not display them.

Videos

- ▶ You can download videos taken with the phone's digital camera onto the PC and upload new videos onto the phone.
- ▶ This folder supports the 3GP file format.
- ▶ You can upload files of any size until the memory is full.
- ▶ Files stored in this folder can be accessed by doing the following on the handset: Menu>Multimedia>Video album.

Videos

Menu 8.2

Show the list of 3GP and MP4 files .

- ▶ **Play:** You can play the video file by pressing the OK key or selecting Play from the Option menu.
- ▶ **Send via Bluetooth:** Send the selected file to another device via Bluetooth.
- ▶ **Rename:** change the file name of the selected file. The maximum length of characters is 200. And You can not change the extension of file.

WARNING!

*The following characters, \/: * ? " < > | can not be used.*

- ▶ **Delete:** Delete a file.
- ▶ **Delete all:** Deletes all the files in the list
- ▶ **Information:** Shows the file information.

Photos

Menu 8.3

Shows the list of JPG files.

- ▶ **View:** You can see the JPG file by pressing the OK key or selecting View from the Option menu.

Note

- ▶ The maximum size of JPG file you can see is 460Kbytes.

- ▶ **Send via multimedia message:** You can write and send multimedia messages.
- ▶ **Send via Bluetooth:** Send the selected file to another device via Bluetooth.

Note

- ▶ To setup .JPG (.JPEG) file from Photo slide as wallpaper, go to Menu-Multimedia-Photo album and then please select Set as wallpaper in Options menu.

- ▶ **Rename:** change the file name of selected file. The maximum length of characters is 200. And You can not change the extension of file.
- ▶ **Delete:** Delete a file.
- ▶ **Delete all:** Deletes all the files in the list
- ▶ **Information:** Shows the file information.

Music

Menu 8.4

Shows the list of MP3, MP4, AAC, M4A and WMA files.

- ▶ **Play:** You can play the MP3 file by pressing the OK key or selecting Play from the Option menu.
- ▶ **Send via Bluetooth:** Send the selected file to another device via Bluetooth
- ▶ **Rename:** change the file name of selected file. The maximum length of characters is 100. And You can not change the extension of file.
- ▶ **Delete:** Delete a file.

- ▶ **Delete all:** Deletes all files in the list
- ▶ **Information:** Shows the file information.

Text

Menu 8.5

Show the list of TXT files.

- ▶ **View:** You can see the TXT file by pressing the OK key or selecting View from the Option menu.

Note

- ▶ The maximum size of TXT file you can see is 460Kbytes.

- ▶ **Send via Bluetooth:** Send the selected file to another device via Bluetooth.
- ▶ **Rename:** change the file name of selected file. The maximum length of characters is 100. And You can not change the extension of file.
- ▶ **Delete:** Delete a file.
- ▶ **Delete all:** Delete all files in the list
- ▶ **Information:** Show the file information.

Images

Menu 8.6

After selecting a image, press the left key  [View] and then you can check the options as follow:

- ▶ **Set as wallpaper:** Currently selected image can be set as a wallpaper.
- ▶ **Write messages:** The images downloaded from the network can be sent by Multimedia. Maximum message size is 100 kb for MMS message.
- ▶ **Send via Bluetooth:** The sound downloaded from network can be sent by Bluetooth.

Sounds

Menu 8.7

After selecting a sound, press the left key [Options].

You can check the options as follow:

- ▶ **Set as ringtone:** Currently selected sound can be set as a ringtone.
- ▶ **Write messages:** The sound downloaded from network can be sent by SMS or MMS. Maximum MMS message is 100 kb.
- ▶ **Send via Bluetooth:** The sound downloaded from network can be sent by Bluetooth.

Others

Menu 8.8

Any type of file can be stored here. This folder is mainly used for transporting files from one PC to another.

- ▶ **View:** You can view a file if it is one of the following types; JPG, GIF, WBMP, PNG and TXT. The handset can preview JPG (Max 460K), GIF (Max 100K).
- ▶ **Send via Bluetooth:** Send the selected file to another device via Bluetooth

Settings

Date & time

Menu 9.1

You can set functions relating to the date and time.

Date (Menu 9.1.1)

Set date

You can enter the current date.

Date format

You can set the Date format such as DD/MM/YYYY, MM/DD/YYYY, YYYY/MM/DD.
(D: Day / M: Month / Y: Year)

Time (Menu 9.1.2)

Set time

You can enter the current time.

Time format



You can set the time format between 24-hour and 12-hour.

Display

MENU 9.2

Wallpaper (Menu 9.2.1)

You can select the background pictures in standby mode.

- ▶ **Default:** You can select a picture or an animation of wallpaper by pressing  or .
- ▶ **My folder:** You can select a picture or an animation as wallpaper.

Menu colour (Menu 9.2.2)

Your phone provides you with 2 menu colour themes. Set the menu colour by scrolling and pressing the left soft key  [OK].

Standby text (Menu 9.2.3)

If you select **On**, you can edit the text which is displayed in standby mode.

Backlight (Menu 9.2.4)

You can set the light-up duration of the display.

Brightness (Menu 9.2.5)

The screen brightness can be adjusted from 40% to 100%.

Network name (Menu 9.2.6)

If this function is activated, network name will be displayed on main LCD.

Home screen shortcut (Menu 9.2.7)

Selecting On displays the functionalities of 4 Navigation keys and Menu key as pictures on the middle of the idle window.

Dial font colour (Menu 9.2.8)

You can set the colour of displayed number when press the number keys in idle state for call connection.

Power saving

Menu 9.3

This function saves battery power by keeping backlight brightness to max 40%.

Language

Menu 9.4

You can change the language for the display texts in your phone. This change will also affect the Language Input mode.

Connectivity

Menu 9.5

Bluetooth (Menu 9.5.1)

Bluetooth enables compatible mobile devices, peripherals and computers that are in close proximity to communicate directly with each other without wires. This handset supports built-in Bluetooth connectivity, which makes it possible to connect them with compatible Bluetooth headsets, computer applications and so on.

Note

- ▶ If you use LG PC Sync via Bluetooth, you can exchange data only within the phonebook.
- ▶ When you receive data from another Bluetooth device, the phone requests confirmation. After confirming the transfer, the file will be copied on to your phone.
- ▶ Depending on the file type, it will be stored in the following folders:
 - **MP3 (.mp3, mp4, aac, m4a, wma):** Music folder.
 - **Video (.3GP, MP4):** video folder.
 - **Phonebook contacts (.VCF):** Phonebook.
 - **Text (.txt):** Text folder.
 - **Other files (*.*):** File storage folder.
- ▶ The handset normally operates with WIDCOMM driver(version 1.4.3.4) or WIDCOMM driver(version 1.4.2.10). And it does not support the LG Contents Bank with Bluetooth.

Set Bluetooth

You can activate or cancel the Bluetooth function.

Paired devices/Handsfree devices

You can view all devices which your KG800 is already paired to.

If you have entered Paired devices or Handsfree devices, you will see the following options in both those menus.

- ▶ **Connect/Disconnect:** Allows you to connect to your paired Bluetooth devices.
- ▶ **Add new:** Allows you to search for new Bluetooth devices and add them to your phone's list of paired devices. When you select **Add new** your handset will start to search for Bluetooth devices within range. Once the device you wish to pair appears on the list press the right soft key [Stop].
Scroll to the desired device and press the left soft key [Pair]. You will then be asked to enter a passcode. The passcode can be any code you wish to use (the same passcode must be used by both devices) or is one that is pre-determined by the

manufacturer of the device you are trying to pair with. Please check the User Manual of the device you are initiating the pair with to see if it already has a predetermined passcode in place.

- ▶ **Assign name:** Allows you to change the name of the paired Bluetooth device and how it is displayed on the handset.
- ▶ **Set as authorised/Set as unauthorised:** Allows you to set an authorised connection between each Bluetooth device. For example if you regularly use a Bluetooth headset with your phone then setting the connection as authorised will mean the headset will automatically connect to the handset each time the headset is powered on.
- ▶ **All services:** Allows you to view all services which are supported by a Bluetooth device.
- ▶ **Delete:** Allows you to delete a paired Bluetooth device.

- ▶ **Delete all:** Allows you to delete all paired Bluetooth devices.

Settings

▶ My handset's visibility

This indicates whether or not your handset will be visible to other Bluetooth devices.

▶ My handset's name

You can set the name of your Bluetooth device. The default name is LG KG800.

Supported services

Displays a list of Bluetooth services the handset supports.

- ▶ **Headset**
- ▶ **Handsfree kit**
- ▶ **File transfer**
- ▶ **Image printing**
- ▶ **Dial-up networking**
- ▶ **Business card transfer**
- ▶ **Browsing other device**
- ▶ **Serial Port Profile**

Settings

Modem (Menu 9.5.2)

You can access the network services through the Modem. If you want to use the LG PC Sync, Contents bank or Internet Cube, you should access the menu and activate the modem and then plug in the USB cable.

Network (Menu 9.5.3)

You can select a network which will be registered either automatically or manually. Usually, the network selection is set to **Automatic**.

Network selection

You can select a network type.

- ▶ **Automatic:** If you select Automatic mode, the phone will automatically search for and select a network for you. Once you have selected “Automatic”, the phone will be set to “Automatic” even though the power is off and on.

- ▶ **Manual:** The phone will find the list of available networks and show you them. Then you can select the network which you want to use if this network has a roaming agreement with your home network operator. The phone let you select another network if the phone fails to access the selected network.
- ▶ **Preferred:** You can set a list of preferred networks and the phone attempts to register with first, before attempting to register to any other networks. This list is set from the phone’s predefined list of known networks.

Band selection

- ▶ **EGSM/DCS:** Depending on Network situation, you can select EGSM/DCS.
- ▶ **PCS only:** Depending on Network situation, you can select PCS only.

GPRS attach (Menu 9.5.4)

You can set GPRS service depending on various situations.

Switch on

If you select this menu, the phone is automatically registered to a GPRS network when you switch the phone on. Starting a WAP or PC dial-up application created the connection between phone and network and data transfer is possible. When you end the application, GPRS connection is ended but the registration to the GPRS network remains.

When needed

If you select this menu, the GPRS connection is established when you connect a WAP service and closed when you end the WAP connection.

Calling

Menu 9.6

Call divert (Menu 9.6.1)

The Call divert service allows you to divert incoming voice calls, fax calls, and data calls to another number. For details, contact your service provider.

▶ All voice calls

Diverts voice calls unconditionally.

▶ If busy

Diverts voice calls when the phone is in use.

▶ If no reply

Diverts voice calls which you do not answer.

▶ If out of reach

Diverts voice calls when the phone is switched off or out of coverage.

▶ All data calls

Diverts to a number with a PC connection unconditionally.

Settings

▶ All fax calls

Diverts to a number with a fax connection unconditionally.

▶ Cancel all

Cancels all call divert service.

The submenus

Call divert menus have the submenus shown below.

• Activate

Activate the corresponding service.

To voice mail centre

Forwards to message centre. This function is not shown at All data calls and All fax calls menus.

To other number

Inputs the number for diverting.

To favourite number

You can check back to last five diverted numbers.

• Cancel

Deactivate the corresponding service.

• View status

View the status of the corresponding service.

Answer mode (Menu 9.6.2)

▶ Slide up

If you select this menu, you can receive an incoming call when you open the slide.

▶ Any key

If you select this menu, you can receive a call by pressing any key except  [End] key.

▶ Send key only

If you select this menu, you can receive a call by only pressing  [Send] key.

Send my number (Menu 9.6.3) (network and subscription dependent)

▶ Set by network

If you select this, you can send your phone number depending on two line service such as line 1 or line 2.

▶ **On**

You can send your phone number to another party. Your phone number will be shown on the receiver's phone.

▶ **Off**

Your phone number will not be shown.

Call waiting (Menu 9.6.4) (network dependent)

▶ **Activate**

If you select Activate, you can accept a waiting (receiving) call.

▶ **Cancel**

If you select Cancel, you cannot recognize the waiting (receiving) call.

▶ **View status**

Shows the status of Call waiting.

Minute minder (Menu 9.6.5)

If you select On, you can check the call duration by a beep sound given every minute during a call.

Auto redial (Menu 9.6.6)

▶ **On**

When this function is activated, the phone will automatically try to redial in the case of failure to connect a call.

▶ **Off**

Your phone will not make any attempts to redial when the original call has not connected.

Security

Menu 9.7

PIN code request (Menu 9.7.1)

In this menu, you can set the phone to ask for the PIN code of your SIM card when the phone is switched on.

If this function is activated, you'll be requested to enter the PIN code.

1. Select PIN code request in the security settings menu, and then press  [OK].
2. Set **Enable/Disable**

Settings

3. If you want to change the setting, you need to enter PIN code when you switch on the phone.
4. If you enter wrong PIN code more than 3 times, the phone will lock out. If the PIN is blocked, you will need to key in PUK code.
5. You can enter your PUK code up to 10 times. If you put wrong PUK code more than 10 times, you can not unlock your phone. You will need to contact your service provider.

Handset lock (Menu 9.7.2)

You can use a security code to avoid unauthorised use of the phone. Whenever you switch on the phone, the phone will request security code if you set phone lock to **When switch on**.

If you set phone lock to **When SIM changed**, your phone will request security code only when you change your SIM card.

Call barring (Menu 9.7.3)

The Call barring service prevents your phone from making or receiving certain category of

calls. This function requires the call barring password. You can view the following submenus.

▶ All outgoing calls

The barring service for all outgoing calls.

▶ Outgoing international

The barring service for all outgoing international calls.

▶ Outgoing international when roaming

The barring service for all international outgoing calls except home network.

▶ All incoming

The barring service for all incoming calls.

▶ Incoming when roaming

The barring service for all incoming calls when roaming.

▶ Cancel all

You can cancel all barring services.

▶ Change password

You can change the password for Call Barring Service.

The submenus:

- **Activate**

Allows to request the network to set call restriction on.

- **Cancel**

Set the selected call restriction off.

- **View status**

View the status whether the calls are barred or not.

Fixed dial number (Menu 9.7.4) (SIM dependent)

You can restrict your outgoing calls to selected phone numbers. The numbers are protected by your PIN2 code. The numbers you wish to allow access to once this service has been enabled, must be added to the contacts after enabling Fixed dial number.

- ▶ **Enable**

You can restrict your outgoing calls to selected phone numbers.

- ▶ **Disable**

You can cancel fixed dialling function.

- ▶ **Number list**

You can view the number list saved as Fixed dial number.

Change codes (Menu 9.7.5)

PIN is an abbreviation of Personal Identification Number to prevent use by unauthorised person. You can change the access codes: **Security code**, **PIN code**, **PIN2 code**.

1. If you want to change the Security code/PIN1 / PIN2 code input your original code, and then press  [OK].
2. Input new Security code/PIN1 / PIN2 code and verify them.

Touchpad lock (Menu 9.7.6)

Sets whether to use the touch pad when closing a slide.

On: It is impossible to activate the touch pad with slide closed. (You can use the touch pad only when slide opens.)

Off: It is possible to activate the touch pad using the Volume key even with slide closed.

Settings

Memory status

Menu 9.8

You can check free space and memory usage of each repository, Internal memory, Multimedia memory. You can go to each repository menu.

Reset settings

Menu 9.9

You can initialise all factory defaults. You will need the Security code to activate this function.

- ▶ **Restore default settings:** Allows you to restore the phone back to its default settings.
- ▶ **Clear multimedia memory:** Allows you to format the multimedia memory and create a default directory.

There are various accessories for your mobile phone. You can select these options according to your personal communication requirements.

Travel Adapter

This charger allows you to charge the battery.



Standard Battery



Data cable/CD

You can connect your phone to PC to exchange the data between them.



Hands free ear-microphone and music player controller combo



Stereo headset

Controller: Answer & End button, music player control, volume control, Hold button and microphone.

After connecting the headset and the controller, plug the end of controller into the headset jack on the right side of the phone.

Note

- ▶ Always use genuine LG accessories.
- ▶ Failure to do so may invalidate your warranty.
- ▶ Accessories may vary in different regions; please check with our regional service company or agent for further information.

Technical Data

General

Product name: KG800

System : GSM 900 / DCS 1800 / PCS 1900

Ambient Temperatures

Max: +55°C

Min: -10°C

Declaration of Conformity



LG Electronics

Suppliers Details

Name

LG Electronics Inc

Address

: LG Twin Tower 20, Yeouido-dong, Yeongdeungpo-gu Seoul, Korea 150-721

Product Details

Product Name

E-GSM 900 / DCS 1800 / PCS 1900 Tri Band Terminal Equipment

Model Name

KG800/KG808/MG800C

Trade Name

LG

CE 0168

Applicable Standards Details

R&TTE Directive 1999/5/EC

EN 301 489-01 v1.6.1 / EN 301 489-07 v1.3.1 / EN 301 489-17 v.1.2.1
EN 300 328 V 1.6.1
EN 60950-1 : 2001
EN 50360/EN 50361 : 2001
3GPP TS 51.010-1, EN 301 511 V0.0.2

Supplementary Information

The conformity to above standards is verified by BAST.

Declaration

I hereby declare under our sole responsibility that the product mentioned above to which this declaration relates complies with the above mentioned standards and Directives

Name

Issued Date

Jin Seog, Kim / Director

27.Feb. 2006

Signature of representative

LG Electronics Inc. Amsterdam Office
Veluwezoom 15, 1327 AE Almere, The Netherlands
Tel : +31 - 36- 547 - 8940, e-mail : seoljm @ lge.com