



LG

Life's Good

ENGLISH

OWNER'S MANUAL MONITOR SIGNAGE

Please read this manual carefully before operating your set and retain it for future reference.

MONITOR SIGNAGE MODELS

M3204C

M4716C

www.lg.com

Table of Contents

Accessories	3
Connecting the stand	4
Connecting the Speakers	6
To install Portrait	7
Using the Remote Control	8
Name and Function of the Parts	10
Connecting to External Devices	12
When Connecting to your PC.....	12
When using the LAN.....	14
Daisy Chain Monitors	15
VESA FDMI wall Mounting	16
Cable Management	17
Video Input	18
Component Input (480i/480p/576i/576p/720p/1080i/1080p)	19
HDMI Input (480p/576p/720p/1080i/1080p)	20
User Menus	21
Screen Adjustment options	21
OSD Menu	23
How to adjust the OSD (On Screen Display) screen	24
How to adjust the screen automatically	24
Adjusting Screen Color.....	25
Adjusting the audio function.....	31
Adjusting the timer function.....	32
Selecting the options	33
Adjusts the tile options.	35
Adjusts the USB options.....	37
Troubleshooting	51
Specifications	54
Controlling the Multiple Product	A1

Accessories

Accessories

Thank you for your purchase. Please check the product as well as the accessories shown below

❖ Note that the accessories may look different from those shown here.



Remote Control / Batteries



D-Sub Signal Cable



Power Cable



CD-ROM / Cards

Separate purchase

Without prior notice, optional accessories are subject to change to improve the performance of the product, and new accessories may be added.

❖ Optional accessories (purchased separately) may vary depending on the model.

❖ Note that optional accessories may look different from those shown here.

❖ You can obtain additional accessories from most electronics stores.

Stand hole cover Kit < M4716C Only >



Stand hole cover



Screws (2)

Stand Kit

< M3204C >

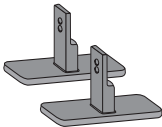

Stand (2)



Screws (4)

< M4716C >

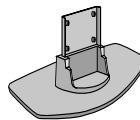

Stand(1)



Screws (4)



Cable management (1)

Speaker Kit

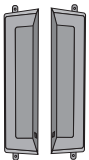

Speaker(2)



Screws (4) / Cable (2)

Cable holder/Cable tie



They may not be available in some areas or for some models.

NC2000 Kit



NC2000



CD-ROM / Cards



Screws (2)

Connecting the stand

- Only on some models.

< M3204C >

1. Take the parts for the stand out of the box and assemble them as shown in the picture.

Parts

First, check if the following parts are all present.



Screws (4)

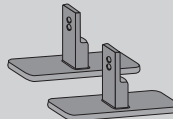

Stand (2)

2. Place a soft cloth on the table and put the product with the screen facing downward. Connect the stand as shown in the following picture.

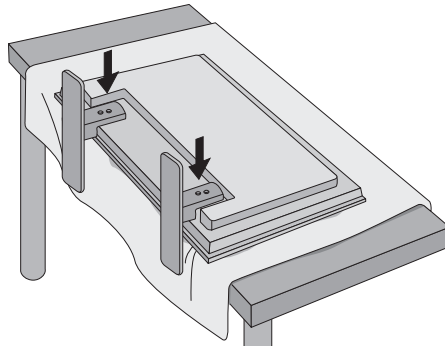

3. Use the screws to secure the stand on the rear side of the product as shown in the diagram.

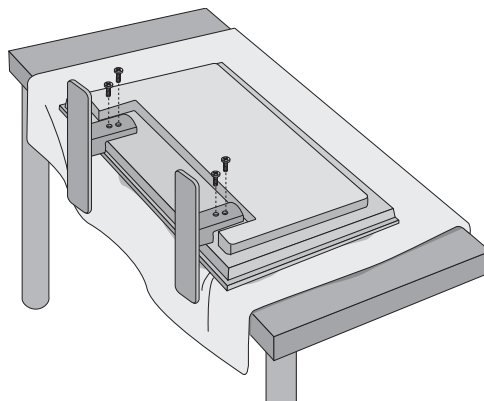

Connecting the stand

- Only on some models.

< M4716C >

1. Take the parts for the stand out of the box and assemble them as shown in the picture.

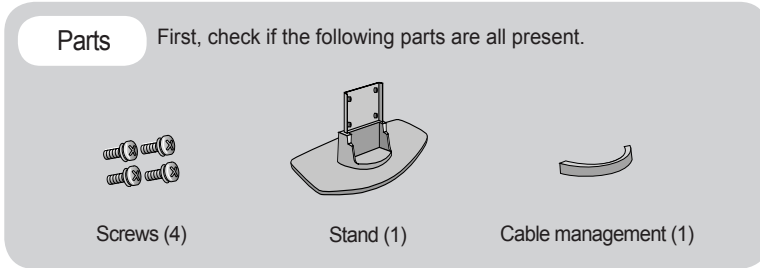

2. Place a soft cloth on the table and put the product with the screen facing downward. Connect the stand as shown in the following picture.

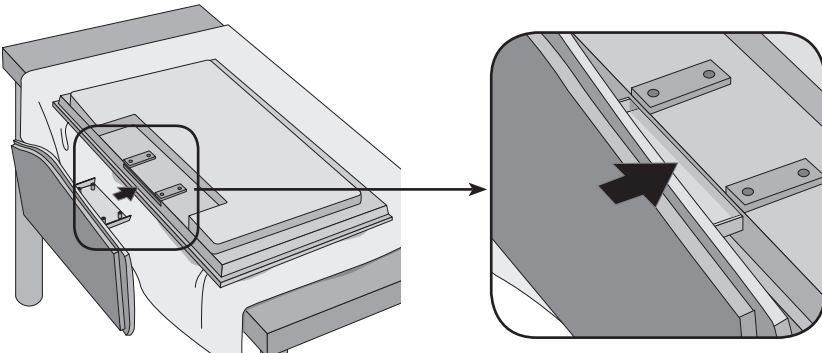

3. Use the screws to secure the stand on the rear side of the product as shown in the diagram.

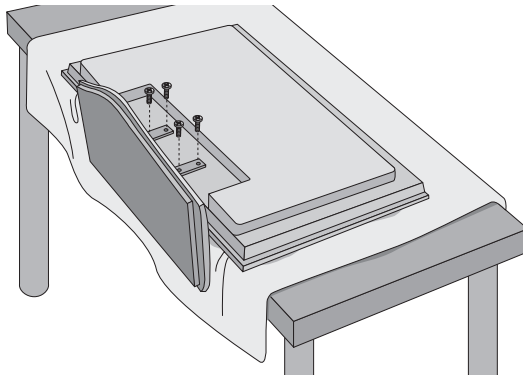

Connecting the Speakers

- Only on some models.

Mount the product onto the speaker by using a screw as shown in the following connect the speaker cable.

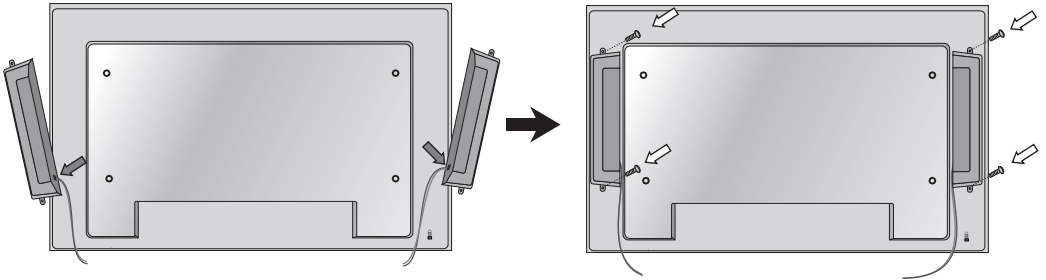

After installing your speakers, use holders and cable ties to organize the speaker cables.

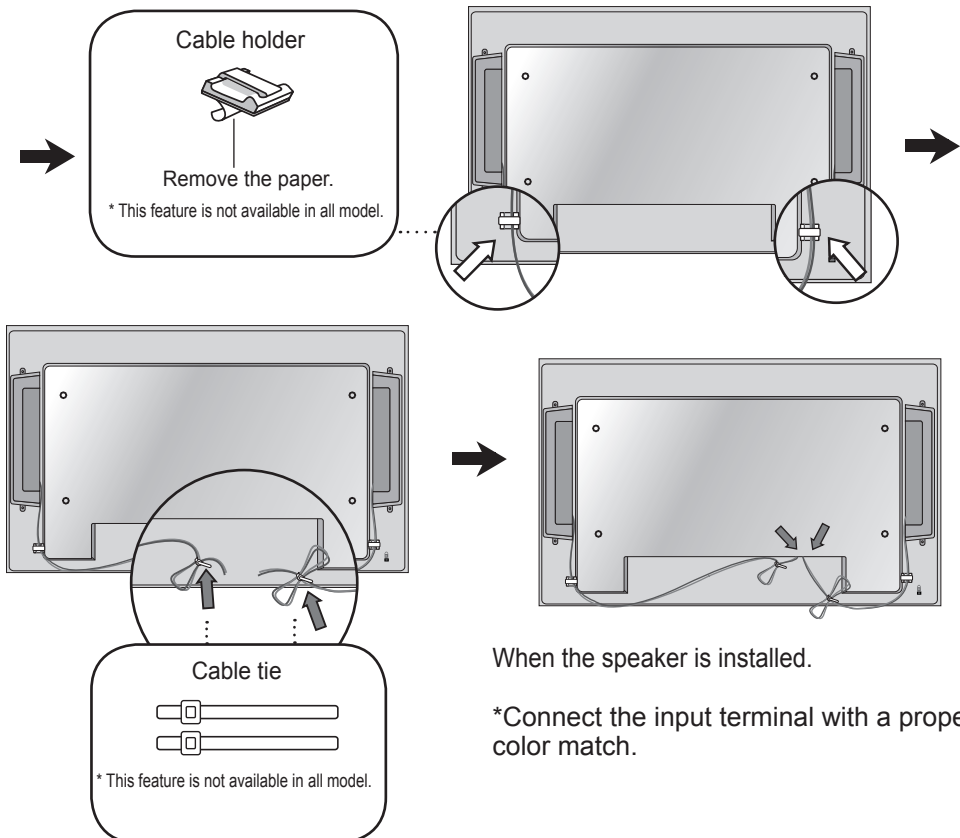

To install Portrait

- Only on some models.

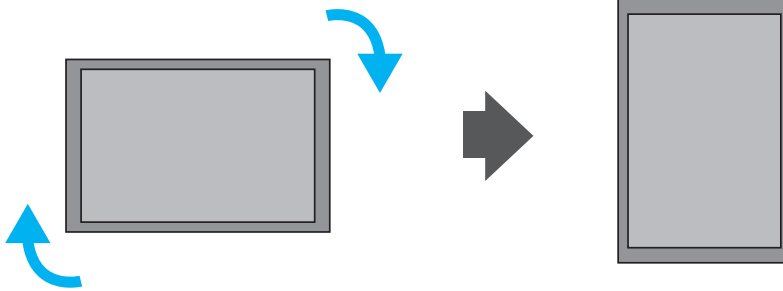

"When installing Portrait, rotate it clockwise based on its front."



Note

< Only M4716C >

- When using the wall mounting bracket or the portrait scene mode, the opening can be covered by the stand hole cover.

Using the Remote Control

● Name of the Remote Control Buttons

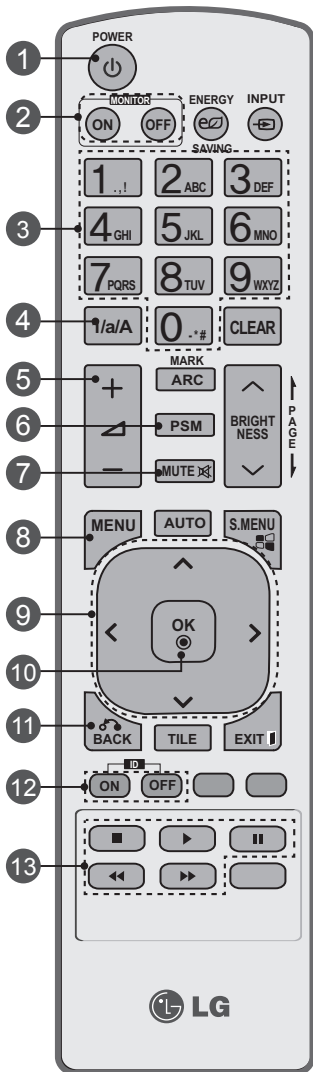

- 1 Power On / Off Button**
- Switches the set on from standby or off to standby.
- 2 Monitor On / Off Button**
- Turn off the monitor and then turn it back on.
- 3 Number and Alphabet Buttons**
- Type numbers and alphabets.
- 4 1/a/A Button**
- Selects the number and alphabet.(SuperSign input only)
- 5 Volume Up/Down Button**
- Adjusts the volume.
- 6 PSM Button**
- Selects the Picture Status Mode.
- 7 MUTE Button**
- Switches the sound on or off.
- 8 MENU Button**
- Selects a menu.
- Clears all on-screen displays and returns to TV viewing from any menu.
- 9 Up/Down/Left/Right Buttons**
- Allows you to navigate the on-screen menus and adjust the system settings to your preferenc.
- 10 OK Button**
- Accepts your selection or displays the current mode.
- 11 BACK button**
- Allows the user to move return one step in an interactive application.
- 12 ID ON/OFF Button**
- When the number of input ID is equal to the number of ID Mode, you can control the monitor which you want in the multi display condition.
- 13 USB Menu control buttons**
- Adjust the USB menu(Photo List, Music List and Movie List).

Using the Remote Control

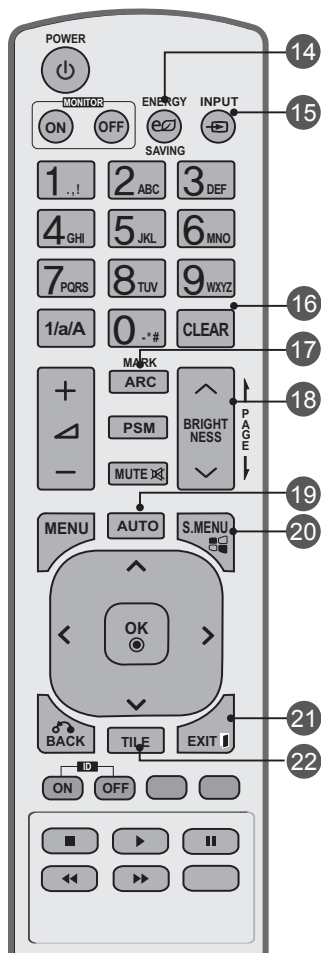

14 Energy Saving Button
- Adjust the Energy Saving mode of the SET.

15 INPUT Select Button
If you press the button once, the following Input Signal Window will appear. Select the signal type you want using the < > button.



16 Clear button
- Delete the numbers and alphabets you typed.(SuperSign input only)

17 ARC Button
- Selects the Aspect Ratio Mode

18 Brightness Key
- Adjust the brightness by pressing the Up and Down buttons on the remote control.
- In USB mode, the OSD menu has the Page function to move to the next file list.

19 AUTO Button
- Automatically adjusts picture position and minimizes image instability.(RGB input only)

20 S.MENU Button (SuperSign Menu Key)
- Selects the SuperSign OSD Menu.
(SuperSign input only)

21 EXIT Button
- Clears all on-screen displays and returns to monitor viewing from any menu.

22 TILE button
- Selects the TILE Mode

Inserting batteries into remote control.

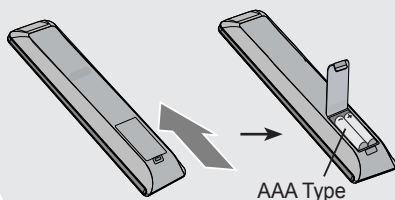

1. Slide off the battery cover.
 2. Insert the batteries with correct polarity (+ / -).
 3. Close the battery cover.
 4. To remove the batteries, perform the installation actions in reverse.
- Dispose of used batteries in the recycle bin to prevent environmental pollution.

Name and Function of the Parts

* The product image in the user's guide could be different from the actual image.

Rear View

< M3204C >

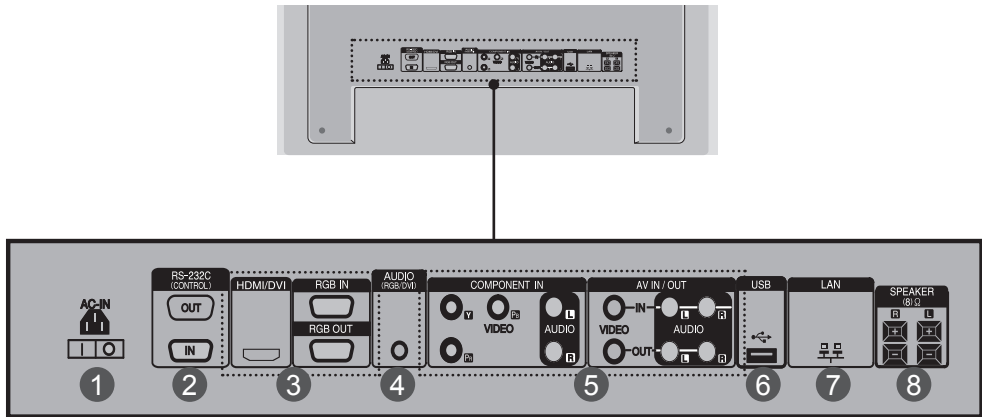

- 1 Power Connector**
Connect the power cord
- 2 RS-232C Serial Ports**
- 3 RGB, HDMI/DVI Ports**
HDMI Supports High Definition input and HDCP (High-bandwidth Digital Content Protection). Some devices require HDCP in order to display HD signals.
- 4 PC Sound Jack**
Connect the audio cable to the *LINE OUT jack of the PC sound card.
- 5 Component, AV Ports**
- 6 USB Port**
- 7 LAN Port**
- 8 Speaker Ports**

* LINE OUT

A terminal used to connect to the speaker including a built-in amplifier (Amp). Make sure that the connecting terminal of the PC sound card is checked before connecting. If the Audio Out of PC sound card has only Speaker Out, reduce the PC volume. If the Audio Out of the PC sound card supports both Speaker Out and Line Out, convert to Line Out using the card jumper of the program (Refer to the Sound Card Manual).

Name and Function of the Parts

* The product image in the user's guide could be different from the actual image.

Rear View

< M4716C >

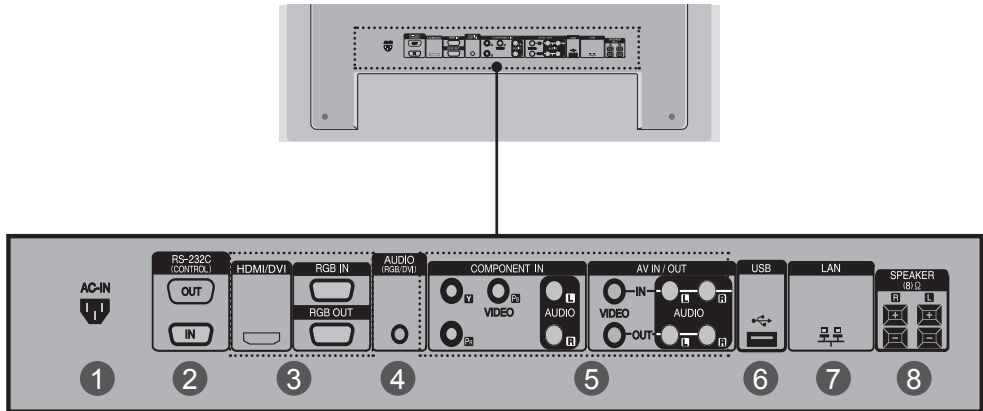

- 1 Power Connector**
Connect the power cord
- 2 RS-232C Serial Ports**
- 3 RGB, HDMI/DVI Ports**
HDMI Supports High Definition input and HDCP (High-bandwidth Digital Content Protection). Some devices require HDCP in order to display HD signals.
- 4 PC Sound Jack**
Connect the audio cable to the *LINE OUT jack of the PC sound card.
- 5 Component, AV Ports**
- 6 USB Port**
- 7 LAN Port**
- 8 Speaker Ports**

* LINE OUT

A terminal used to connect to the speaker including a built-in amplifier (Amp). Make sure that the connecting terminal of the PC sound card is checked before connecting. If the Audio Out of PC sound card has only Speaker Out, reduce the PC volume. If the Audio Out of the PC sound card supports both Speaker Out and Line Out, convert to Line Out using the card jumper of the program (Refer to the Sound Card Manual).

Connecting to External Devices

● When Connecting to your PC

1 First of all, see if the computer, product and the peripherals are turned off. Then, connect the signal input cable.

A. When connecting with the D-Sub signal input cable.

B. When connecting with the HDMI-DVI signal input cable (not included).
* When HDMI PC is used, a compatibility problem might occur.

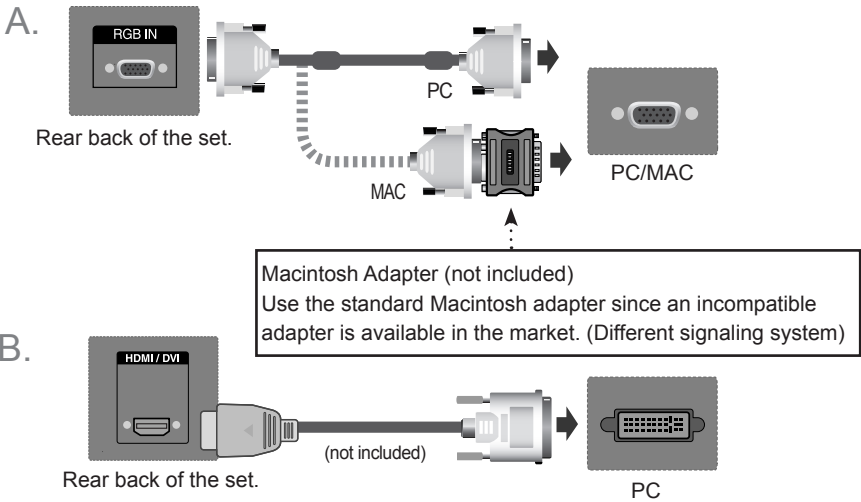

* User must use shielded signal interface cables (D-sub 15 pin cable, HDMI-DVI cable) with ferrite cores to maintain standard compliance for the product.

2 Connect the Audio cable.

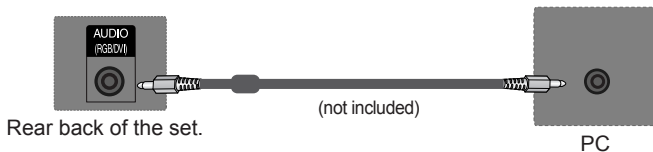

3 Connect the power cord.

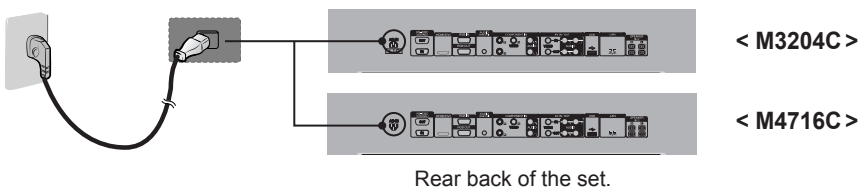

Connecting to External Devices

- 4 1. Turn on power by pressing the power button on the product.

< M3204C >



On/Off button

< M4716C >



On/Off button

2. Turn on the PC.

- 5 Select an input signal.
Press the **INPUT** button on the remote control to select the input signal.

INPUT → < > → **OK**

Or, press the **INPUT** button on the back of the product.

INPUT → ◀ ▶ → **AUTO/SET**

- A. When connecting with a D-Sub signal input cable.
• Select **RGB** : 15-pin D-Sub analog signal.

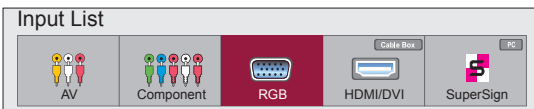

- B. When connecting with a HDMI-DVI signal input cable and HDMI Signal Cable.
• Select **HDMI/DVI** : DVI Digital signal or HDMI Digital signal.

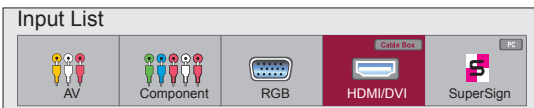

Note



- How to connect to two computers.
Connect the signal cables (HDMI-DVI and D-Sub) to each computer.
Press the **INPUT** button on the remote control to select the computer to use.
- Directly connect to a grounded power outlet on the wall or a power bar with a ground wire.

Connecting to External Devices

● When using the LAN

1 Connect the LAN cable as shown in the below figure .

A. Connect PC to Monitor directly.

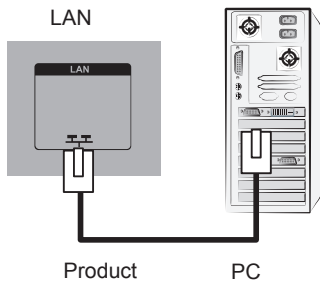

B. Using a router(Switch)

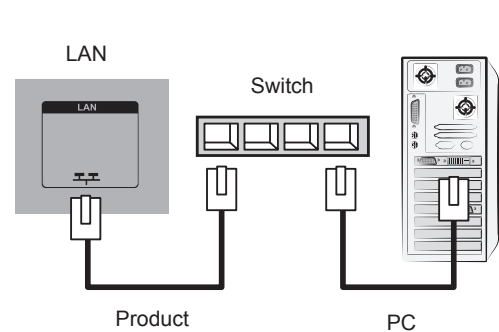

C. Using the Internet.

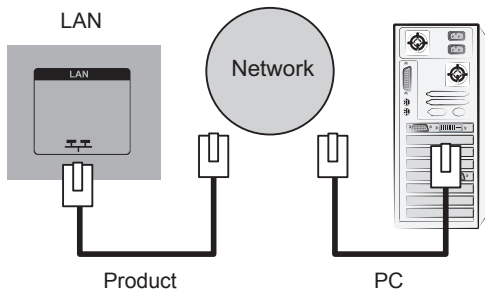

2 Connect the LAN cable and install the eZ-Net Manager program on the CD-ROM. For more information about the program, please refer to eZ-Net Guide in the enclosed CD-ROM.



Note

- Using LAN establishes communication between your PC and the monitor and enables to use the OSD menus on the PC as well as on the monitor.

Connecting to External Devices

● Daisy Chain Monitors

A. When using RGB input

To use different products connected to each other Connect one end of the signal input cable (15-pin D-Sub Signal Cable) to the RGB OUT connector of product 1 and connect the other end to the RGB IN connector of other products.

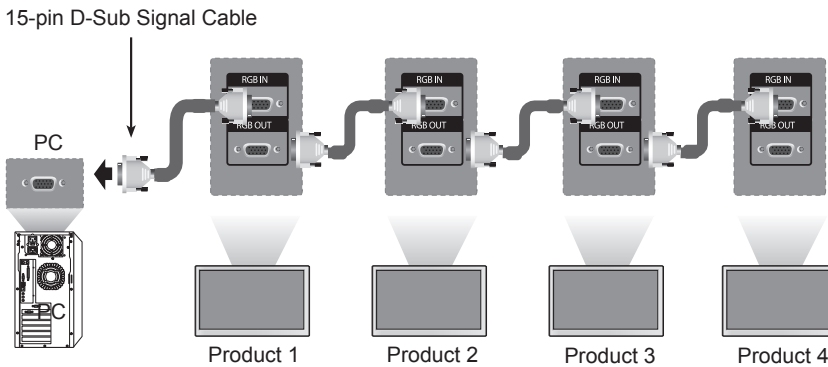

B. When using AV input

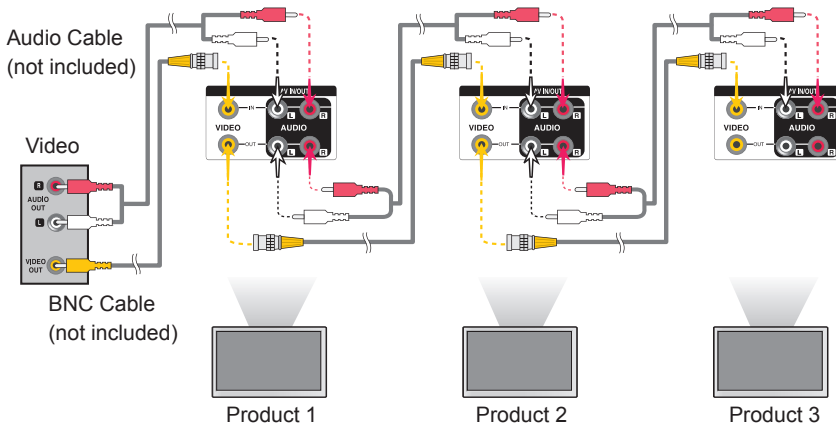

Note



- The number of monitors that can be connected to one output may vary depending on signal status and cable loss. If the signal status is good, and there is no cable loss, it is possible to connect up to 9 monitors. If you want to connect more than this number of monitors, it is recommended to use a distributor.

Connecting to External Devices

● VESA FDMI wall Mounting

This product supports a VESA FDMI compliant mounting interface. These mounts are purchased separately and not available from LG. Refer to the instructions included with wall mount for more info.

< M3204C >

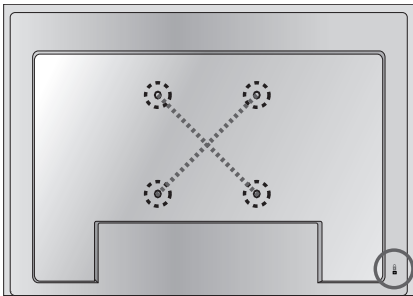

< M4716C >

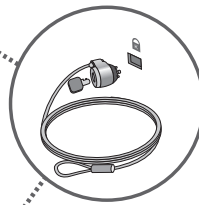
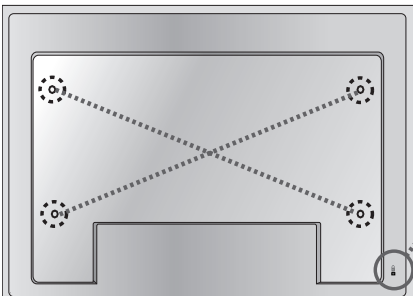

Kensington Security Slot

The Set is equipped with a Kensington Security System connector on the back panel. The cable and lock are available separately and are not sold by LG. For more info, visit <http://www.kensington.com>, the internet home page of the Kensington company.



Note

- There is a switch on the lower side of the back. You can set the switch to "On" before connecting a power cord to make it more convenient for use.

Connecting to External Devices

● Cable Management

- Only on some models.

< Only M4716C >

1. Arrange the cables in the center as shown in the following picture.

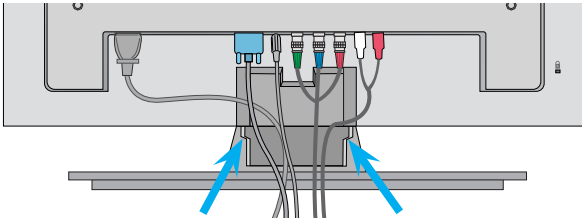

2. Fit the cable guide to the back to help manage the cables.

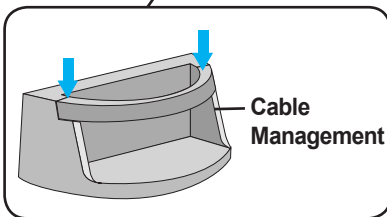
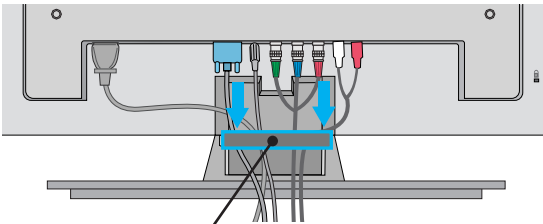

Removing the cable guide.

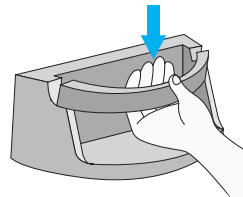

Hold the Cable management with both hands and pull it downward.

Note



- Do not use the cable management as a handle for the Monitor.

Connecting to External Devices

● Video Input

- 1 Connect the video cable as shown in the below figure and then connect the power cord. (See page 12).

When connecting with a BNC cable.

- Connect the input terminal with a proper color match.

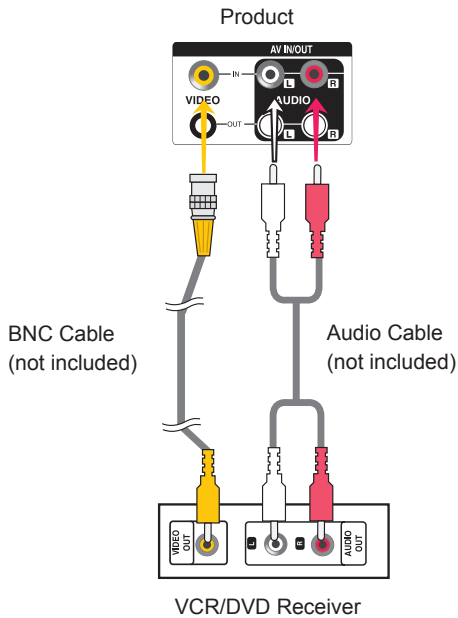

- 2 Select an input signal.
Press the **INPUT** button on the remote control to select the input signal.

INPUT → < > → **OK**

Or, press the **INPUT** button on the back of the product.

INPUT → ◀ ▶ → **AUTO/SET**

When connecting with an BNC cable.

- Select **AV**.



Connecting to External Devices

● Component Input (480i/480p/576i/576p/720p/1080i/1080p)

- 1080p is Only on M4716C model.

1 Connect the video/audio cable as shown in the below figure and then, connect the power cord (See page 12).

- Connect the input terminal with a proper color match.

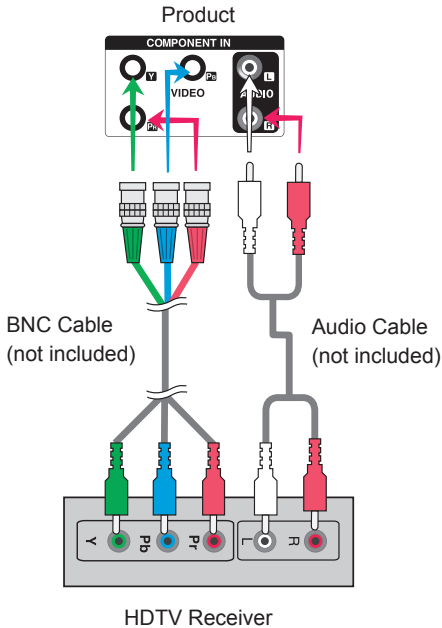

Note

- Some devices may require HDCP in order to display HD signals.
- Component doesn't support HDCP.

2 Select an input signal. Press the **INPUT** button on the remote control to select the input signal.

INPUT → < > → **OK**

Or, press the **INPUT** button on the back of the product.

INPUT → ◀ ▶ → **AUTO/SET**

- Select **Component**.



Connecting to External Devices

HDMI Input (480p/576p/720p/1080i/1080p)

HDMI Supports High Definition input and HDCP (High-bandwidth Digital Content Protection). Some devices require HDCP in order to display HD signals.

- 1 Connect the video/audio cable as shown in the below figure and then connect the power cord (See page 12).

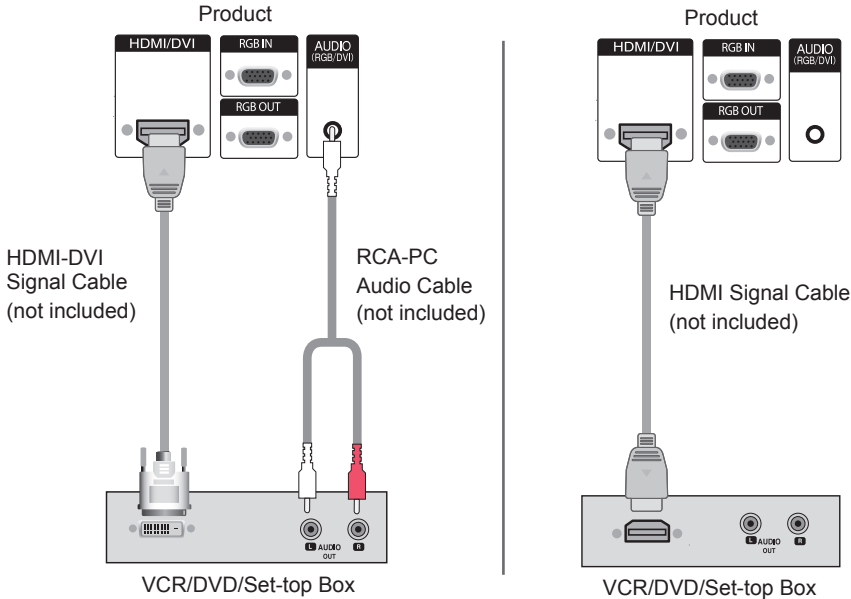

Note : Dolby Digital is not supported.

- 2 Select an input signal.
Press the **INPUT** button on the remote control to select the input signal.

INPUT → < > → **OK**

Or, press the **INPUT** button on the back of the product.

INPUT → ◀ ▶ → **AUTO/SET**

When connecting with a HDMI-DVI signal input cable.
When connecting with a HDMI signal input cable.

- Select **HDMI/DVI**

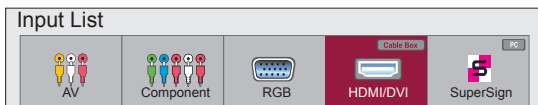

User Menus

● Screen Adjustment options

< M3204C >

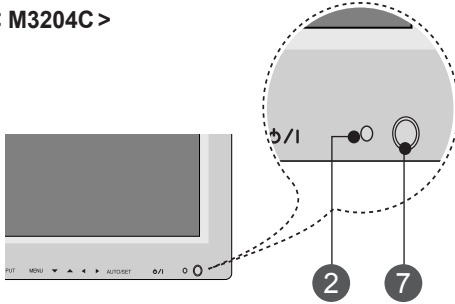

< M4716C >

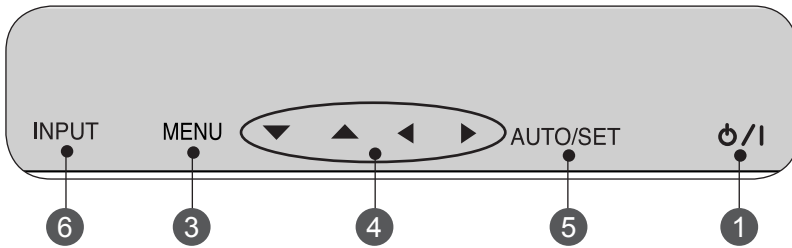
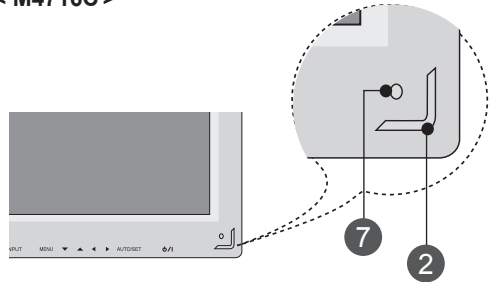

- 1 On/Off Button** Press this button to turn on the power. Press this button again to turn it off.

- 2 Power Indicator** This Indicator lights up green when the display operates normally(on mode). If the display is in sleep (Energy Saving) mode, this indicator color changes to amber.

- 3 MENU Button** Use this button to show/hide the OSD (On Screen Display) menu screen.

- 4 OSD Select / Adjust Button** Use this button to select an icon or adjust the setting in the OSD screen.

 - ▲ ▼ Adjust the up and down.
 - ◀ ▶ Adjust the volume.



User Menus

5 Screen Adjustment options

5 AUTO/SET Button

< M3204C >

[For PC Analog signal]

Auto in progress
For optimal display change
resolution to 1360 x 768

[When XGA Mode is active and
1360 x 768 is selected]

Auto in progress

< M4716C >

[For PC Analog signal]

Auto in progress
For optimal display change
resolution to 1920 x 1080

[When XGA Mode is active and
1920 x 1080 is selected]

Auto in progress

6 INPUT Button

INPUT → ◀ ▶ → AUTO/SET

- Toggles between inputs

AV	Composite Video
Component	HDTV, DVD
RGB	15-pin D-Sub analog signal
HDMI/DVI	Digital signal
SuperSign	SuperSign

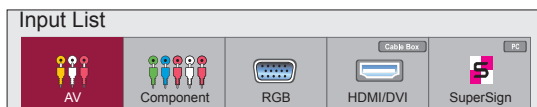







7 IR Receiver

This is where the unit receives signals from the remote control.

User Menus

OSD Menu

Icon	Function Description
 Picture	Adjusts screen brightness, contrast and color that you prefer.
 Audio	Adjusts the audio options.
 Time	Adjusts the timer options.
 Option	Adjusts the screen status according to the circumstances.
 Tile	Adjusts the tile options.
 USB	Adjusts the USB options.

Note



OSD(On Screen Display)

- The OSD function enables you to adjust the screen status conveniently since it provides graphical presentation.

User Menus

● How to adjust the OSD (On Screen Display) screen

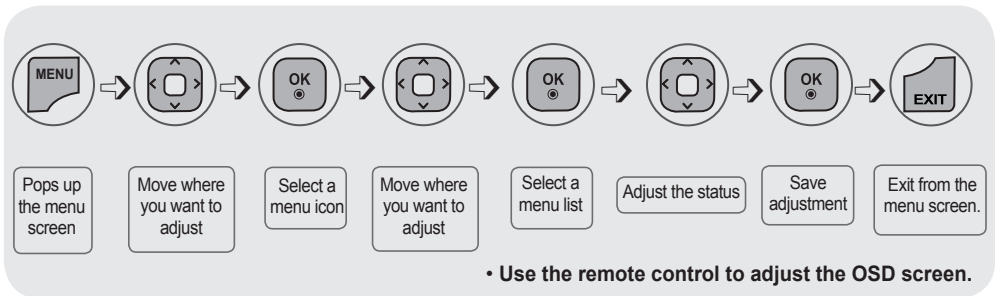

1 Press the **MENU** Button, then the main menu of the OSD appears.

2 To access a control, use the $\wedge \vee$ Buttons.

3 When the icon you want becomes highlighted, press the **OK** Button.

4 To access a control, use the $\wedge \vee$ Buttons.

5 When the list you want becomes highlighted, press the **OK** Button.

6 Use the $\wedge \vee < >$ Buttons to adjust the item to the desired level.

7 Accept the changes by pressing the **OK** Button.

8 Exit the OSD by pressing the **EXIT** Button.

● How to adjust the screen automatically

Press the **AUTO/SET** button (**AUTO** button on a remote Control) in the PC analog signal. Then optimal screen settings will be selected that fit into the current mode. If adjustment is not satisfactory, you can adjust the screen manually.

< M3204C >

[When XGA mode is active and 1360 x 768 is selected.]

Auto in progress

< M4716C >

[When XGA mode is active and 1920 x 1080 is selected.]

Auto in progress

User Menus

Adjusting Screen Color

Aspect Ratio

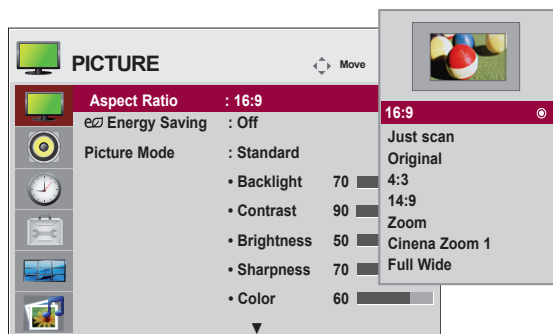

To select the image size of the screen.

16:9 : Widescreen mode.

Just Scan : Allows you to enjoy the transmitted data fully without any images cut off.

(*This menu is activated only in 720p,1080p,1080i (HDMI/DVI-DTV, Component mode)

Original : The aspect ratio is not adjusted from the original. It is set by the program being watched.

4:3 : This picture format is 4:3 aspect ratio.

1:1 : The aspect ratio is not adjusted from the original. Used in PC mode.

(Only HDMI/ DVI PC, RGB PC)

14:9 : 14:9 programs are viewed normally in 14:9 with black bars added to the top and bottom.

4:3 programs are magnified on the top/bottom and left/right sides.

Zoom : 4:3 programs are magnified until they fill the 16:9 screen. The top and bottom will be cut off.

Cinena Zoom 1 : Choose Cinema Zoom when you wish the picture to be altered, both horizontally extended and vertically cropped. The picture adopting a compromise between alteration and screen coverage.

Full Wide : When TV receives the wide screen signal, it will lead you to adjust the picture horizontally or vertically, in a linear proportion, to fill the entire screen fully.

MODE	ARC					
	AV	Component	RGB PC	HDMI / DVI DTV PC		SuperSign
16 : 9	●	●	●	●	●	●
Just Scan	×	●	×	●	×	×
Original	●	×	×	×	×	×
4 : 3	●	●	●	●	●	●
1 : 1	×	×	●	×	●	●
14 : 9	●	●	×	●	×	×
Zoom	●	●	×	●	×	×
Cinena Zoom 1	●	●	×	●	×	×
Full Wide	●	×	×	×	×	×

User Menus

Adjusting Screen Color

Energy Saving

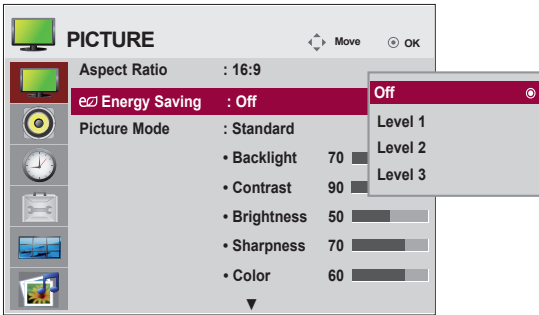

This screen brightness adjusting menu helps you save energy.

Level : Total 4 screen brightness levels are provided.

- **Off:** 100% light
- **Level 1:** 80% light
- **Level 2:** 60% light
- **Level 3:** 40% light

Note



- If the 'Picture Mode' is set to 'Cinema', the 'Energy saving' mode is disabled.

User Menus

Adjusting Screen Color

Picture Mode

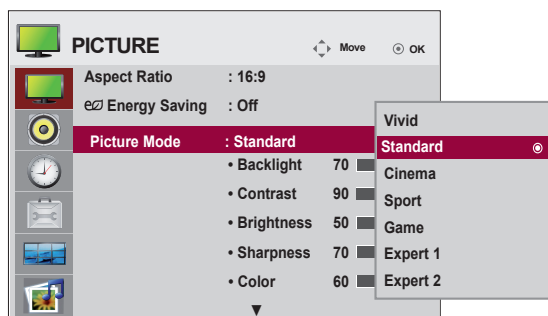

Toggles between screen presets.

Standard : The most general and natural screen display status.

Vivid : Select this option to display with a sharp image.

Cinema : Select this option to lower brightness by one level.

Sport : Select this option to display with a soft image.

Game : To enjoy dynamic image when playing a game.

Expert1,2 : Select this option to use the user-defined settings.

Note



- If the 'Picture Mode' setting in the Picture menu is set to Vivid, Standard, Cinema, Sport or Game the subsequent menus will be automatically set.

User Menus

Adjusting Screen Color

Picture Mode

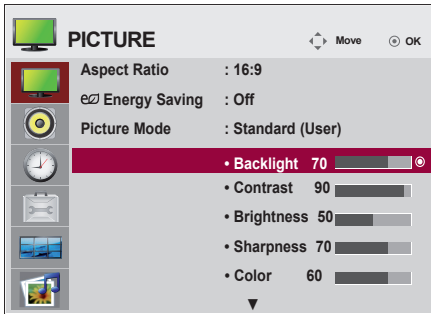

Backlight : To control the brightness of the screen,adjust the brightness of LCD panel.

Contrast : Adjust the difference between the light and dark levels in the picture.

Brightness : To adjust the brightness of the screen.

Sharpness : To adjust the clearness of the screen.

(This function can be used only under AV, Component and HDMI/DVI(DTV).)

Color : To adjust the color to desired level.

(This function can be used only under AV, Component and HDMI/DVI(DTV).)

Tint : To adjust the tint to desired level.

(This function can be used only under AV, Component and HDMI/DVI(DTV).)

User Menus

Adjusting Screen Color

Advanced Control

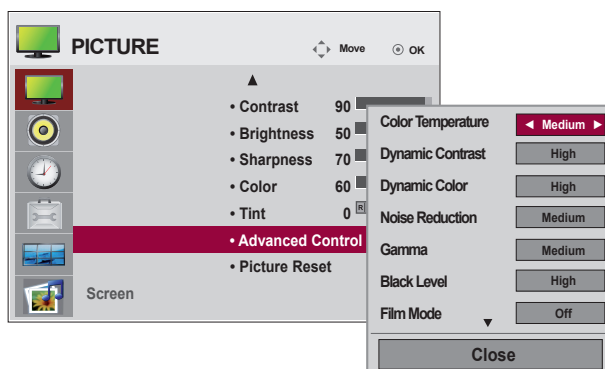

Color Temperature : Color Settings

Cool : Slightly purplish white.

Medium : Slightly bluish white.

Warm : Slightly reddish white.

Dynamic Contrast : Optimizes the contrast automatically according to the brightness of the reflection.
(This function can be used only under AV, Component and HDMI/DVI(DTV).)

Dynamic Color : Adjusts the Color of the reflection automatically to reproduce natural colours as close as possible.
(This function can be used only under AV, Component and HDMI/DVI(DTV).)

Noise Reduction : Removing the noise up to the point where it does not damage the original picture.
(This function can be used only under AV, Component and HDMI/DVI(DTV).)

Gamma : Set your own gamma value.

On the monitor, high gamma values display whitish images and low gamma values display high contrast images.

Black Level : (Function works in the following mode - AV, Component, HDMI-DTV) adjusts the contrast and the brightness of the screen using the black level of the screen.

Low : The reflection of the screen gets darker.

High : The reflection of the screen gets brighter.

Film Mode : (Function works in the following mode - AV, Component 480i/576i/1080i, HDMI/DTV 480i/576i/1080i) When you watch a movie, this function adjusts the set to the best picture appearance.

White Balance : This is the function to adjust the overall colour of the screen to the feeling you want. (Function works in the following mode - Expert 1, Expert 2 Picture mode)

Color Management System : As the tool used by the experts to make adjustments by using the test patterns, this does not affect other colours but can be used to selectively adjust the 6 colour areas (Red/Green/Blue/Cyan/Magenta/Yellow). Colour difference may not be distinctive even when you make the adjustments for the general video.(Function works in the following mode - Expert 1, Expert 2 Picture mode)

User Menus

Adjusting Screen Color

Picture Reset

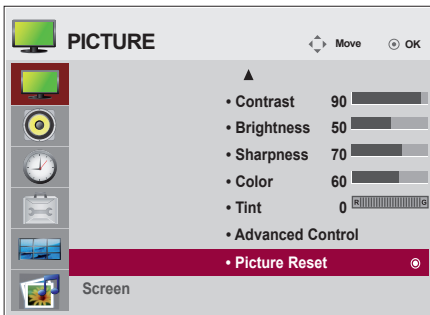

Return Picture Mode to the default factory settings.

Screen

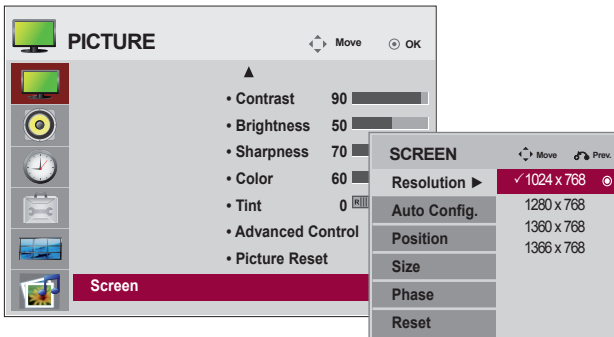

Adjust the screen video.

Resolution : To view a normal picture, match the resolution of RGB mode and selection of PC mode. This function works in the following mode: RGB[PC] mode.

Auto Config. (RGB PC input only) : This button is for the automatic adjustment of the screen position, clock and phase. This function is available for analog signals only.

Position : Moving the screen position.

Size : Adjust the size of the screen.

Phase : To adjust the focus of the display. This item allows you to remove any horizontal noise and clear or sharpen the image of characters. This function is available for analog signals only.

Reset : Return Manual config. to the default factory settings.

User Menus

Adjusting the audio function

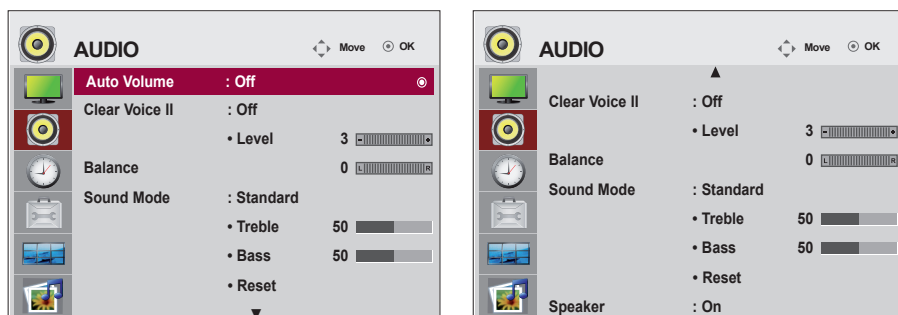

Auto Volume

To adjust uneven sound volumes across all channels or signals automatically to the most appropriate level. To use this feature, select On.

Clear Voice II

By differentiating the human sound range from others, it helps users listen to human voices better.

Balance

Use this function to balance sound from the left and right speakers.

Sound Mode

The best sound tone quality will be selected automatically depending on the video type that you're currently watching.

Standard : The most commanding and natural audio.

Music : Select this option to enjoy the original sound when listening to the music.

Cinema : Select this option to enjoy sublime sound.

Sport : Select this option to watch sports broadcasting.

Game : To enjoy dynamic sound when playing a game.

Speaker

You can adjust internal speaker status.

If you want to use your external hi-fi stereo system, turn off the internal speakers of the set.

User Menus

Adjusting the timer function

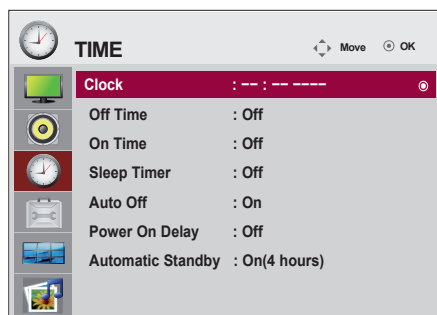

Clock

If the current time is incorrect, reset the clock manually.

- 1) Press the **MENU** button and then use $\wedge \vee < >$ button to select the Time menu, input OK button to enter.
- 2) Press the $>$ button and then use $\wedge \vee$ button to select clock menu.
- 3) Press the $>$ button and then use $< >$ button to select date.
- 4) Press the $\wedge \vee$ button and then use $< >$ button to set the hour(00h to 23h).
- 5) Press the $\wedge \vee$ button and then use $< >$ button to set the minutes(00 min to 59 min).

On/Off time

The off time automatically switches the set to standby at the pre-set time.

- 1) Press the **MENU** button and then use $\wedge \vee < >$ button to select the Time menu, input OK button to enter.
- 2) Press the $>$ button and then use $\wedge \vee$ button to select On/Off Timer.
- 3) Press the $>$ button and then use $< >$ button to select date
- 4) Press the $\wedge \vee$ button and then use $< >$ button to set the hour(00h to 23h).
- 5) Press the $\wedge \vee$ button and then use $< >$ button to set the minutes(00 min to 59 min).
- 6) Press the $\wedge \vee$ button ,According to the personal needs, choose to add button.

Sleep timer

The power is automatically turned off when the time set by a user is passed.

- 1) Press the **MENU** button and then use $\wedge \vee < >$ button to select the Time menu, input OK button to enter
- 2) Press the $>$ button and then use $\wedge \vee$ button to select Sleep timer menu.
- 3) Press the $\wedge \vee$ button and then use $< >$ button to select the minutes(Off to 240 min).

Auto off

If Auto off is active and there is no input signal, the set switches to off mode automatically after 10 minutes.

- 1) Press the **MENU** button and then use $\wedge \vee < >$ button to select the Timer menu, input OK button to enter.
- 2) Press the $>$ button and then use $\wedge \vee$ button to select the Auto off menu.
- 3) Press the $>$ button and then use $\wedge \vee$ button to select On or Off.

Power on delay

When connecting multiple monitors and turning the power on, the monitors are turned on individually to prevent overload.

Automatic Standby

If you do not use the monitor for more than 4 hours, it will be in standby mode automatically.

Note



- In the event of power interruption (disconnection or power failure), the clock must be reset.
- Once the on or off time is set, these functions operate daily at the preset time.
- The scheduled power-off function works properly only when the device time is set correctly. When the scheduled power-on and power-off times are the same, the power-off time has priority over the power-on time if the set is turned on, and vice versa if the set is turned off.
- When On time is operated, input screen is turned on as it was turned off.
- The **Automatic Standby** function may not be available depending on the country.

User Menus



Selecting the options

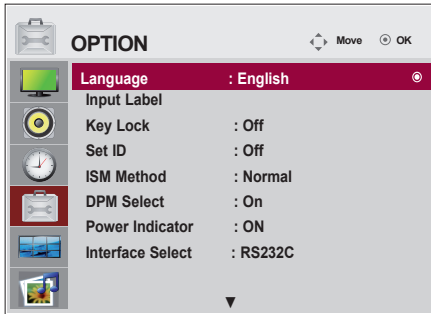

Language

To choose the language in which the control names are displayed.

Input Label

Selects a label for each input source. For example, when connecting to PC in RGB mode, * Select "PC" for the connecting device field. Otherwise, the screen may not display properly.

Key Lock

Use the \wedge \vee buttons to select **On** or **Off**. The monitor can be set up so that it can only be used with the remote control. This feature can prevent unauthorized viewing.

In order to lock the OSD screen adjustment, set the **Key Lock** tab to the 'On' position.

In order to unlock it, do the following :

Push the **MENU** button on the remote control and set **Key Lock** to the 'Off' position.

Set ID

You can assign a unique **Set ID** NO (name assignment) to each product when several products are connected for display. Specify the number (1 to 99) using the < > button and exit. Use the assigned **Set ID** to individually control each product using the Product Control Program.

ISM Method

Leaving a fixed image on the screen for a long time may cause damage to the screen and cause image burn-in. To use the product for a long period of time, use a screen saver on the PC or utilize the residual image prevention function on the product, and when the product is not used, turn off the power. Burn-in and related problems are not covered by the warranty on this product.

Normal : Leave on normal if you don't foresee image burn in being a problem.

Orbiter : May help prevent ghost images. However, it is best not to allow any fixed image to remain on the screen. To avoid a permanent image on the screen, the screen will move every 2 minutes.

Inversion : This function inverts the panel color of the screen. The panel color is automatically inverted every 30 minutes.

White wash : White wash fills the screen with solid white. This helps removes permanent images burned into the screen. A permanent image may be impossible to clear entirely with white wash.

User Menus



Selecting the options

< M3204C >

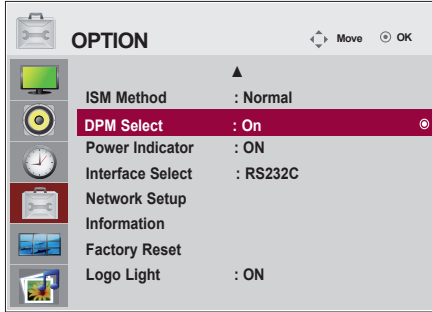

< M4716C >

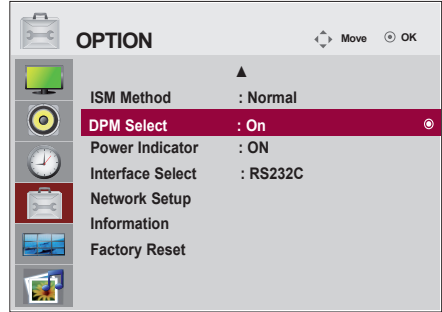

DPM Select

A user can choose to turn the power saving mode on / off.

Power Indicator

Use this function to set the power indicator on the front side of the product to On or Off. If you set Off, it will go Off. If you set On at any time, the power indicator will automatically be turned on.

Interface Select

Sets up network connections.

- Network : LAN - Enables communication via Ethernet.
- RS-232C : Enables communication via Serial.

Network Setup

- DHCP : Allocates and sets up IP automatically.
- Manual : Sets up IP address, Gateway, Subnet Mask, Primary DNS and Secondary DNS.
The setup process is complete when you select Execute, and **"IP Setup Completed"** is displayed at the bottom of the screen. While **"Wait for IP Setup"** is displayed, you cannot use the local keys and remote control. **"Wait for IP Setup"** is displayed for up to 40 seconds.

*If Interface select is set to RS232C, DHCP and Manual are disabled.

Information

You can find information about Serial No, F/W version, IP Address and MAC Address.

Factory Reset

Select this option to return to the default factory settings.

Logo Light (Only M3204C)

Use this function to reset the Logo Display Lamp On the front side of the product to On or Off. If you set On, the lamp will automatically be turned on.

* The function may be disabled depending on the product. See the table below.

Product color	Logo Light
Black	x
Silver	o
White	o

User Menus



Adjusts the tile options.

Tile Mode

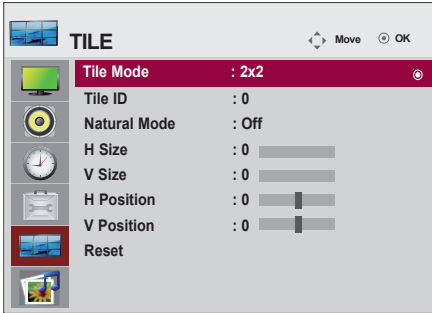

- Must be displayed with various other products.
- Must be in a function that can be connected to RS-232C or RGB Out.
- It is used to enlarge the screen and also used with several products to view screen.

Tile mode and choose Tile alignment and set the ID of the current product to set location. Only after pressing the SET button the adjustments made to the settings will be saved.

- Tile mode : column x row (c = 1, 2, 3, 4, 5 r = 1, 2, 3, 4, 5)
- 5 x 5 available.
- Configuration of an integration screen is also available as well as configuration of One by one Display.



- Tile mode (product 1 ~ 4) : c(2) x r(2)

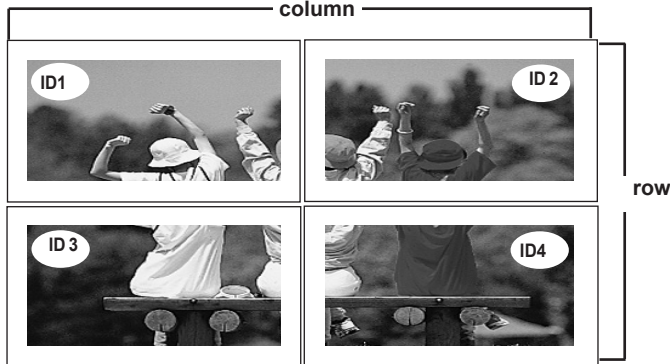

User Menus



Adjusts the tile options.

- Tile mode (product 1 ~ 9) : c(3) x r(3)

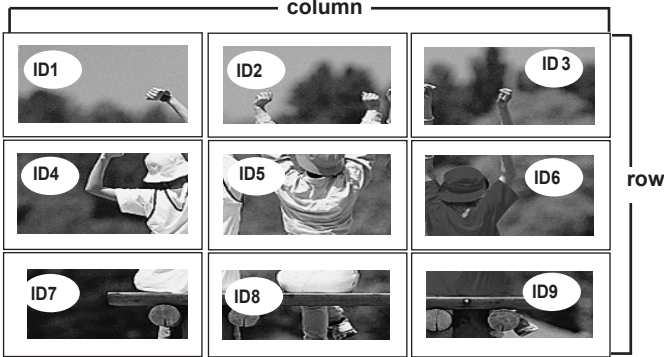

- Tile mode (product 1 ~ 2) : c(2) x r(1)

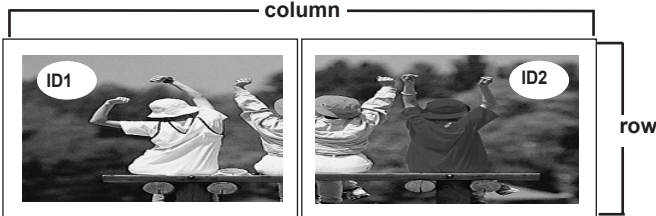

- Tile mode (product 1 ~16) : c(4) x r(4)

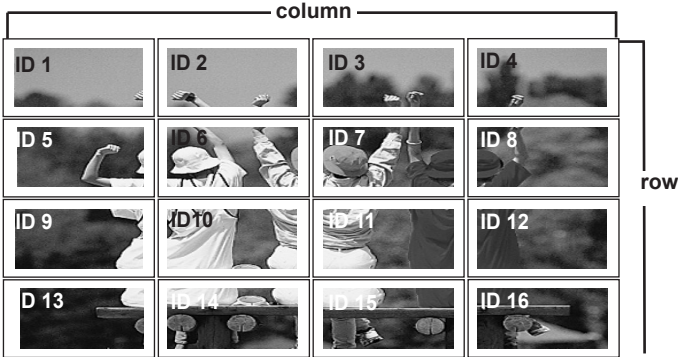

Tile ID : Select the location of the Tile by setting an ID.

Natural : The image is omitted by the distance between the screens to be naturally shown.

H-Size : Adjust the horizontal size of the screen taking into account the size of the bezel.

V-Size : Adjust the vertical size of the screen taking into account the size of the bezel.

H-Position : Moving the screen position horizontally.

V-Position : Moving the screen position vertically.

Reset : Function to initialize and release Tile.

All Tile setting are released when selecting Tile recall and the screen returns to Full screen.

User Menus



Adjusts the USB options.

When connecting the USB device

When you connect a USB device, this pop up menu is displayed, automatically. "POP UP MENU" will not be displayed while the OSD including Menu, EPG or Schedule list is activated.

When the Pop Up menu appears, you can select Music List, Photo List or Movie List in the MY MEDIA menu.

In USB device, you can not add a new folder or delete the existing folder.

1. Connect the USB device to the **USB** jack on the product.

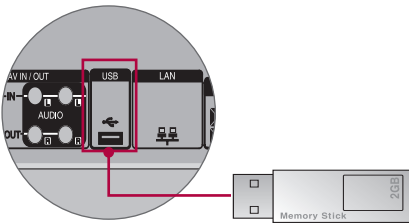

2. Select **PHOTO LIST**, **MUSIC LIST** or **MOVIE LIST**.



User Menu



Adjusts the USB options.

Precautions when using the USB device

- Only a USB storage device is recognizable.
- If the USB storage device is connected through a USB hub, the device is not recognizable.
- A USB storage device using an automatic recognition programme may not be recognized.
- A USB storage device which uses its own driver may not be recognized.
- The recognition speed of a USB storage device may depend on each device.
- Please do not turn off the TV or unplug the USB device when the connected USB storage device is working. When such device is suddenly separated or unplugged, the stored files or the USB storage device may be damaged.
- Please do not connect the USB storage device which was artificially maneuvered on the PC. The device may cause the product to malfunction or fail to be played. Never forget to use only a USB storage device which has normal music files or image files.
- Please use only a USB storage device which was formatted as a FAT16, FAT32, NTFS file system provided with the Windows operating system. In case of a storage device formatted as a different utility programme which is not supported by Windows, it may not be recognized. Data in a USB storage device cannot be deleted in the NTFS file system.
- Please connect power to a USB storage device which requires an external power supply. If not, the device may not be recognized.
- Please connect a USB storage device with cable is offered by USB maker. If connected with cable is not offered by USB maker or an excessively long cable, the device may not be recognized.
- Some USB storage devices may not be supported or operated smoothly.
- Maximum of 999 files and folders can be recognized.
- Data in a USB storage device cannot be aligned. Up to 128 English characters can be recognized as a file name.
- Please back up the important file because a data of USB device may be damaged. Data management is consumer's responsibility and in consequence the manufactures does not cover the product bearing data damage.
- If the USB is connected in Standby Mode, specific hard disk will automatically be loaded when the TV is turned on.
- The recommended capacity is 1TB or less for a USB external hard disk and 32GB or less for USB memory.
- Any device with more than the recommended capacity may not work properly.
- If a USB external hard disk with a "Power Saving" function does not work, turn the hard disk off and on again to make it work properly.
- Names and subtitles of some language files may not display properly.(Korean, Chinese, Japanese)
- When using Korean, Japanese or Chinese subtitles or file names, it is recommended to set the language to the corresponding one.

User Menus



Adjusts the USB options.

Photo List

You can view photo files on USB storage device.

The On Screen Display may be different from your product. Images are an example to assist with the product operation.

PHOTO(*.JPEG) supporting file

Baseline: 15360 x 8640

Progressive : 1024 x 768

- You can play JPEG files only.
- Non-supported files are displayed in the form of bitmap.

Screen Components

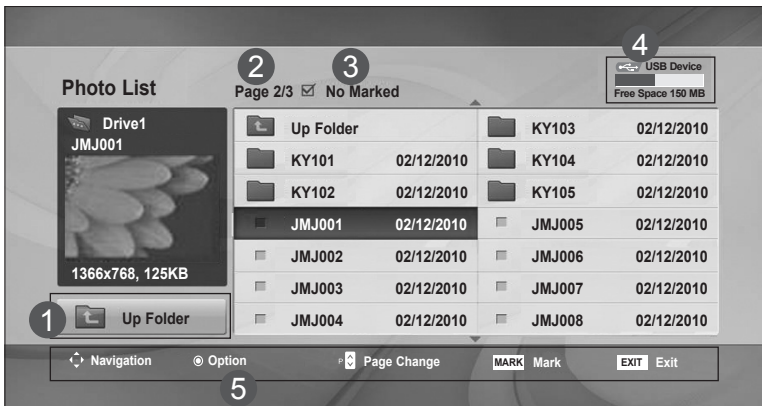

- 1 Moves to upper level folder
- 2 Current page / Total pages
- 3 Total number of marked photos
- 4 Usable USB memory
- 5 Corresponding buttons on the remote control

User Menus



Adjusts the USB options.

Photo Selection and PopUp Menu

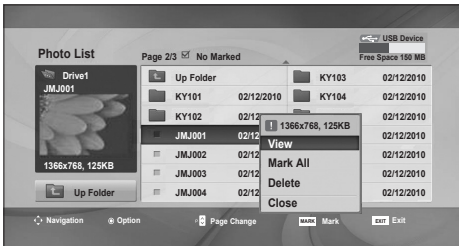
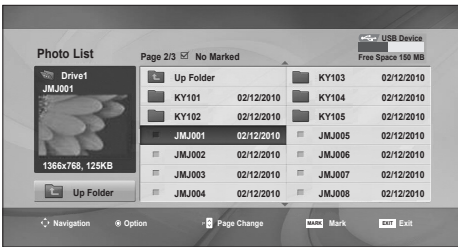

- View** : Display the selected item.
- Mark All** : Mark all photos on the screen.
- Unmark All** : Deselect all marked photos.
- Delete** : Delete the selected photo item.
- Close** : Close the pop-up menu.

User Menu



Adjusts the USB options.

How to view photo

Detailed operations are available on full-sized photo view screen.

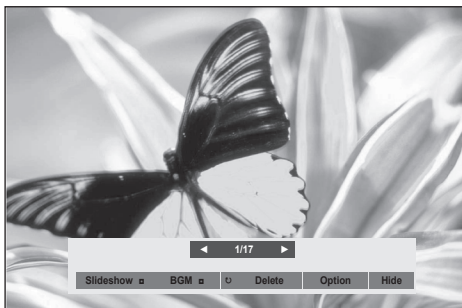

The aspect ratio of a photo may change the size of the photo displayed on the screen in full size. Press the **EXIT** button to move to the previous menu screen.

▶ Slideshow

When no picture is selected, all photos in the current folder are displayed during slide show. If some photos are selected, those photos are displayed in a slide show.

- Set the time interval of the slide show in **Option**.

▶ BGM (Background Music)

Listen to music while viewing photos in full size.

- Set the Music Folder for **BGM** in Options before using this function.

▶ (Rotate)

- Rotate photos. Rotates the photo 90°, 180°, 270°, 360° clockwise.

▶ Delete

Delete photos.

▶ Option

Set values for **Slide Speed** and **Music Folder** for **BGM**.

- Use $\wedge \vee < >$ button and **OK** button to set values. Press **OK** to save the settings.
- You cannot change **Music Folder** while **BGM** is **playing**.

▶ Hide

Hide the menu on the full-sized screen. To see the menu again on the full-sized screen, press **OK** button to display.

User Menus



Adjusts the USB options.

Music List

You can play music files on USB storage device.

Purchased music files(*.MP3) may contain copyright restrictions. Playback of these files may not be supported by this model. Music file on your USB device can be played by this unit.

The On Screen Display may be different from your TV. Images are an example to assist with the TV operation.

MUSIC (*.MP3) supporting file

Bit rate 32 to 320kbps

• Sampling rate MPEG1 layer 3: 32 kHz, 44.1 kHz, 48 kHz.

Screen Components

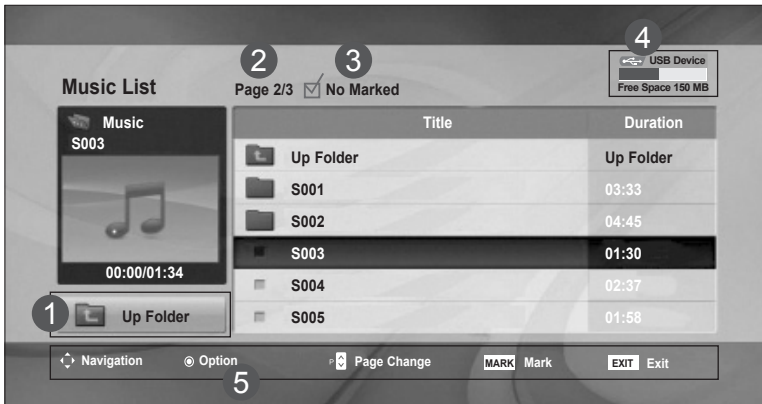

- 1 Moves to upper level folder
- 2 Current page / Total pages
- 3 Total number of marked music title
- 4 Usable USB memory
- 5 Corresponding buttons on the remote control

User Menus



Adjusts the USB options.

Music Selection and PopUp Menu

As shown, up to 6 music titles are listed per page.

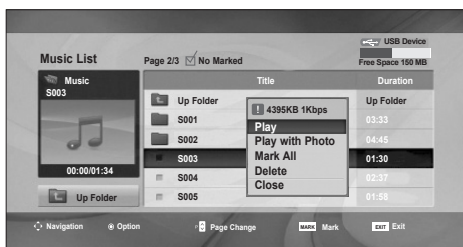
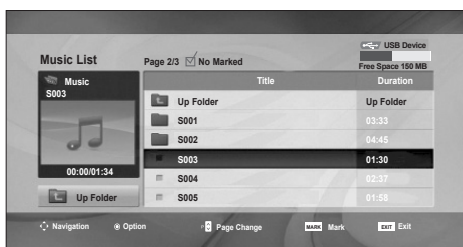

Play (During stop) : Play the selected music titles.

One playback of a piece of music finishes, the next selected one will be played. When there are no selected music titles to play, the next one in the current folder will be played. If you go to a different folder and press the OK button, the current music in playback will stop.

Play Marked: Play the selected music titles. Once a music finishes playing, the next selected one will be played automatically.

Stop Play (During playback): Stop the playing music titles.

Play with Photo: Start playing the selected music titles and then move to the Photo List.

Mark All : Mark all music titles in the folder.

Unmark All : Deselect all marked music titles.

Delete : Delete the selected music titles.

Close : Close the pop-up menu.

User Menu



Adjusts the USB options.

If you don't press any button for a while during the playing, the play information box (as shown in the below) will float as a screen saver.

The 'Screen Saver'?

Screen saver is to prevent screen pixel damage due to an fixed image remaining on the screen for a extended period of time.

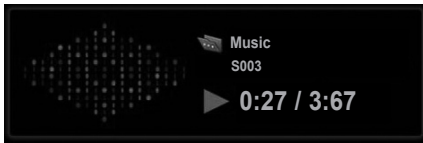

Note



- A damaged or corrupted music does not play but displays 00:00 in playtime.
- A music downloaded from a paid service with copyright protection does not start but displays inappropriate information in playtime.
- If you press OK, **■** buttons, screen saver is stopped.
- The PLAY(▶), Pause(⏸), **■**, ▶▶, ◀◀ buttons on the remote control are also available in this mode.
- You can use the ▶▶ button to select the next music and the ◀◀ button to select the previous music.

User Menus



Adjusts the USB options.

Movie List

The movie list is activated once USB is detected. It is used when playing movie files on TV.

Displays the movies in the USB folder and supports Play.

Allows playback of all movies in the folder and user desired files.

Video editing is not supported but files can be deleted.

It is a movie list that displays folder information and DivX file.

Supports up to four drives.

MOVIE(*.avi/*DivX) supporting file

Video format : MPEG1, MPEG2, MPEG4(Doesn't support Microsoft MPEG 4-V2, V3), DivX 3.xx, DivX 4.xx, DivX 5.xx, DivX VOD(DRM), XviD, DivX 6.xx(Playback)

Audio format : Mpeg, Mp3, PCM, Dolby Digital

Sampling frequency : within 32k to 48 khz

Bit rate : 32k to 320 kbps

Subtitle format : *.smi/ *.srt/ *.sub(MicroDVD, SubViewer 2.0)/ *.ass/ *.ssa/*.txt(DVD Subtitle System)

- DivX may not be played depending on its types or recording methods.
- If the video and audio structure of recorded file is not interleaved, either video or audio is outputted.
- Maximum FPS (Frame Per Second) can be reached only at SD level. FPS is 25 FPS (720*576) or 30 FPS (720*480) depending on Resolution.
- Max bitrate of playable DivX is 4Mbps.
- Files more than 25 FPS or 30 FPS or higher may not be played properly.
- A DivX movie file and its subtitle file must be located in the same folder.
- A video file name and its subtitle file name must be identical for it to be displayed.
- Playing a video via a USB connection that doesn't support high speed may not work properly.
- USB storage devices below USB 2.0 are supported as well. But they may not work properly in the movie list.
- Files encoded with GMC(Global Motion Compensation) may not be played.

Extension name	Video Decoder	Audio Codec	Max Resolution
mpg, mpeg, vob, dat	MPEG1, MPEG2	AC3,MPEG,MP3,PCM	720x576@25p 720x480@30p
Avi, DivX, m4v	MPEG4-SP, MPEG4-ASP, DivX3.xx, DivX4.xx, DivX5.xx DivX6.xx(Playback), XviD	AC3,MPEG,MP3,PCM	

User Menus



Adjusts the USB options.

Screen Components

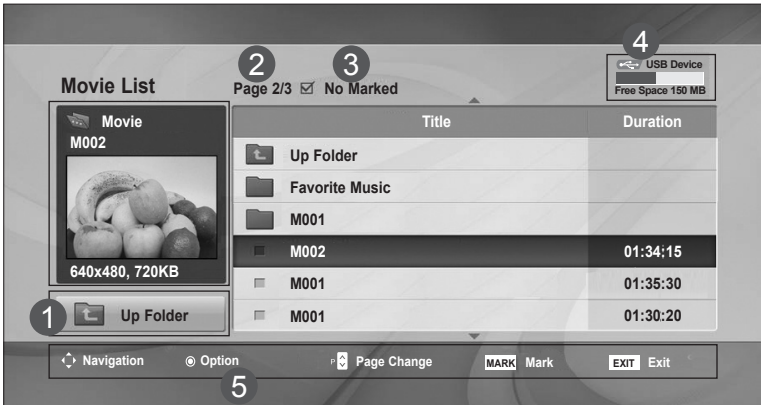

- 1 Moves to upper level folder
- 2 Current page / Total pages
- 3 Total number of marked movie title
- 4 Usable USB memory
- 5 Corresponding buttons on the remote control

Note



- Use the left/right (< / >) keys to move to a specific frame forward or backward while playing a movie. (The left/right (< / >) keys may not work properly for some files while playing a movie.)

User Menus



Adjusts the USB options.

Movie Selection and PopUp Menu

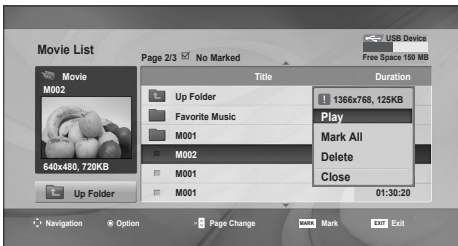
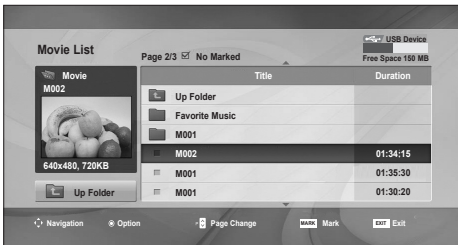

Play: Plays the selected movie. DivXplay is executed while the screen changes.

Mark All: Marks all movies in the folder.

Unmark All : Deselect all marked movies.

Delete: Deletes the selected movie.

Close: Closes the pop-up menu.

Using the remote control

	When playing, repeatedly, press REW (◀◀) to speed up ◀◀(x2) -> ◀◀◀◀(x4) -> ◀◀◀◀◀◀(x8) -> ◀◀◀◀◀◀◀◀(x16) -> ◀◀◀◀◀◀◀◀◀(x32). Repeatedly, press FF (▶▶) to speed up ▶▶(x2)-> ▶▶▶▶(x4) -> ▶▶▶▶▶▶(x8) -> ▶▶▶▶▶▶▶▶(x16) -> ▶▶▶▶▶▶▶▶▶▶(x32). Pressing these buttons repeatedly increases the fast forward/reverse speed.
	During playback, press Pause () and the still screen is displayed.
	During playback, stops the screen.
	Press Play(▶) to return to normal playback.



Note

- In the case of files not supported, a message regarding non-supported file is displayed.

User Menus



Adjusts the USB options.

When you select the Set Video Play,

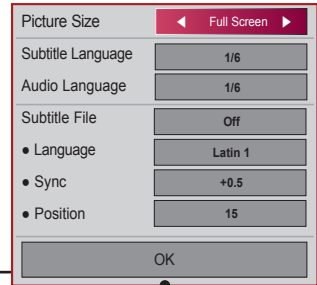

Picture Size : Sets to [Full Screen] or [Original Size].

Subtitle Language : Allows to select the language you want for the file with multiple subtitle tracks.

This option is not available if the file has only one subtitle track.

Audio Language : Allows to select the language you want for the file with multiple audio tracks.

This option is not available if the file has only one audio track.

Subtitle File : Sets to **On** or **Off**.

Language : Sets to one of Latin1, Latin2, Latin4, Latin5, Cyrillic, Greek, Hebrew, Chinese, Japanese and Korean.

Sync : Adjusts the subtitle delay from 0 and +5.0 in 0.5 second increments.

Position : Moves the subtitle position from 0 to 16.

* You can move the video back or forward by clicking < or > key.

User Menus



Adjusts the USB options.

DivX Registration Code

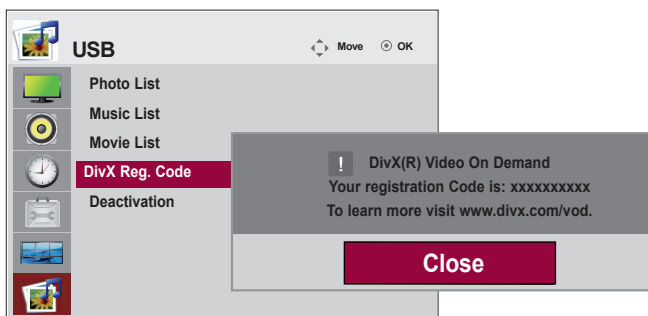

Confirm the DivX registration code number of the TV. Using the registration number, movies can be rented or purchased at www.divx.com/vod.

With a DivX registration code from other TV, playback of rented or purchased DivX file is not allowed. (Only DivX files matched with the registration code of the purchased TV are playable.)



ABOUT DivX VIDEO: DivX® is a digital video format created by DivX, Inc. This is an official DivX Certified device that plays DivX video. Visit www.divx.com for more information and software tools to convert your files into DivX video.

ABOUT DivX VIDEO-ON-DEMAND: This DivX Certified® device must be registered in order to play DivX Video-on-Demand (VOD) content. To generate the registration code, locate the DivX VOD section in the device setup menu. Go to vod.DivX.com with this code to complete the registration process and learn more about DivX VOD.

“DivX Certified to play DivX video, including premium content”

“Pat. 7,295,673; 7,460,668; 7,515,710; 7,519,274”

Note



- Supported movie file
Resolution : under 25 frames/sec(720x576 WxH pixels).
Frame rate : under 30 frames/sec(720x480)
- Video Codec : MPEG1, MPEG2, MPEG4(Doesn't support Microsoft MPEG4-V2, V3), DivX3.xx, DivX4.xx, DivX5.xx, , DivX VOD(DRM), XviD, DivX6.xx(Playback).
- When loading, some buttons may not work.

User Menus



Adjusts the USB options.

Deactivation

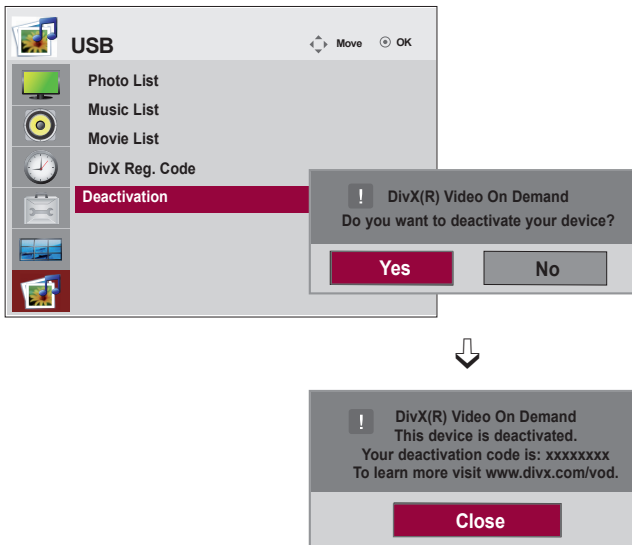

The purpose of deactivation is to allow deactivation of devices for users who have activated all the available devices through the web_server and are blocked from activating more devices. DivX VOD allowed the consumer to activate up to 6 devices under one account, but to replace or deactivate any of those devices, the consumer had to contact DivX Support and request deletion. Now with this added feature, consumers will be able to deactivate the device themselves and hence better manage their DivX VOD devices.

Troubleshooting

No image is displayed

- Is the power cord connected?
 - Is the power indicator light on?
 - <M3204C>
 - Power is on, power indicator is Green but the screen appears extremely dark.
 - <M4716C>
 - Power is on, power indicator is Blue but the screen appears extremely dark.
 - Is the power indicator amber?
 - Does the 'Out of range' message appear?
 - Does the 'Check signal cable' message appear?
- See if the power cord is properly connected to the outlet.
 - See if the power switch is turned on.
 - May need service.
 - Adjust brightness and contrast again.
 - Backlight may need repair.
 - If the set is in power saving mode, move the mouse or press any key.
 - Turn both devices off and then back on.
 - The signal from the PC (video card) is out of the vertical or horizontal frequency range of the set. Adjust the frequency range by referring to the specifications in this manual.
 - * **Maximum Resolution**
 - RGB: 1600x1200 @ 60 Hz < M3204C >
 - 1920x1080 @ 60 Hz < M4716C >
 - HDMI/DVI: 1920x1080 @ 60 Hz
 - The signal cable between PC and set is not connected. Check the signal cable.
 - Press INPUT on the remote control to check the input signal.

'UnknownProduct' message appears when the product is connected.

- Did you install the driver?
- Install the product driver, which is provided with the product, or download it from the web site. (<http://www.lg.com>)
- See if the plug&play function is supported by referring to the video card user manual.

'Key Lock On' message appears.

- The 'Key Lock On' message appears when pressing the Menu button.
- The control locking function prevents unintentional OSD setting change due to careless usage. To unlock the controls, simultaneously press the Menu button and ► button for several seconds. (You cannot set this function using the remote control buttons. You can set this function in the product only.)

Troubleshooting

The screen image looks abnormal.

- Is the screen position wrong?
 - D-Sub analog signal - Press the "AUTO" button in the remote control to automatically select the optimal screen status that fits into the current mode. If adjustment is not satisfactory, use the Position OSD menu.
 - See if the video card resolution and frequency are supported by the product. If the frequency is out of range, set to the recommended resolution in the Control Panel "Display" Setting menu.
- Do thin lines appear on the background screen?
 - D-Sub analog signal - Press the "AUTO" button in the remote control to automatically select an optimal screen status that fits into the current mode. If adjustment is not satisfactory, use the Clock OSD menu.
- Horizontal noise appears or the characters look blurred.
 - D-Sub analog signal - Press the "AUTO" button in the remote control to automatically select an optimal screen status that fits into the current mode. If adjustment is not satisfactory, use the Phase OSD menu.
- The screen is displayed abnormally.
 - The proper input signal is not connected to the signal port. Connect the signal cable that matches with the source input signal.

After-image appears on the product.

- After-image appears when the product is turned off.
 - If you use a fixed image for a long time, the pixels may be damaged quickly. Use the screen-saver function.

Note



- **Vertical frequency:** To enable the user to watch the product display, screen image should be changed tens of times every second like a fluorescent lamp. The vertical frequency or refresh rate is the times of image display per second. The unit is Hz.
- **Horizontal frequency:** The horizontal interval is the time to display one vertical line. When 1 is divided by the horizontal interval, the number of horizontal lines displayed every second can be tabulated as the horizontal frequency. The unit is kHz.

Troubleshooting

The audio function does not work.

- **No sound?**
 - See if the audio cable is connected properly.
 - Adjust the volume.
 - See if the sound is set properly.
- **Sound is too dull.**
 - Select the appropriate equalize sound.
- **Sound is too low.**
 - Adjust the volume.

Screen color is abnormal.

- **Screen has poor color resolution (16 colors).**
 - Set the number of colors to more than 24 bits (true color)
Select Control Panel - Display - Settings - Color Table menu in Windows.
- **Screen color is unstable or mono-colored.**
 - Check the connection status of the signal cable. Or, re-insert the PC video card.
- **Do black spots appear on the screen?**
 - Several pixels (red, green, white or black color) may appear on the screen, which can be attributable to the unique characteristics of the LCD panel. It is not a malfunction of the LCD.

The operation does not work normally.

- **The power suddenly turned off.**
 - Is the sleep timer set?
 - Check the power control settings.
Power interrupted.
 - "CAUTION! FAN STOP!"
If the power is turned off after this message appears, it means that the fan is out of order. In this case, contact your local service center.

Specifications

< M3204C >

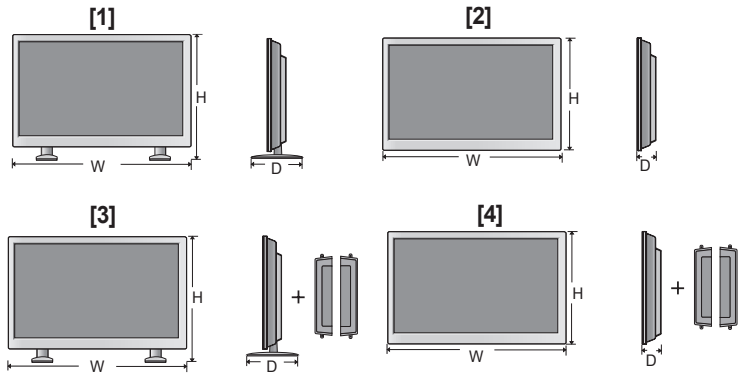
LCD Panel	80.0 cm (31.5 inch) TFT (Thin Film Transistor) LCD (Liquid Crystal Display) Panel Visible diagonal size: 80.0 cm 0.51075 mm				
Power	<table> <tr> <td>Rated Voltage</td> <td>AC 100-240 V~ 50 / 60 Hz 1.6 A</td> </tr> <tr> <td>Power Consumption</td> <td>On Mode : 100 W Typ. Sleep Mode : ≤ 1 W (RGB) / 2 W (HDMI/DVI) (If LAN OFF is selected) Off Mode : ≤ 0.5 W</td> </tr> </table>	Rated Voltage	AC 100-240 V~ 50 / 60 Hz 1.6 A	Power Consumption	On Mode : 100 W Typ. Sleep Mode : ≤ 1 W (RGB) / 2 W (HDMI/DVI) (If LAN OFF is selected) Off Mode : ≤ 0.5 W
Rated Voltage	AC 100-240 V~ 50 / 60 Hz 1.6 A				
Power Consumption	On Mode : 100 W Typ. Sleep Mode : ≤ 1 W (RGB) / 2 W (HDMI/DVI) (If LAN OFF is selected) Off Mode : ≤ 0.5 W				
Dimensions & Weight	 <p>Width x Height x Depth</p> <p>[1] 80.29 cm (31.61 inch) x 53.18 cm (20.93 inch) x 30.19 cm (11.88 inch) [2] 80.29 cm (31.61 inch) x 49.30 cm (19.41 inch) x 9.98 cm (3.93 inch) [3] 80.29 cm (31.61 inch) x 53.18 cm (20.93 inch) x 30.19 cm (11.88 inch) [4] 80.29 cm (31.61 inch) x 49.30 cm (19.41 inch) x 9.98 cm (3.93 inch)</p>				
Net	<table> <tr> <td>[1] 14.02 kg (30.90 lb)</td> <td>[2] 13.20 kg (29.10 lb)</td> </tr> <tr> <td>[3] 14.80 kg (32.62 lb)</td> <td>[4] 13.98 kg (30.82 lb)</td> </tr> </table>	[1] 14.02 kg (30.90 lb)	[2] 13.20 kg (29.10 lb)	[3] 14.80 kg (32.62 lb)	[4] 13.98 kg (30.82 lb)
[1] 14.02 kg (30.90 lb)	[2] 13.20 kg (29.10 lb)				
[3] 14.80 kg (32.62 lb)	[4] 13.98 kg (30.82 lb)				

Note



- The specifications shown above may be changed without prior notice for quality improvement.

Specifications

< M4716C >

LCD Panel	119.28 cm (46.96 inch) TFT (Thin Film Transistor) LCD (Liquid Crystal Display) Panel Visible diagonal size : 119.28 cm 0.5415 mm x 0.5415 mm x RGB (Pixel Pitch)					
Power	<table> <tr> <td>Rated Voltage</td> <td>AC 100-240 V~ 50 / 60 Hz 3.3 A</td> </tr> <tr> <td>Power Consumption</td> <td> On Mode : 240 W Typ. Sleep Mode : ≤ 1 W (RGB) / 2 W (HDMI/DVI) (If LAN OFF is selected) Off Mode : ≤ 0.5 W </td> </tr> </table>	Rated Voltage	AC 100-240 V~ 50 / 60 Hz 3.3 A	Power Consumption	On Mode : 240 W Typ. Sleep Mode : ≤ 1 W (RGB) / 2 W (HDMI/DVI) (If LAN OFF is selected) Off Mode : ≤ 0.5 W	
Rated Voltage	AC 100-240 V~ 50 / 60 Hz 3.3 A					
Power Consumption	On Mode : 240 W Typ. Sleep Mode : ≤ 1 W (RGB) / 2 W (HDMI/DVI) (If LAN OFF is selected) Off Mode : ≤ 0.5 W					
Dimensions & Weight	<div style="text-align: center;"> </div> <p>Width x Height x Depth</p> <p>[1] 111.70 cm (44.0 inch) x 66.10cm (26.0 inch) x 11.87 cm (4.7 inch) [2] 111.70 cm (44.0 inch) x 75.78cm (29.8 inch) x 30.26 cm (11.9 inch) [3] 111.70 cm (44.0 inch) x 66.10cm (26.0 inch) x 11.87 cm (4.7 inch) [4] 111.70 cm (44.0 inch) x 75.78cm (29.8 inch) x 30.26 cm (11.9 inch)</p> <p>Net</p> <table> <tr> <td>[1] 26.42 kg (58.2 lb)</td> <td>[2] 30.44 kg (67.1 lb)</td> </tr> <tr> <td>[3] 27.16 kg (59.9 lb)</td> <td>[4] 31.18 kg (68.7 lb)</td> </tr> </table>		[1] 26.42 kg (58.2 lb)	[2] 30.44 kg (67.1 lb)	[3] 27.16 kg (59.9 lb)	[4] 31.18 kg (68.7 lb)
[1] 26.42 kg (58.2 lb)	[2] 30.44 kg (67.1 lb)					
[3] 27.16 kg (59.9 lb)	[4] 31.18 kg (68.7 lb)					

Note



- The specifications shown above may be changed without prior notice for quality improvement.

Specifications

Video Signal	Max. Resolution	RGB: 1600x1200 @ 60 Hz < M3204C > 1920x1080 @ 60 Hz < M4716C > HDMI/DVI: 1920x1080 @ 60 Hz - It may not be supported depending on the OS or video card type.
	Recommended Resolution	RGB: WXGA 1360x768 @ 60 Hz < M3204C > WXGA 1920x1080 @ 60 Hz < M4716C > HDMI/DVI: WXGA 1360x768 @ 60 Hz < M3204C > WXGA 1920x1080 @ 60 Hz < M4716C > - It may not be supported depending on the OS or video card type.
	Horizontal Frequency	RGB: 30 kHz to 83 kHz HDMI/DVI: 30 kHz to 83 kHz
	Vertical Frequency	RGB: 56 Hz to 75 Hz HDMI/DVI: 56 Hz to 60 Hz
	Synchronization Type	Composite/Separate/Digital
Input Connector	15-pin D-Sub type, HDMI/DVI(digital) Composite Video, Component, RS-232C, LAN, USB	
Environmental Conditions	Operational Condition	Temperature: 0 °C to 40 °C , Humidity: 10 % to 80 %
	Storage Condition	Temperature: -20 °C to 60 °C , Humidity: 5 % to 95 %

Audio specification are applicable only for models that support speakers.

Audio	RMS Audio Output	10 W + 10 W (R + L)
	Input Sensitivity	0.7 Vrms
	Speaker Impedance	8 Ω

Note



- The specifications shown above may be changed without prior notice for quality improvement.

Specifications

● PC Mode - Preset Mode

Preset Mode		Horizontal Frequency (kHz)	Vertical Frequency (Hz)	Preset Mode		Horizontal Frequency (kHz)	Vertical Frequency (Hz)
1	640 x 350	31.469	70.8	*11	1280 x 768	47.7	60
2	720 x 400	31.468	70.8	*12	1360 x 768	47.72	59.799
*3	640 x 480	31.469	59.94	*13	1366 x 768	47.7	60
4	640 x 480	37.5	75	*14	1280 x 1024	63.981	60.02
*5	800 x 600	37.879	60.317	15	1280 x 1024	79.98	75.02
6	800 x 600	46.875	75	*16	1680 x 1050	65.290	59.954
7	832 x 624	49.725	74.55	17	1600 x 1200	75.0	60
*8	1024 x 768	48.363	60	*18	1920 x 1080	67.5	60
9	1024 x 768	60.123	75.029				
*10	1280 x 720	44.772	59.855				

1 to 17: RGB mode
17: M3204C model only
*: HDMI/DVI mode

● DTV Mode

< M3204C >

	Component	HDMI/DVI (DTV)
480i	o	x
576i	o	x
480p	o	o
576p	o	o
720p	o	o
1080i	o	o
1080p	x	o

< M4716C >

	Component	HDMI/DVI (DTV)
480i	o	x
576i	o	x
480p	o	o
576p	o	o
720p	o	o
1080i	o	o
1080p	o	o

● Power Indicator

< M3204C >

Mode	Set
On Mode	Green
Sleep Mode	Amber
Off Mode	-

< M4716C >

Mode	Set
On Mode	Blue
Sleep Mode	Amber
Off Mode	-

Note



- DTV/PC selection on HDMI/DVI inputs is available for PC resolutions: 640x480/60 Hz, 1280x720/60 Hz, 1920x1080/60 Hz and DTV resolutions: 480p, 720p, 1080p.

Use this method to connect several products to a single PC. You can control several products at a time by connecting them to a single PC.

If the [Set ID] menu in [Option] is set to OFF, the monitor ID value should be set between 1 and 99.

Connecting the cable

Connect the RS-232C cable as shown in the picture.

You need to purchase a cable to connect the RS-232C socket as it is not provided as the accessory.

The RS-232C protocol is used for communication between the PC and product. You can turn the product on/off, select an input source or adjust the OSD menu from your PC.

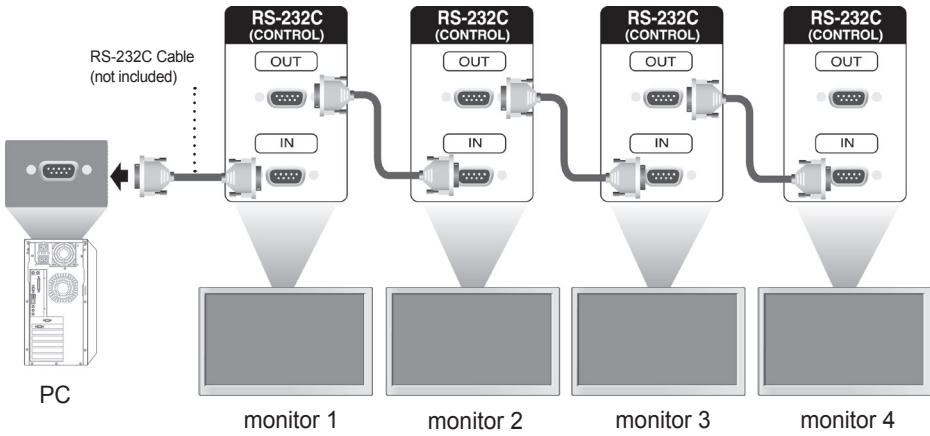

RS-232C Configurations

7-Wire Configurations (Standard RS-232C cable)

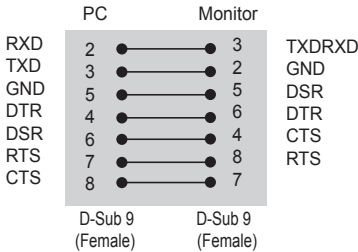

3-Wire Configurations (Not Standard)

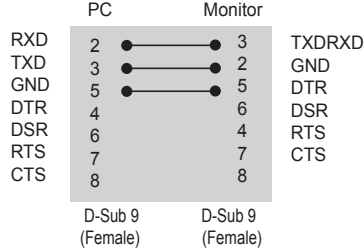

Communication Parameter

- ▶ Baud Rate : 9600 buad Rate (UART)
- ▶ Data Length : 8 bit
- ▶ Parity Bit : None
- ▶ Stop Bit : 1bit
- ▶ Flow Control : None
- ▶ Communication Code : ASCII code
- ▶ Use a crossed (reverse) cable

 Command Reference List

	COMMAND 1	COMMAND 2	DATA1	DATA2	DATA3
01. Power	k	a	00H to 01H		
02. Input Select	k	b	02H to 09H		
03. Aspect Ratio	k	c	01H to 1FH		
04. Screen Mute	k	d	00H to 01H		
05. Volume Mute	k	e	00H to 01H		
06. Volume Control	k	f	00H to 64H		
07. Contrast	k	g	00H to 64H		
08. Brightness	k	h	00H to 64H		
09. Color	k	i	00H to 64H		
10. Tint	k	j	00H to 64H		
11. Sharpness	k	k	00H to 64H		
12. OSD Select	k	l	00H to 01H		
13. Remote Lock/ key Lock	k	m	00H to 01H		
14. Balance	k	t	00H to 64H		
15. Color Temperature	k	u	00H to 02H		
16. Abnormal state	k	z	FFH		
17. ISM mode	j	p	01H to 08H		
18. Auto configuration	j	u	01H		
19. Key	m	c	Key Code		
20. Tile Mode	d	d	00H to 55H		
21. Tile H Position	d	e	00H to 14H		
22. Tile V Position	d	f	00H to 14H		
23. Tile H Size	d	g	00H to 64H		
24. Tile V Size	d	h	00H to 64H		
25. Tile ID Set	d	i	00H to 19H		
26. Natural Mode (In Tile mode)	d	j	00H to 01H		
27. Picture mode(PSM)	d	x	00H to 06H		
28. Sound mode	d	y	01H to 05H		
29. Fan Fault check	d	w	FFH		
30. Elapsed time return	d	l	FFH		
31. Temperature value	d	n	FFH		
32. Lamp fault check	d	p	FFH		
33. Auto Volume	d	u	00H to 01H		
34. Speaker	d	v	00H to 01H		
35. Time	f	a	00H to 06H	00H to 17H	00H to 3BH
36. On Timer (On/Off Timer) Time	f	d	F1H to F4H E0H to E4H 01H to 80H	00H to 17H	00H to 3BH
37. Off Timer (On/zOff Timer) Time	f	e	F1H to F4H E0H to E4H 01H to 80H	00H to 17H	00H to 3BH

Controlling the Multiple Product

	COMMAND 1	COMMAND 2	DATA1	DATA2	DATA3
38. Scheduling input select	f	u	F1H to F4H	02H to 09H	
39. Sleep Time	f	f	00H to 08H		
40. Auto Sleep	f	g	00H to 01H		
41. Power On Delay	f	h	00H to 64H		
42. Language	f	i	00H to 09H		
43. DPM Select	f	j	00H to 01H		
44. Reset	f	k	00H to 02H		
45. Power Saving	f	l	00H to 03H		
46. Power Indicator	f	o	00H to 01H		
47. Logo Indicator (Only M3204C)	f	p	00H to 01H		
* The function may be disabled depending of the product.					
48. Serial no.	f	y	FFH		
49. S / W Version	f	z	FFH		
50. Input Select	x	b	20H to A0H		

● Transmission / Receiving Protocol

Transmission

[Command1][Command2][][Set ID][][Data][Cr]

- * [Command 1]: First command. (k, j, m, d, f, x)
- * [Command 2]: Second command.(a to u)
- * [Set ID]: Set up the Set ID number of product.
range : 01H to 63H. by setting '0', server can control all products.
- * In case of operating with more than 2 sets using set ID as '0' at the same time, it should not be checked the ack message. Because all sets will send the ack message, so it's impossible the check the whole ack messages.
- * [DATA]: To transmit command data.
Transmit 'FF' data to read status of command.
- * [Cr]: Carriage Return
ASCII code '0 x 0 D'
- * []: ASCII code Space (0 x 20)

OK Acknowledgement

[Command2][][Set ID][][OK][Data][x]

- * The Product transmits ACK (acknowledgement) based on this format when receiving normal data. At this time, if the data is data read mode, it indicates present status data. If the data is data write mode, it returns the data of the PC computer.

Error Acknowledgement

[Command2][][Set ID][][NG][Data][x]

- * If there is error, it returns NG

● Transmission / Receiving Protocol

01. Power(Command : a)

- ▶ To control Power On / Off of the Set.

Transmission

```
[k][a][ ][Set ID][ ][Data][Cr]
```

Data 0 : Power Off 1 : Power On

Acknowledgement

```
[a][ ][Set ID][ ][OK][Data][x]
```

- ▶ To show the status of Power On / Off.

Transmission

```
[k][a][ ][Set ID][ ][FF][Cr]
```

Acknowledgement

```
[a][ ][Set ID][ ][OK][Data][x]
```

Data 0 : Power Off 1 : Power On

02. Input Select (Command : b) (Main Picture Input)

- ▶ To select input source for the Set.
You can also select an input source using the INPUT button on the remote control.

Transmission

```
[k][b][ ][Set ID][ ][Data][Cr]
```

Data 2 : AV
4 : Component
7 : RGB (PC)
8 : HDMI (DTV)
9 : HDMI (PC)

Acknowledgement

```
[b][ ][Set ID][ ][OK][Data][x]
```

Data 2 : AV
4 : Component
7 : RGB (PC)
8 : HDMI (DTV)
9 : HDMI (PC)

● Transmission / Receiving Protocol

03. Aspect Ratio(Command : c) (Main picture format)

- ▶ To adjust the screen format.

You can also adjust the screen format using the ARC (Aspect Ratio Control) button on remote control or in the Screen menu.

Transmission

```
[k][c][ ][Set ID][ ][Data][Cr]
```

Data 1 : Normal Screen (4 : 3)

2 : Wide Scran (16 : 9)

4 : Zoom (AV)

6 : Original (AV)

7 : 14 : 9 (AV)

9 : Just Scan (HD DTV) * When the RGB, HDMI / DVI PC mode(1:1)

10 to 1F : Cinema Zoom 1 to 16

B : Full Wide

Acknowledgement

```
[c][ ][Set ID][ ][OK][Data][x]
```

04. Screen Mute(Command : d)

- ▶ To select screen mute on / off.

Transmission

```
[k][d][ ][Set ID][ ][Data][Cr]
```

Data 0 : Screen mute off (Picture on)

1 : Screen mute on (Picture off)

Acknowledgement

```
[d][ ][Set ID][ ][OK][Data][x]
```

● Transmission / Receiving Protocol

05. Volume Mute(Command : e)

▶ To control On/Off of the Volume Mute.

Transmission

```
[k][e][ ][Set ID][ ][Data][Cr]
```

Data 0 : Volume Mute On (Volume Off)

1 : Volume Mute Off (Volume On)

Acknowledgement

```
[e][ ][Set ID][ ][OK][Data][x]
```

Data 0 : Volume Mute On (Volume Off)

1 : Volume Mute Off (Volume On)

06. Volume Control(Command : f)

▶ To adjust Volume

Transmission

```
[k][f][ ][Set ID][ ][Data][Cr]
```

Data Min : 00H to Max : 64H

(Hexadecimal code)

Acknowledgement

```
[f][ ][Set ID][ ][OK][Data][x]
```

Data Min : 00H to Max : 64H

* Real Data Mapping

0 : STEP 0

:

A : STEP 10

:

F : STEP 15

10 : STEP 16

:

64 : STEP 100

● Transmission / Receiving Protocol

07. Contrast(Command : g)

- ▶ To adjust screen contrast.

You can also adjust the contrast in the Picture menu.

Transmission

```
[k][g][ ][Set ID][ ][Data][Cr]
```

Data Min : 00H to Max : 64H

Acknowledgement

```
[g][ ][Set ID][ ][OK][Data][x]
```

* Refer to 'Real data mapping' page A7.

08. Brightness(Command : h)

- ▶ To adjust screen brightness.

You can also adjust the brightness in the Picture menu.

Transmission

```
[k][h][ ][Set ID][ ][Data][Cr]
```

Data Min : 00H to Max : 64H

* Refer to 'Real data mapping' as shown below.

Acknowledgement

```
[h][ ][Set ID][ ][OK][Data][x]
```

* Refer to 'Real data mapping' page A7.

● Transmission / Receiving Protocol

09. Color(Command : i) (Video Timing only)

- ▶ To adjust the screen color.

You can also adjust the color in the Picture menu.

Transmission

```
[k][i][ ][Set ID][ ][Data][Cr]
```

Data Min : 00H to Max : 64H
(Hexadecimal code)

* Refer to 'Real data mapping' page A7.

Acknowledgement

```
[i][ ][Set ID][ ][OK][Data][x]
```

Data Min : 00H to Max : 64H

10. Tint(Command : j) (Video Timing only)

- ▶ To adjust the screen tint.

You can also adjust the tint in the Picture menu.

Transmission

```
[k][j][ ][Set ID][ ][Data][Cr]
```

Data Red : 00H to Green: 64H
(Hexadecimal code)

* Refer to 'Real data mapping' page A7.

Acknowledgement

```
[j][ ][Set ID][ ][OK][Data][x]
```

Data Red : 00H to Green : 64H

* Tint Real data mapping

0 : Step 0 to Red

:

64 : Step 100 to Green

● Transmission / Receiving Protocol

11. Sharpness(Command : k) (Video Timing only)

- ▶ To adjust the screen Sharpness.

You can also adjust the sharpness in the Picture menu.

Transmission

[k][k][][Set ID][][Data][Cr]

Data Min : 00H to Max : 64H
(Hexadecimal code)

* Refer to 'Real data mapping' page A7.

Acknowledgement

[k][][Set ID][][OK][Data][x]

Data Min : 00H to Max : 64H

12. OSD Select(Command : l)

- ▶ To control OSD on/off to the set.

Transmission

[k][l][][Set ID][][Data][Cr]

Data 0 : OSD Off 1 : OSD On

Acknowledgement

[l][][Set ID][][OK][Data][x]

Data 0 : OSD Off 1 : OSD On

13. Remote Lock /Key Lock (Command : m)

- ▶ To control Remote Lock on/off to the set.

This function, when controlling RS-232C, locks the remote control and the local keys.

Transmission

[k][m][][Set ID][][Data][Cr]

Data 0 : Off 1 : On

Acknowledgement

[m][][Set ID][][OK][Data][x]

Data 0 : Off 1 : On

● Transmission / Receiving Protocol

14 Balance(Command : t)

▶ To adjust the sound balance.

Transmission

[k][t][][Set ID][][Data][Cr]

Data Min : 00H to Max : 64H

(Hexadecimal code)

00H : Step L50

64H : Step R50

Acknowledgement

[t][][Set ID][][OK][Data][x]

Data Min : 00H to Max : 64H

00H : Step 0 to L50

64H : Step 100 to R50

* Balance : L50 to R50

15. Color Temperature (Command : u)

▶ To adjust the screen color temperature.

Transmission

[k][u][][Set ID][][Data][Cr]

Data 0 : Medium

1 : Cool

2 : Warm

Acknowledgement

[u][][Set ID][][OK][Data][x]

Data 0 : Medium

1 : Cool

2 : Warm

● Transmission / Receiving Protocol

16. Abnormal state (Command : z)

▶ Abnormal State : Used to Read the power off status when Stand-by mode.

Transmission

```
[k][z][ ][Set ID][ ][Data][Cr]
```

Data FF : Read

Acknowledgement

```
[z][ ][Set ID][ ][OK][Data][x]
```

- 0 : Normal (Power on and signal exist)
- 1 : No signal (Power on)
- 2 : Turn the monitor off by remote control
- 3 : Turn the monitor off by sleep time function
- 4 : Turn the monitor off by RS-232C function
- 8 : Turn the monitor off by off time function
- 9 : Turn the monitor off by auto off function

17. ISM mode(Command: j p)

▶ Used to select the afterimage preventing function.

Transmission

```
[j][p][ ][Set ID][ ][Data][Cr]
```

- Data
- 1H : Inversion
 - 2H : Orbiter
 - 4H : White Wash
 - 8H : Normal

Acknowledgement

```
[p][ ][Set ID][ ][OK][Data][x]
```

● Transmission / Receiving Protocol

18. Auto Configure(Command: j u)

- ▶ To adjust picture position and minimize image shaking automatically. it works only in RGB(PC) mode.

Transmission

[j][u][][Set ID][][Data][Cr]

Data 1 : To set

Acknowledgement

[u][][Set ID][][OK][Data][x]

19. Key(Command : m c)

- ▶ To send IR remote key code.

Transmission

[m][c][][Set ID][][Data][Cr]

Data Key code : Refer to page A 32.

Acknowledgement

[c][][Set ID][][OK][Data][x]

● Transmission / Receiving Protocol

20. Tile Mode(Command : d d)

▶ Change a Tile Mode.

Transmission

[d][d][][Set ID][][Data][x]

Data	Description
00 or 11	Tile mode is off.
12	1 x 2 mode(column x row)
13	1 x 3 mode
14	1 x 4 mode
...	...
55	5 x 5 mode

* The data can not be set to 0X or X0 except 00.

Acknowledgement

[d][][00][][OK/NG][Data][x]

● Transmission / Receiving Protocol

21. Tile H Position(Command : d e)

▶ To set the Horizontal position.

Transmission

[d][e][][Set ID][][Data][x]

Data Min : 00H to Max : 14H

00H : Step -10(Left)

14H : Step 10(Right)

Acknowledgement

[e][][Set ID][][OK/NG][Data][x]

22. Tile V Position(Command : d f)

▶ To set the Vertical position.

Transmission

[d][f][][Set ID][][Data][x]

Data Min : 00H to Max : 14H

00H : Step -10(Down)

14H : Step 10(Up)

Acknowledgement

[f][][Set ID][][OK/NG][Data][x]

● Transmission / Receiving Protocol

23. Tile H Size(Command : d g)

▶ To set the Horizontal size.

Transmission

[d][g][][Set ID][][Data][x]

Data Min : 00H to Max : 64H

* Refer to 'Real data mapping' page A7.

Acknowledgement

[g][][Set ID][][OK/NG][Data][x]

24. Tile V Size(Command : d h)

▶ To set the Vertical size.

Transmission

[d][h][][Set ID][][Data][x]

Data Min : 00H to Max : 64H

* Refer to 'Real data mapping' page A7

Acknowledgement

[h][][Set ID][][OK/NG][Data][x]

● Transmission / Receiving Protocol

25. Tile ID Set(Command : d i)

▶ To assign the Tile ID for Tiling function .

Transmission

```
[d][i][ ][Set ID][ ][Data][x]
```

Data Min : 00H to Max : 19H
(Hexadecimal code)

Acknowledgement

```
[i][ ][Set ID][ ][OK/NG][Data][x]
```

26 Natural Mode (In Tile mode) (Command : d j)

▶ To assign the Tile Natural mode for Tiling function .

Transmission

```
[d][j][ ][Set ID][ ][Data][x]
```

Data 0 : Natural Off
1 : Natural On
ff : Read Status

Acknowledgement

```
[j][ ][Set ID][ ][OK/NG][Data][x]
```

27. Picture Mode (Command : d x)

▶ To adjust the picture mode.

Transmission

```
[d][x][ ][Set ID][ ][Data][x]
```

Data Structure

Data(Hex)	MODE
00	Vivid
01	Standard
02	Cinema
03	Sport
04	Game
05	Export 1
06	Export 2

Acknowledgement

```
[x][ ][Set ID][ ][OK/NG][Data][x]
```

● Transmission / Receiving Protocol

28. Sound Mode (Command : d y)

▶ To adjust the Sound mode.

Transmission

[d][y][Set ID][Data][X]

Data Structure

Data(Hex)	Mode
01	Standard
02	Music
03	Cinema
04	sport
05	Game

Acknowledgement

[y][Set ID][OK/NG][Data][x]

29. Fan Fault check (Command : d w)

▶ To check the Fan fault of the TV.

Transmission

[d][w][Set ID][Data][x]

* The data is always FF(in Hex).

Data ff: Read Status

Acknowledgement

[w][Set ID][OK/NG][Data][x]

* Data is the status value of the Fan fault.

Data 0: Fan fault

1: Fan OK

2: N/A(Not Available)

● Transmission / Receiving Protocol

30. Elapsed time return(Command : d l)

▶ To read the elapsed time.

Transmission

```
[d][l][ ][Set ID][ ][Data][x]
```

* The data is always FF(in Hex).

Acknowledgement

```
[l][ ][Set ID][ ][OK/NG][Data][x]
```

* The data means used hours.
(Hexadecimal code)

31. Temperature value (Command : d n)

▶ To read the inside temperature value.

Transmission

```
[d][n][ ][Set ID][ ][Data][x]
```

* The data is always FF(in Hex).

Acknowledgement

```
[n][ ][Set ID][ ][OK/NG][Data][x]
```

* The data is 1 byte long in Hexadecimal.

32. Lamp fault Check(Command : d p)

▶ To check lamp fault.

Transmission

```
[d][p][ ][Set ID][ ][Data][x]
```

* The data is always FF(in Hex).

Acknowledgement

```
[p][ ][Set ID][ ][OK/NG][Data][x]
```

Data 0 : Lamp Fault

1 : Lamp OK

2 : N/A(DPM/Power Off)

 Transmission / Receiving Protocol

33. Auto volume (Command : d u)

- ▶ Automatically adjust the volume level.

Transmission

[d][u][][Set ID][][Data][x]

Data 0 : Off

1 : On

Acknowledgement

[u][][Set ID][][OK/NG][Data][x]

34. Speaker (Command : d v)

- ▶ Turn the speaker on or off.

Transmission

[d][v][][Set ID][][Data][x]

Data 0 : Off

1 : On

Acknowledgement

[v][][Set ID][][OK/NG][Data][x]

● Transmission / Receiving Protocol

35. Time (Command : f a)

▶ Set the current time.

Transmission

[f][a][Set ID][Data1][Data2][Data3][Cr]

[Data1]

- 0 : Monday
- 1 : Tuesday
- 2 : Wednesday
- 3 : Thursday
- 4 : Friday
- 5 : Saturday
- 6 : Sunday

[Data2]

0H to 17H (Hours)

[Data3]

00H to 3BH (Minutes)

Acknowledgement

[a][Set ID][OK/NG][Data1][Data2][Data3][x]

*When reading data, FFH is inputted for [Data1], [Data2] and [Data3].
In other cases, all are treated as NG.

● Transmission / Receiving Protocol

36. On Timer (On/Off Timer) Time (Command : f d)

▶ Set On Timer.

Transmission

[f][d][Set ID][Data1][Data2][Data3][Cr]

[Data1]

1. f1h to f4h(read one index)

f1: read 1st index of On Time List,

f2: read 2nd index of On Time List

f3: read 3rd index of On Time List

f4: read 4th index of On Time List

2. e1h~e4h(delete one index), e0h(delete all indexes)

e0: delete all indexes of On Time List

e1: delete 1st index of On Time List

e2: delete 2nd index of On Time List

e3: delete 3rd index of On Time List

e4: delete 4th index of On Time List

3. 01h to 80h (write) (Day of Week)

bit0 (01h) : Monday

bit1 (02h) : Tuesday

bit2 (04h) : Wednesday

bit3 (08h) : Thursday

bit4 (10h) : Friday

bit5 (20h) : Saturday

bit6 (40h) : Sunday

bit7 (80h) : Everyday

(1fh) : Monday to Friday

(3fh) : Monday to Saturday

(60h) : Saturday to Sunday

[Data 2]

00h to 17h (Hours)

[Data 3]

00h to 3bh (Minutes)

*When you read/delete the current on time list, all of [Data2][Data3] are have to be FFH.

ex1: fd 01 f1 ff ff - when you read 1st index of On Time List

ex2: fd 01 e1 ff ff - when you delete 1st index of On Time List

ex3: fd 01 3f 02 03 - when you write one On Time Data, "Monday to Saturday, 02:03"

Acknowledgement

[d][Set ID][OK][Data1][Data2][Data3][x]

● Transmission / Receiving Protocol

37. Off Timer (On/Off Timer) Time (Command : f e)
 ► Set Off Timer.

Transmission

```
[f][e][Set ID][Data1][Data2][Data3][Cr]
```

[Data 1]

1. f1h to f4h(read one index)
 f1: read 1st index of Off Time List
 f2: read 2nd index of Off Time List
 f3: read 3rd index of Off Time List
 f4: read 4th index of Off Time List

2. e1h to e4h(delete one index), e0h(delete all indexes)
 e0: delete all indexes of Off Time List
 e1: delete 1st index of Off Time List
 e2: delete 2nd index of Off Time List
 e3: delete 3rd index of Off Time List
 e4: delete 4th index of Off Time List

3. 01h to 80h (write) (Day of Week)
 bit0 (01h) : Monday
 bit1 (02h) : Tuesday
 bit2 (04h) : Wednesday
 bit3 (08h) : Thursday
 bit4 (10h) : Friday
 bit5 (20h) : Saturday
 bit6 (40h) : Sunday
 bit7 (80h) : Everyday
 (1fh) : Monday to Friday
 (3fh) : Monday to Saturday
 (60h) : Saturday to Sunday

[Data 2]

00h to 17h (Hours)

[Data 3]

00h to 3bh (Minutes)

*When you read/delete the current on time list, all of [Data2][Data3] are have to be FFh.

ex1: fd 01 f1 ff ff - when you read 1st index of Off Time List

ex2: fd 01 e1 ff ff - when you delete 1st index of Off Time List

ex3: fd 01 3f 02 03 - when you write one Off Time Data, "Monday to Saturday, 02:03")

Acknowledgement

```
[e][Set ID][OK][Data1][Data2][Data3][x]
```

● Transmission / Receiving Protocol

38. Scheduling Input select (Command : f u) (Main Picture Input)

► To select input source for TV depending on day.

Transmission

[f][u][][Set ID][][Data1][][Data2][Cr]

[Data 1]

1. f1h to f4h(write/read one index)

f1: read 1st index of On Time Input

f2: read 2nd index of On Time Input

f3: read 3rd index of On Time Input

f4: read 4th index of On Time Input

[Data 2]

Input

Data(Hex)	INPUT
02	AV
04	Component
07	RGB - PC
08	HDMI/DVI - HD-DVD
09	HDMI/DVI - PC

*When you read/delete the current On Time Input, [Data2] needs to be FFh.

(ex1: fu 01 f1 ff - when you read 1st index of On Time Input

ex2: fu 01 f3 02 - when you write one On Time Input Data in to 3rd index, "AV")

Acknowledgement

[u][][Set ID][][OK][Data1][Data2][x]
--

● Transmission / Receiving Protocol

39. Sleep Time (Command : f f)

▶ Set Sleep Time.

Transmission

[f][f][Set ID][Data][Cr]

Data

0 : Off

1 : 10

2 : 20

3 : 30

4 : 60

5 : 90

6 : 120

7 : 180

8 : 240

Acknowledgement

[f][Set ID][OK/NG][Data][x]

40. Auto Sleep (Command : f g)

▶ Set Auto Sleep.

Transmission

[f][g][Set ID][Data][Cr]

Data 0 : Off

1: On

Acknowledgement

[g][Set ID][OK/NG][Data][x]

● Transmission / Receiving Protocol

41. Power On Delay (Command : f h)

- ▶ Set the schedule delay when the power is turned on (Unit: second).

Transmission

```
[f][h][ ][Set ID][ ][Data][Cr]
```

Data : 00H to 64H (Data value)

* Refer to 'Real data mapping' page A7

Acknowledgement

```
[h][ ][Set ID][ ][OK/NG][Data][x]
```

42. Language (Command : f i)

- ▶ Set the OSD language.

Transmission

```
[f][i][ ][Set ID][ ][Data][Cr]
```

Data

- 0 : English
- 1 : French
- 2 : German
- 3 : Spanish
- 4 : Italian
- 5 : Portuguese
- 6 : Chinese
- 7 : Japanese
- 8 : Korean
- 9 : Russian

Acknowledgement

```
[i][ ][Set ID][ ][OK/NG][Data][x]
```

● Transmission / Receiving Protocol

43. DPM Select (Command : f j)

- ▶ Set the DPM (Display Power Management) function.

Transmission

[f][j][Set ID][Data][Cr]

Data 0 : Off
1 : On

Acknowledgement

[j][Set ID][OK/NG][Data][x]

44. Reset (Command : f k)

- ▶ Execute the Picture, Screen and Factory Reset functions.

Transmission

[f][k][Set ID][Data][Cr]

Data
0 : Picture Reset
1 : Screen Reset
2 : Factory Reset

Acknowledgement

[k][Set ID][OK/NG][Data][x]

● Transmission / Receiving Protocol

45. Power saving(Command : f l)

▶ To set the Power saving mode.

Transmission

```
[f][l][Set ID][Data][Cr]
```

Data 0 : Off

1: (static level 1)

2: (static level 2)

3: (static level 3)

Acknowledgement

```
[l][Set ID][OK/NG][Data][x]
```

46. Power Indicator (Command : f o)

▶ To set the LED for Power Indicator

Transmission

```
[f][o][Set ID][Data][Cr]
```

Data 0 : Off

1: On

Acknowledgement

```
[o][Set ID][OK/NG][Data][x]
```

● Transmission / Receiving Protocol

47. logo Indicator (Command : f p) (Only M3204C)

▶ To set the LED for Power Indicator

Transmission

```
[f][p][ ][Set ID][ ][Data][Cr]
```

Data 0 : Off

1 : On

Acknowledgement

```
[p][ ][Set ID][ ][OK/NG][Data][x]
```

* The function may be disabled depending of the product.

48. Serial no.Check (Command : f y)

▶ To read the serial numbers

Transmission

```
[f][y][ ][Set ID][ ][Data][Cr]
```

Data FF (to read the serial numbers)

Acknowledgement

```
[y][ ][Set ID][ ][OK/NG][Data1] ~ [Data13] [x]
```

* The data format is ASCII Code.

● Transmission / Receiving Protocol

49. S/W Version (Command : f z)

▶ Check the software version.

Transmission

```
[f][z][ ][Set ID][ ][Data][Cr]
```

Data FFH : Read

Acknowledgement

```
[z][ ][Set ID][ ][OK/NG][Data][x]
```

50. Input Select (Command : x b)

▶ To select input source for the Set.

Transmission

```
[x][b][ ][Set ID][ ][Data][Cr]
```

Data 20H : AV

40H : Component

60H : RGB (PC)

90H : HDMI/DVI (DTV)

A0H : HDMI/DVI (PC)

Acknowledgement

```
[b][ ][Set ID][ ][OK][Data][x]
```

Data 20H : AV

40H : Component

60H : RGB (PC)

90H : HDMI/DVI (DTV)

A0H : HDMI/DVI (PC)

Remote Control IR Code

Output waveform
single pulse, modulated with 37.917kHz signal at 455kHz

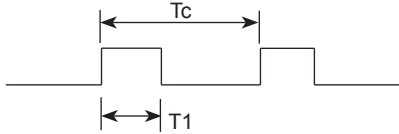

Carrier frequency
 $FCAR = 1 / Tc = fosc / 12$
 Duty ratio = $T1 / Tc = 1 / 3$

► Configuration of frame

▪ 1st frame

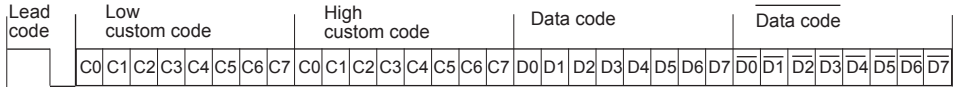

▪ Repeat frame

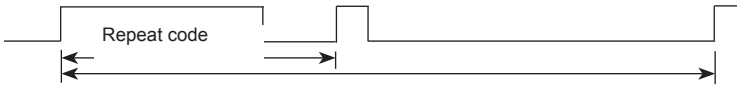

► Lead code

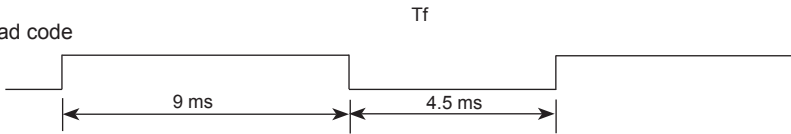

► Repeat code

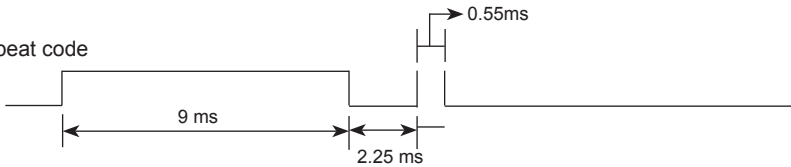

► Bit description

▪ Bit "0"

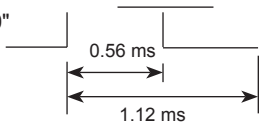

▪ Bit "1"

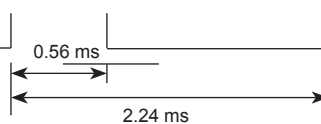

► Frame interval : Tf

▪ The waveform is transmitted as long as a key is depressed.



Tf = 108 ms @ 455 kHz

Code(Hex)	Function	Note
40	UP (▲)	R/C Button
41	DOWN (▼)	R/C Button
06	RIGHT (➤)	R/C Button
07	LEFT (➤)	R/C Button
08	POWER ON/OFF	R/C Button
C4	MONITOR ON	R/C Button (Discrete IR Code)
C5	MONITOR OFF	R/C Button (Discrete IR Code)
09	MUTE	R/C Button
95	Energy Saving	R/C Button
0B	INPUT	R/C Button
43	MENU	R/C Button
5B	EXIT	R/C Button
4D	PSM	R/C Button
44	OK	R/C Button
10	Number Key 0	R/C Button
11	Number Key 1	R/C Button
12	Number Key 2	R/C Button
13	Number Key 3	R/C Button
14	Number Key 4	R/C Button
15	Number Key 5	R/C Button
16	Number Key 6	R/C Button
17	Number Key 7	R/C Button
18	Number Key 8	R/C Button
19	Number Key 9	R/C Button
79	ARC(MARK)	R/C Button (Discrete IR Code)
02	Vol+	R/C Button
03	Vol-	R/C Button

Code(Hex)	Function	Note
E0	Bright [^] (Page UP)	R/C Button
E1	Bright ^v (Page Down)	R/C Button
28	BACK	R/C Button
99	AUTO CONFIC	R/C Button (Discrete IR Code)
72	ID ON(Red Color)	R/C Button
71	ID OFF(Green Color)	R/C Button
63	(Yellow Color)	R/C Button
61	(Blue Color)	R/C Button
7B	TILE	R/C Button
B0	▶	R/C Button
B1	■	R/C Button
BA		R/C Button
8F	◀◀	R/C Button
8E	▶▶	R/C Button
5A	AV	Discrete IR Code (Input AV Selection)
BF	COMPONENT	Discrete IR Code(Input COMPONENT Selection)
D5	RGB PC	Discrete IR Code (Input RGB PC Selection)
C6	HDMI/DVI	Discrete IR Code (Input HDMI/DVI Selection)
76	ARC (4:3)	Discrete IR Code (Only 4 : 3 mode)
77	ARC (16:9)	Discrete IR Code (Only 16 : 9 mode)
AF	ARC (ZOOM)	Discrete IR Code (Only ZOOM, Cinena ZOOM mode)

LICENSES

Supported licenses may differ by model. For more information of the licenses, visit www.lg.com.



HDMI, the HDMI logo and High-Definition Multimedia Interface are trademarks or registered trademarks of HDMI Licensing LLC.



Make sure to read the Important Precautions before using the product. Keep the Owner's Manual(CD) in an accessible place for future reference. The model and serial number of the SET is located on the back and one side of the SET. Record it below should you ever need service.

MODEL _____

SERIAL _____

ENERGY STAR is a set of power-saving guidelines issued by the U.S. Environmental Protection Agency(EPA).



As an ENERGY STAR Partner LGE U. S. A.,Inc. has determined that this product meets the ENERGY STAR guidelines for energy efficiency.

Important

WARRANTY VOID
IF REMOVED

Warranty void if removed.

WARNING -This is a class A product. In a domestic environment this product may cause radio interference in which case the user may be required to take adequate measures.

Temporary noise is normal when powering ON or OFF this device.