



PORTABLE MULTIMEDIA
PLAYER
OWNER'S MANUAL
MODEL: FM15

Before connecting, operating or adjusting this product,
please read this instruction booklet carefully and completely .

Designs and specifications are subject to change without
notice for improvement.



Table of Contents



Features	5	Connecting to the PC	24
Important safety instructions	6	Using the removeble storage device	24
CAUTION	8	Replacing firmware	25
Warning	10	Upgrading Firmware	25
Caution	10	Installation and conection	26
Industry Canada requirement	10	Battery Info	26
FCC COMPLIANCE STATEMENT	10	Inserting battery	26
FCC Warning	11	Connecting the player to the PC	26
Disposal of your old appliance	11	Disconnecting the player from the PC	27
Package contents	12	Basic operation	28
Connecting the neck strap	12	Turning on/off the power	28
Name of each component	13	Lock feature	28
Front/Side view	13	Volume control	28
Side/Rear view	13	Home menu screen	29
Installing software	14	Playing music files	30
Before installing the operating program	14	Music playing screen	30
LG Media Center	14	Play	30
LG Lyrics Center	16	Pause	30
Installing and running firmware updatder	17	Playing mode	31
Installing Win98SE Device Driver	20	Speed search of the play list	31
Installation of the Music Therapy	23	To search the next or previous music file ...	31

Table of Contents



Playback time information	31	External Input	40
A-B Repeat	32	Connecting to an external device	40
Bookmark feature	32	Recording through an external device	40
Playing the music list	32	Listening to the external recorded file	41
Playing the record list	33	Setting lower features	42
File error	33	Setup mode screen	42
Music therapy	33	Operating Setup feature	43
FM radio reception (Option)	34	Playing mode	43
FM radio reception screen	34	Sound effect	43
Listening to the FM radio	34	Screen layout	44
Preset/Non Preset Mode	34	Radio (Option)	44
Searching the FM radio stations	35	Record	45
Storing FM radio frequencies	35	Time	45
Deleting channels	36	General setting	45
Set/Cancel Mute	36	Running Recovery	46
Stereo/Mono switching	36	Using the application program	48
Recording FM radio broadcasting	37	LG Media Center	48
Listening to the radio recorded file	37	Auto Firmware updating	48
Recording	38	LG Lyrics Center	49
Recording screen	38	View the manual	49
Voice recording	38	Installation of the Adobe Acrobat Reader	49
Listening to the voice recorded file	39	Troubleshooting	50

Table of Contents



Specifications	51
Supported File Spec	52
http://www.lge.com	54

Features



Removable disk

You can copy and store files on the Windows Explorer.

Support USB 2.0 full speed

The user can download files at a fast speed.

Encoding

Through Line-in port of the player, the user can encode music to the MP3 player format.

FM reception (See on the page [12](#) 'Options By Model')

With auto frequency selection feature, the user can conveniently listen to FM radio broadcasting.

Text viewer

The text viewer feature is convenient for listening to music or studying a foreign language.

Firmware upgrading

You can upgrade your firmware to the newest one.

Music therapy

The music therapy feature helps user refresh, sleep better, and concentrate better with music with special functions or good for health.



The music therapy feature may not be provided depending on the product model.

DRM feature

What is the DRM? The DRM refers to the technologies and services that prevent unauthorized use of the digital contents and that protect the related parties of the intellectual property rights.

This product supports Portable Device DRM(PDDRM).



The DRM-enabled music file is encrypted so that editing the ID3 tag and lyrics is impossible.

Important safety instructions



Please follow the safety instructions closely to reduce the risk of accidents or damage to equipment. Safety instructions are divided into Warning and Attention. Keep this manual in an easily accessible place.



Caution

Not following the instruction may result in a light accident or damage.



Warning

Not following the instruction may result in death or serious injury.



Warning



Do not place an object on the product.



Keep this product away from heat.



Do not disassemble, repair, or remodel the product.



Caution



Do not use this product while driving.



Do not drop an object or give shock on the product.



Clean the Player with soft cloth.

Important safety instructions



Keep your computing environment clean and free of dust.



Do not place the player near a magnet or within the magnetic field.



Note that the player may malfunction in an electrostatic environment.



Do not insert a metallic object (coins or hair pins, etc.) or flammable objects in the product. Do not drop such objects on the product either.

Do not use the earphones loud while walking, especially on the crosswalks.

Stop using earphones or lower the volume when you have ringing in your ears.

Careful that headphones or earphones do not slip into the subway doors or automatic doors.



Do not operate the Player near water, dust, or soot.

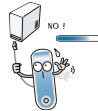

Do not disconnect the USB cable. Do not turn off the player while the USB cable is connected. Otherwise, the data may get lost.



Back up important data. (Note that the manufacturer is not responsible for the loss of major data caused by the user's mistake.)

Listening to the music loud for a long time may compromise your hearing ability.

Do not use earphones while riding bicycles and motor cycles or driving a car.

Check the volume before using a headphone. If headphones are used at high volume for more than 30 minutes, it may result in noise-induced hearing damage.

Important safety instructions



CAUTION

PLEASE READ AND OBSERVE ALL WARNINGS AND INSTRUCTIONS IN THIS OWNER MANUAL AND THOSE MARKED ON THE UNIT. RETAIN THIS BOOKLET FOR FUTURE REFERENCE.

This set has been designed and manufactured to assure personal safety. Improper use can result in electric shock or fire hazard. The safeguards incorporated in this unit will protect you if you observe the following procedures for installation, use, and servicing. This unit does not contain any parts that can be repaired by the user.

DO NOT REMOVE THE CABINET COVER, OR YOU MAY BE EXPOSED TO DANGEROUS VOLTAGE. REFER SERVICING TO QUALIFIED SERVICE PERSONNEL ONLY.

1. Read these instructions.
 - All these safety and operating instructions should be read before the product is operated.
2. Keep these instructions.
 - The safety, operating and use instructions should be retained for future reference.
3. Heed all warnings.
 - All warnings on the product and in the operating instructions should be adhered to.
4. Follow all instructions.
 - All operating and use instructions should be followed.

5. Do not use this apparatus near water.
 - For example: near a bath tub, wash bowl, kitchen sink, laundry tub, in a wet basement; or near a swimming pool; and like.
6. Clean only with dry cloth.
 - Unplug this product from the wall outlet before cleaning. Do not use liquid cleaners.
7. Do not block any ventilation openings. Install in accordance with the manufacturer's instructions.
 - Slots and openings in the cabinet are provided for ventilation and to ensure reliable operation of the product and to protect it from over-heating.
 - The openings should never be blocked by placing the product on a bed, sofa, rug or other similar surface. This product should not be placed in a built-in installation such as a bookcase or rack unless proper ventilation is provided or the manufacturer instructions have been adhered to.
 - Important Safety Instructions
8. Do not install near any heat sources such as radiators, heat registers, stoves, or other apparatus (including amplifiers) that produce heat.
9. Do not defeat the safety purpose of the polarized or grounding-type plug. A polarized plug has two blades with one wider than the other. A grounding type plug has two blades and a third grounding prong. The wide blade or the third prong are provided for your safety.

Important safety instructions



- If the provided plug does not fit into your outlet, consult an electrician for replacement of the obsolete outlet.
- 10. Protect the power cord from being walked on or pinched particularly at plugs, convenience receptacles, and the point where they exit from the apparatus.
- 11. Only use attachments/accessories specified by the manufacturer.
- 12. Use only with the cart, stand, tripod, bracket, or table specified by the manufacturer, or sold with apparatus.
 - When a cart is used, use caution when moving the cart/apparatus combination to avoid injury from tip over.
- 13. Unplug this apparatus during lightning storms or when unused for long periods of time.



- 14. Refer all servicing to qualified service personnel.

Servicing is required when the apparatus has been damaged in any way, such as power- supply cord or plug is damaged, liquid has been spilled or objects have fallen into the apparatus, the apparatus has been exposed to rain or moisture, does not operate normally, or has been dropped.

Important safety instructions



Warning

- To reduce the risk of fire or electric shock, do not expose this appliance to rain or moisture.

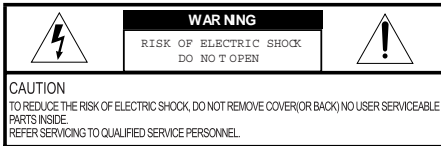

Caution

- The appliance is not intended for use by young children or infirm persons without supervision.
- Young Children should be supervised to ensure that they do not play appliance.
- Use of controls or adjustments or performance of procedures other than those specified herein may

Industry Canada requirement

- This Class B digital apparatus complies with Canadian ICES-003.
- Cet appareil numérique de la classe B est conforme qa la norme à NMB-003 du Canada.

FCC COMPLIANCE STATEMENT

This equipment has been tested and found to comply with the limits for a Class B digital device, pursuant to Part 15 of FCC Rules. These limits are designed to provide reasonable protection against harmful interference in a residential installation. This equipment generates, uses, and can radiate radio frequency energy and, if not installed and used in accordance with the instructions, may cause harmful interference to radio communications. However, there is no guarantee that interference will not occur in a particular installation. If this equipment does cause harmful interference to radio or television reception, which can be determined by turning the equipment off and on, the user is encouraged to try to correct the interference by one or more of the following measures:

- Reorient or relocate the receiving antenna.
- Increase the separation between the equipment and receiver.
- Connect the equipment into an outlet on a circuit different from that to which the receiver is connected.
- Consult the dealer or an Authorized Service Center for help.

Important safety instructions



FCC Warning

- Changes or modifications not expressly approved by the party responsible for compliance could void the user's authority to operate the equipment.
- This MP3 PLAYER is for use only with UL listed personal computers that have installation instructions detailing user installation of card cage accessory.



Tested to Comply
with FCC Standards

FOR HOME OR OFFICE USE

Disposal of your old appliance



1. When this crossed-out wheeled bin symbol is attached to a product it means the product is covered by the European Directive 2002/96/EC.
2. All electrical and electronic products should be disposed of separately from the municipal waste stream via designated collection facilities

appointed by the government or the local authorities.

3. The correct disposal of your old appliance will help prevent potential negative consequences for the environment and human health.
4. For more detailed information about disposal of your old appliance, please contact your city office, waste disposal service or the shop where you purchased the product.
 - The lithium battery contains lithium and can explode if it is not properly handled or disposed of.
 - Replace only with a battery of the type recommended by LG.
 - Caution: Danger of explosion if battery is incorrectly replaced. Replace only with the same or equivalent type recommended by LG. Dispose of used batteries according to the manufacturer's instructions.



Package contents



Main body



Line-in cable



USB cable



Quick setup guide



Software CD



Battery
(AAA-type 1EU)



Neck strap



Earphones

 Contents of the product are subject to change without prior notice for functional improvement.

Options By Model

Model Names	FM	Voice Recording	Line-in
MF-FM15S	O	O	O
MF-FM15E	X	O	O

Connecting the neck strap

To connect the neck strap to the unit

1. Turn the lower part of neck strap in the direction of arrows and detach it from the upper part.



2. Put a neck strap string into the ring of the main unit and put the lower part into the string as arrow shows.



3. When the main unit and neck strap are connected, attach the lower part of neck strap to the upper part by inserting and turning.

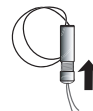

Name of each component



Front/Side view

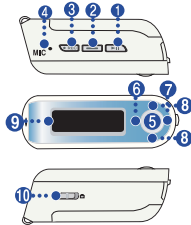

1. ON/OFF/PLAY/PAUSE
2. B-MARK (Bookmark)/Repeat
3. REC
4. MIC (microphone)
5. MENU / Select button
 - Goes to Home menu (upon pressing the button for two seconds or longer.)
6. REW / Search button
7. FF / Search button
8. Volume Control
9. Display
10. Hold

Side/Rear view

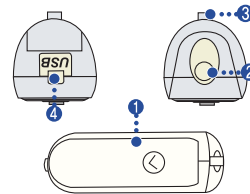

1. Battery Cover
2. Earphones connector
3. Neck strap holder
4. USB connector

Installing software



Before installing the operating program

Check the specifications of your PC before using LG portable Flash MP3 Player.

Minimum system requirements

- CD ROM Drive
- Pentium 3 or higher level CPU / 128MB or larger memory
- 100MB or larger hard disk space, 800 x 600 mode
- Hi-color (16 bit) or higher level vide card, Sound card

LG Media Center

- **Windows 2000** : Windows Media Player 9 or higher / Direct x 8.1 or higher/ Internet Explorer 6.0 or higher
- **Windows XP** : Windows Media Player 10 or higher / Internet Explorer 6.0 or higher
- Windows Media Player or Internet Explorer will be automatically installed during installation of the LG Media Center. Internet Explorer is only installed on an internet enabled PC.

LG Lyrics Center

- Windows 98SE / ME / 2000 / XP

Music therapy

- Windows 98SE / ME / 2000 / XP, Windows Media Player 9 or higher

LG Media Center

1. Insert the operation program CD into the CD ROM.
2. Select the LG Media Center.



3. Follow the displayed instructions.
4. Read the License Agreement. Select the checkbox, and click on [Next] button.

Installing software



5. Select the installation path, and click on [Next] button.

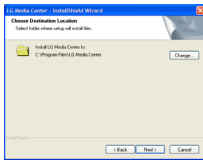

6. Click on [Install] button to start installation.

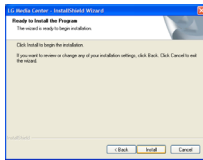

7. During installation of the LG Media Center, the user can install the Windows Media Player and

the Internet Explorer for the operating environment.

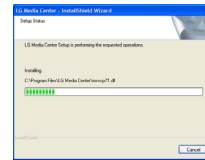

8. After finishing the installation, click on [Finish] button.

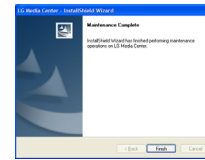

9. Click on Start > All Programs > LG Media Center to start the program.

Installing software



8. Program installation will start.

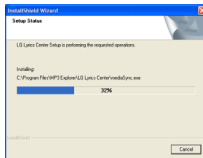

9. Click on [Yes] button.

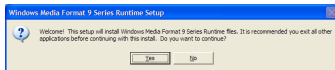

10. Windows media format installation screen will appear. Click on [Yes] button.

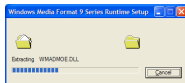
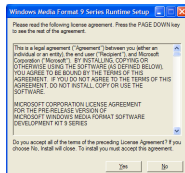

11. Click on [OK] button to finish installation of the program.

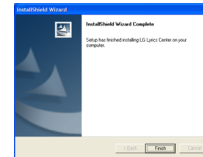
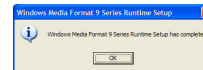

12. Click on Start > All programs > LG Lyrics Center to start the program.

Installing and running firmware updater

Before the initial use of MP3 player, install first the firmware updater to your PC. The user can update the firmware for addition and change of features of the player and for functional improvement.

- ✓ Do not connect MP3 player to the PC when updating firmware.
- ✓ You must backup your data before updating your firmware. We do not take any responsibilities for data loss if you do not backup.

Installing software



1. Insert the installation CD-ROM into you CD-ROM drive.
2. Run the firmware updater.
3. Installshield wizard starts. Click [Next].
4. Read the License Agreement. Select the checkbox, and click on [Next] button.

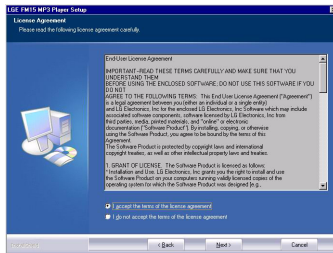

5. Select the installation path, and click on [Next] button.

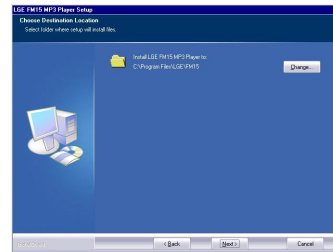

6. Click on [Install] button to start installation.

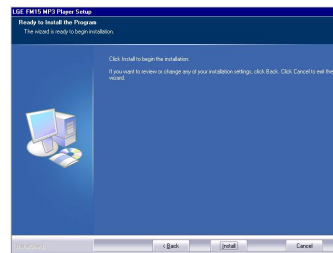

Installing software

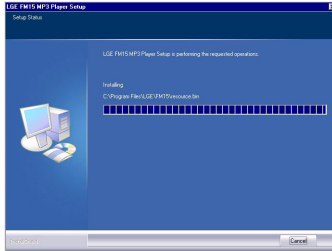

7. After finishing the installation, click on [Finish] button.
 - ✓ You may need to restart the computer, depending on your system environment.

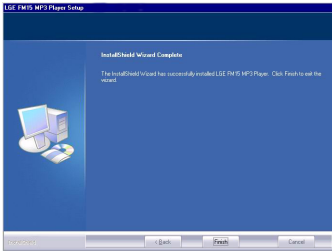

8. Select [Start] > [All Programs] > [LGE FM15 MP3 Player] > [Firmware Download]
9. Connect the mp3 player to a USB port on your computer.
10. Check the current firmware version, when the LGE MP3 Firmware download window appears.
11. If you want to format, check 'Data area formatting' in the download option.
 - ✓ All files will be deleted from the player. Back up your data before executing this option.
 - ✓ We recommend the "format data area".
12. Click [Start] to run the firmware updater.
 - ✓ Make sure your connection is solid while updating. It may result in the data loss or damage to the player.
13. When the update finishes, remove the USB connector by 'safely removing hardware'.
14. Check the updated firmware version.

Installing software



Installing Win98SE Device Driver

1. Insert the installation CD-ROM into you CD-ROM drive.
2. When you run the firmware updater, the driver for windows 98SE will be also installed.
3. Reboot the PC, and connect the MP3 player to the USB port.
4. The installed device driver can be used as a portable disk in the Windows Explorer.
5. Check the installation status in System Properties as shown below.

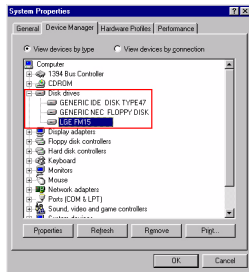

In case the player is not recognized automatically on Win98SE

1. Connect the player to the computer.
2. Select the LGE FM 15 in the system properties and click [Properties].

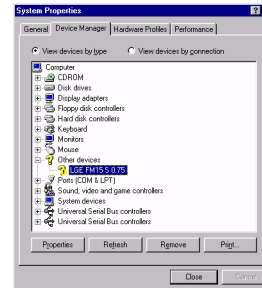

Installing software



3. Click the [Reinstall Driver].



4. Update Device Driver Wizard appears. Click [Next].



5. Select the Search for the best driver for your device and click [Next].

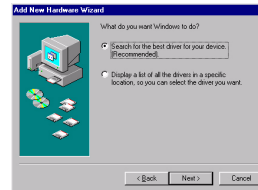

6. Locate the folder where the installation files are stored and click [Next].



Installing software



7. When the installation is complete, click [Next].

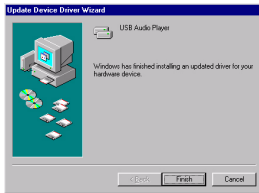

8. The installed device driver can be used as a removable storage disk in the Windows Explorer.
9. Check the installation status in System Properties as shown below.

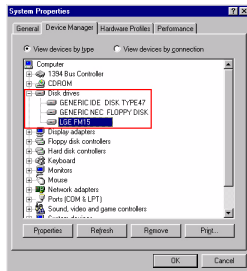

Installing software



Installation of the Music Therapy

The music therapy helps user refresh, sleep better, and concentrate better with music with special functions or good for health.

1. Insert the operating program CD into the drive.
2. Select Music Therapy.
3. After the program is installed, a shortcut icon will be created under Start > All Programs > Music Therapy.
4. Connect the MP3 player to the USB port of the PC.

5. Click on Download button. Then, the therapy music file will be downloaded to the MP3 player.



 Music Therapy files will refresh the user.

Connecting to the PC



Using the removable storage device

1. Connect one end of the USB cable to the USB port of the PC and the other to the USB port of the player.
 - ✓ Check whether both ends of the cable are correctly plugged in.
2. Check whether a new drive has been added in the Windows Explorer in the PC.
 - 📁 The drive name may differ depending on the OS.

3. Drag the file you want to copy to the removable disk.

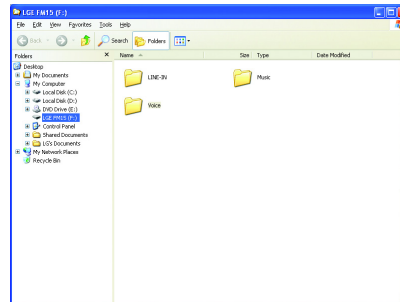

- ✓ Disconnecting the USB cable while the file is being copied may cause malfunctioning of the player.

Replacing firmware



Upgrading Firmware

Updating firmware manually.



- ✓ Do not connect MP3 player to the PC when updating firmware.
- 1. Check the model number at the company website, and download the latest version.
 - <http://www.lge.com> > Support > Download > Software
- 2. Decompress the downloaded files. Then, setup file will be displayed.
- 3. Click setup file to start the Installshield wizard.
 - 📄 If you have the previous version installed, it installs the new version after deleting the previous version automatically.
- 4. Click [Next].
- 5. Read the License Agreement. Select the checkbox, and click on [Next] button.
- 6. Select the installation path, and click on [Next] button.
- 7. Click on [Install] button to start installation.
- 8. After finishing the installation, click on [Finish] button.
- 9. Select Start > All Programs > LGE FM15 MP3 Player > Firmware Download to start the program.

Installation and connection



Battery Info

This product does not come with an AC adapter.

- Playback time : Max 18 hrs (In the case of MP3 128Kbps/44.1KHz, EQ Normal, Volume 15 and alkaline battery)
- When the battery is almost used up,  icon will appear.
- When the battery is at a certain level,  icon will be displayed for two seconds and the player will be turned off.

Inserting battery

1. Open the battery cover by sliding it down.
2. Insert one AAA-type battery with +/- aligned.
3. Close the battery cover.

Notice

- ✓ When battery leaked, clean the chamber and replace it with new one.
- ✓ Remove battery when not used for long.

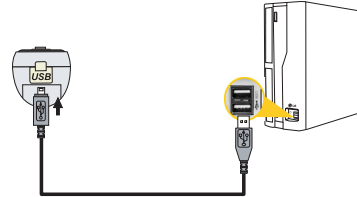

Connecting the player to the PC

1. Connect one end of the USB cable to the USB port of the PC and the other to the USB port of the player.
 - Check whether both ends are correctly plugged in.



2. When the cable is connected, the following will be displayed on the LCD



3. In case of a correct connection, the  icon will be displayed on the taskbar of the PC.
 -  The icon shapes on the task bar may differ depending on the operating environment of the PC.

Installation and connection



Disconnecting the player from the PC

This feature is to safely remove the player from the PC after uploading or downloading the files.

1. Double-click on Remove Hardware  icon on the taskbar of the PC.
2. Click on [Stop] button when the window appears.

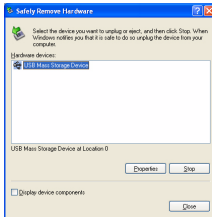

3. Click on [OK] button.

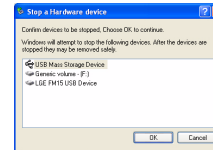

4. After a message that the large-capacity USB storage can be safely removed is displayed, remove the player from the PC.
- ✓ If the USB cable is disconnected while the player is connected to the PC to store or delete the file, the data may get lost.

Basic operation



Turning on/off the power





1. Press and hold ON/OFF button for more than 1 second to turn on, and repeat it to turn off for more than 3 seconds.

 It may take time to load upon rebuilding.



Lock feature

This feature is to lock all feature buttons to prevent malfunctioning of the player.

1. Push  button in arrow directions to lock the player.
 - Upon locked status,  will be displayed on the LCD. Upon pressing of each button,  will appear for two seconds and disappear.
2. Push  button to the opposite direction of the arrow key and unlock the device.
 -  icon will appear and then disappear.

Volume control

1. Control the volume by moving the volume control button to the direction of + or -.
 - The volume level can be adjusted by 31 steps. (Min:00 ~ Max:30)
 - Pressing and holding the button will increase or decrease the volume gradually.
 - The default volume is 15.

If you leave the display for three seconds, the Volume will disappear.

 Volume automatically resets to 20 when restarted if your player's volume level has been set to higher than 21.

Basic operation



Home menu screen

1. Press and hold MENU button to open home menu.

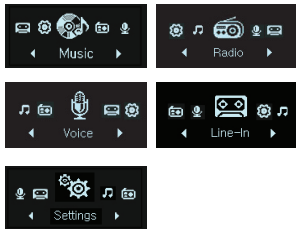

2. Press FF/REW button to select the mode.
 3. Press MENU button to display the selected mode.
- The initial screen consists of total five modes.
 - Home menu appears if MENU button is pressed for longer than 2 seconds during Play / Stop mode.

Playing music files



Music playing screen

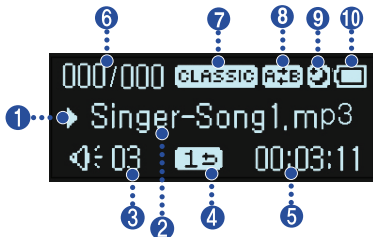

1. Play/Pause display
2. Song information display
3. Volume display
4. Play mode display
5. Playback time (upon playing)
6. Song play order display
7. EQ
8. Bookmark/A-B (Repeat)
9. Sleep Mode
10. Battery status

Play

1. Press and hold MENU button to open the home menu.
2. Push FF/REW button to select the [Music] mode.



3. Pressing MENU button will open Music Play screen.



4. Press PLAY/PAUSE button to play the music files.

Pause

1. Press PLAY/PAUSE button once to pause while playing.
 - Even in Pause/Stop status, song information can be displayed.

Playing music files



2. Press PLAY/PAUSE button again to resume playing.

Playing mode

1. Press REC button shortly while paused or while playing back.
2. Upon each pressing, the Play mode will change.

Description	GUI feature
Play all	Plays all songs.
Repeat all	Repeats all songs.
Random repeat	Randomly repeats all songs.
Repeat One	Repeats one song.
Play Folder	Play all songs in a folder.
Folder repeat	Repeat all songs in a folder.
Folder Random Repeat	Randomly repeat all songs in a folder.

Speed search of the play list

1. Push FF/REW button for two seconds or longer to fast search.
 - You may play a song by jumping to a particular point.

To search the next or previous music file

1. Push FF/REW button shortly to search the next or previous music file.
2. Push FF/REW button shortly to the left five seconds after playing starts. Then, the current song will play from the beginning.

Playback time information

1. Press REC button for two seconds or longer while paused or while playing back.
2. You can press the button to flip between playback time mode and remaining time mode.



Playing music files

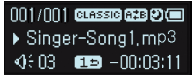

A-B Repeat

A-B Repeat feature is only applicable to a song which is being played.

1. Press B-MARK button shortly to set the starting point during playing.
 - icon will appear on the display.
2. To select the ending point, shortly press B-MARK button again.
 - icon will appear on the display, and the selected node will be repeated.
3. To cancel the feature, shortly press B-MARK button again.

Bookmark feature

1. Press B-MARK button for two seconds or longer to set the Bookmark.
 - icon will appear.
- The user cannot use the A-B Repeat feature when the Bookmark feature is set.

2. Press B-MARK button shortly while listening to another song or another part of the song.
 - It automatically searches the bookmarked point and plays.
3. To cancel the bookmark, press B-MARK button for two seconds or longer.
 - icon will disappear.

Playing the music list

The user can easily search or play files using the browser.

1. Press MENU button shortly in the music mode. Then, the browser screen will appear.



2. Go to the item using Vol +/- button in the browser screen, and press MENU, PLAY/PAUSE, or push FF button shortly.
 - Press MENU button for two seconds or longer to go to Home menu.



Playing music files



Playing the record list

1. Press MENU button shortly in the music mode.
2. Choose a folder among FM, LINE-IN, or VOICE folders.
3. Navigate to the file you want to play in a particular folder and play it by pressing MENU or PLAY/PAUSE or push FF button.
 - F001.MP3: Radio recording file format
 - V001.MP3: Voice recorded file format
 - E001.MP3: External record file format

Maximum number of files to play

- You can play up to 400 files.

Maximum number of folders to be created

- You can create up to 50 folders.

-  When the files or folders exceed the above limit, the file or folder exceeding the limit don't appear in the list.

File error

When you select a file which cannot be played, the following message will be displayed.

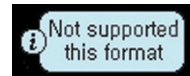

Music therapy

1. Press MENU button shortly while the player is playing the music or pausing.
2. Press MENU button to navigate to the Music Therapy folder and shortly press PLAY/PAUSE or push FF button.
3. Select the file, and press MENU, PLAY/PAUSE or push FF button to play.
 - Sound sleeping music: To help the user sleep sound
 - Concentration music: To help use to focus better
 - Refreshing music: To help user relieve and take a rest
 - Vitalizing music: To vitalize and energize the user
 -  See page [23](#) to reinstall the Music Therapy file.

FM radio reception (Option)



FM radio reception screen

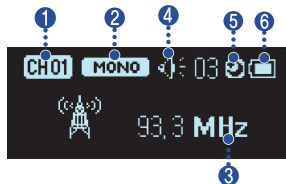

1. Channel display (only in Preset mode)
2. Mono/Stereo display
3. FM radio frequency display
4. Volume Information
5. Sleep mode
6. Battery status

Listening to the FM radio

1. Press MENU button to select [Radio] mode.

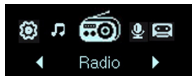

2. Press MENU button to display the FM radio reception screen.



Preset/Non Preset Mode

1. Press MENU button shortly while listening to the radio.
 - Preset mode is set.
 - Preset mode : When the existing radio channels are already set, it is called 'preset mode'.
 - **CH** display appears.
2. Shortly press the MENU button once again.
 - Non-Preset mode is set.
 - Non-Preset mode: When the existing radio channels are not already set, it is called 'Non-preset mode'.
 - **CH** display disappears.
3. No Preset channels are stored when MENU button is pressed in Non-Preset mode
 - **NoCH** will appear and then disappear.

FM radio reception (Option)





Searching the FM radio stations

Manually searching the FM radio stations

1. In Non-Preset mode, shortly pressing FF/REW button increase/decrease the frequencies by 0.05 MHz.
2. In Preset mode, shortly pushing FF/REW button will increase/decrease the frequencies by 1 preset.

Automatically searching the broadcasting stations

1. In Non-Preset mode, push FF/REW button for longer than 2 seconds to find the available radio station automatically.
2. To cancel the automatic search, push REW button during Forward search and push FF button during Rewind search.

-  Reception may be weak in some areas.
-  Earphones function as an antenna. Earphones of other manufacturers do not guarantee optimal performance.

Storing FM radio frequencies

Automatic channel setting

1. Press REC button for two seconds or longer to search and store radio channels in Non-Preset mode.
 - **CH01** icon will appear and the channels will be stored.
 -  In an area with weak reception, the detected channels may be less than 20.
2. Press REW button to stop automatic search.

Manually channel setting

1. In a Non-Preset mode, select a frequency to store as a Preset channel and press and hold B-MARK button.
2. When a browser screen appears, select a channel with Vol +/- button and press MENU button shortly.

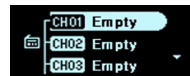

FM radio reception (Option)



3. When a message appears that "Save as a CH", select Yes and shortly press MENU button.

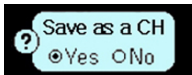

4. Stored channels can be scanned in a browser screen.



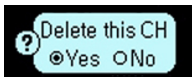

Deleting channels

1. While listening to the radio, press B-MARK button for two seconds or longer to delete the current channel.
2. When a message appears that "Delete this CH", select Yes and shortly press the MENU button.



- When a channel is deleted, we can still receive other channels. When there is no channel left, **NoCH** icon will blink.

Set/Cancel Mute

1. Press PLAY/PAUSE button during listening to radio to mute the sound.
 -  icon will appear and the sound will become mute.
2. Press any button to cancel the Mute.
 -  icon will disappear.

Stereo/Mono switching

Shortly press the B-MARK button.

- Press the button to toggle between **STEREO** and **MONO**.

FM radio reception (Option)



Recording FM radio broadcasting

1. Press REC button to start recording while listening to the radio.

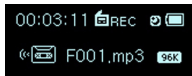

- REC icon will appear.
- Files will be stored in FM folder in a format 'F001.mp3'.
- If the memory is not enough to record, [Memory full not record] will appear. In this case, delete the files and secure the memory space.

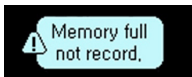

2. Press PLAY/PAUSE button to pause recording.

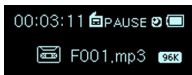

- PAUSE icon will appear.
3. By pressing PLAY/PAUSE button again, the user can resume recording.

4. Press REC button shortly again to end recording.



- SAVING icon will appear and then disappear.

Listening to the radio recorded file

1. Press and hold the MENU button to select the music mode.
 2. Press MENU button shortly while in music mode.
 3. Select the FM folder from the browser menu.
 4. Choose a recording file you want to hear and shortly press the MENU, PLAY/PAUSE or push FF button
- Files will be stored in FM folder in a format 'F001.mp3'.

Recording



Recording screen

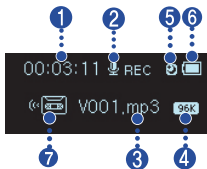

1. Recorded time display
2. Recording progress display
3. Recorded file name display
4. Recording quality display
5. Sleep mode
6. Battery status
7. Recording Status Display

Voice recording

1. Press and hold MENU button to open home menu.

2. Push FF/REW button to select the [Voice] mode.



3. Press MENU button in [Voice] mode .
4. Press REC button to start recording.

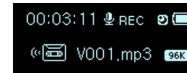

- icon will appear, and then recording will start.
 - The recorded files will be stored in VOICE folder in V001.MP3 format.
 - If the memory is not enough to record, [Memory full not record] will appear. Then, the data will be automatically stored and recording will stop.
 - The higher the quality is, the shorter the recording time is.
5. To stop recording, press REC button again.
 - icon will appear and then disappear.



Listening to the voice recorded file

1. Press and hold the MENU button to select the music mode.
2. Press MENU button shortly while in music mode.
3. Select the VOICE folder from the browser menu.
4. Choose a recording file you want to hear and shortly press the MENU, PLAY/PAUSE or push FF button.
 - Files will be stored in V001.mp3 format.

External Input



Connecting to an external device

1. Connect the Line-in cable to the line-out port of the external device and to the line-in port of the MP3 player.

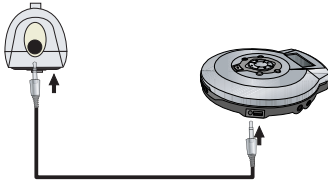

Recording through an external device

1. Press and hold the MENU button to open home menu.
2. Push FF/REW button to select [line-in] mode.



3. Press REC button to start recording.

- REC icon will appear, and then recording will start.
- The recorded files will be stored in LINE-IN folder in E001.MP3 format.
- The higher the quality is, the shorter the recording time is.
- If the memory capacity is not enough, [Memory full not record] message will appear. The file will be automatically stored and the recording will stop.



- When encoding files, set the volume of Line-in properly.
 - If the volume is too high or too low, the quality of encoded files might turn out to be bad.
4. To stop recording, press REC button again.
 - SAVING icon will appear and then disappear.

Recording quality	Maximum recording time (for 512 MB storage product)
96 Kbps	About 11.5 hours
128 Kbps	About 8.5 hours
192 Kbps	About 5.5 hours



Listening to the external recorded file

1. Press and hold the MENU button to select the music mode.
2. Press MENU button shortly while in music mode.
3. Select the LINE-IN folder from the browser menu.
4. Choose a recording file you want to hear and shortly press the MENU, PLAY/PAUSE or push FF button.
 - Files will be stored in E001.mp3 format.

Setting lower features



Setup mode screen

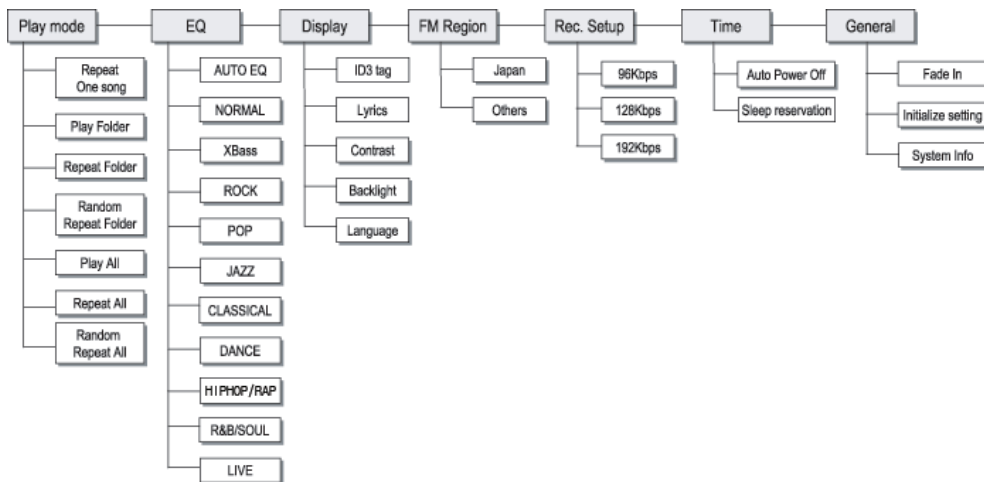

Setting lower features



Operating Setup feature

1. Press MENU button to open home menu.
2. Push FF/REW button to select the [Setting] mode.



3. Press MENU button shortly to display the sub menu.

- Push FF/REW button to navigate between menus.

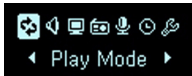

- Press MENU button to display the lower feature setting screen.
- Push REW button to go to the upper menu without setting the feature in the sub menu.
- Press MENU button for two seconds or longer to go to Home menu.
- Press MENU button shortly to go to the upper menu after setting the feature.

Playing mode

You can select the play mode you want.

Description	GUI feature
Play all	Plays all songs.
Repeat all	Repeats all songs.
Random repeat	Randomly repeats all songs.
Repeat One	Repeats one song.
Play Folder	Play all songs in a folder.
Folder repeat	Repeat all songs in a folder.
Folder Random Repeat	Randomly repeat all songs in a folder.

Sound effect

EQ mode: The user can set the sound effect.

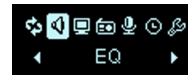

Setting lower features



AUTO EQ, NORMAL, XBass, ROCK, POP, JAZZ, CLASSICA, DANCE, HIPHOP/RAP, R&B/SOUL, LIVE

- NORMAL : Basic sound quality with no sound effect.
- XBass : Powerful sound with excellent dynamics.
- ROCK : Strong but smooth sound.
- POP : Realistic sound with enhanced mid-range frequency.
- JAZZ : Sweet and feeble sound.
- CLASSICAL : Detailed sound with enhanced mid-range frequency.
- DANCE : well-balanced sound between high and low frequencies
- HIPHOP/RAP : Sound with enhanced low and high frequency
- R&B/SOUL : Detailed sound with enhanced high frequency
- LIVE : Realistic sound with enhanced mid-range and high frequency

Screen layout

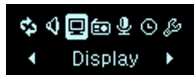

ID3 tag : Displays information of the music file.

- The user can select [On] or [Off].

- In case the user selects [On], the artist and the title of the ID3 tag will be displayed.

View Lyrics : Displays the lyrics of the music file.

- The user can select [On] or [Off].
You can view the lyrics only if the files include lyrics.

Contrast : The user can select the brightness of the lighting.

- The user can set between 0 and 9.

Backlight : The user can set the lighting time.

- The user can select 5 Sec, 10 Sec, 30 Sec, 1 MIN, or On.

 The light will not be turned off upon display of lyrics during the music is played.

Language : The user can set the language.

- English, Japanese, Traditional Chinese, Simplified Chinese, Korean, Russian, French, Portuguese, German, Spanish.

Radio (Option)



Setting lower features



Reception area : The user can set the reception area.

- The user can select [Japan] or [Others].

Record



Recording quality : The user can set the quality of the recorded file.

- The user can set 96Kbps, 128Kbps, upto 192Kbps.

Time



Auto power off : The player will be automatically turned off when the user does not use the function for a certain time while the player is not playing or recording a file.

- The user can select Off, 30 SEC, 1 MIN, 5 MIN, or 10 MIN.

- The Automatic Off feature does not function in the radio mode.

Sleep reservation : When the defined time passes, the player will be automatically turned off.

- The user can select Off, 10 MIN, 30 MIN, 1 Hour, or 2 Hours.
- If the user sets the sleep reservation, the player will automatically store files and turn off at the reserved time.
- After the player is turned off at the reserved time, the sleep reservation will be automatically cancelled.

General setting

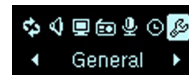

Fade in : The user can gradually increase the volume to protect ears.

- The user can select [On] or [Off].

Initializing setting : The user can initialize the setting of the player.

- The user can select Yes or No.

Setting lower features



System info : The user can check product information.

- The firmware version, the remaining memory space, and the total memory capacity are displayed.

Running Recovery

- ✓ Running a recovery will result in a total loss of data. Make sure to always back up important data. We do not take any responsibilities for data loss. Remove the battery to reset the system for the followings happens;

Run a recovery at the same symptoms since then.

- PC and player is not recognized properly
- Text appears broken and somewhat unreadable onscreen.
- Player does not work
- You cannot download or upload files

1. Select Start> All Programs > LG FM15 MP3 Player > Firmware download.

2. When the screen below appears, connect the mp3 player to the USB port of the computer while pressing the PLAY/PAUSE button.



3. Release the PLAY/PAUSE button when the device is recognized properly as seen in the progress bar completion status.

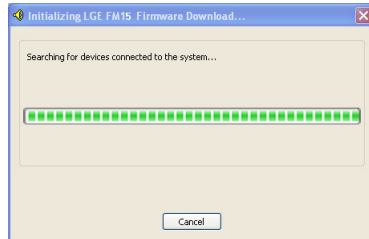

Setting lower features



4. To format the device, check the "Format data area" in the download option when the update screen appears.
 - ✓ All files will be deleted from the player. Please back up your data before executing this option.
 - We recommend the "format data area".
5. Click [Start] to run the Recovery.
6. Use the MP3 player when the recovery finishes.

Using the application program



LG Media Center

The LG Media Center program is an integrated data management program development for users to more conveniently use the Flash MP3 player.

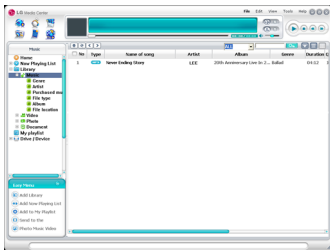

Features of the LG Media Center

- With the Media Library, the user can efficiently manage music files and download them to the MP3 player.
- Downloaded files are stored in a folder hierarchically.
Music > Artist > *.mp3
- You can create folder (50 folders maximum).
- To disable folder hierarchy, select No Hierarchy in the Synchronization > Enable hierarchy menu item.
Music > *.mp3

Auto Firmware updating

Connect the player to the PC where the LG Media Center is installed to download a new version of firmware.

📁 Functions only in the Internet-connected PC.

1. Connect one end of the USB cable to the USB port of the PC with the LG Media Center installed and the other to the USB port of the player.
2. Check whether a new drive has been added in the Windows Explorer in the PC.
3. The LG Media Center will compare the firmware versions of the player and the server. If it detects a new firmware version, it asks the user whether to update the version.
4. Check the current firmware version, when the LGE MP3 Firmware download window appears.
5. If you want to format, check 'Data area formatting' in the download option.
 - ✓ All files will be deleted from the player. Please back up your data before executing this option.
 - We recommend the "data area formatting".
6. Click [Start] to run the irmware updater.
 - ✓ Make sure your connection is solid while updating. It may result in the data loss or damage to the player.

Using the application program



7. When the update finishes, remove the USB connector by 'safely removing hardware'.
8. Turn on the MP3 player, and check the updated version of firmware.

- Before you download lyrics, you must check the model number and make sync with PC to enable lyrics to be displayed properly.
-  Run the program, and click on F1 Help. The user can view the Help menu.

LG Lyrics Center

The LG Lyrics Center program can automatically/ manually store the lyrics in the music file. It also can download/upload mp3 files to/from the portable device and control the volume.

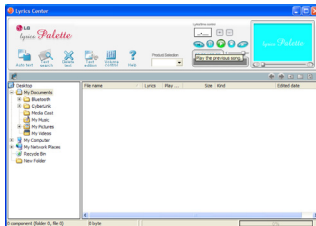

The user can store lyrics of the several songs at the same time. Stored files will be connected without requiring a separate program or tool, and can be downloaded to a large-capacity storage. The user can make volumes of several MP3 files same.

- A Windows Explorer-like UI providing maximum convenience for users.

View the manual

PDF document The user needs the Adobe Acrobat Reader to read the manual.

Installation of the Adobe Acrobat Reader

Click on Acrobat Reader for installation.

- Read the user manual.

Troubleshooting



Q: The player is not turned on.

A : Check whether the battery is remaining.

Q: The screen is blur.

A : Avoid direct sun rays and adjust the brightness.

A : Check the LCD brightness.

Q: The button does not function.

A : Check whether the Hold feature is active.

Q: The noise is severe during listening to the radio, and the reception is poor.

A : As the earphones function as an antenna, make sure it has any damage.

A : Change the directions of the player and the earphones gradually.

Q: After the firmware is updated, the player is not normally functioning.

A : Back up the data, and format the player.

Q: Sometimes files get downloaded but sometimes they don't.

A : Make sure the USB port is operational.

Q: Downloaded file or folder does not appear.

A : The maximum number of files or folder this player can play are 400 and 50 respectively. The file or folder exceeding the limit don't appear in the list. Delete

some music files or folders to see the files which are not previously listed.

Specifications



Type	Item	Specifications
Memory	Capacity	256MB / 512MB / 1GB
	File system	FAT12 / FAT16 / FAT32
PC	OS for MP3 Player Device	Win98SE / ME / 2000 / XP
	OS for LG Media Center	Win2000 / XP
	OS for LG Lyrics Center	Win98SE / ME / 2000 / XP
	Interface	USB2.0 Full Speed
General specifications	Dimensions	63(W) X 24(H) X 25(D)
	Weight	25g (with battery) / * Depends on the product model.
	Operating temperature	-5 C + 45 C
Audio	Frequency response	20Hz ~ 20kHz
	Signal-to-noise ratio	90dB
	Channel seperation	33dB (1kHz)
	Maximum output	7.5mW+7.5mW
FM radio (Option)	Frequency range	76.0~108.0MHz
	Signal-to-noise ratio	38dB (Mono)
	Channel seperation	25dB (1kHz)
	Antenna	Earphones antenna
Power supply	Battery	AAA-sized battery (DC 1.5V)
Playback time	Maximum 18 hours	(for 128Kbps/44.1 KHz, EQ normal, Vol 15)
Files	Audio	MP3 / WMA / WAV
Display	Display	Mono (Negative)

Specifications



Supported File Spec

MP3 Decoder

- Support MP3 decoding including Variable Bit Rate(VBR)

- ○ : Support both Stereo and Mono
- ○(s) : Only Stereo
- ○(m) : Only Mono

MP3 Decoder

kbps/kHz	MPEG 1 Layer 3			MPEG2 Layer3			MPEG2.5		
	44.1	48	32	22.05	24	16	11.025	12	8
8				○	○	○	○	○	○
16				○	○	○	○	○	○
24				○	○	○	○	○	○
32	○	○	○	○	○	○	○	○	○
40	○	○	○	○	○	○	○	○	○
48	○	○	○	○	○	○	○	○	○
56	○	○	○	○	○	○	○	○	○
64	○	○	○	○	○	○	○	○	○
80	○	○	○	○	○	○			
96	○	○	○	○	○	○			
112	○	○	○	○	○	○			
128	○	○	○	○	○	○			
144				○	○	○			
160	○	○	○	○	○	○			
192	○	○	○						
224	○	○	○						
256	○	○	○						
320	○	○	○						

Specifications



kbps/kHz	MPEG1 layer 1			MPEG1 Layer2		
	44.1	48	32	44.1	48	32
32				○	○	○
36	○	○	○			
48				○	○	○
56				○	○	○
64	○	○	○	○	○	○
80				○	○	○
96	○	○	○			
112				○	○	○
128	○	○	○	○	○	○
160	○	○	○	○	○	○
192	○	○	○	○	○	○
224	○	○	○	○	○	○
256	○	○	○	○	○	○
288	○	○	○			
320	○	○	○	○	○	○
352	○	○	○			
384	○	○	○	○	○	○
416	○	○	○			
448	○	○	○			

kbps/kHz	MPEG2 layer 1			MPEG2 Layer2		
	16	22.5	24	16	22.5	24
8				○	○	○
16				○	○	○
32	○	○	○	○	○	○
40				○	○	○
48	○	○	○	○	○	○
56	○	○	○	○	○	○
64	○	○	○	○	○	○
80	○	○	○	○	○	○
96	○	○	○	○	○	○
112	○	○	○	○	○	○
128	○	○	○	○	○	○
144	○	○	○	○	○	○
160	○	○	○	○	○	○
176	○	○	○			
192	○	○	○			
224	○	○	○			
256	○	○	○			

MP3 Encoder

- 44.1KHz, (96Kbps, 128Kbps, 192Kbps) Spec

Specifications



WMA Decoder

- Ver 4x, 7, 8 (○) Ver 9 (●) (ASF not supported)

WMA DECODER							
kbps/kHz	48	44.1	32	22.05	16	11.025	8
320		● (s)					
256		● (s)					
192	● (s), ○ (s)	● (s), ○ (s)					
160	● (s), ○ (s)	● (s), ○ (s)					
128	● (s), ○ (s)	● (s), ○					
96	● (s)	● (s), ○ (s)					
80	● (s)	● (s), ○ (s)	○ (s)				
64	● (s)	● (s), ○	○ (s)				
48		○	● (s)				
44			○ (s)				
40			○ (s)				
36			○ (s)				
32		○	○	● (s)			
22			○ (s)	○ (s)			
20			○ (m)	○	○ (s)		
16				○ (m)	○		
12					○ (m)		○ (s)
10					○ (m)		
8						○ (m)	○ (m)
6							○ (m)
5							○ (m)

WAV Decoder

WAV DECODER							
MS-ADPCM							
kbps/kHz	48	44.1	32	22.05	16	11.025	
4	○	○	○	○	○	○	○
IMA-ADPCM							
4	○	○	○	○	○	○	○
PCM							
4	○	○	○	○	○	○	○
16	○ (m)	○	○	○	○	○	○
24	○ (m)	○ (m)	○ (m)	○ (m)	○ (m)	○ (m)	○ (m)

<http://www.lge.com>

Information related to the product is available at this site.

- By updating the firmware, the user can improve the performance of the product.

