



LG

Life's Good

ENGLISH

FRANÇAIS

OWNER'S MANUAL

ELECTRIC RANGE

Please read this guide thoroughly before operating and keep it handy for reference at all times.

MODELS

LSC5683WS

LSC5683WB

LSC5683WW

Thank you for purchasing an LG electric oven.

Please record the model number and serial number of this unit for future reference. We also suggest that you record the details of any contact with LG (LG Electronics Canada, Inc.) concerning this unit.

Model No.: _____

Serial No.: _____

Dealer: _____

Dealer Phone No.: _____

Staple your receipt here to verify your retail purchase.

TABLE OF CONTENTS

| | | | |
|---|-------|---|-------|
| SAFETY..... | 3-8 | - Setting bake | 20-21 |
| - Important safety instructions | 3-7 | - Setting timed bake | 22 |
| - Appliance outlets..... | 8 | - Setting delayed timed bake..... | 23 |
| SURFACE CONTROLS COOKING..... | 9-13 | - Setting broil | 23 |
| - "PF" "HS" message..... | 9 | - Recommended broiling guide | 24 |
| - Locations of the radiant surface elements and controls | 9 | - Setting convection bake..... | 25 |
| - Setting surface controls | 10 | - Setting convection roast | 26 |
| - Operating the warming zone..... | 11 | - Using the favorites feature..... | 27 |
| - About smoothtop surface | 12 | - Setting the cook & warm feature | 27 |
| - About cookware | 13 | - Setting oven lockout feature..... | 28 |
| SETTING WARMING DRAWER CONTROLS..... | 14 | - Changing hour mode on clock (12hr, 24hr) | 28 |
| INFORMATION..... | 15-16 | - Setting the proof feature..... | 28 |
| - Parts and features | 15 | - To turn on/off the oven light..... | 28 |
| - Control panel features | 16 | SELF-CLEAN..... | 29-30 |
| OPERATION | 17-28 | MAINTENANCE | 31-35 |
| - Setting the clock | 17 | - Removing and replacing the warming drawer | 31 |
| - Setting the timer on/off..... | 17 | - Care & cleaning | 32-34 |
| - Options..... | 18-19 | - Removing & replacing the lift-off oven door | 35 |
| • Setting convection auto conversion feature | | TROUBLESHOOTING | 36-39 |
| • Thermostat adjustment | | - Before calling for service..... | 36-39 |
| • Setting language selection (English or French) | | WARRANTY | 40 |
| • Setting preheating alarm light on/off | | | |
| • Setting beeper volume | | | |
| • Setting temperature unit ("F" or "C") | | | |

SAFETY

IMPORTANT SAFETY INSTRUCTIONS

Read and follow all instructions before using your oven to prevent the risk of fire, electric shock, personal injury, or damage when using the range. This guide do not cover all possible conditions that may occur. Always contact your service agent or manufacturer about problems that you do not understand.



This is the safety alert symbol. This symbol alerts you to potential hazards that can kill or hurt you and others. All safety messages will follow the safety alert symbol and either the word "WARNING" or "CAUTION". These word means :



WARNING

This symbol will alert you to hazards or unsafe practices which could cause serious bodily harm or death.



CAUTION

This symbol will alert you to hazards or unsafe practices which could cause bodily injury or property damage.

- Be certain your appliance is properly installed and grounded by a qualified technician.
- Do not repair or replace any part of the appliance unless specifically recommended in the manual.
- All other servicing should be referred to a qualified technician.
- Always disconnect power to appliance before servicing by unplugged, removing the fuse or switching off the circuit breaker



WARNING



• DO NOT step or sit on the door. Install the Anti-Tip Bracket packed with range.

- The range could be tipped and injury might result from spilled hot liquid, food, or the range itself.

- If the range is pulled away from the wall for cleaning, service, or any other reason, ensure that the Anti-Tip Device is properly reengaged when the range is pushed back against the wall.

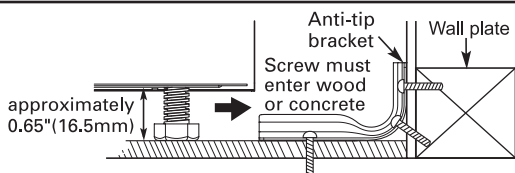

- To reduce the risk of tipping of the range, the range must be secured by properly installing anti-tip devices.
- To check that the anti-tip bracket is properly installed: Grasp the top rear edge of the range back guard and carefully attempt to tilt it forward. Verify that the anti-tip devices are engaged.
- Warming drawer or Storage drawer : Remove drawer and visually inspect that the rear leveling leg is fully inserted into the anti-tip bracket.
- Refer to the installation manual for proper anti-tip bracket installation.

SURFACE COOKING UNITS

- **Use Proper Pan Sizes.** This appliance is equipped with one or more surface units of different size. Select utensils having flat bottoms large enough to cover the surface unit heating element. The use of undersized utensils will expose a portion of the heating element to direct contact and may result in ignition of clothing. Proper relationship of utensil to burner will also improve efficiency.
- **Never Leave Surface Units Unattended at High Heat Settings.** Boilovers cause smoking and greasy spillovers that may ignite.
- **Glazed Cooking Utensils.** Only certain types of glass, glass/ceramic, ceramic, earthenware, or other glazed utensils are suitable for range-top service without breaking due to the sudden change in temperature.
- **Utensil Handles Should Be Turned Inward and Not Extend Over Adjacent Surface Units.** To reduce the risk of burns, ignition of flammable materials, and spillage due to unintentional contact with the utensil, the handle of a utensil should be positioned so that it is turned inward, and does not extend over adjacent surface units.
- Be sure you know which control pads operate each surface unit. Make sure you turned on the correct surface unit.

SAFETY

IMPORTANT SAFETY INSTRUCTIONS

OVEN

- **DO NOT TOUCH HEATING ELEMENTS OR INTERIOR SURFACES OF OVEN.** Heating elements may be hot even though they are dark in color. Interior surfaces of an oven become hot enough to cause burns. During and after use, do not touch or let clothing or other flammable materials contact heating elements or interior surfaces of oven until they have had sufficient time to cool. Other surfaces of the appliance may become hot enough to cause burns. Among these surfaces are the cooktop and areas facing the cooktop, oven vent openings, surfaces near these openings, oven doors, and windows of oven doors.
- **Use Care When Opening Door.** Let hot air or steam escape before you remove or replace food in the oven
- **Do Not Heat Unopened Food Containers.** Build-up of pressure may cause container to burst and result in injury.
- **Protective Liners.** Do not use aluminum foil or any other material to line the oven bottoms. Improper installation of these liners may result in a risk of electric shock or fire.
- **Keep Oven Vent Ducts Unobstructed.** The oven vent is located above the left rear surface unit. This area could become hot during oven use. Never block this vent and never place plastic or heat-sensitive items on vent.
- **Placement of Oven Racks.** Always place oven racks in desired location while oven is cool. If rack must be moved while oven is hot, do not, let a potholder come in contact with the hot heating element in the oven.
- **Do Not** allow aluminum foil or meat probe to contact heating elements.

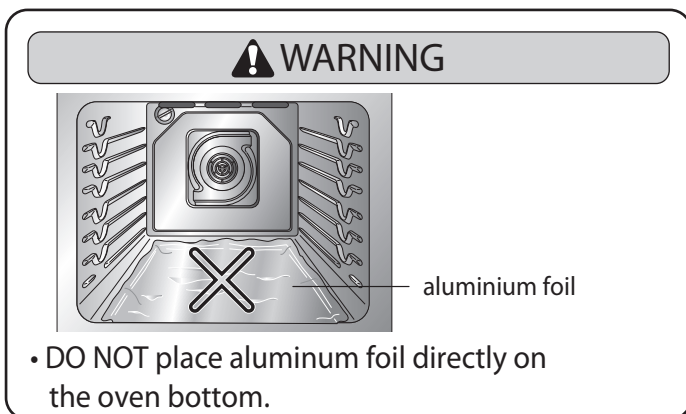

SELF-CLEANING OVENS

- **Do Not Clean Door Gasket.** The door gasket is essential for a good seal. Care should be taken not to rub, damage, or move the gasket.

- **Do Not Use Oven Cleaners.** No commercial oven cleaner or oven liner protective coating of any kind should be used in or around any part of the oven.
- **Clean in the self-clean cycle only parts listed in this manual.** Before self-clean the oven, remove the broiler pan and any utensils of foods from the oven.
- **Before Self-Cleaning the Oven.** Remove broiler pan and other utensils.
- **Never keep pet birds in the kitchen.** The health of birds is extremely sensitive to the fumes released during an oven self-clean cycle. Fumes may be harmful or fatal to birds. Move birds to well-ventilated room.
- **Important Instruction.** In the event the self clean error code F is displayed, or three long beeps sound, the oven is malfunctioning in the self clean mode. Turn off or disconnect appliance from power supply and have serviced by a qualified technician.

VENTILATING HOODS:

- **Clean Ventilating Hoods Frequently.** Grease should not be allowed to accumulate on hood or filter.
- **When flaming foods under the hood, turn the fan on.**

GLASS/CERAMIC COOKING SURFACES

- **DO NOT TOUCH SURFACE UNITS OR AREAS NEAR UNITS.** Surface units may be hot even though they are dark in color. Areas near surface units may become hot enough to cause burns. During and after use, do not touch, or let clothing or other flammable materials contact surface units or areas near units until they have had sufficient time to cool. The areas include – Cooktop, area above the oven door.
- **Do Not Cook on Broken CookTop.** If cooktop should break, cleaning solutions and spillovers may penetrate the broken cook-top and create a risk of electric shock. Contact a qualified technician immediately.
- **Clean CookTop With Caution.** Do not use sponges or cloth to wipe spills on a hot cooking area. Use a proper metal scraper.

DEEP FAT FRYERS:

- Use extreme caution when moving the grease kettle or disposing of hot grease.

SAFETY

IMPORTANT SAFETY INSTRUCTIONS

WARNING

- **DO NOT** step or sit on the door. Install the Anti-Tip Bracket packed with range.
 - The range could be tipped and injury might result from spilled hot liquid, food, or the range itself.
 - If the range is pulled away from the wall for cleaning, service, or any other reason, ensure that the Anti-Tip Device is properly reengaged when the range is pushed back against the wall.
- Turn **POWER OFF** before removing the Warming Drawer.
 - Failure to do so can result in severe personal injury, death or electrical shock.
- Before replacing your oven light bulb, **DISCONNECT** the electrical power to the range at the main fuse or circuit breaker panel.
 - Failure to do so can result in severe personal injury, death or electrical shock.
- Make sure oven and bulb are cool.
- Children should be kept away from the range.
 - Accessible parts may become hot when the grill is in use.

CAUTION

- **DO NOT** store items of interest to children in cabinets above a range or on the back guard of a range.
 - Children climbing on the range to reach items could be seriously injured.
- **DO NOT** use the glass cooktop surface as a cutting board.
- **DO NOT** place or store items that can melt or catch fire on the glass cooktop, even when it is not being used.
- Always turn the surface units on after placing cookware.
- **DO NOT** store heavy items above the cooktop surface that could fall and damage it.
- **DO NOT** place aluminum foil or plastic items such as salt and pepper shakers, spoon holders, or plastic wrappings or any other material on the range when it is in use.
 - The hot air from the vent could melt plastics or ignite flammable items.
- Make sure you turned on the correct surface unit.
- **NEVER** cook directly on the glass. Always use cookware.
- Always place the pan in the center of the surface unit you are cooking on.
- **DO NOT** leave children alone.
 - Children should not be left alone or unattended in area where appliance is in use. Children should never be allowed to sit or stand on any part of the appliance.
- **NEVER** use your appliance for warming or heating the room.
- **DO NOT** use water on grease fires.
 - Turn off the oven to avoid spreading the flames. Smother the fire by closing the oven door or use dry chemical, baking soda, or foam-type extinguishers.
- Use only dry potholders.
 - Moist or damp pot holders on hot surfaces may result in burns from steam. Do not let the pot holder touch hot heating elements. Do not use a towel or other bulky cloth.

SAFETY

IMPORTANT SAFETY INSTRUCTIONS

CAUTION

- Storage in or on appliance.
 - Flammable materials should not be stored in an oven or near surface elements.
- Be certain all packing materials are removed from the appliance before operating.
 - Keep plastics, clothes, and paper away from parts of the appliance that may become hot.
- Wear proper apparel.
 - Loose-fitting or hanging garments should never be worn while using the appliance.
- NEVER leave surface units unattended at high heat setting.
 - Boilovers cause smoking and greasy spillovers that may catch on fire.
- Always turn the surface units off before removing cookware.
- DO NOT use plastic wrap to cover food.
 - Plastic may melt onto the surface and be very difficult to remove.
- DO NOT touch surface units until it has cooled down.
- The surface elements may still be hot and burns may occur if the glass surface is touched before it has cooled down sufficiently.
- Immediately clean the spills on cooking area to prevent a tough cleaning chore later.
- If cabinet storage is provided directly above cooking surface, limit it to items that are infrequently used and can be safely stored in an area subjected to heat. Temperatures may be unsafe for items such as volatile liquids, cleaners or aerosol sprays.
- DO NOT touch surface elements until it has cooled down sufficiently.
 - The surface elements may still be hot and burns may occur.
- NEVER leave food unattended at high or medium-high setting.
 - Boilovers can cause smoking and greasy spillovers may catch on fire.
- Use only cookware and dishes recommended as safe for oven and cooktop use.
- When warming foods do not use containers that seal. Allow venting for heated air to escape.
- DO NOT warm food on the warming zone for more than 2 hours
 - Placing uncooked or cold food on the warming zone could result in foodborne illness.
- Always use pot holders or oven mitts when removing food from the Warming Drawer or Warming Center as cookware and plates will be hot.
 - You can be burned as cookware and plates will be hot.
- Always arrange oven racks when the oven is cool.
- Always turn off all power to the warming before attempting to remove it.

SAFETY

IMPORTANT SAFETY INSTRUCTIONS

CAUTION

- Use caution with the TIMED BAKE or DELAYED TIMED BAKE features. Use the automatic timer when cooking cured or frozen meats and most fruits and vegetables. Foods that can easily spoil, such as milk, eggs, fish, meat or poultry, should be chilled in the refrigerator first. Even when chilled, they should not stand in the oven for more than 1 hour before cooking begins, and should be removed promptly when cooking is completed.
 - Eating spoiled food can result in sickness from food poisoning.
- Should an oven fire occur, leave the oven door closed and turn the oven off. If the fire continues, throw baking soda on the fire or use a fire extinguisher.
- DO NOT put water or flour on the fire.
 - Flour may be explosive and water can cause a grease fire to spread and cause personal injury.
- DO NOT use the roasting rack when boiling.
 - To do so can prevent contacting the broil element and grease splattering.
- DO NOT leave small children unattended near the appliance.
 - During the Self-cleaning cycle, the outside of the range can become very hot to touch.
- DO NOT line the oven walls, racks, bottom or any other part of the range with aluminum foil or any other material.
 - Doing so will destroy heat distribution, produce poor baking results and cause permanent damage to the oven interior (aluminum foil will melt to the interior surface of the oven).
- DO NOT force the door open.
 - This can damage the automatic door locking system. Use care when opening the oven door after the Self-Cleaning cycle. Stand to the side of the oven when opening the door to allow hot air or steam to escape. The oven may still be VERY HOT.
- DO NOT use a steel-wool pad.
 - It will SCRATCH the surface.
- DO NOT use harsh abrasive cleaners or sharp metal scrapers to clean the oven door glass since they can scratch the surface.
 - It may result in shattering of the glass.
- DO NOT use scrub pads or abrasive cleaning pads.
 - They may damage your glass cooktop surface.
- Cookware with rough or bottoms can mark or scratch the cooktop surface.
- Do not slide anything metal or glass across the cooktop.
- Do not use cookware with dirt or dirt build up on bottom.
- Be careful when removing and lifting the door.
- DO NOT lift the door by the handle.
 - The door is very heavy.
- The Oven must be switched off before removing the fan guard for cleaning, the guard must be replaced in accordance with the instructions after cleaning.

SAFETY

Appliance outlets

The 120V appliance outlets located on the control console may be used to run portable appliances placed on countertops beside the range.

The outlets operate independently and are not affected by range control settings.

Note: Do not place portable appliances on the cooktop. Damage to the portable appliance could result if the cooktop is hot.

Appliance Outlet Circuit Breakers:

The circuit breakers for the appliance outlets on your range are located on top of the control console. They are rated for 15 amps, that may trip if the appliance plugged into it exceeds 15 amps. To reset the circuit breaker, press the switch of located on the control console.

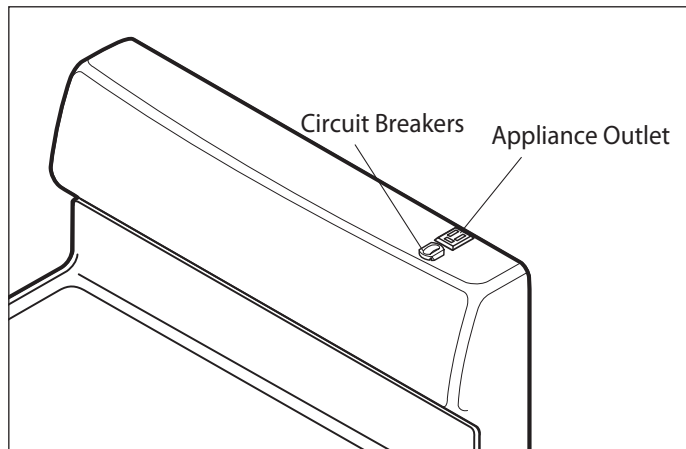

Note: If appliance outlet don't operate, test out your small portable appliance by plugging into other outlets.

SURFACE CONTROLS COOKING

PF MESSAGE

The PF message will appear whenever there has been a power interruption to the appliance. To clear the PF message press ON/OFF control pad to reset and be sure to reset the clock with the correct time of day.

HS(Hot Surface) MESSAGE LIGHT WILL:

- Come on when the unit is hot to touch after it is turned off.
- Come on during Self Cleaning Cycle.
- Stay on even after the unit is turned off.
- Glow until the unit has cooled down to approximately.

LOCATIONS OF THE RADIANT SURFACE ELEMENTS AND CONTROLS

The radiant surface elements are located on the cooktop as below.

The radiant control key locations are same with radiant surface elements on the cooktop.

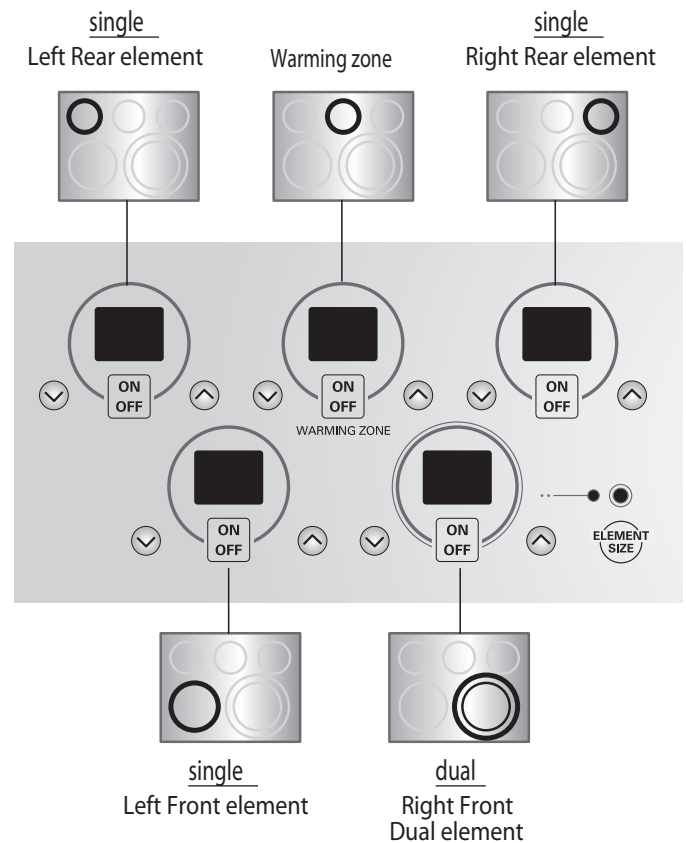

SURFACE CONTROLS COOKING

SETTING SURFACE CONTROLS

When changing from a high heat setting to a lower heat setting, the surface unit may stop glowing. This is normal.

To turn on a single surface unit (Right Rear, Left Rear, Left Front)



1. Press ON/OFF pad for the desired element position. The display will flash "--". (If no further pads are pressed within 10 seconds, the display will disappear.)



2. Press (Hi) pad once to turn on the power level "Hi" or (Lo) pad once for "Lo".



3. Use the (Hi)/(Lo) pad to choose the desired power setting. (Hi)/(Lo) pad is continuously accessible. (Adjustable at any time while the element is ON.)



4. To turn off the unit after cooking, press the ON/OFF pad once.

- Note:**
- Each time a pad is pressed a beep will sound.
 - The power level decreases or increases by **0.5** from **9.0** through **3.0**. (by **0.2** from **3.0** through **1.0**)
 - **Lo** is the lowest power level available.

- Note:** To scroll through the power levels quickly press and hold the (Hi) or (Lo) key pads until the power level desired is reached.

CAUTION

- **DO NOT** touch surface elements until it has cooled down sufficiently.
- The surface elements may still be hot and burns may occur.

CAUTION

- **NEVER** leave food unattended at high or medium-high setting.
- Boilovers can cause smoking and greasy spillovers may catch on fire.

To turn on a dual surface unit (Right Front)

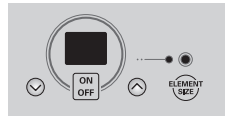

1. Press the ON/OFF pad. The display will flash "--". (If no further pads are pressed within 10 seconds, the display will disappear.)

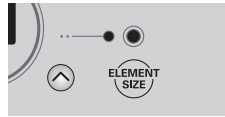

2. Press the ELEMENT SIZE pad as needed to select the desired burner size. Default size is 9". When first selected, 12" size is ON. The light above the ELEMENT SIZE pad indicates which size surface unit is on.



3. Press (Hi) pad once to turn on the power level "Hi" or (Lo) pad once for "Lo".



4. Use the (Hi)/(Lo) pad to choose the desired power setting. (Hi)/(Lo) pad is continuously accessible. (Adjustable at any time while the element is ON.)

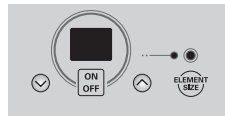

5. To turn off the unit after cooking, press the ON/OFF pad once.

- Note:**
- Each time a pad is pressed a beep will sound.
 - The power level decreases or increases by **0.5** from **9.0** through **3.0**. (by **0.2** from **3.0** through **1.0**)
 - **Lo** is the lowest power level available.

- Note:** To scroll through the power levels quickly press and hold the (Hi) or (Lo) key pads until the power level desired is reached.

CAUTION

- **DO NOT** touch surface elements until it has cooled down sufficiently.
- The surface elements may still be hot and burns may occur.

Recommended Surface Cooking Settings

Recommended setting for the single & dual elements.

| Setting | Type of cooking |
|----------------------------|---|
| HIGH (8.5 – Hi) | Start most foods, bring water to a boil or pan broiling. |
| MEDIUM HIGH (5.5 – 8.0) | Continue a rapid boil, fry or deep fat fry. |
| MEDIUM (3.5 – 5.0) | Maintain a slow boil, thicken sauces and gravies or steam vegetables. |
| MEDIUM LOW (2.2 – 3.0) | Keep foods cooking, poach or stew (2.8 or lower is a simmer setting). |
| LOW/SIMMER (Lo – 2.0) | Keep warm, melt or simmer. |

SURFACE CONTROLS COOKING

OPERATING THE WARMING ZONE

To set the warming zone control



1. Press ON/OFF pad at the warming zone control position. The warming zone indicator light will flash. (If no further pads are pressed within 10 seconds the display will disappear.)



2. Press (↻) once to turn on the power level "Hi" or (↺) to turn on for "Lo."



3. Use the (↻)/(↺) pad to choose the desired power setting. (Adjustable at any time while the element is ON.)



4. To turn off the unit when the food is ready to serve, press the ON/OFF pad once.

- Note:**
- Each time a pad is pressed a beep will sound.
 - The controls for the warming zone allow for 5 different heat settings : **Lo~Hi**
 - **"HS"** will appear when the unit is hot to touch.

⚠ CAUTION

- Use only cookware and dishes recommended as safe for oven and cooktop use.
- Always use oven mitts when removing food from the warming center as cookware and plates will be hot.
- When warming foods do not use containers that seal. Allow venting for heated air to escape.
- DO NOT use plastic wrap to cover foods.
 - Plastic may melt onto the surface and be very difficult to clean.
- Food should be kept in its container and covered with a lid or aluminum foil to maintain food quality.
- DO NOT warm food on the warming zone for more than 2 hours
 - Placing uncooked or cold food on the warming zone could result in foodborne illness.

Suggested Settings

| Setting | Type of cooking | |
|---------|---|--------------------------|
| Lo | Breads/Pastries Casseroles | Gravies Eggs |
| 2 - 4 | Dinner Plate with Food Soups (Cream) Vegetables | Sauces Stews Meats |
| Hi | Fried Foods Soups (Liquid) | Hot Beverages |

SURFACE CONTROLS COOKING

TIPS TO PROTECT THE SMOOTHTOP SURFACE

Cleaning (see page 33~34 for more information)

Before first use, clean the cooktop.

Clean your cooktop daily or after each use. This will keep your cooktop looking good and can prevent damage.

If a spillover occurs while cooking, immediately clean the spill from the cooking area while it is hot to prevent a tough cleaning chore later. Using extreme care, remove spill with a proper metal scraper.

Do not allow spills to remain on the cooking area or the cooktop trim for a long period of time.

Do not use abrasive cleansing powders or scouring pads which will scratch the cooktop.

Do not use chlorine bleach, ammonia or other cleansers not specifically recommended for use on glass-ceramic.

To Prevent Marks & Scratches

Do not use glass pans. They may scratch the surface.

Do not place a trivet or wok ring between the surface and pan. These items can mark or scratches the top.

Do not slide aluminum pans across a hot surface. The pans may leave marks which need to be removed promptly.”
(See Cleaning page 33~34.)

Make sure the surface and the pan bottom are clean and dry before turning on to prevent scratches.

To prevent scratching or damaging to the glass-ceramic top, do not leave sugar, salt or fats on the cooking area. Wipe the cooktop surface with a clean cloth or paper towel before using.

Do not slide heavy metal pans across the surface since these may scratch.

To Prevent Stains

Do not use a soiled dish cloth or sponge to clean the cooktop surface. A film will remain which may cause stains on the cooking surface after the area is heated.

Continuously cooking on a soiled surface may/will result in a permanent stain.

To Prevent Other Damages

Do not allow plastic, sugar or foods with high sugar content to melt onto the hot cooktop. Should this happen, clean immediately. (See Cleaning page 33~34.)

Do not let a pan boil dry as this will damage the surface and pan.

Do not use cooktop as a work surface or cutting board.

Do not cook food directly on the surface.

SMOOTHTOP SURFACE

Smoothtop Surface Notes:

- **Cooktop may emit light smoke and odor** the first few times the cooktop is used. This is normal.
- **Smoothtop cooktops retain heat for a period of time after the element is turned off.** Turn the elements off a few minutes before food is completely cooked and use the retained heat to complete cooking. When the hot surface light turns off, the cooking area will cool down enough to touch. Because of the way they retain heat, the smoothtop elements will not respond to changes in settings as quickly as coil elements.
- In the event of a potential boilover, remove the pan from the cooking surface.
- **Do not attempt to lift the cooktop.**
- The smoothtop surface may appear discolored when it is hot. This is normal and will disappear when the surface cools.

COOKING AREAS

The cooking areas on your range are identified by permanent circles on the smoothtop surface. For the most efficient cooking, fit the pan size to the element size.

Pans should not extend more than 1/2 to 1-inch beyond the cooking area.

When a control is turned on, a glow can be seen through the smoothtop surface. **The element will cycle on and off to maintain the preset heat setting, even on Hi.**

For more information on cookware, refer to Cookware Recommendations.

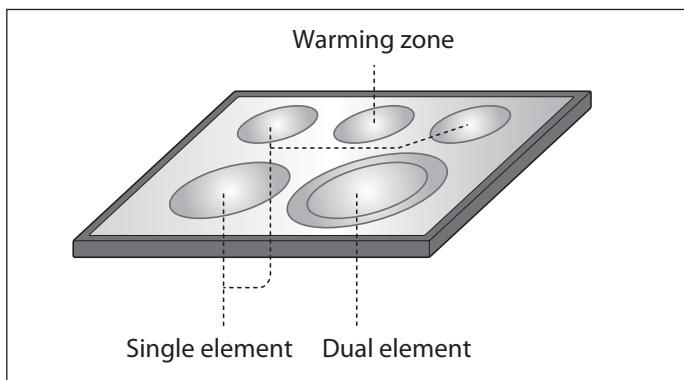

SURFACE CONTROLS COOKING

USING THE PROPER COOKWARE

Using the right cookware can prevent many problems, such as food taking longer to cook or achieving inconsistent results. Proper pans will reduce cooking times and cook food more evenly. Stainless steel is recommended.

Check pans for flat bottoms by using a straight edge or ruler

1. Place a ruler across the bottom of the pan.
2. Hold it up to the light.
3. Little or no light should be visible under the ruler.

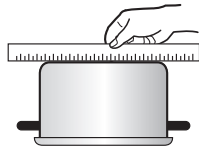

HOME CANNING TIPS

Be sure the canner is centered over the surface unit. And Make sure the canner is flat on the bottom.

The base must not be more than 1 inch larger than the element. Use of water bath canners with rippled bottoms may extend the time required to bring the water to a boil and cooktops may be damaged.

Some canners are designed with smaller bases for use on smooth top surfaces.

Use the high heat setting only until the water comes to a boil or pressure is reached in the canner.

Reduce to the lowest heat setting that maintains the boil or pressure. If the heat is not turned down, the cooktop may be damaged.

| Recommended | Incorrect |
|--|---|
| Flat bottom and straight sides. | Curved, grooved, or warped pan bottoms. Pans with uneven bottoms do not cook efficiently and sometimes may not boil liquid. |
| Heavy-gauge pans. | Very thin-gauge metal or glass pans. |
| Pan sizes match the amount of food to be prepared and the size of the surface element. | Pans are smaller or larger than the element. |
| Weight of handle does not tilt pan. Pan is well balanced. | Cookware with loose or broken handles. Heavy handles that tilt the pan. |
| Tight-fitting lids. | Loose-fitting lids. |
| Flat bottom woks. | Woks with a ring-stand bottom. |

- Note:**
- Do not use a small pan on a large element. Not only does this waste energy, but it can also result in spillovers burning onto the cooking area which requires extra cleaning.
 - Do not use non-flat specialty items that are oversized or uneven such as round bottom woks, rippled bottom and/or oversized canners and griddles.
 - Do not use foil or foil-type containers. Foil may melt onto the glass. If metal melts on the cooktop, do not use. Call an authorized Service agent.

SETTING WARMING DRAWER CONTROLS

ARRANGING WARMING DRAWER RACK POSITIONS

The rack can be used in 2 ways:

- In the **upright position** to allow low profile food items to be placed both under and on top of the rack (for example, rolls or biscuits on top of the rack and a casserole dish underneath).
 - In the **downward position** to allow you to place light weight food items and empty cookware (for example, rolls or pastries and dinner plates) on the rack.
- Set the Warming Drawer rack in either position as shown below (Fig. 1).

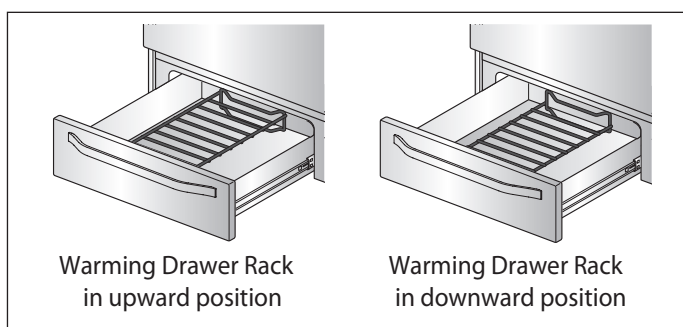

CAUTION

- Always use pot holders or oven mitts when removing food from the Warming Drawer.
- You can be burned as cookware and plates will be hot.

To Operate the Warming Drawer

The purpose of the Warming Drawer is to keep hot cooked foods at serving temperature. Always start with hot food. It is not recommended to heat cold food in the Warming Drawer.

All food placed in the Warming Drawer should be covered with a lid or aluminum foil to maintain quality. Do not use plastic wrap to cover food. Plastic may melt onto the drawer and be very difficult to clean. Use only utensils and cookware recommended for oven use in the Warming Drawer.

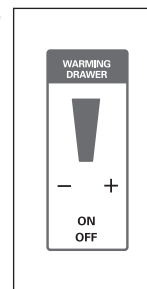

Warming Drawer Control

To set the warming drawer control





1. Press ON/OFF at the WARMING DRAWER position. The indicator light will flash. (If no further pads are pressed within 25 seconds, the display will clear.)
2. Press (+) once to turn on the power level for high(5 level) or (-) for Low(1 level).
3. Use (-)/(+) to choose the desired power setting. (Adjustable at any time while the Drawer is ON.)
4. When the food is ready for removal, press ON/OFF once to turn off.

Note: • The Warming Drawer will shut off automatically after 3 hours.

SETTING WARMING DRAWER CONTROLS

Warming Drawer Recommended Food Setting Table

| Setting | Type of food |
|---|---|
| Low  | <ul style="list-style-type: none"> • Rolls (soft) • Empty dinner plates |
| Medium  | <ul style="list-style-type: none"> • Gravies • Eggs • Biscuits • Pastries • Roasts (Beef, Pork, Lamb) • Casseroles • Vegetables • Rolls(hard) |
| High  | <ul style="list-style-type: none"> • Bacon • Poultry • Pizza • Hamburger patties • Pork chops • Fried Foods |

Different types of food may be placed in the warming drawer at the same time. For best results, do not hold foods longer than 1 hour. For smaller quantities or heat-sensitive foods, such as eggs, do not hold longer than 30 minutes.

The maximum operating time is 3 hours.

Warming Drawer Operation

- 1. Do not use the warming drawer for storage of racks, broiler pans, insert pans, plates, or utensils.** The warming drawer contains a heating element which may damage any items not specifically designed to be used with it and should only be used to store cookware specifically supplied by LG with your range.
- 2. Do not put food or foil directly on the surface or base of the warming drawer.** This may result in damage to your drawer and may spoil your food.
- 3. Do not place plastic wrap in the warming drawer or use it to cover food being heated in the warming drawer.** Plastic may melt onto the drawer or surrounding areas and is very difficult to remove. Use only aluminum foil or cookware that is capable of withstanding baking temperature to heat or cover your food.
- 4. Do not use the warming drawer to heat water or any other liquids.** Spilled liquids may cause an electrical short or result in severe personal injury, electric shock or death.
- 5. Never place plastics, paper, canned foods or other combustible material into the warming drawer.** These items pose a severe risk of fire, damage and injury.
- 6. In the unlikely event that an item falls behind the warming drawer, always turn the power off and wait for the warming drawer to cool before retrieving the item.** Never attempt to retrieve any items that fall behind the warming drawer without first turning the power off and ensuring the warming drawer cavity has cooled off. Failure to do so may result in severe personal injury, electric shock or death.

INFORMATION

PARTS AND FEATURES

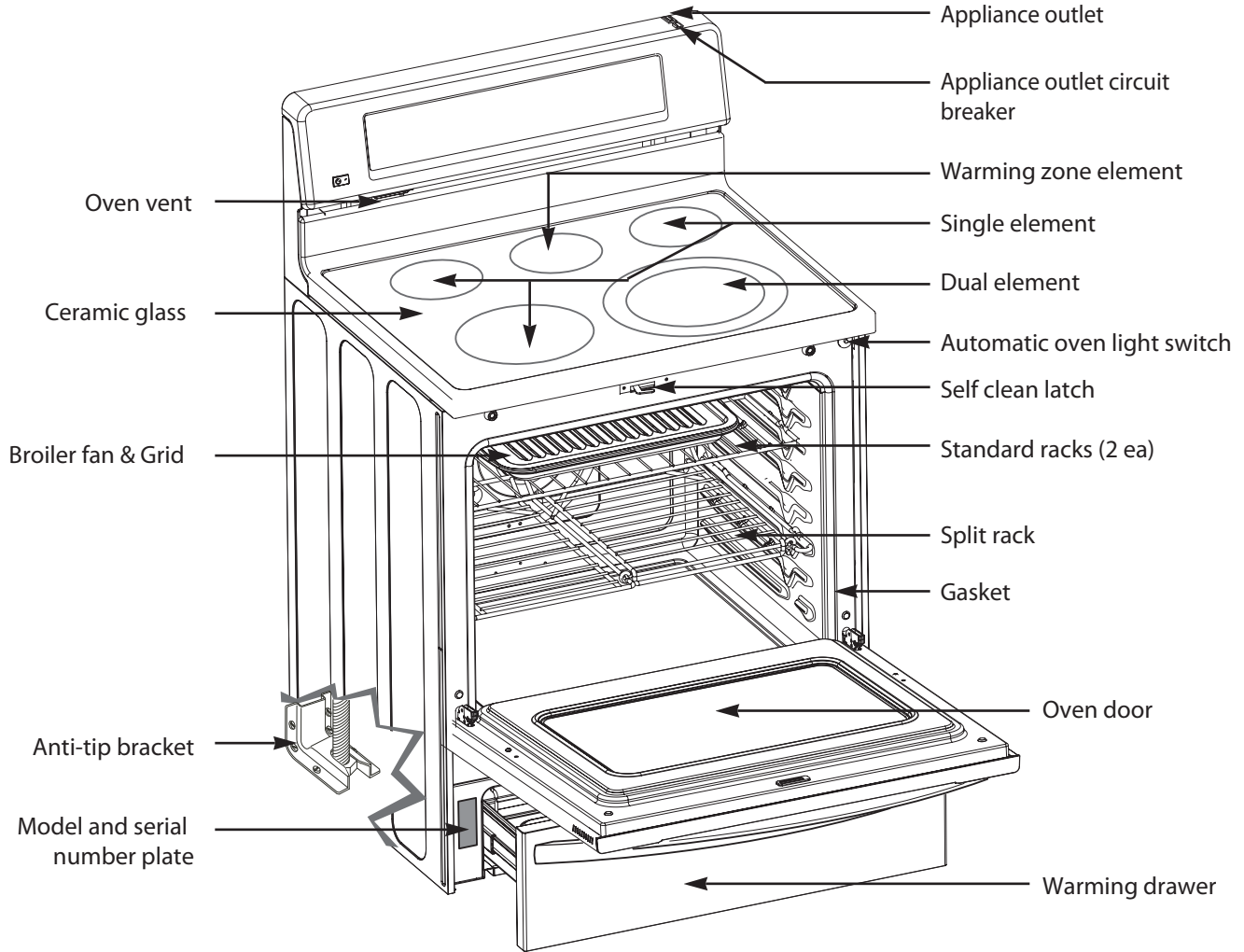

Common use

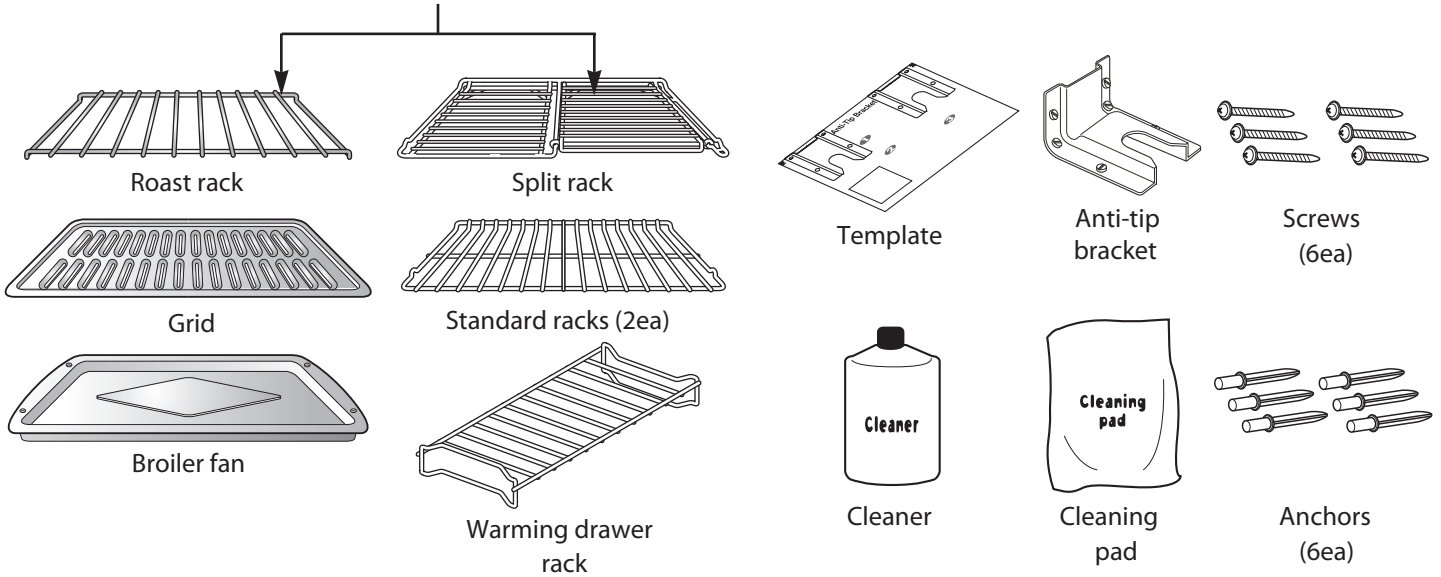

CONTROL PANEL FEATURES

READ THE INSTRUCTIONS CAREFULLY BEFORE USING THE OVEN. For satisfactory use of your oven, become familiar with the various features and functions of the oven as described below. **Detailed instructions for each feature and function follow later in this Owner's manual.**

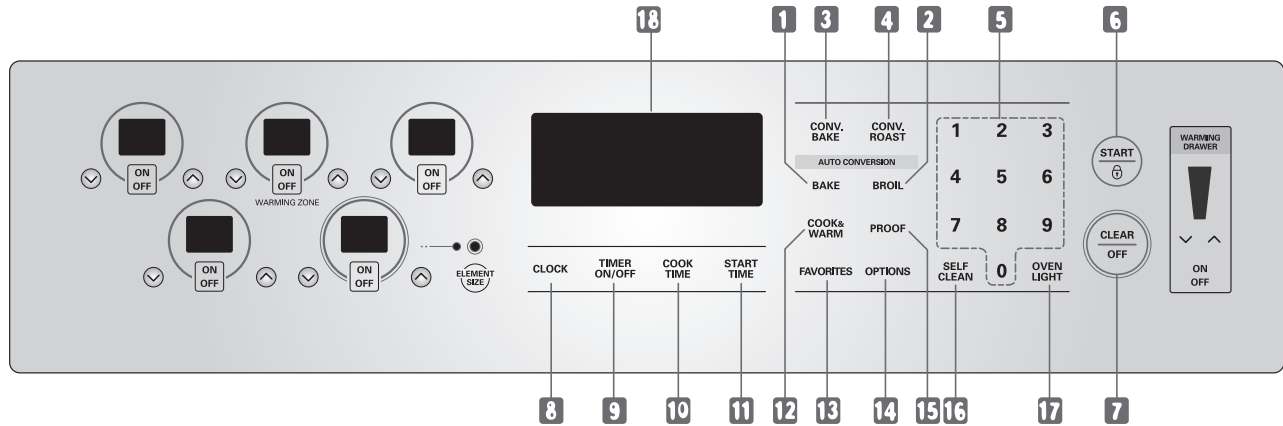

- 1** BAKE PAD: Press to select the bake function.
- 2** BROIL PAD: Press to select the broil function.
- 3** CONVECTION BAKE PAD: Press to select baking with the convection function.
- 4** CONVECTION ROAST PAD: Press to select roasting with the convection function.
- 5** NUMBER PADS: Use to set any function requiring numbers such as the time of day on the clock, the timer, the oven temperature, the start time and length of operation for timed baking.
- 6** START PAD: Must be pressed to start any cooking or cleaning function.
- 7** CLEAR/OFF PAD: Press to cancel all oven operations except the clock and timer.
- 8** CLOCK PAD: Press before setting the time of day.
- 9** TIMER ON/OFF PAD: Press to select the timer feature.
- 10** COOK TIME PAD: Press and then use the number pads to set the amount of time you want your food to cook. The oven will shut off when the cooking time has run out.
- 11** START TIME PAD: Use along with BAKE, CONV. BAKE, CONV. ROAST, COOK TIME and SELF CLEAN pads to set the oven to start and stop automatically at a time you set.
- 12** COOK & WARM PAD: Press to keep cooked foods warm. See the how to set the oven for warming section.
- 13** FAVORITES PAD: Press to set favorite cooking.
- 14** OPTIONS PAD: Press to set 7 types of option category.
- 15** PROOF PAD: Press to select a warm environment useful for rising yeast-leavened products.
- 16** SELF CLEAN PAD: Press to select self-cleaning function. See the using the Self-Clean Oven section.
- 17** OVEN LIGHT PAD: Press to turn the oven light on or off.
- 18** DISPLAY: Shows the time of day, oven temperature, whether the oven is in the bake, broil or self-cleaning mode and the times set for the timer or automatic oven operations.

Note: If “F– and a number” appear in the display and the oven control signals, this indicates a function error code. Press the **CLEAR/OFF** pad. Allow the oven to cool for one hour. Put the oven back into operation. If the function error code repeats, disconnect the power to the oven and call for service. **If your oven was set for a timed oven operation and a power outage occurred, the clock and all programmed functions must be reset. The time of day will flash and PF will appear in the display when there has been a power outage.**

OPERATION

SETTING THE CLOCK

The **CLOCK** pad is used to set the clock. The clock has been preset at the factory for 12 hours operation. When the range is first plugged in, or when the power supply to the range has been interrupted, the timer in the display will show with power failure "PF". You can make a choice between 12-hour clock and 24-hour clock (refer to the page 28):

To set the clock (example below for 1:30):

1. Press CLEAR/OFF pad.

2. Press CLOCK pad.

3. Press 1, 3, 0 pads to set the time of day to 1:30.

4. Press START pad. The clock will start.

MINIMUM & MAXIMUM CONTROL PAD SETTINGS

All of the features listed have minimum and maximum time or temperature settings that may be entered into the control. An entry acceptance beep will sound each time a control pad is pressed.

An entry error tone (3 short beeps) will sound if the entry of the temperature or time is below the minimum or above the maximum settings for the feature.

| FEATURE | MIN. TEMP. /TIME | MAX. TEMP. /TIME |
|--------------------------------------|-----------------------|------------------|
| BAKE TEMP. | 170°F / 75°C | 550°F / 285°C |
| BROIL TEMP. | LO(400°F) | HI(550°F) |
| SELF CLEAN TIME | 2 hours | 4 hours |
| CONVECTION BAKE/ CONVECTION ROAST | 300°F / 150°C | 550°F / 285°C |
| COOK & WARM | 170°F(75°C) / 3 hours | |
| RADIANT ELEMENT | Default: 12 Hr. | |
| WARMING ZONE | Default: 2 Hr. | |
| WARMING DRAWER | Default: 3 Hr. | |
| PROOF | Default: 12 Hr. | |

SETTING THE TIMER ON/OFF

The **TIMER ON/OFF** serves as an extra timer in the kitchen that will beep when the set time has run out. It does not start or stop cooking. The **TIMER ON/OFF** feature can be used during any of the other oven control functions.

To set the Timer (example for 5 minutes):

TIMER ON/OFF

1 2 3
4 5 6
7 8 9
0

TIMER ON/OFF

TIMER ON/OFF

1. Press **TIMER ON/OFF** pad twice. "0:00" and "HR" inside "O" will appear and "TIMER" will flash in the display.
2. Press the number pads to set the desired time in the display (press "5" pad). If you make a mistake press the **TIMER ON/OFF** pad and begin again.
3. Press **TIMER ON/OFF** pad. The time will count down with "5:00" and "TIMER" will show in the display.

Note: If **TIMER ON/OFF** is not pressed the timer will return to the time of day.
4. When the set time has run out, "End" will show in the display. The clock will sound with 3 beeps every 15 seconds until **TIMER ON/OFF** pad is pressed.

Note: If the remaining time is not in the display, recall the remaining time by pressing the **TIMER ON/OFF**.

Note:

1. If you press **TIMER ON/OFF** pad once, it allows you to make a "second" unit of timer setting. (for example: if you press "5" and "6", it means 56 seconds)
2. If you press **TIMER ON/OFF** pad twice, it allows you to make a "minute" unit of timer setting. (for example: if you press "5" and "6", it means 56 minutes)

To cancel the Timer before the set time has run out:

TIMER ON/OFF

1. Press **TIMER ON/OFF** pad once. The display will return to the time of day.

OPERATION (OPTIONS)

SETTING CONVECTION AUTO CONVERSION FEATURE

When using convection bake, the Convection Auto Conversion feature will automatically convert entered regular baking temperatures to convection baking temperatures.

This feature is activated so that the display will show the actual converted (reduced) temperature. For example, if you enter a regular recipe temperature of 350° F and press the **START** pad, the display will show the converted temperature of 325° F.

To set the feature Disable/enable

OPTIONS

1. Press the OPTIONS pad once.

1 2

2. Press "1" pad for ENABLE or "2" pad for DISABLE.



3. Press **START** pad to accept the desired change.

THERMOSTAT ADJUSTMENT

The temperature in the oven has been preset at the factory. When first using the oven, be sure to follow recipe times and temperatures. If you think the oven is too hot or too cool, the temperature in the oven can be adjusted. Before adjusting, test a recipe by using a temperature setting that is higher or lower than the recommended temperature. The baking results should help you to decide how much of an adjustment is needed.

The oven temperature can be adjusted from -35 °F (-19° C) to 35° F (19° C) .

Note: The thermostat adjustments made with this feature will just change Bake, Convection Bake and Convection Roast temperature.

To increase the oven temperature:

OPTIONS

1. Press OPTIONS pad twice.

2 0

2. To increase the temperature use the number pads to enter the desired change.
(Example 20°F : 2, 0).
"20" will be displayed.



3. Press **START** to accept the temperature change and the display will return to the time of day. Press **CLEAR/OFF** to reject the change if necessary.



To decrease the oven temperature:

OPTIONS

1. Press OPTIONS pad twice.

2 0

OPTIONS

2. To decrease the temperature use the number pads to enter the desired change.
(Example -20°F : 2, 0) and then press **OPTIONS** pad once.
"20" will be displayed.



3. Press **START** to accept the temperature change and the display will return to the time of day. Press **CLEAR/OFF** to reject the change if necessary.



OPERATION (OPTIONS)

SETTING LANGUAGE SELECTION (English or French)

The scroll display can be shown either ENGLISH or FRENCH.

To set language option

- | | |
|---|---|
| OPTIONS | 1. Press the OPTIONS pad 3 times. |
| 1 2 | 2. Press "1" pad for ENGLISH or "2" pad for FRENCH. |
|  | 3. Press START pad to accept the change. |

SETTING PREHEATING ALARM LIGHT ON/OFF

The interior oven light automatically turn on when the oven door is opened.

When oven reaches set-temperature after preheat, the oven notifies preheat-end by flashing oven lamp until door is opened.

You can activate or deactivate smart oven light feature. Default Setting is on.

To set smart oven light on/off

- | | |
|---|---|
| OPTIONS | 1. Press the OPTIONS pad 4 times. |
| 1 2 | 2. Press "1" pad for ON or "2" pad for OFF. |
|  | 3. Press START pad to accept the change. |

SETTING BEEPER VOLUME

The beeper volume feature allows you to adjust the volumes to a more acceptable volume. There are four possible volume levels.

To set beeper volume

- | | |
|---|--|
| OPTIONS | 1. Press OPTIONS pad 5 times. |
| 1 2 3 | 2. Press "1" pad for loud level, "2" pad for normal level, "3" pad for low level and "4" pad for mute level. |
|  | 3. Press START pad. |

SETTING TEMPERATURE UNIT — Fahrenheit or Centigrade

OPTIONS pad control the Fahrenheit or Centigrade temperature display modes. The oven control can be programmed to display temperatures in Fahrenheit or Centigrade. The oven has been preset at the factory to display in Fahrenheit.

To change display from Fahrenheit to Centigrade or Centigrade to Fahrenheit:

- | | |
|---|---|
| OPTIONS | 1. Press OPTIONS pad 6 times. |
| 1 2 | 2. Press "1" number pad for Fahrenheit(°F) or "2" pad for Centigrade(°C). |
|  | 3. Press START pad to accept the desired change. |

OPERATION

SETTING BAKE

The **BAKE** pad controls normal baking. The oven can be programmed to bake at any temperature from 170°F to 550°F. Default temperature is 350°F (175°C).

To set the Bake Temperature to 375°F:



1. Press BAKE pad. "350°" will appear in the display.
2. Press 3, 7, 5. "BAKE" will flash.
3. Press START pad. The display will show "BAKE" and the changing temperature starting at 100°F.

Important Note:

Place food in the oven after preheating if the recipe calls for it. Preheating is so important for good results when baking cakes, cookies, pastry and breads. After the oven has reached the desired temperature, long beeps will sound 5 times and oven lamp will flash. Preheating will take approximately 10~15 minutes.

Press **CLEAR/OFF** to cancel the Bake feature at any time.

To change the Bake Temperature while cooking (example changing from 375° to 425°F):

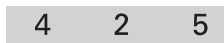

1. If the oven temperature needs to be changed to 425°F, press BAKE pad and "350°" will show in the display.
2. Press 4, 2, 5. pads.
3. Press START pad.

OPERATION

BAKING LAYER CAKES

Baking results will be better if baking pans are centered in the oven as much as possible. If baking with more than one pan, place the pans so each has at least 1" to 1½" of air space around it.

If cooking on multiple racks, place the oven racks in positions B and D (for 2 racks). Place in positions B, D and F (for 3 racks). Place the cookware as shown in Fig. 1, 2.

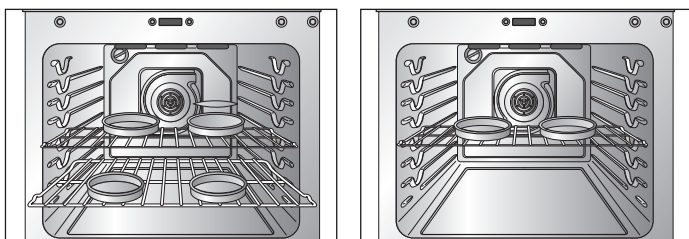
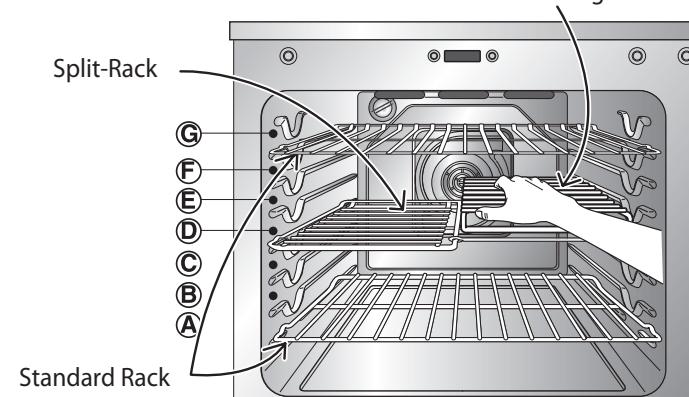

Fig.1

Fig.2

Common use with Roasting rack



• The oven has 7 rack positions..

| Type of Food | Rack Position |
|---|---------------|
| Angel food cake, Frozen pies | B |
| Bundt or pound cakes | C |
| Biscuits, muffins, brownies, cookies, cupcakes, layer cakes, pies | D |
| Casseroles | D |
| Turkey, roast or ham | A |

BEFORE USING OVEN RACKS

The oven has three racks (2 standard racks, 1 split rack). The racks have stops to be placed correctly on the supports, those will stop before coming completely out.

SPLIT RACK

The right side of the split rack can be removed to accommodate a large roaster on the lower rack.

- The removable section of the Split Rack can be used as a roasting rack in the broiling pan.
- Be careful when removing cooked food from the split rack to avoid burns.

To remove racks:

1. Pull the rack straight out until it stops.
2. Lift up the front of the rack and pull it out.

To replace racks.

1. Place the end of the rack on the support.
2. Tilt the front end up and push the rack in.

CAUTION

- DO NOT cover a rack with aluminum foil or any other material or place on the oven bottom.
- This will result in poor baking by disturbing heat circulation and may damage the oven bottom.
- Always arrange oven racks when the oven is cool.

OPERATION

SETTING TIMED BAKE

The oven will turn on immediately and cook for a selected length of time. At the end of the cooking time, the oven will turn off automatically.

To program the oven to begin baking immediately and to shut off automatically:
(example below to bake at 300°F for 30 minutes):

BAKE

3 0 0

COOK TIME

3 0

1. Be sure the clock is set for the correct time of day.
2. Press BAKE pad, "350°" will appear in the display.
3. Press 3, 0, 0 pads. "BAKE" will flash and "300°" will appear in the display.
4. Press COOK TIME pad. "TIMED" will flash. "BAKE", "0:00" and "300°" will appear in the display.
5. Enter the desired baking time by pressing 3, 0 pads. "TIMED" will flash and "BAKE", "30:00" and "300°" will appear in the display.

Note: Baking time can be set for any amount of time between 1 minute to 11 hours and 59 minutes.

START

6. Press START pad. The oven will turn on, and the display will show the cooking time countdown and the changing temperature starting at 100°F (the temperature display will start to change once the oven temperature reaches 100°F). The oven will continue to cook for the set amount of time, then turn off automatically, unless the COOK & WARM feature was set. Refer to the "Setting the COOK & WARM feature" section on page 27.

When the Timed Bake finishes:

1. "END OF CYCLE" and the time of day will show in the display. The oven will shut off automatically.
2. The control will continue to beep 3 times every 1 minute until CLEAR/OFF pad is pressed.



CAUTION

- Use caution with the TIMED BAKE or DELAYED TIMED BAKE features. Use the automatic timer when cooking cured or frozen meats and most fruits and vegetables. Foods that can easily spoil, such as milk, eggs, fish, meat or poultry, should be chilled in the refrigerator first. Even when chilled, they should not stand in the oven for more than 1 hour before cooking begins, and should be removed promptly when cooking is completed.
 - Eating spoiled food can result in sickness from food poisoning.

Important Note:

Place food in the oven after preheating if the recipe calls for it. Preheating is so important for good results when baking cakes, cookies, pastry and breads. After the oven has reached the desired temperature, long beeps will sound 5 times and oven lamp will flash. Preheating will take approximately 10~15 minutes.

OPERATION

SETTING DELAYED TIMED BAKE

The **BAKE**, **COOK TIME** and **START TIME** pads control the Delayed Timed Bake feature. The automatic timer of the Delayed Timed Bake will turn the oven ON and OFF at the time you select in advance.

To program the oven for a Delay Start and to shut off automatically (example for baking at 300°F for 30 minutes and starting at 4:30):

1. Be sure that the clock is set with the correct time of day.
2. Arrange interior oven rack(s) and place the food in the oven.
3. Press **BAKE** pad. "350°" will appear in the display.
4. Press 3, 0, 0 pads. "BAKE" will flash and "300°" will appear in the display.
5. Press **COOK TIME** pad. "TIMED" will flash; "BAKE", "0:00" and "300°" will appear in the display.

Note: If you want to change cook time, repeat step 5, 6 and press **START** pad.

6. Enter the desired baking time using the number pads by pressing 3, 0 pads. "TIMED" will flash; "BAKE", "30:00" and "300°" will appear in the display.

Note: Baking time can be set for any amount of time from 1 minute to 11 hours and 59 minutes.

7. Press **START TIME** pad. Enter the desired start time using the number pads 4, 3, 0.

8. Press **START** pad. At the set time, a short beep will sound. The oven will begin to Bake. When the oven has reached the desired temperature, a long beep will sound 5 times and oven lamp will flash. The display will show "300°" and "BAKE".

Note: Press **CLEAR/OFF** to cancel the Delayed Timed Bake feature at any time.

When the set bake time runs out:

1. "END OF CYCLE" and the time of day will show in the display. The oven will shut off automatically.
2. The unit will continue to beep 3 times every 1 minute until **CLEAR/OFF** pad is pressed.



SETTING BROIL

Always operate broil mode with door closed. "Hi" is used for most broiling. Use "Lo" broil when broiling longer cooking foods. The lower temperature allows food to cook to the well done stage without excessive browning. For best results when broiling, use a pan designed for broiling.

To set the oven to broil at the Hi or Lo setting:

1. Place the meat or fish on the broiler grid in the broiler pan.
2. Follow suggested rack positions in the Broiling Guide.
3. Press **BROIL** pad once for "Hi" broil or twice for "Lo" broil. Use "Lo" to cook foods such as poultry or thick cuts of meat thoroughly without over-browning them.
4. Press **START** pad. The oven will begin to broil.
5. Broil on one side until food is browned; turn and cook on the other side.

Note: Always pull the rack out to the stop position before turning or removing food.

BROIL



6. To cancel broiling or if finished broiling press **CLEAR/OFF** pad.

CAUTION

- Should an oven fire occur, leave the oven door closed and turn the oven off. If the fire continues, throw baking soda on the fire or use a fire extinguisher.
- **DO NOT** put water or flour on the fire.
 - Flour may be explosive and water can cause a grease fire to spread and cause personal injury.

OPERATION

RECOMMENDED BROILING GUIDE

The size, weight, thickness, starting temperature and your preference of doneness will affect broiling times. This guide is based on meats at refrigerator temperature.

For best results when broiling, use a pan designed for broiling (refer to the Fig. 1)

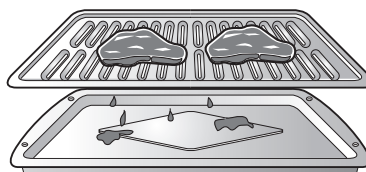
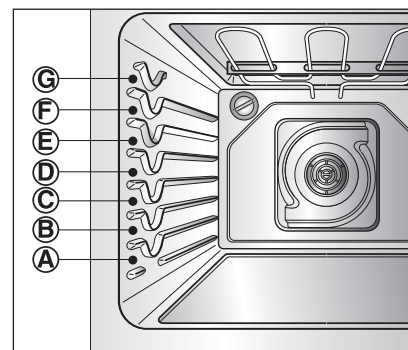

Fig.1



ENGLISH

| Food | Quantity and/or Thickness | Shelf Position | First Side Time (min.) | Second Side Time (min.) | Comments |
|--|---|----------------|------------------------|-------------------------|---|
| Ground Beef Well Done | 1 lb. (4 patties) 1/2 to 3/4" thick | F or G | 7-9 | 3-5 | Space evenly. Up to 8 patties take about the same time. |
| Beef Steaks Rare Medium Well Done | 1" thick 1 to 1 1/2 lbs. | F F F | 6 7 8 | 2-3 2-3 3-4 | Steaks less than 1" thick cook through before browning. Pan frying is recommended. Slash fat. |
| Rare Medium Well Done | 1 1/2" thick 2 to 2 1/2 lbs. | D D D | 10 12 14 | 4-6 6-8 8-10 | |
| Chicken | 1 whole cut up 2 to 2 1/2 lbs., split lengthwise 2 Breasts | C C | 20 20 | 6-8 6-10 | Broil skin-side-down first. |
| Lobster Tails | 2-4 10 to 12 oz. each | C | 12-14 | Do not turn over. | Cut through back of shell. Spread open. Brush with melted butter before broiling and after half of broiling time. |
| Fish Fillets | 1/4 to 1/2" thick | E | 5 | 3-4 | Handle and turn very carefully. Brush with lemon butter before and during cooking, if desired. |
| Ham Slices (precooked) | 1/2" thick | D | 5 | 3-5 | Increase time 5 to 10 minutes per side for 1 1/2" thick or home-cured ham. |
| Pork Chops Well Done | 2 (1/2" thick) 2 (1" thick) about 1 lb. | E D | 7 9-10 | 6-8 7-9 | Slash fat. |
| Lamb Chops Medium Well Done | 2 (1" thick) about 10 to 12 oz. | E E | 6 8 | 4-6 7-9 | Slash fat. |
| Medium Well Done | 2 (1 1/2" thick) about 1 lb. | E E | 11 13 | 9 9-11 | |
| Salmon Steaks | 2 (1" thick) 4 (1" thick) about 1 lb. | D D | 8 9 | 3-4 4-6 | Grease pan. Brush steaks with melted butter. |

OPERATION

SETTING CONVECTION BAKE

Benefits of Convection Bake:

1. Some foods cook up to 25 to 30% faster, saving time and energy.
2. Multiple rack baking.
3. No special pans or bakeware needed.

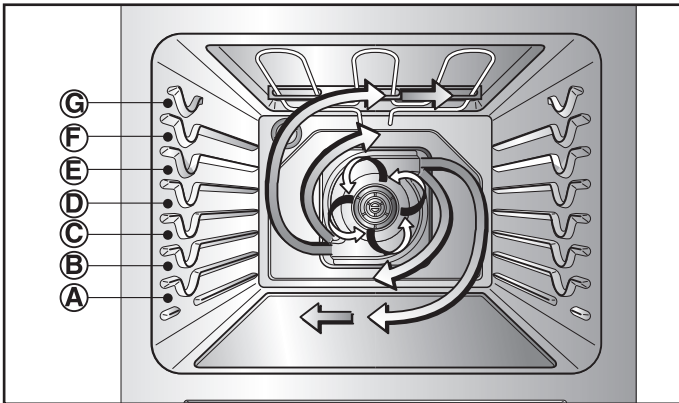

The **CONV. BAKE** pad controls the Convection Bake feature. Use the Convection Bake feature when cooking speed is desired. The oven can be programmed for Convection Bake at any temperature between 300°F (150°C) to 550°F (285°C).

Convection baking uses a fan to circulate the oven's heat evenly and continuously within the oven. This improved heat distribution allows for even cooking and excellent results using multiple racks at the same time. Foods cooked on a single oven rack will generally cook faster and more evenly with Convection Bake. Multiple oven rack cooking may slightly increase cook times for some foods, but the overall result is time saved. Breads and pastries brown more evenly.

Tips for Convection Bake

- Time reductions will vary depending on the amount and type of food to be cooked. Cookies and biscuits should be baked on pans with no sides or very low sides to allow heated air to circulate around the food. Food baked on pans with a dark finish will cook faster.
- When using Convection Bake with a single rack, place oven rack in position D. If cooking on multiple racks, place the oven racks in positions B and D (for 2 racks). Place in positions B, D and F (for 3 racks).
- Cakes have **better** results when baked using the **BAKE** pad (you can still use multiple racks when baking multiple cake layers at the same time).
- Cookies, muffins, biscuits and other quickbreads give very good results when using multiple racks.

Note: The convection fan can stop during a convection bake cycle to allow for more even heating. This is not a failure of the range and should be considered normal operation.

To set the oven for Convection Bake and temperature to 375°F:



1. Press **CONV. BAKE** pad. "CONV BAKE" will flash and "350°" will appear in the display.
2. Press 3, 7, 5 pads.
3. Press **START** pad. The display will show "CONV BAKE" and the changing temperature starting at 100°F. A beep will sound 3 times when the adjusted oven temperature (for this example it is 350°F) is reached and the display will show auto-converted oven temperature "350°", "CONV BAKE" and the fan icon.

Press **CLEAR/OFF** to cancel Convection Bake at any time.

SETTING CONVECTION ROAST

The **CONV. ROAST** pad is designed to give optimum cooking performance for this feature. The Convection Roast pad combines a cook cycle with the convection fan and element to roast meats and poultry. Preheating is not necessary for meats and poultry. Heated air circulates around the food from all sides, sealing in juices and flavors. Foods are crispy brown on the outside while staying moist on the inside.

- Convection Roast is especially good for large tender cuts of meat, uncovered.

To set the Convection Roast feature (example for Meats to cook at 375°F):

**CONV.
ROAST**

3 7 5

START
⏻

1. Arrange interior oven racks and place food in oven.
2. Press CONV. ROAST pad. "CONV ROAST" will flash and "350°" will be displayed.
3. Press 3, 7, 5 pads.
4. Press START pad. The display will show "CONV ROAST" and the changing temperature starting at 100°F. A beep will sound 3 times when the adjusted oven temperature (for this example it is 350°F) is reached and the display will show auto-converted oven temperature "350°", "CONV ROAST" and the fan icon.

Press to **CLEAR/OFF** pad to stop this made at any time.

Roasting Rack Instructions

When preparing meats for convection roasting, use the broiler pan and grid along with the roasting rack. The broiler pan will catch grease spills and the grid will help prevent grease splatters. The roasting rack will allow the heat to circulate around the meat.

CAUTION

- **DO NOT** use the roasting rack when broiling.
 - To prevent food from coming in contact with the broil element and grease from splattering.

1. Place oven rack on bottom or next to the bottom rack position.
2. Place the grid in the broiler pan. The roasting rack fits on the grid allowing the heated air to circulate under the food for even cooking and helps to increase browning on the underside. Make sure the roasting rack is securely seated on the grid in the broiler pan. **DO NOT** use the broiler pan without the grid. **DO NOT** cover the grid with aluminum foil.
3. Position food (fat side up) on the roasting rack.
4. Place the broiler pan on the oven rack.



Roasting rack
(Right side of the split rack)



Grid

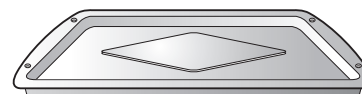

Broiler Pan

OPERATION

USING THE FAVORITES FEATURE

The **FAVORITES** pad is used to record and recall your favorite recipe settings. This feature may store and recall from 1 to 3 different settings. The Favorite Setting feature may be used with **COOK TIME** feature. This feature will not work with any other function including **START TIME** feature.

To set FAVORITES feature

1. Place the food in the oven.
2. Press FAVORITES pad once for Bread, twice for Meat and 3 times for Chicken. Default temperature will appear and COOK will flash.

FAVORITES

| Category | How to select | Default Temp. (may be changed and recall) | Operating mode |
|------------|------------------------------|---|------------------|
| 1. Bread | Press FAVORITES pad once. | 375°F | BAKE |
| 2. Meat | Press FAVORITES pad twice. | 325°F | Convection Roast |
| 3. Chicken | Press FAVORITES pad 3 times. | 350°F | Convection Roast |

3. Press the number pads to set the desired oven temperature within 25 seconds. This temperature will be stored and be recalled from next times.
4. Press the START pad. A long beep will sound 3 times when the temperature reaches to selected temperature.



Note: Only the temperature you selected will be stored, and not the cooking time.

SETTING THE COOK & WARM FEATURE

The **COOK & WARM** feature will maintain an oven temperature of 170°F. This feature is not desired to reheat cold foods. The Cook & Warm feature will keep cooked food warm for serving up to 3 hours after cooking has finished. After 3 hours the **COOK & WARM** feature will shut the oven OFF automatically. The Cook & Warm feature may be used without any other cooking operations or can be used after cooking has finished using **TIMED BAKE (CONV. BAKE, CONV. ROAST)** or **DELAYED TIMED BAKE (CONV. BAKE, CONV. ROAST)**.

To set Cook & Warm:

COOK & WARM

1. Press COOK & WARM pad.



2. Press START pad.



3. To turn Cook & Warm OFF, press CLEAR/OFF pad at any time.

To set Cook & Warm feature after timed cooking

1. Set the cooking feature that you want to use: TIMED (BAKE, CONV. BAKE, CONV. ROAST), DELAY TIMED (BAKE, CONV. BAKE, CONV. ROAST) refer to the relevant previous page.
2. Press START pad.
3. Press COOK & WARM pad. COOK & WARM mode is set to turn on automatically after completing the TIMED COOKING or DELAY TIMED COOKING.
4. To turn Cook & Warm off at any time press CLEAR/OFF.



COOK & WARM



Note: Do not use plastic containers, lids or plastic wrap. Cover them with an oven-safe lid or aluminum foil.

SETTING OVEN & COOKTOP LOCKOUT FEATURE

The **START** pad control the Oven & Cooktop Lockout Feature. The Oven & Cooktop Lockout feature automatically Locks the oven door and prevent the Warming drawer, cooktop elements and most oven controls from being turned ON. It does not disable the clock, timer or the interior oven Light.

To activate the Oven Lockout feature:



1. Press and hold **START** for 3 seconds.
2. 2 beeps will sound, **LOCKING** will appear & "DOOR LOCKED" will flash in the display. Once the oven door is locked the "DOOR LOCKED" indicator will stop flashing and remain on along with the lock icon (🔒) light.

To reactivate normal oven operation:



1. Press and hold **START** for 3 seconds. A beep will sound 2 times. The "DOOR LOCKED" will continue to flash until the oven door has completely unlocked and the lock icon (🔒) light will clear.
2. The oven is again fully operational.

CHANGING HOUR MODE ON CLOCK (12HR,24 HR)

Your control is set to use a 12-hour clock. If you would prefer to have a 24-hour time clock, follow the steps below.

Changing between 12 or 24 hour time of day

CLOCK

1 2



1. Press and hold **CLOCK** pad for 3 seconds.
2. Press "1" pad for 12-hour, "2" pad for 24-hour.
3. Press **START** pad to accept the desired change.

SETTING THE PROOF FEATURE

The proof feature maintains a warm environment useful for rising yeast-leavened products.

How to Set the Oven For Proofing

1. Place the covered dough in a dish in the oven on shelf B or C.

Note: For best results, cover the dough with a cloth or with plastic wrap.

PROOF



2. Press the **PROOF** pad and then the **START** pad. The proof feature automatically provides the optimum temperature for the proof process, and therefore does not have a temperature adjustment.



3. When proofing is finished, press the **CLEAR/OFF** pad.

To avoid lowering the oven temperature and lengthening proofing time, do not open the oven door unnecessarily.

Check bread products early to avoid over-proofing.

Note: • Do not use the proofing mode for warming food or keeping food hot. The proofing oven temperature is not hot enough to hold foods at safe temperatures. Use the **COOK & WARM** feature to keep food warm.

- Proofing will not operate when oven is above 125°F. "Oven is Hot" will show in the display.

TO TURN ON/OFF THE OVEN LIGHT

OVEN LIGHT

The oven light automatically turns ON when the door is opened. The oven light may also be manually turned ON or OFF by pressing the **OVEN LIGHT** pad.

Note: The oven light cannot be turned on if self-clean feature is active.

SELF-CLEAN

The self-clean cycle uses above normal cooking temperatures to automatically clean the oven interior.

It is normal for flare-ups, smoking, or flaming to occur during cleaning if the oven is heavily soiled. It is better to clean the oven regularly rather than to wait until there is a heavy build-up of soil in the oven.

During the cleaning process, the kitchen should be well ventilated to get rid of normal odors associated with cleaning.

CAUTION

- **DO NOT** leave small children unattended near the appliance.
 - During the Self-cleaning cycle, the outside of the range can become very hot to touch.
- **Move Birds to another well-ventilated room.**
 - The health of some birds is extremely sensitive to the fumes given off during the Self-Cleaning cycle of any range.
- **DO NOT** line the oven walls, racks, bottom or any other part of the range with aluminum foil or any other material.
 - Doing so will destroy heat distribution, produce poor baking results and cause permanent damage to the oven interior (aluminum foil will melt to the interior surface of the oven).
- **DO NOT** force the door open.
 - This can damage the automatic door locking system. Use care when opening the oven door after the Self-Cleaning cycle. Stand to the side of the oven when opening the door to allow hot air or steam to escape. The oven may still be VERY HOT.

Before a Self Clean Cycle

We recommend venting your kitchen with an open window or using a ventilation fan or hood during the first self-clean cycle.

Remove the oven racks, broiler pan, broiler grid, all cookware and aluminum foil or any other material from the oven.

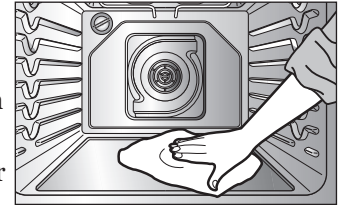

Wipe up heavy soil on the oven bottom.

Note:

Remove silver-colored oven racks before you begin the self-clean cycle.

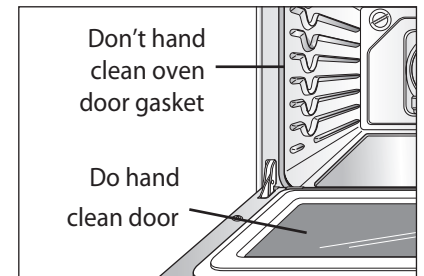

- The silver-colored oven racks can be self-cleaned, but they will darken, lose their luster and become hard to slide. It is recommended to remove all racks before starting the self clean cycle.
- Soil on the front frame of the range and outside the gasket on the door will need to be cleaned by hand. Clean these areas with hot water, soap-filled steel-wool pads or cleansers such as Soft Scrub. Rinse well with clean water and dry.
- Do not clean the gasket. The fiberglass material of the oven door gasket cannot withstand abrasion. It is essential for the gasket to remain intact. If you notice it becoming worn or frayed, replace it.
- Wipe up any heavy spillovers on the oven bottom.
- Make sure the oven light bulb cover is in place and the oven light is off.
- Do not leave baking/ pizza stone in the oven during Self-Clean cycle.

SELF-CLEAN

The **SELF-CLEAN** pad is used to start a Self-Clean cycle. When used with **START TIME** pad, a delayed Self-Clean cycle may also be programmed. The Self-Clean function has cycle times of 2, 3, or 4 hours.

To start an immediate Self-Clean cycle and shut off automatically

**SELF
CLEAN**



1. Be sure the clock is set with the correct time of day, the oven is empty and the oven door is closed.
2. Touch SELF CLEAN once for a 3-hour clean time or twice for a 2-hour clean time or 3 times for 4-hour clean time. A 3-hour self-clean time is recommended for use when cleaning small, contained spills. A self clean time of 4 hours is recommended for heavily soiled ovens.
3. Touch START. The DOOR LOCKED icon will flash.
4. Once the SELF CLEAN is set, the oven door will lock automatically. You will not be able to open the oven door until the oven is cooled. The lock will release automatically.

During the Self-Clean cycle

- You may see some smoke and smell an odor the first few times the oven is cleaned. This is normal and will lessen in time. Smoke may also occur if the oven is heavily soiled or if a broiler pan was left in the oven.
- As the oven heats, you may hear sounds of metal parts expanding and contracting. This is normal and will not damage the oven.
- Do not force the oven door open when LOCK is displayed. The oven door will remain locked until the oven temperature has cooled. Forcing the door open will damage the door.

To set a delay start time of 8:00 o'clock

**SELF
CLEAN**

**START
TIME**

8 0 0



1. Touch SELF CLEAN. Select the desired self clean time by touching SELF CLEAN.
2. Touch START TIME. Enter the desired Self-Clean starting time using the number 8, 0, and 0.
3. Touch START. DELAY and CLEAN will remain on.
4. Self-Cleaning cycle will turn on automatically at the set time.

Note: • The warming drawer cannot be used during the self clean cycle.

Stopping or Interrupting a Self-Clean cycle:

If it becomes necessary to stop or interrupt a Self-Cleaning cycle due to excessive smoke or fire in the oven:



1. Touch CLEAR/OFF.
2. After the oven has cooled down, the DOOR LOCK will automatically release allowing you to open the oven door.

Note: When using the Self-Clean feature:

- A Self--Clean cycle cannot be started if **Oven Lockout** feature is active.
- Once the SELF CLEAN is set, the oven door will lock automatically. You will not be able to open the oven door until the oven is cooled. The lock will release automatically.
- Once the door has been locked the “DOOR” “LOCKED” indicator light will stop flashing and remain on. Allow about 15 seconds for the oven door lock to close.
- If your clock is set for normal 12 hours display mode the Delayed Self-Clean can never be set to start more than 12 hours in advance. To set for a delayed Self-Clean cycle 12- 24 hours in advance see page 32 for instructions to set the control for the 24 hours time of day display mode.

When the self-clean cycle is done

- It will not be possible to open the oven door until oven temperature has cooled.
- It is recommend to use 2 hour self-clean cycle for light soil, 3 hours cycle for average soil, and 4 hours cycle for heavy soil.
- Additional time is needed to cool the oven down. Therefore, the oven door will not release from the lock position until after it has cooled.

Note: • HS (Hot Surface) will display on the cooktop during the Self Clean cycle.

After the Self-Clean cycle

- You may notice some white ash in the oven. Wipe it off with a damp cloth or a soapfilled steel wool pad after the oven cools. These deposits are usually a salt residue that cannot be removed by the clean cycle. If the oven is not clean after one clean cycle, repeat the cycle.
- If oven racks were left in the oven and do not slide smoothly after a clean cycle, wipe racks and rack supports with a small amount of vegetable oil to make them glide easier.
- Fine lines may appear in the porcelain because it went through heating and cooling. This is normal and will not affect performance.

MAINTENANCE

REMOVING & REPLACING THE WARMING DRAWER

To Remove Warming Drawer:

1. CAUTION - Turn power OFF before removing the Warming Drawer.
2. Open the drawer to the fully opened position.
3. Remove the 2 screws (right and left side). (refer to below picture)
4. Locate glide lever on each side of drawer, push down on the left glide lever and pull up on the right glide lever.
5. Pull the Warming Drawer away from the range.

! WARNING

- Turn POWER OFF before removing the Warming Drawer.
- Failure to do so can result in severe personal injury, death or electrical shock.

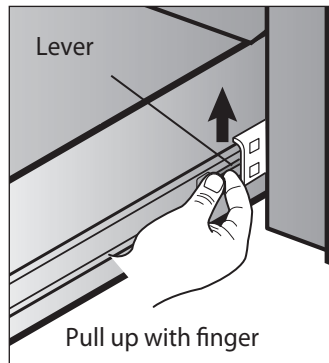
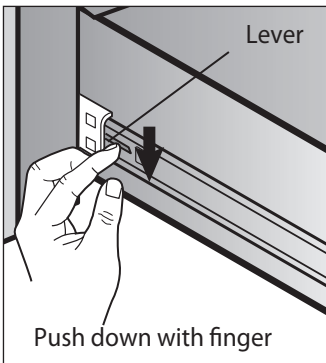
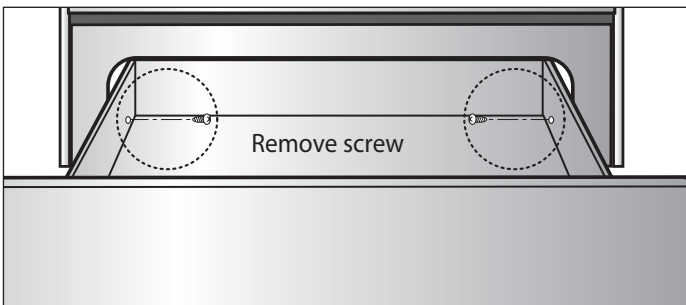

To Replace the Warming Drawer:

1. Replace shield on the right glide of the drawer body.
2. Pull the bearing glides to the front of the chassis glide.
3. Align the glide on each side of the drawer with the glide slots on the range.
4. Push the drawer into the range until levers "click" (approximately 2 inch). Pull the drawer open again to seat bearing glides into position. If you do not hear the levers "click" or the bearing glides do not feel seated remove the drawer and repeat steps 2-4.
This will minimize possible damage to the bearing glides.

OVEN VENT

The oven vent is located above the left rear surface unit. This area could become hot during oven use.

It is normal for steam to come out of the vent.

The vent is important for proper air circulation. Never block this vent.

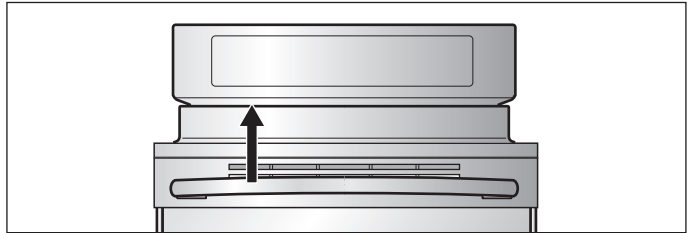

CARE & CLEANING

Changing the Oven Light

The oven light is a standard 40-watt appliance bulb. It will come on when the oven door is open. When the oven door is closed, press LIGHT to turn it on or off. It will not work during the Self-Clean cycle.

To replace:

1. Unplug range or disconnect power.
2. Turn the glass bulb cover in the back of the oven counterclockwise to remove.
3. Turn bulb counterclockwise to remove from socket.
4. Replace bulb and bulb cover by turning clockwise.
5. Plug in range or reconnect power.

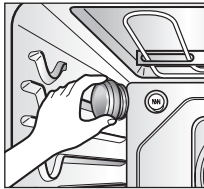

WARNING

- Before replacing your oven light bulb, **DISCONNECT** the electrical power to the range at the main fuse or circuit breaker panel.
 - Failure to do so can result in severe personal injury, death or electrical shock.
- Make sure oven and bulb are cool.

WARNING



- **DO NOT** step or sit on the door. Install the Anti-Tip Bracket packed with range.
 - The range could be tipped and injury might result from spilled hot liquid, food, or the range itself.
 - If the range is pulled away from the wall for cleaning, service, or any other reason, ensure that the Anti-Tip Device is properly reengaged when the range is pushed back against the wall.

Painted and Body Parts, and Decorative Trim

For general cleaning, use a cloth with hot and soapy water. For more difficult soils and built-up grease, apply a liquid detergent directly onto the soil. Leave on soil for 30 to 60 minutes. Rinse with a damp cloth and dry. **DO NOT** use abrasive cleaners on any of these materials; they can scratch.

Stainless Steel Surfaces (on some models)

Do not use a steel-wool pad; it will scratch the surface.

1. Shake bottle well.
2. Place a small amount of Stainless Steel Appliance Cleaner or polish on a damp cloth or damp paper towel.
3. Clean a small area, rubbing with the grain of the stainless steel if applicable.
4. Dry and buff with a clean, dry paper towel or soft cloth.
5. Repeat as necessary.

Note: If a mineral oil-based stainless steel appliance cleaner has been used before to clean the appliance, wash the surface with dishwashing liquid and water prior to using the Stainless Steel Appliance Cleaner or polish.

Broiler Pan and Grid

Do not clean the broiler pan or grid in a self-cleaning mode.

After broiling, remove the broiler pan from the oven. Remove the grid from the pan. Carefully pour out the grease from the pan into a proper container.

Wash and rinse the broiler pan and grid in hot water with a soap-filled or plastic scouring pad.

If food has burned on, sprinkle the grid with cleaner while hot and cover with wet paper towels or a dishcloth. Soaking the pan will remove burned-on foods.

Both the broiler pan and grid may be cleaned with a commercial oven cleaner.

Both the broiler pan and grid can also be cleaned in a dishwasher.

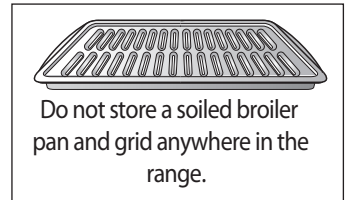

Oven Racks

Remove the oven racks before the Self-Clean cycle for cleaning. If left, clean by using a mild, abrasive cleaner. Rinse with clean water and dry.

If the racks are cleaned in the Self-Clean cycle, their color will turn slightly blue and the finish will be dull. After the Self-Clean cycle is complete, and the oven has cooled, rub the sides of the racks with wax paper or a cloth containing a small amount of oil (this will make the racks glide easier into the rack tracks).

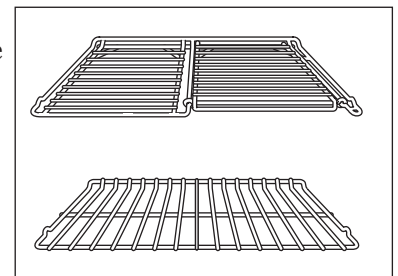

MAINTENANCE

Oven door

Use soap & water to thoroughly clean the top, sides and front of the oven door. Rinse well. You may use a glass cleaner on the outside glass of the oven door. **DO NOT** immerse the door in water. **DO NOT spray or allow water or the glass cleaner to enter the door vents.** DO NOT use oven cleaners, cleaning powders or any harsh abrasive cleaning materials on the outside of the oven door.

DO NOT clean the oven door gasket. The oven door gasket is made of a woven material, on Self-Cleaning models, which is essential for a good seal. Care should be taken not to rub, damage or remove this gasket.

CAUTION

- **DO NOT** use harsh abrasive cleaners or sharp metal scrapers to clean the oven door glass since they can scratch the surface.
- It may result in shattering of the glass.

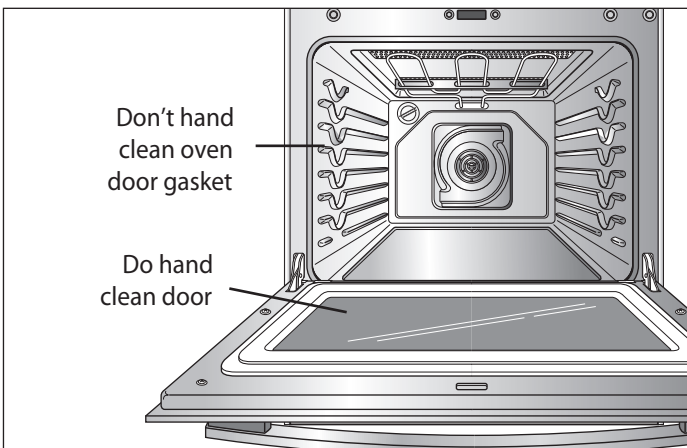

CLEANING THE GLASS COOKTOP

Normal Daily Use Cleaning

Use **ONLY** the Ceramic Cooktop Cleaner or cooktop cleaner included with your range, on the glass cooktop. Other creams may not be as effective or they might damage the surface with scratches or permanent staining.

To maintain and protect the surface of your glass cooktop, follow these steps:

1. Before using the cooktop for the first time, clean it with Ceramic Cooktop Cleaner or included cleaner. This helps protect the top and makes cleanup easier.
2. Daily use of Ceramic Cooktop Cleaner or included cleaner will help keep the cooktop looking new.
3. Shake the cleaning cream well. Apply a few drops of Cleaner directly to the cooktop.
4. Use a paper towel clean the entire cooktop surface.
5. Rinse with clear water and use a dry cloth or paper towel to remove all cleaning residue.

Note: DO NOT heat the cooktop until it has been cleaned thoroughly.

CAUTION

- **DO NOT** use scrub pads or abrasive cleaning pads.
- They may damage your glass cooktop surface.
- For your safety please wear an oven mitt potholder while cleaning the hot cooking surface.

MAINTENANCE

Burned-On Residue

To clean the glass-ceramic

Step. 1

First remove any burnt-on deposits or spilled food from your glass-ceramic cooking surface with a suitable metal razor scraper (similar to scraping paint off of your windowpanes in your home - it will not damage the decorated cooking surface). Hold the scraper at approximately a 30° angle to the cooktop.

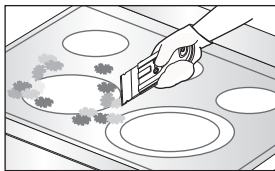

Note: Do not use a dull or nicked blade. For your safety, please wear an oven mitt potholder while using the metal scraper.

Step. 2

When the cooking surface has cooled down apply a few dabs (about the size of a dime) of an approved cleaner in each burner area and work the cleaning cream over the cooktop surface with a damp paper towel as if you were cleaning a window.

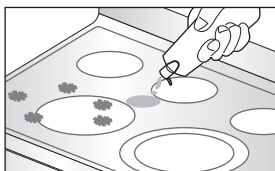

Note: Approved cleaner

- Weiman CookTop Cleaning Cream** (www.weiman.com)
- Cerama Bryte** (www.ceramabryte.com)
- Hope's Cooktop Cleaning Cream** (www.camden-industrial.com)
- Easy-Off 3 in 1 Glass Top Cleaner Spray** (www.easyoff.us).

Step. 3

As a final step, clean with clear water and wipe the cooktop surface with a clean, dry paper towel.



Important: If any sugar or food containing sugar (preserves, ketchup, tomato sauce, jellies, fudge, candy, syrups, chocolate, etc.), a plastic item or kitchen foil accidentally melts on the hot surface of your cooktop, remove the molten material IMMEDIATELY with a metal razor scraper (it will not damage the decorated cooking surface) while the cooking surface is still hot to avoid the risk of damage to the glass-ceramic surface. For your safety please wear an oven mitt potholder while cleaning the hot cooking surface.

Metal Marks and Scratches

1. Be careful not to slide pots and pans across your cooktop. It will leave metal markings on the cooktop surface. These marks are removable using the Ceramic Cooktop Cleaner or included cleaner with the Cleaning Pad for Ceramic Cooktops.
2. If pots with a thin overlay of aluminum or copper are allowed to boil dry, the overlay may leave black discoloration on the cooktop. This should be removed immediately before heating again or the discoloration may be permanent.

CAUTION

- Cookware with rough or uneven bottoms can mark or scratch the cooktop surface.
- Do not slide metal or glass across the cooktop surface.
- Do not use cookware with any dirt build up on bottom.

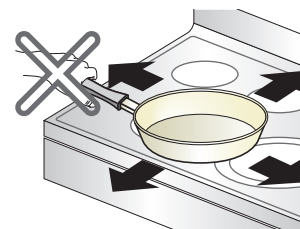

Cooktop Seal

To clean the cooktop seal around the edges of the glass, lay a wet cloth on it for a few minutes, then wipe clean with nonabrasive cleaners.



MAINTENANCE

REMOVING & REPLACING THE LIFT-OFF OVEN DOOR

CAUTION

- Be careful when removing and lifting the door.
- DO NOT lift the door by the handle.
 - The door is very heavy.

To remove the door:

Step. 1
Fully open the door.

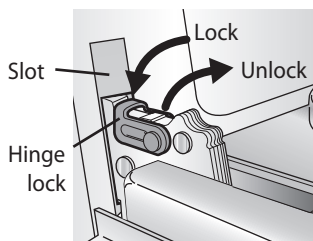

<Fig.1>

Step. 2
Pull the hinge locks down toward (Fig.1) the door frame, to the unlocked position.

Step. 3
Firmly grasp both sides of the door at the top.

Step. 4
Close door to the door removal position, which is approximately 5 degrees.
(refer to the Fig.2)

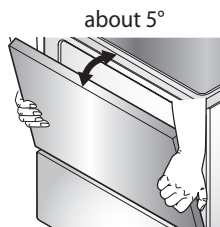

<Fig.2>

Step. 5
Lift door up and out until the hinge arm is clear of the slot.

To replace the door:

Step. 1
Firmly grasp both sides of the door at the top.

Step. 2
With the door at the same angle as the removal position, seat the indentation of the hinge arm into the bottom edge of the hinge slot. The notch in the hinge arm must be fully seated into the bottom of the slot.

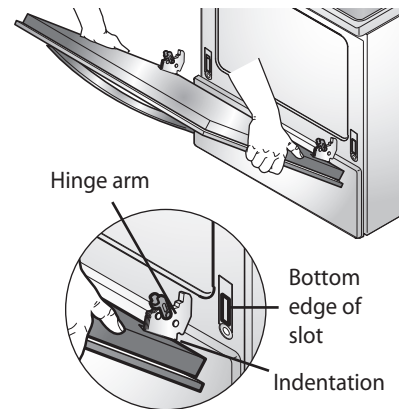

Step. 3
Fully open the door. If the door will not fully open, the indentation is not seated correctly in the bottom edge of the slot.

Step. 4
Push the hinge locks up against the front frame of the oven cavity to the locked position.

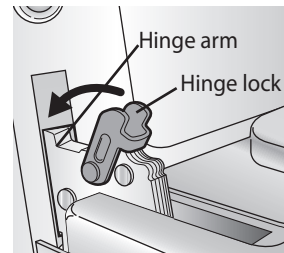

Step. 5
Close the oven door.

DOOR CARE INSTRUCTIONS

- Most oven doors contain glass that can break..

Read the following recommendations:

1. Do not close the oven door until all the oven racks are fully in place.
2. Do not hit the glass with pots, pans, or any other object.
3. Scratching, hitting, jarring or stressing the glass may weaken its structure causing an increased risk of breakage at a later time.

TROUBLESHOOTING

BEFORE CALLING FOR SERVICE

Before you call for service, review this list. It may save you time and expense. The list includes common occurrences that are not the result of defective workmanship or materials in this appliance.

| Problem | Possible cause / Solution | | | | | | | | | | | | | | |
|--|--|------|-------|-----|-------------------|-----|-----------------------------------|-----|-----------------------|-----|------------------------|-----|------------|-----|-----------------|
| Range is not level. | <ul style="list-style-type: none"> • Poor installation. Place oven rack in center of oven. Place a level on the oven rack. Adjust leveling legs at base of range until the oven rack is level. • Be sure floor is level and is strong and stable enough to adequately support range. • If floor is sagging or sloping, contact a carpenter to correct the situation. • Kitchen cabinet alignment may make range appear unlevel. Be sure cabinets are square and have sufficient room for range clearance. | | | | | | | | | | | | | | |
| Cannot move appliance easily. Appliance must be accessible for service. | <ul style="list-style-type: none"> • Cabinets not square or are built in too tightly. Contact builder or installer to make appliance accessible. • Carpet interferes with range. Provide sufficient space so range can be lifted over carpet. | | | | | | | | | | | | | | |
| Oven control beeps and displays any F code error. | <ul style="list-style-type: none"> • Electronic control has detected a fault condition. Press CLEAR/OFF to clear the display and stop beeping. Reprogram oven. If fault recurs, record fault number. Press CLEAR/OFF and contact a Service agent. <table border="1" style="margin-left: 20px; border-collapse: collapse;"> <thead> <tr> <th style="text-align: center;">CODE</th> <th style="text-align: center;">CAUSE</th> </tr> </thead> <tbody> <tr> <td style="text-align: center;">F-1</td> <td>Keypad is shorted</td> </tr> <tr> <td style="text-align: center;">F-2</td> <td>Door locking system don't operate</td> </tr> <tr> <td style="text-align: center;">F-3</td> <td>Oven sensor is opened</td> </tr> <tr> <td style="text-align: center;">F-4</td> <td>Oven sensor is shorted</td> </tr> <tr> <td style="text-align: center;">F-7</td> <td>No heating</td> </tr> <tr> <td style="text-align: center;">F-9</td> <td>Oven is too hot</td> </tr> </tbody> </table> | CODE | CAUSE | F-1 | Keypad is shorted | F-2 | Door locking system don't operate | F-3 | Oven sensor is opened | F-4 | Oven sensor is shorted | F-7 | No heating | F-9 | Oven is too hot |
| CODE | CAUSE | | | | | | | | | | | | | | |
| F-1 | Keypad is shorted | | | | | | | | | | | | | | |
| F-2 | Door locking system don't operate | | | | | | | | | | | | | | |
| F-3 | Oven sensor is opened | | | | | | | | | | | | | | |
| F-4 | Oven sensor is shorted | | | | | | | | | | | | | | |
| F-7 | No heating | | | | | | | | | | | | | | |
| F-9 | Oven is too hot | | | | | | | | | | | | | | |
| Surface units will not maintain a rolling boil or cooking is not fast enough | <ul style="list-style-type: none"> • Improper cookware being used. <ul style="list-style-type: none"> - Use pans which are flat and match the diameter of the surface unit selected. • In some areas, the power (voltage) may be low. <ul style="list-style-type: none"> - Cover pan with a lid until desired heat is obtained. | | | | | | | | | | | | | | |
| Surface units do not work properly | <ul style="list-style-type: none"> • A fuse in your home may be blown or the circuit breaker tripped. <ul style="list-style-type: none"> - Replace the fuse or reset the circuit breaker. • Cooktop controls improperly set. <ul style="list-style-type: none"> - Check to see the correct control is set for the surface unit you are using. | | | | | | | | | | | | | | |
| Surface unit stops glowing when changed to a lower setting | <ul style="list-style-type: none"> • This is normal..the unit is still on and hot. | | | | | | | | | | | | | | |
| Areas of discoloration on the cooktop | <ul style="list-style-type: none"> • Food spillovers not cleaned before next use. <ul style="list-style-type: none"> - See the Cleaning the glass cooktop section. • Hot surface on a model with a light-colored cooktop. <ul style="list-style-type: none"> - This is normal. The surface may appear discolored when it is hot. This is temporary and will disappear as the glass cools. | | | | | | | | | | | | | | |
| Automatically cycling on and off of surface units | <ul style="list-style-type: none"> • This is normal. <ul style="list-style-type: none"> - The element will cycle on and off to maintain the heat setting. | | | | | | | | | | | | | | |

TROUBLESHOOTING

| Problem | Possible cause / Solution |
|---|--|
| Oven will not work | <ul style="list-style-type: none"> • Plug on range is not completely inserted in the electrical outlet. <ul style="list-style-type: none"> - Make sure electrical plug is plugged into a live, properly grounded outlet. • A fuse in your home may be blown or the circuit breaker tripped. <ul style="list-style-type: none"> - Replace the fuse or reset the circuit breaker. • Oven controls improperly set. <ul style="list-style-type: none"> - See the Using the oven section. • Oven too hot. <ul style="list-style-type: none"> - Allow the oven to cool to below locking temperature. |
| Appliance does not operate. | <ul style="list-style-type: none"> • Make sure cord is plugged correctly into outlet. Check circuit breakers. • Service wiring is not complete. Contact your appliance Servicer for assistance. • Power outage. Check house lights to be sure. Call your local electric company for service. |
| Oven control displays "PF", "HS" message. | <ul style="list-style-type: none"> • The PF message will appear whenever there has been a power interruption to the appliance. To clear the PF message press CLEAR/OFF control pad and be sure to reset the clock with the correct time of day. • To clear the HS message press ON/OFF pad. |
| Oven light does not work. | <ul style="list-style-type: none"> • Replace or tighten bulb. See Changing Oven Light section in this Owner's manual. |
| Oven smokes excessively during broiling. | <ul style="list-style-type: none"> • Control not set properly. Follow instructions under Setting Oven Controls. • Meat too close to the element. Reposition the rack to provide proper clearance between the meat and the element. Preheat broil element for searing. • Meat not properly prepared. Remove excess fat from meat. Cut remaining fatty edges to prevent curling, but do not cut into lean. • Insert on broiler pan wrong side up and grease not draining. Always place grid on the broiler pan with ribs up and slots down to allow grease to drip into pan. • Grease has built up on oven surfaces. Regular cleaning is necessary when broiling frequently. Old grease or food spatters cause excessive smoking. |
| Food does not bake or roast properly | <ul style="list-style-type: none"> • Oven controls improperly set. <ul style="list-style-type: none"> - See the using the oven section. • Rack position is incorrect or the rack is not level. <ul style="list-style-type: none"> - See the using the oven section. • Incorrect cookware or cookware of improper size being used. <ul style="list-style-type: none"> - See the using the oven section. • Oven sensor needs to be adjusted. <ul style="list-style-type: none"> - See the adjusting your oven temperature in option section. |
| Food does not broil properly | <ul style="list-style-type: none"> • Oven controls improperly set. <ul style="list-style-type: none"> - Make sure you press the BROIL pad. • Improper rack position being used. <ul style="list-style-type: none"> - See the Broiling Guide. • Cookware not suited for broiling. <ul style="list-style-type: none"> - Use the broiling pan and grid that came with your range. |

TROUBLESHOOTING

| Problem | Possible cause / Solution |
|--|---|
| Food does not broil properly | <ul style="list-style-type: none"> • Aluminum foil used on the the broiling pan and grid has not been fitted properly and slit as recommended. <ul style="list-style-type: none"> - See the using the oven section. • In some areas the power (voltage) may be low. <ul style="list-style-type: none"> - Preheat the broil element for 10 minutes. - Broil for the longest period of time recommended in the Broiling Guide. |
| Oven temperature too hot or too cold | <ul style="list-style-type: none"> • Oven Sensor needs to be adjusted. <ul style="list-style-type: none"> - See the adjusting your oven Temperature in option section. |
| Scratches or abrasions on cooktop surface | <ul style="list-style-type: none"> • Coarse particles such as salt or sand between cooktop and utensils can cause scratches. Be sure cooktop surface and bottoms of utensils are clean before usage. Small scratches do not affect cooking and will become less visible with time. • Cleaning materials not recommended for ceramic-glass cooktop have been used. See "Cleaning the glass cooktop" in the MAINTENANCE section. • Cookware with rough bottom has been used. Use smooth, flat-bottomed cookware. |
| Metal marks | <ul style="list-style-type: none"> • Scraping of metal utensils on cooktop surface. Do not slide metal utensils on cooktop surface. Use a ceramic-glass cooktop cleaning cream to remove the marks. See "Cleaning the glass cooktop" in the MAINTENANCE section. |
| Brown streaks or specks | <ul style="list-style-type: none"> • Boilovers are cooked onto surface. Use the blade scraper to remove soil. See "Cleaning the glass cooktop" in the MAINTENANCE section. |
| Areas of discoloration with metallic sheen | <ul style="list-style-type: none"> • Mineral deposits from water and food. Remove using a ceramic-glass cooktop cleaning cream. Use cookware with clean, dry bottoms. |
| Oven will not self-clean | <ul style="list-style-type: none"> • The oven temperature is too high to set a self-clean operation. <ul style="list-style-type: none"> - Allow the range to cool and reset the controls. • Oven controls improperly set. <ul style="list-style-type: none"> - See the using the self-cleaning oven section. • A Self-Clean cycle cannot be started if Oven Lockout feature is active or radiant surface remains ON. |
| "Crackling" or "popping" sound | <ul style="list-style-type: none"> • This is the sound of the metal heating and cooling during both the cooking and cleaning functions. <ul style="list-style-type: none"> - This is normal. |
| Excessive smoking during a clean cycle | <ul style="list-style-type: none"> • Excessive soil. <ul style="list-style-type: none"> - Press the CLEAR/OFF pad. Open the windows to rid the room of smoke. Wait until the Self Clean Mode is cancelled. Wipe up the excess soil and reset the clean . |
| Oven door do not open after a clean cycle | <ul style="list-style-type: none"> • Oven is too hot. <ul style="list-style-type: none"> - Allow the oven to cool below locking temperature. |
| Oven not clean after a clean cycle | <ul style="list-style-type: none"> • Oven controls not properly set. <ul style="list-style-type: none"> - See the Using the self-cleaning oven section. • Oven was heavily soiled. <ul style="list-style-type: none"> - Clean up heavy spillovers before starting the clean cycle. Heavily soiled ovens may need to self-clean again or for a longer period of time. |

TROUBLESHOOTING

| Problem | Possible cause / Solution |
|---|---|
| "CLEAN" flashes in the display | <ul style="list-style-type: none"> • The self-clean cycle has been selected but the door is not closed. - Close the oven door. |
| "DOOR LOCKED" light is on when you want to cook | <ul style="list-style-type: none"> • The oven door is locked because the temperature inside the oven has not dropped below the locking temperature. - Press the CLEAR/OFF pad. Allow the oven to cool. |
| Steam from the vent | <ul style="list-style-type: none"> • When using the convection feature, it is normal to see steam coming out of the oven vent. As the number of racks or amount of food being cooked increases, the amount of visible steam will increase. - This is normal. |
| "Burning" or "oily" odor emitting from the vent | <ul style="list-style-type: none"> • This is normal in a new oven and will disappear in time. - To speed the process, set a self-clean cycle for a minimum of 3 hours. See the Using the self-cleaning oven section. |
| Fan noise | <ul style="list-style-type: none"> • A convection fan may automatically turn on and off. - This is normal. |
| Oven racks are difficult to slide | <ul style="list-style-type: none"> • The shiny, silver-colored racks were cleaned in a self-clean cycle. - Apply a small amount of vegetable oil to a paper towel and wipe the edges of the oven racks with the paper towel. Do not spray with Pam or other lubricant sprays. |
| Convection Fan stops | <ul style="list-style-type: none"> • Convection fan stops during a convection bake cycle. - This is normal and is done to allow for more even heating during the cycle. This is not a failure of the range and should be considered normal operation. |

LG ELECTRONICS CANADA, INC.

LG ELECTRIC OVEN LIMITED WARRANTY - Canada

WARRANTY : Should your LG Electric Oven ("Product") fail due to a defect in material or workmanship under normal home use during the warranty period set forth below, LG Canada will at its option repair or replace the Product upon receipt of proof of original retail purchase. This warranty is valid only to the original retail purchaser of the product and applies only to a Product distributed in Canada by LG Canada or an authorized Canadian distributor thereof. The warranty only applies to Products located and used within Canada.

| | |
|--|--|
| WARRANTY PERIOD: (Note: If the original date of purchase can not be verified, the warranty will begin sixty (60) days from the date of manufacture). | |
| Parts and Labor (internal/functional parts only) | Glass Cook top Radiant Surface units |
| One (1) year from the date of original retail purchase | One (1) year from the date of original retail purchase |

- Replacement products and parts are warranted for the remaining portion of the original warranty period or ninety (90) days, whichever is greater.
- Replacement products and parts may be new or remanufactured.
- LG Authorized Service Center warranties their repair work for thirty (30) days.

LG CANADA'S SOLE LIABILITY IS LIMITED TO THE WARRANTY SET OUT ABOVE. EXCEPT AS EXPRESSLY PROVIDED ABOVE, LG CANADA MAKES NO AND HEREBY DISCLAIMS ALL OTHER WARRANTIES AND CONDITIONS RESPECTING THE PRODUCT, WHETHER EXPRESS OR IMPLIED, INCLUDING, BUT NOT LIMITED TO, ANY IMPLIED WARRANTY OR CONDITION OF MERCHANTABILITY OR FITNESS FOR A PARTICULAR PURPOSE, AND NO REPRESENTATIONS SHALL BE BINDING ON LG CANADA. LG CANADA DOES NOT AUTHORIZE ANY PERSON TO CREATE OR ASSUME FOR IT ANY OTHER WARRANTY OBLIGATION OR LIABILITY IN CONNECTION WITH THE PRODUCT. TO THE EXTENT THAT ANY WARRANTY OR CONDITION IS IMPLIED BY LAW, IT IS LIMITED TO THE EXPRESS WARRANTY PERIOD ABOVE.

LG CANADA, THE MANUFACTURER OR DISTRIBUTOR SHALL NOT BE LIABLE FOR ANY INCIDENTAL, CONSEQUENTIAL, SPECIAL, DIRECT OR INDIRECT DAMAGES, LOSS OF GOODWILL, LOST PROFITS, PUNITIVE OR EXEMPLARY DAMAGES OR ANY OTHER DAMAGE, WHETHER ARISING DIRECTLY OR INDIRECTLY FROM ANY CONTRACTUAL BREACH, FUNDAMENTAL OR OTHERWISE, OR FROM ANY ACTS OR OMISSIONS, TORT, OR OTHERWISE.

This warranty gives you specific legal rights. You may have other rights which may vary from province to province depending on applicable provincial laws. Any term of this warranty that negates or varies any implied condition or warranty under provincial law is severable where it conflicts with provincial law without affecting the remainder of this warranty's terms.

THIS LIMITED WARRANTY DOES NOT COVER:

1. Service trips to deliver, pick up, or install the product; instructing a customer on operation of the product; repair or replacement of fuses or correction of wiring, or correction of unauthorized repairs/installation.
2. Failure of the product to perform during power failures and interruptions or inadequate electrical service.
3. Damage caused by leaky or broken water pipes, frozen water pipes, restricted drain lines, inadequate or interrupted water supply or inadequate supply of air.
4. Damage resulting from operating the Product in a corrosive atmosphere or contrary to the instructions outlined in the Product owner's manual.
5. Damage to the Product caused by accidents, pests and vermin, lightning, wind, fire, floods, or acts of God.
6. Damage resulting from the misuse, abuse, improper installation, repair, or maintenance of the Product. Improper repair includes use of parts not approved or specified by LG Canada.
7. Damage or product failure caused by unauthorized modification or alteration, or use for other than its intended purpose, or resulting from any water leakage due to improper installation.
8. Damage or Product failure caused by incorrect electrical current, voltage, commercial or industrial use, or use of accessories, components, or cleaning products that are not approved by LG Canada.
9. Damage caused by transportation and handling, including scratches, dents, chips, and/or other damage to the finish of your product, unless such damage results from defects in materials or workmanship and is reported within one (1) week of delivery.
10. Damage or missing items to any display, open box, discounted, or refurbished Product.
11. Products with original serial numbers that have been removed, altered, or cannot be readily determined. Model and Serial numbers, along with original retail sales receipt, are required for warranty validation.
12. Increases in utility costs and additional utility expenses.
13. Replacement of light bulbs, filters, or any consumable parts.
14. Repairs when your Product is used in other than normal and usual household use (including, without limitation, commercial use, in offices or recreational facilities) or contrary to the instructions outlined in the Product owner's manual.
15. Costs associated with removal of the Product from your home for repairs.
16. The removal and reinstallation of the Product if it is installed in an inaccessible location or is not installed in accordance with published installation instructions, including the Product owner's and installation manuals.
17. Accessories to the Product such as door bins, drawers, handles, shelves, etc. Also excluded are parts besides those that were originally included with the Product.

All costs associated with the above excluded circumstances shall be borne by the consumer.

For complete warranty details and customer assistance, please call or visit our website:

Call 1-888-542-2623 (24 hours a day, 365 days a year) and select the appropriate option from the menu, or visit our website at <http://www.lg.com>

Write your warranty information below:

Product Registration Information:

Model:

Serial Number:

Date of Purchase:



To contact LG Electronics
24 hours a day, 7 days a week:
1-888-542-2623 (CANADA)
Or visit us on the Web at: www.lg.com

Pour contacter LG Electronics
24h/24 et 7jours/7:
1-888-542-2623 (CANADA)
Ou consultez notre site Internet au: www.lg.com