



LG

Life's Good

OWNER'S MANUAL PLASMA TV

Please read this manual carefully before operating the set and retain it for future reference.

42PA4500
50PA4500

42PA4900
50PA4900

50PA6500
60PA6500

LICENSES

Supported licenses may differ by model. For more information about licenses, visit www.lg.com.



Manufactured under license from Dolby Laboratories. "Dolby" and the double-D symbol are trademarks of Dolby Laboratories.



HDMI, the HDMI logo and High-Definition Multimedia Interface are trademarks or registered trademarks of HDMI Licensing LLC.



ABOUT DIVX VIDEO: DivX® is a digital video format created by DivX, LLC, a subsidiary of Rovi Corporation. This is an official DivX Certified® device that plays DivX video. Visit divx.com for more information and software tools to convert your files into DivX video.

ABOUT DIVX VIDEO-ON-DEMAND: This DivX Certified® device must be registered in order to play purchased DivX Video-on-Demand (VOD) movies. To obtain your registration code, locate the DivX VOD section in your device setup menu. Go to vod.divx.com for more information on how to complete your registration.

"DivX Certified® to play DivX® video up to HD 1080p, including premium content."

"DivX®, DivX Certified® and associated logos are trademarks of Rovi Corporation or its subsidiaries and are used under license."

"Covered by one or more of the following U.S. patents:
7,295,673; 7,460,668; 7,515,710; 7,519,274"



NOTE

- Image shown may differ from your TV.
- Your TV's OSD (On Screen Display) may differ slightly from that shown in this manual.

IMPORTANT SAFETY INSTRUCTIONS

Always comply with the following precautions to avoid dangerous situations and ensure peak performance of your product.





WARNING / CAUTION

**RISK OF ELECTRIC SHOCK
DO NOT OPEN**



TO REDUCE THE RISK OF ELECTRIC SHOCK DO NOT REMOVE COVER (OR BACK). NO USER SERVICEABLE PARTS INSIDE. REFER TO QUALIFIED SERVICE PERSONNEL.

 The lightning flash with arrowhead symbol, within an equilateral triangle, is intended to alert the user to the presence of uninsulated "dangerous voltage" within the product's enclosure that may be of sufficient magnitude to constitute a risk of electric shock to persons.

 The exclamation point within an equilateral triangle is intended to alert the user to the presence of important operating and maintenance (servicing) instructions in the literature accompanying the appliance.

WARNING/CAUTION

- TO REDUCE THE RISK OF FIRE AND ELECTRIC SHOCK, DO NOT EXPOSE THIS PRODUCT TO RAIN OR MOISTURE.

Read these instructions.
Keep these instructions.
Heed all warning.
Follow all instruction.



- Do not use this apparatus near water.



- Clean only with dry cloth.



- Do not block any ventilation openings. Install in accordance with the manufacturer's instructions.



- Do not install near any heat sources such as radiators, heat registers, stoves, or other apparatus (including amplifiers) that produce heat.



- Do not defeat the safety purpose of the polarized or grounding-type plug. A polarized plug has two blades with one wider than the other. A grounding-type plug has two blades and a third grounding prong. The wide blade or the third prong are provided for your safety. If the provided plug does not fit into your outlet, consult an electrician for replacement of the obsolete outlet. (Can differ by country)



- Protect the power cord from being walked on or pinched particularly at plugs, convenience receptacles, and the point where they exit from the apparatus.



- Only use attachments/accessories specified by the manufacturer.



- Use only with a cart, stand, tripod, bracket, or table specified by the manufacturer, or sold with the apparatus. When a cart is used, use caution when moving the cart/apparatus combination to avoid injury from tip-over.



- Unplug this apparatus during lightning storms or when unused for long periods of time.

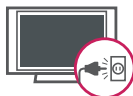

- Refer all servicing to qualified service personnel. Servicing is required when the apparatus has been damaged in any way, such as power-supply cord or plug is damaged, liquid has been spilled or objects have fallen into the apparatus, the apparatus has been exposed to rain or moisture, does not operate normally, or has been dropped.

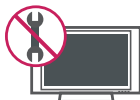

- Never touch this apparatus or antenna during a thunder or lightning storm.
- When mounting a TV on the wall, make sure not to install the TV by hanging the power and signal cables on the back of the TV.

- Do not allow an impact shock or any objects to fall into the product, and do not drop anything onto the screen.

- CAUTION concerning the Power Cord: It is recommended that appliances be placed upon a dedicated circuit; that is, a single outlet circuit which powers only that appliance and has no additional outlets or branch circuits. Check the specification page of this owner's manual to be certain. Do not connect too many appliances to the same AC power outlet as this could result in fire or electric shock. Do not overload wall outlets. Overloaded wall outlets, loose or damaged wall outlets, extension cords, frayed power cords, or damaged or cracked wire insulation are dangerous. Any of these conditions could result in electric shock or fire. Periodically examine the cord of your appliance, and if its appearance indicates damage or deterioration, unplug it, discontinue use of the appliance, and have the cord replaced with an exact replacement part by an authorized service. Protect the power cord from physical or mechanical abuse, such as being twisted, kinked, pinched, closed in a door, or walked upon. Pay particular attention to plugs, wall outlets, and the point where the cord exits the appliance. Do not move the TV with the power cord plugged in. Do not use a damaged or loose power cord. Be sure do grasp the plug when unplugging the power cord. Do not pull on the power cord to unplug the TV.



- **Warning** - To reduce the risk of fire or electrical shock, do not expose this product to rain, moisture or other liquids. Do not touch the TV with wet hands. Do not install this product near flammable objects such as gasoline or candles, or expose the TV to direct air conditioning.



- Do not expose to dripping or splashing and do not place objects filled with liquids, such as vases, cups, etc. on or over the apparatus (e.g. on shelves above the unit).



• **Grounding**

Ensure that you connect the earth ground wire to prevent possible electric shock (i.e. a TV with a three-prong grounded AC plug must be connected to a three-prong grounded AC outlet). If grounding methods are not possible, have a qualified electrician install a separate circuit breaker. Do not try to ground the unit by connecting it to telephone wires, lightning rods, or gas pipes.

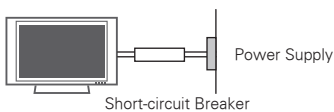

• **DISCONNECTING DEVICE FROM THE MAIN POWER**

The power outlet must remain readily accessed in the event the device needs to be unplugged.

- As long as this unit is connected to the AC wall outlet, it is not disconnected from the AC power source even if the unit is turned off.
- Do not attempt to modify this product in any way without written authorization from LG Electronics. Unauthorized modification could void the user's authority to operate this product.

• **ANTENNAS Outdoor antenna grounding**

(Can differ by country):

If an outdoor antenna is installed, follow the precautions below. An outdoor antenna system should not be located in the vicinity of overhead power lines or other electric light or power circuits, or where it can come in contact with such power lines or circuits as death or serious injury can occur. Be sure the antenna system is grounded so as to provide some protection against voltage surges and built-up static charges. Section 810 of the National Electrical Code (NEC) in the U.S.A. provides information with respect to proper grounding of the mast and supporting structure, grounding of the lead-in wire to an antenna discharge unit, size of grounding conductors, location of antenna discharge unit, connection to grounding electrodes and requirements for the grounding electrode.

Antenna grounding according to the National Electrical Code, ANSI/NFPA 70

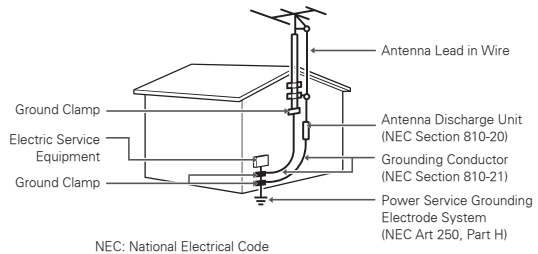

• **Cleaning**

When cleaning, unplug the power cord and wipe gently with a soft cloth to prevent scratching. Do not spray water or other liquids directly on the TV as electric shock may occur. Do not clean with chemicals such as alcohol, thinners or benzene.

• **Moving**

Make sure the product is turned off, unplugged and all cables have been removed. It may take 2 or more people to carry larger TVs. Do not press or put stress on the front panel of the TV.

- **Ventilation**

Install your TV where there is proper ventilation. Do not install in a confined space such as a bookcase. Do not cover the product with cloth or other materials while plugged. Do not install in excessively dusty places.

- If you smell smoke or other odors coming from the TV, unplug the power cord and contact an authorized service center.
- Do not press strongly upon the panel with your hand or a sharp object such as a nail, pencil or pen, or make a scratch on it.
- Keep the product away from direct sunlight.



- **Dot Defect**

The Plasma or LCD panel is a high technology product with resolution of two million to six million pixels. In a very few cases, you could see fine dots on the screen while you're viewing the TV. Those dots are deactivated pixels and do not affect the performance and reliability of the TV.

- **Generated Sound**

"Cracking" noise: A cracking noise that occurs when watching or turning off the TV is generated by plastic thermal contraction due to temperature and humidity. This noise is common for products where thermal deformation is required.

Electrical circuit humming/panel buzzing: A low level noise is generated from a high-speed switching circuit, which supplies a large amount of current to operate a product. It varies depending on the product.

This generated sound does not affect the performance and reliability of the product.

- Take care not to touch the ventilation openings. When watching the TV for a long period, the ventilation openings may become hot. This does not affect the performance of the product or cause defects in the product.

TABLE OF CONTENTS

2 LICENSES

3 IMPORTANT SAFETY INSTRUCTIONS

7 TABLE OF CONTENTS

9 INSTALLATION PROCEDURE

9 ASSEMBLING AND PREPARING

- 9 Unpacking
- 11 Optional Extras
- 12 Parts and buttons
- 13 Lifting and moving the TV
- 14 Setting up the TV
 - 14 - Attaching the stand
 - 16 - Mounting on a table
 - 17 - Mounting on a wall
 - 18 - Tidying cables

19 REMOTE CONTROL

23 WATCHING TV

- 23 Turning the TV on for the first time
- 24 Watching TV
- 24 Managing channels
 - 24 - Setting up channels
 - 25 - Using favorite channels
 - 26 - Checking current program info
- 28 EPG (Electronic Program Guide) (In digital mode)
 - 28 - NOW/NEXT Guide Mode
 - 28 - 8 Day Guide Mode
 - 28 - Date Setting Mode

- 28 - Detailed Information Box
- 29 - Manual Timer Mode
- 29 - Schedule List Mode
- 30 Using additional options
 - 30 - Adjusting aspect ratio
 - 31 - Changing AV modes
 - 31 - Using the input list
 - 32 - Locking the buttons on the TV (Child Lock)
- 33 Using the quick menu
- 33 Using the customer support
 - 33 - Testing the Picture / Sound
 - 33 - Using the product or service information

34 PENTOUCH (FOR PENTOUCH TV)

- 34 Using Pentouch
 - 35 - Step of using the Pentouch Program
 - 35 - System Requirements
 - 35 - Installing the Pentouch Program
 - 35 - Removing the Pentouch Program
 - 36 - Pairing between Touch Pen and Dongle
 - 39 - Using the Pentouch Function
 - 39 - Display Resolution Settings for Pentouch
- 41 Checking the Pentouch Functions
 - 42 - Using Toolbar
 - 43 - Using Sketchbook
 - 45 - Using Photo Editor
 - 47 - Using Family Diary
 - 47 - Using Gallery
 - 48 - Using Internet
 - 49 - Using My Office

50 ENTERTAINMENT

- 50 - Connecting USB storage devices
- 51 - Browsing files
- 53 - Viewing Videos
- 56 - DivX® VOD Guide
- 57 - Viewing Photos
- 59 - Listening to music

61 CUSTOMIZING TV SETTINGS

- 61 The Main Menu
- 62 Customizing Settings
- 62 - PICTURE Settings
- 65 - AUDIO Settings
- 67 - CHANNEL Settings
- 68 - TIME Settings
- 69 - LOCK Settings
- 70 - OPTION Settings

72 MAKING CONNECTIONS

- 72 Connecting to an antenna or cable
- 73 Connection Overview
- 74 Connecting to a HD receiver, DVD, or VCR player
- 74 - HDMI Connection
- 75 - DVI to HDMI Connection
- 76 - Component Connection
- 77 - Composite Connection
- 78 Connecting to a PC
- 78 - HDMI Connection, DVI to HDMI Connection or RGB Connection
- 80 Connecting to an Audio System
- 80 - Digital Optical Audio Connection
- 81 Connecting to a USB
- 82 SIMPLINK Connection
- 82 - Activating and Using the SIMPLINK menus

83 MAINTENANCE

- 83 Updating the TV Firmware
- 84 Cleaning Your TV
- 84 - Screen, frame, cabinet and stand
- 84 - Power cord
- 84 Preventing "Image burn" or "Burn-in" on your TV screen

85 TROUBLESHOOTING

88 SPECIFICATIONS

91 IR CODES

92 EXTERNAL CONTROL DEVICE SETUP

100 OPEN SOURCE LICENSE

INSTALLATION PROCEDURE

- 1 Open the package and make sure all the accessories are included.
- 2 Attach the stand to the TV set.
- 3 Connect an external device to the TV set.

ASSEMBLING AND PREPARING

Unpacking

Check your product box for the following items. If there are any missing accessories, contact the local dealer where you purchased your product. The illustrations in this manual may differ from the actual product and item.

For PA4500, PA6500 series

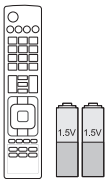

**Remote control,
Batteries (AAA)**
(See p.19)

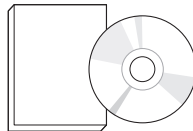

**Owner's manual,
CD manual**



Power Cord

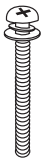

Stand Screws
4 EA, M4 x 30
(See p.14, p.15)



Stand Screws
3 EA, M5 x 16
(See p.14)

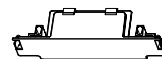

Protection cover
(See p.15)



Power Cord holder
(See p.18)

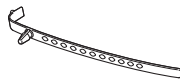

Cable holder
(See p.18)



Polishing cloth
(Depending on model)
Use this to remove dust
from the cabinet.



Stand Body
(See p.14)

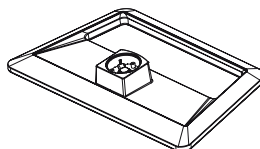

Stand Base
(See p.14)

For PA4900 series

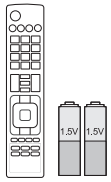

**Remote control,
Batteries (AAA)**
(See p.19)

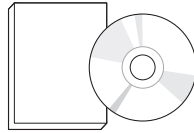

**Owner's manual,
CD manual (Included
Pentouch Software)**

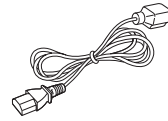

Power Cord

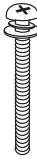

Stand Screws
4 EA, M4 x 30
(See p.14, p.15)



Stand Screws
3 EA, M5 x 16
(See p.14)

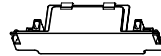

Protection cover
(See p.15)



Power Cord holder
(See p.18)

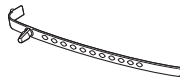

Cable holder
(See p.18)



Polishing cloth
(Depending on model)
Use this to remove dust
from the cabinet.



Stand Body
(See p.14)

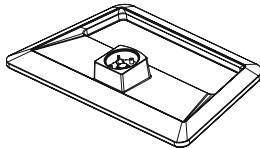

Stand Base
(See p.14)

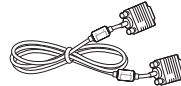

D-sub 15 pin signal cable



Eye-bolt & Wall bracket
2 EA
(See p.16)

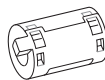

Ferrite core
2 EA
(See p.38)



Touch Pen
The number of touch pen
may differ depending on the
model.
(See p.36)

**Tip**

The number of tip may differ depending on the model.
(See p.38)

**Cradle**

(See p.36)

**Touch Pen Dongle**

(See p.36)

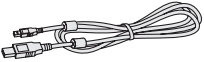
**Charging Cable**

(See p.38)

Optional Extras

Optional extras can be changed or modified for quality improvement without any notification. Contact your dealer to buy these items. These devices only work with certain models.

**AN-TP300**

Touch Pen, Cradle

The number of touch pen and tip may differ depending on the model.

Compatibility	PA4500	PA4900	PA6500
AN-TP300 Touch Pen, Cradle		●	

**NOTE**

- The items supplied with your product may vary depending on the model.
- Product specifications or contents of this manual may be changed without prior notice due to upgrade of product functions.

**CAUTION**

- Do not use any unapproved items to ensure the safety and product life span.
- Any damages or injuries by using unapproved items are not covered by the warranty.
- In case of some models, the thin film on screen is a part of TV, So don't take it off.

Parts and buttons

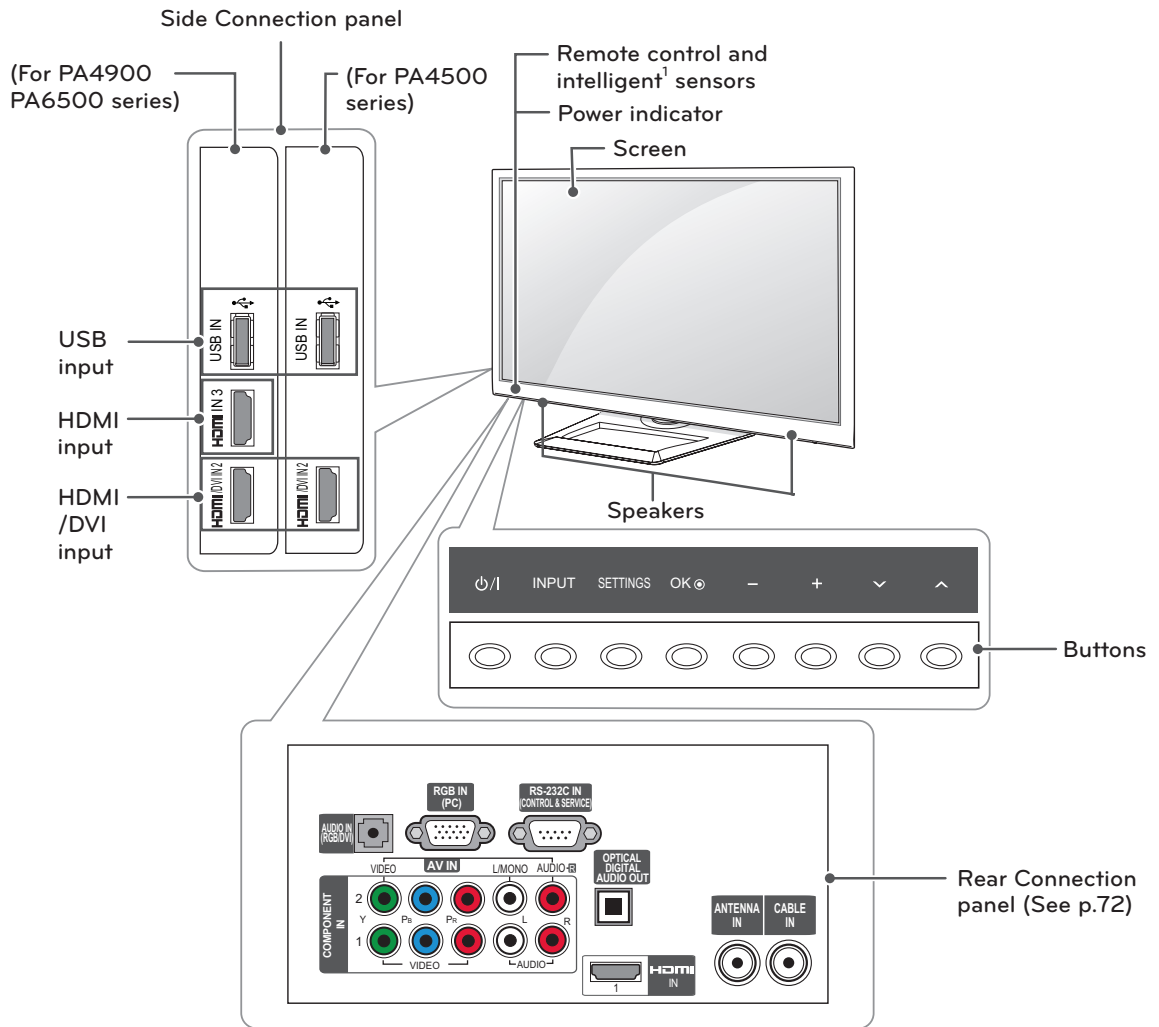

ENGLISH

Button	Description
⏻ / I	Turns the power on or off.
INPUT	Changes the input source.
SETTINGS	Accesses the main menus, or saves your input and exits the menus.
OK	Selects the highlighted menu option or confirms an input.
- +	Adjusts the volume level.
⏪ ⏩	Scrolls through the saved channels.

1 Intelligent sensor - Adjusts the image quality and brightness based on the surrounding environment.

Lifting and moving the TV

When moving or lifting the TV, read the following to prevent the TV from being scratched or damaged and for safe transportation regardless of its type and size.



CAUTION

- Avoid touching the screen at all times, as this may result in damage to the screen.
- It is recommended to move the TV in the box or packing material that the TV originally came in.
- Before moving or lifting the TV, disconnect the power cord and all cables.
- When holding the TV, the screen should face away from you to prevent the screen from scratches.



- Hold the top and bottom of the TV frame firmly. Make sure not to hold the transparent part, speaker, or speaker grill area.

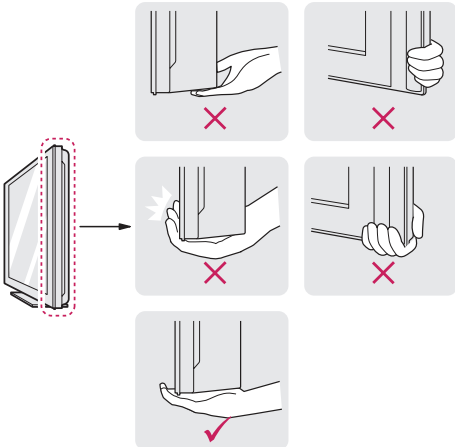

- When transporting a large TV, there should be at least 2 people.
- When transporting the TV by hand, hold the TV as shown in the following illustration.

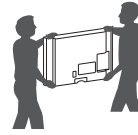

- When transporting the TV, do not expose the TV to jolts or excessive vibration.
- When transporting the TV, keep the TV upright, never turn the TV on its side or tilt towards the left or right.

Setting up the TV

Put your TV on a pedestal stand and mount the TV on a table or wall.

Attaching the stand

If you are not mounting the TV to a wall, use the following instructions to attach the stand.

1

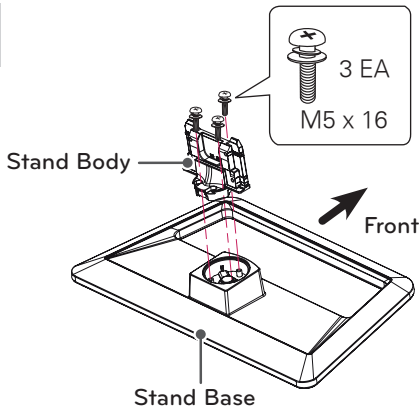

2

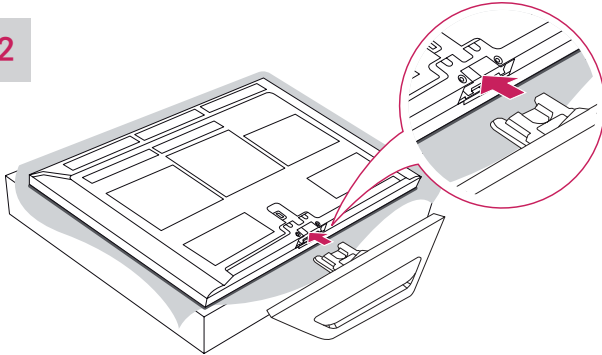

! CAUTION

- When attaching the stand to the TV set, place the screen facing down on a cushioned table or flat surface to protect the screen from scratches.

3

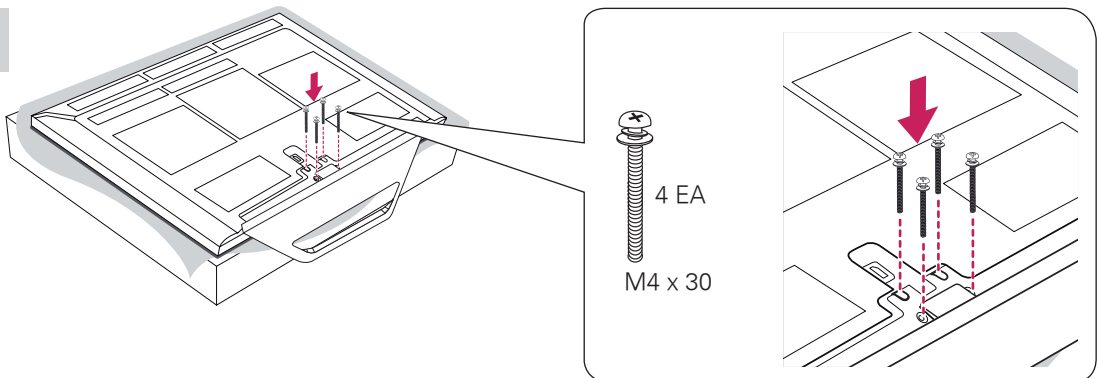

! CAUTION

- Tighten the screws firmly to prevent the TV from tilting forward. Do not over tighten.

To detach the stand,

1

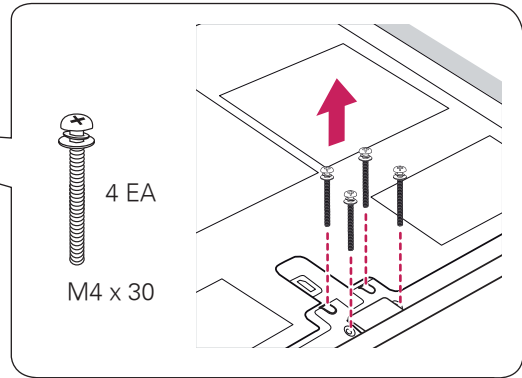
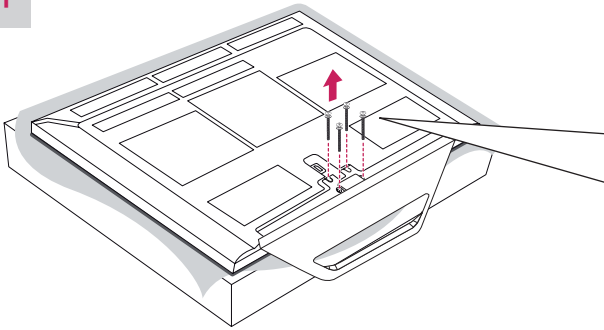

CAUTION

- When attaching the stand to the TV set, place the screen facing down on a cushioned table or flat surface to protect the screen from scratches.

2

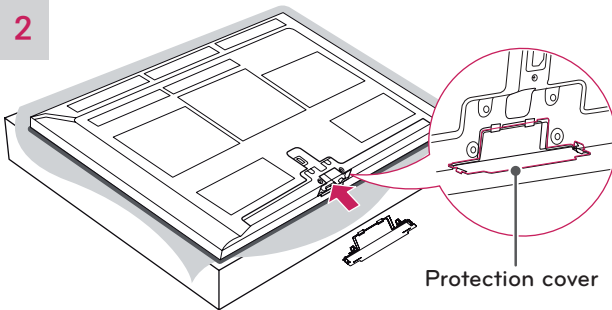

NOTE

- This will protect the opening from accumulating dust and dirt.
- When installing the wall mounting bracket, use the Protection cover.

3

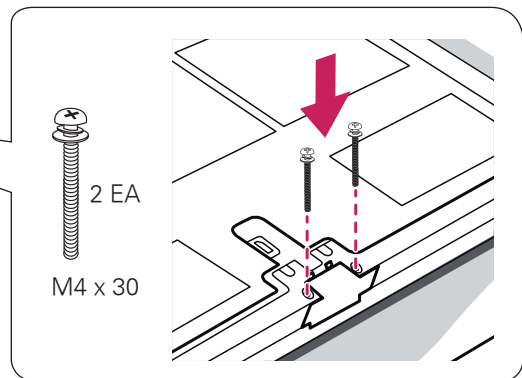
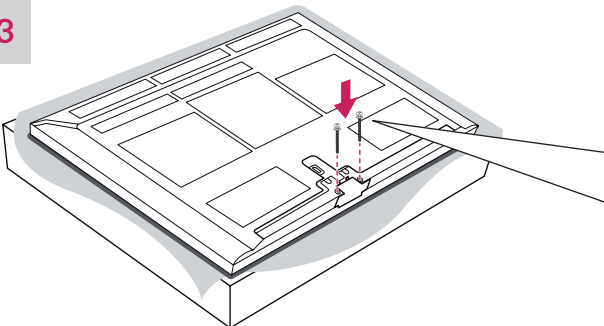

CAUTION

- Tighten the screws firmly to prevent the TV from tilting forward. Do not over tighten.

Mounting on a table

- 1 Lift and tilt the TV into its upright position on a table.
 - Leave a 10 cm (minimum) space from the wall for proper ventilation.

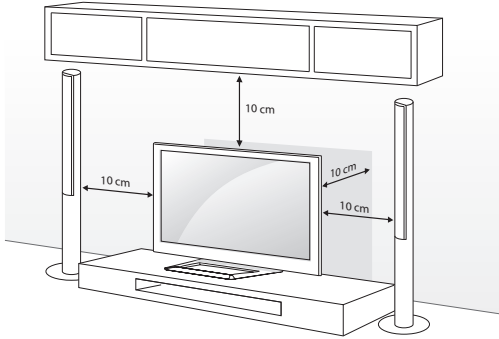

- 2 Connect the power cord to a wall outlet.



CAUTION

- Do not place the TV near or on sources of heat, as this may result in fire or other damage.



NOTE

- Swivel 20 degrees to the left or right and adjust the angle of the TV to suit your view.
- When adjusting the angle of the product, watch out for your fingers.

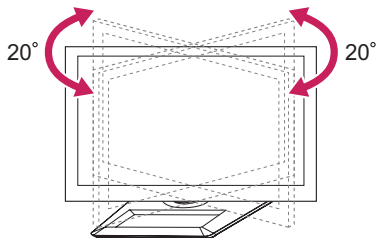

Securing the TV to a wall (For PA4900 series)

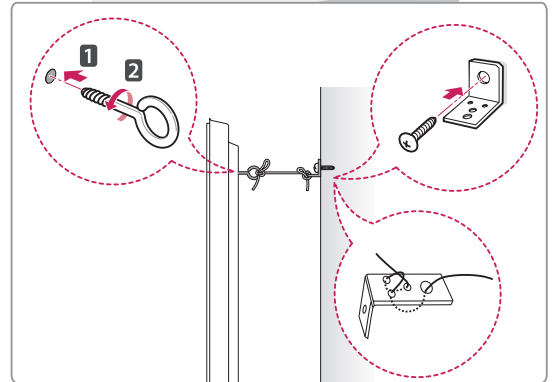
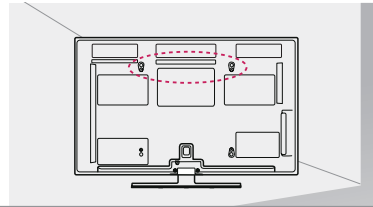

- 1 Insert and tighten the eye-bolts on the back of the TV.
 - If there are bolts inserted at the eye-bolts position, remove the bolts first.
- 2 Mount the wall brackets with the bolts to the wall.

Match the location of the wall bracket and the eye-bolts on the rear of the TV.
- 3 Connect the eye-bolts and wall brackets tightly with a sturdy rope.

Make sure to keep the rope horizontal with the flat surface.



CAUTION

- Make sure that children do not climb on or hang on the TV.



NOTE

- Use a platform or cabinet that is strong and large enough to support the TV securely.

Mounting on a wall

Attach an optional wall mount bracket at the rear of the TV carefully and install the wall mount bracket on a solid wall perpendicular to the floor. When you attach the TV to other building materials, please contact qualified personnel. We recommend that you use an LG brand wall mount when mounting the TV to a wall.

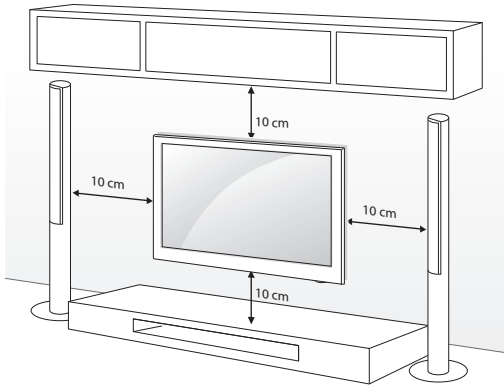

Make sure to use screws and wall mounts that meet the VESA standard. Standard dimensions for the wall mount kits are described in the following table.

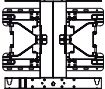
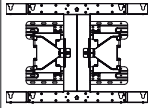
Model	42/50PA4500 42/50PA4900 50PA6500	60PA6500
VESA	400 x 400	600 x 400
Standard screw	M6	M8
Number of screws	4	4
Wall mount bracket (optional)	PSW400B, PSW400BG 	PSW600B, PSW600BG 

CAUTION

- Disconnect the power first, and then move or install the TV. Otherwise electric shock may occur.
- If you install the TV on a ceiling or slanted wall, it may fall and result in severe injury. Use an authorized LG wall mount and contact the local dealer or qualified personnel.
- Do not over tighten the screws as this may cause damage to the TV and void your warranty.
- Use only screws and wall mounts that meet the VESA standard. Any damages or injuries by misuse or using an improper accessory are not covered by the warranty.

NOTE

- Use only screws that are listed on the VESA standard screw specifications.
- The wall mount kit includes an installation manual and necessary parts.
- The wall mount bracket is optional. You can obtain additional accessories from your local dealer.
- The length of screws may differ depending on the wall mount. Make sure to use the proper length.
- For more information, refer to the manual supplied with the wall mount.

Tidying cables

- 1 Install the power cord holder and power cord. It will help prevent the power cable from being removed by accident.

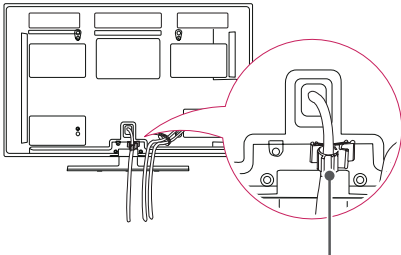

Power cord holder

- 2 Gather and bind the cables with the cable holder.

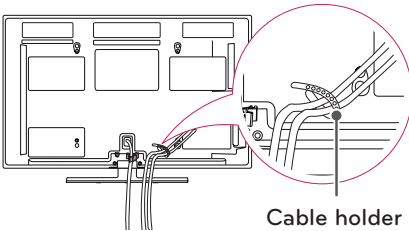

Cable holder



CAUTION

- Do not move the TV by holding the cable holder and power cord holder, as the cable holders may break, and injuries and damage to the TV may occur.

REMOTE CONTROL

The descriptions in this manual are based on the buttons on the remote control.

Please read this manual carefully and use the TV correctly.

To replace batteries, open the battery cover, replace batteries (1.5 V AAA) matching the ⊕ and ⊖ ends to the label inside the compartment, and close the battery cover. To remove the batteries, perform the installation actions in reverse.

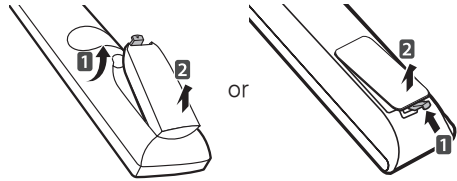

! CAUTION

- Do not mix old and new batteries, as this may damage the remote control.

Make sure to point the remote control toward at the remote control sensor on the TV.

For 42PA4500



⏻ (POWER)

Turns the TV on or off.

⏻ ENERGY SAVING (See p.62)

Adjusts the brightness of the screen to reduce energy consumption.

TV

Returns to the last TV channel.

GUIDE (See p.28)

Displays the program event according to time scheduler.

INFO ⓘ (See p.26)

Views the information of the current program and screen.

📺 RATIO (See p.30)

Resizes an image.

📺 INPUT (See p.31)

Changes the input source; Turns the TV on.

Number button

Enters numbers.

LIST (See p.25), - (Dash)

LIST: Accesses the saved channel list.
- (Dash): Inserts a dash between numbers such as 2-1 and 2-2.

Q.VIEW

Alternates between the two last channels selected (pressing repeatedly).

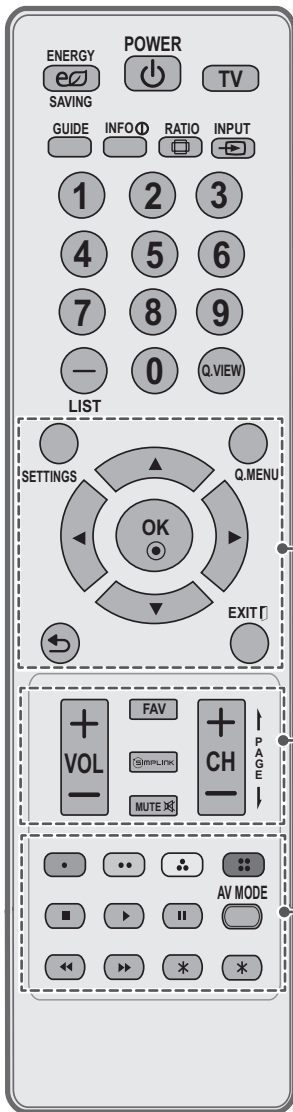
**SETTINGS**

Accesses the main menu.

Q. MENU (See p.33)

Accesses the quick menu.

Navigation buttons (up/down/left/right)

Scrolls through menus or options.

OK

Selects menus or options and confirms your input.

↶ (BACK)

Returns to the previous level.

EXIT

Clears all on-screen displays and returns to TV viewing.

+ VOL -

Adjusts the volume level.

FAV (See p.25)

Accesses your favorite channel list.;
Selects a menu or option.

 SIMPLINK (See p.82)

Accesses the AV devices connected to the TV;
Opens the SIMPLINK menu.

MUTE

Mutes all sounds.

+ CH -, ↑ PAGE ↓

CH: Scrolls through the saved channels.
PAGE: Moves to the previous or next screen.

Color buttons

These access special functions in some menus.

Control buttons

Controls the SIMPLINK compatible devices (USB, SIMPLINK).

|| (FREEZE)

Freezes the current frame (Not supported when using USB Mode and Simplink).

AV MODE (See p.31)

Selects an AV mode.

Not functional

For 50PA4500, PA4900, PA6500 series

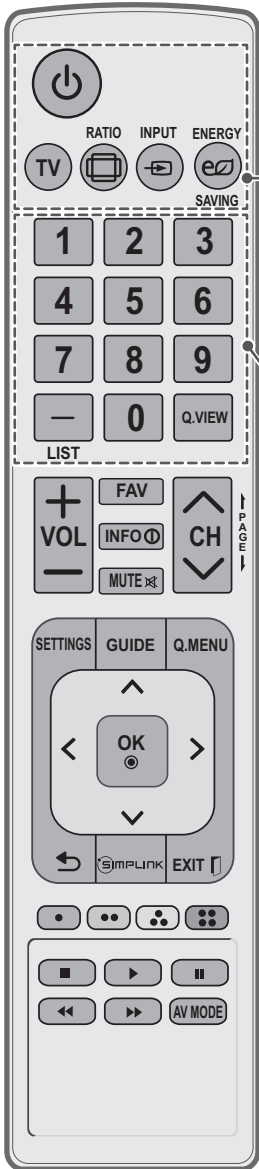

⏻ (POWER)
Turns the TV on or off.

TV
Returns to the last TV channel.

🖼️ RATIO (See p.30)
Resizes an image.

📺 INPUT (See p.31)
Changes the input source; Turns the TV on.

⚡ ENERGY SAVING (See p.62)
Adjusts the brightness of the screen to reduce energy consumption.

Number button
Enters numbers.

LIST (See p.25), - (Dash)
LIST: Accesses the saved channel list.
- (Dash): Inserts a dash between numbers such as 2-1 and 2-2.

Q.VIEW
Alternates between the two last channels selected (pressing repeatedly).

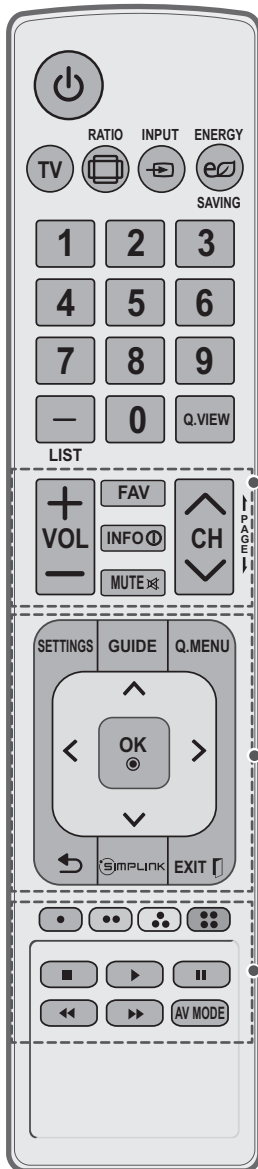
**+ VOL -**

Adjusts the volume level.

FAV (See p.25)

Accesses your favorite channel list.;
Selects a menu or option.

INFO ⓘ (See p.26)

Views the information of the current program and screen.

MUTE ✕

Mutes all sounds.

^ CH v, ↓ PAGE |

CH: Scrolls through the saved channels.

PAGE: Moves to the previous or next screen.

SETTINGS

Accesses the main menu.

GUIDE (See p.28)

Displays the program event according to time scheduler.

Q. MENU (See p.33)

Accesses the quick menu.

Navigation buttons (up/down/left/right)

Scrolls through menus or options.

OK ●

Selects menus or options and confirms your input.

↶ (BACK)

Returns to the previous level.

SIMPLINK (See p.82)

Accesses the AV devices connected to the TV;
Opens the SIMPLINK menu.

EXIT □

Clears all on-screen displays and returns to TV viewing.

Color buttons

These access special functions in some menus.

Control buttons

Controls the SIMPLINK compatible devices (USB, SIMPLINK).

|| (FREEZE)

Freezes the current frame (Not supported when using USB Mode and Simplink).

AV MODE (See p.31)

Selects an AV mode.

WATCHING TV

Turning the TV on for the first time

When you turn the TV on for the first time, the Initial setting screen appears. Select a language and customize the basic settings.

- 1 Connect the power cord to a power outlet.
- 2 In Standby mode, press the power button on the remote control to turn the TV on.

The Initial setting screen appears if you turn the TV on for the first time.

! NOTE

- You can also access **Initial Setting** by accessing **OPTION** in the main menu.

- 3 Follow the on-screen instructions to customize your TV settings according to your preferences.

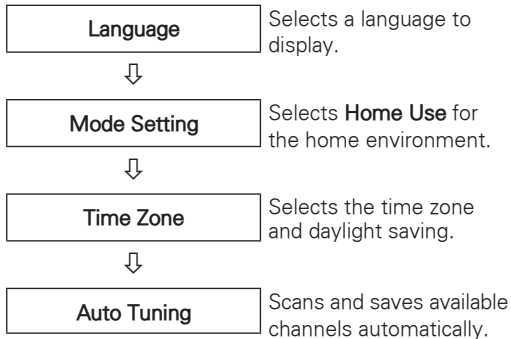

! NOTE

- To display images in the best quality for your home environment, select **Home Use**.
- **Store Demo** is suitable for the retail environment.
- If you select **Store Demo**, any customized settings will switch back to the default settings of **Store Demo** in 5 minutes.

- 4 When the basic settings are complete, press **OK**.

! NOTE

- If you do not complete the Initial setting, it will appear whenever the TV turns on.
- Disconnect the power cord from the power outlet when you do not use the TV for a long period of time.

- 5 To turn the TV off, press the power button on the remote control.

Watching TV

- 1 In Standby mode, press the power button on the remote control to turn the TV on.
- 2 Press **INPUT** and select TV.
- 3 Control the TV using the following buttons while you are watching TV.

Button	Description
CH (^, v or +, -)	Scrolls through saved channels.
LIST ¹	Selects a channel on the saved channel list.
0 - 9	Selects a channel by entering numbers.
VOL (+, -)	Adjusts the volume level.
MUTE	Mutes all sounds.
AV MODE ²	Selects an AV mode (See p.31).
Q.MENU	Accesses the quick menus (See p.33).
Q.VIEW	Alternates between the last two channels selected.
RATIO	Resizes an image (See p.30).
(FREEZE)	Freezes the current frame while you are watching TV.

- 1 The Lock icon (🔒) appears in front of a channel blocked with parental control.
- 2 Each **AV mode** has the optimized image and sound settings. If you select **Off**, the image and sound settings will be restored to the previously customized settings.
- 4 To turn the TV off, press the power button on the remote control.
The TV switches to Standby mode.

Managing channels

Setting up channels

Storing channels

To store channels automatically,

- 1 Press **SETTINGS** to access the main menus.
- 2 Press the Navigation buttons to scroll to **CHANNEL** and press **OK**.
- 3 Press the Navigation buttons to scroll to **Auto Tuning** and press **OK**.
- 4 Select **Start** to start automatic tuning.
The TV scans and saves available channels automatically.

NOTE

- If the TV scans and saves channels, the previously saved channels will be overwritten.

- 5 When you are finished, press **EXIT**.
When you return to the previous menu, press **↩ (BACK)**.

To store channels manually,

- 1 Press **SETTINGS** to access the main menus.
- 2 Press the Navigation buttons to scroll to **CHANNEL** and press **OK**.
- 3 Press the Navigation buttons to scroll to **Manual Tuning** and press **OK**.
- 4 Scroll through the channel types, and then add or delete channels.
- 5 When you are finished, press **EXIT**.
When you return to the previous menu, press **↩ (BACK)**.

NOTE

- If the TV scans a blocked channel, you will be prompted to enter your password to keep the channel scanned.
- You can store up to 1000 channels. The number of channels that you can store differs depending on the broadcasting signal environment.
- The channels are stored in the order of **DTV**, **TV** and **Cable TV**.

Editing your channel list

- 1 Press **SETTINGS** to access the main menus.
- 2 Press the Navigation buttons to scroll to **CHANNEL** and press **OK**.
- 3 Press the Navigation buttons to scroll to **Channel Edit** and press **OK**.
- 4 Edit channels using the following buttons.

Button	Description
^	Highlights the channel type.
^, v, <, >	Scrolls through channel types or channels.
OK	Selects the highlighted channel to view.
CH (^, v or +, -)	Moves to the previous or next page
Blue button	Adds or deletes a channel. The deleted channel displays in blue.
FAV	Registers or cancels the current channel in favorite channel list.
Q.MENU	Selects your desired favorite channel group.
Yellow button	Blocks or unblocks a channel.

- 5 When you are finished, press **EXIT**.
When you return to the previous menu, press **↶ (BACK)**.

Selecting a channel on the channel list

- 1 Press **LIST** to access the channel list.
 - To move to the previous or next page, press **CH (^, v or +, -)**.
 - To tune to the "CHANNEL menu - Channel Edit", press **Blue** button.
- 2 Select a channel you want and press **OK**.

! NOTE

- The Lock icon (🔒) appears in front of a channel blocked with parental control.
- If you select the blocked channel, you will be prompted to enter your password.

Using favorite channels

Add the channels that you watch frequently to the favorite list.

Setting up your favorite list

- 1 Select a channel to add to the favorite list.
- 2 Press **FAV**.
- 3 Press the Navigation buttons to select your desired favorite channel group.
- 4 Press the **Yellow** button to register or cancel the current channel in favorite channel list. Press the **Blue** button to move to **Channel Edit**.
- 5 Press the Navigation buttons to scroll to **Favorite**.
- 6 Press **OK** to add the selected channel to the favorite list.
- 7 When you are finished, press **EXIT**.

! NOTE

- You can also setup Favorite List in the **CHANNEL** menu - **Channel Edit**.

Selecting a channel on the favorite list

- 1 Press **FAV** to access the favorite list.
 - To move to the previous or next page, press **CH (^, v or +, -)**.
- 2 Select a channel you want and press **OK**.

Checking current program info

Press **OK** to view the information of the currently program while you are watching.
The following information appears at the top of the screen.

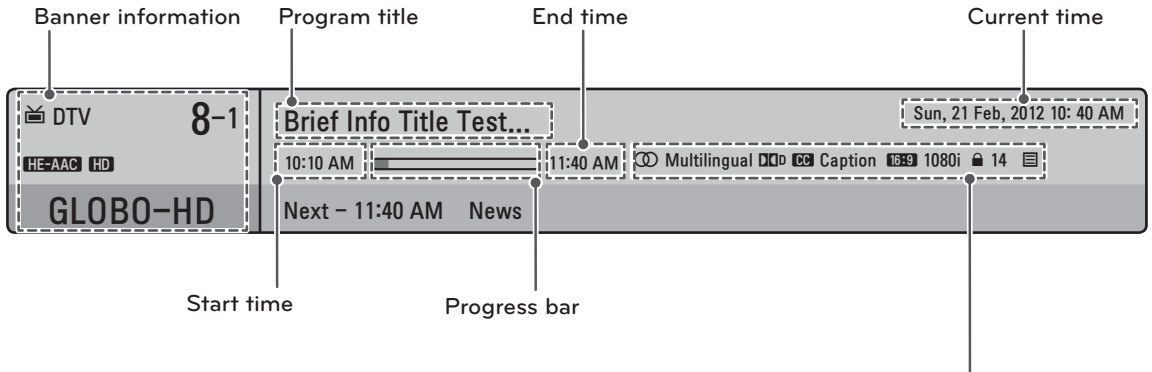

Icon		Description
Multilingual		The program contains two or more audio language services. You can change the audio language using the quick menu.
Dolby Digital		The program contains a Dolby Digital audio signal in TV and HDMI input sources.
Caption		The program contains one or more language caption services. You can change the caption language using the quick menu.
Aspect ratio		The original aspect ratio of the video is 4:3. The original aspect ratio of the video is 16:9 (wide).
Resolution		The video resolution is 720 x 480i. The video resolution is 720 x 480p. The video resolution is 1280 x 720p. The video resolution is 1920 x 1080i. The video resolution is 1920 x 1080p.
Rating		The program contains Rating information. See "LOCK Settings" on p.69.
Description		Caption description

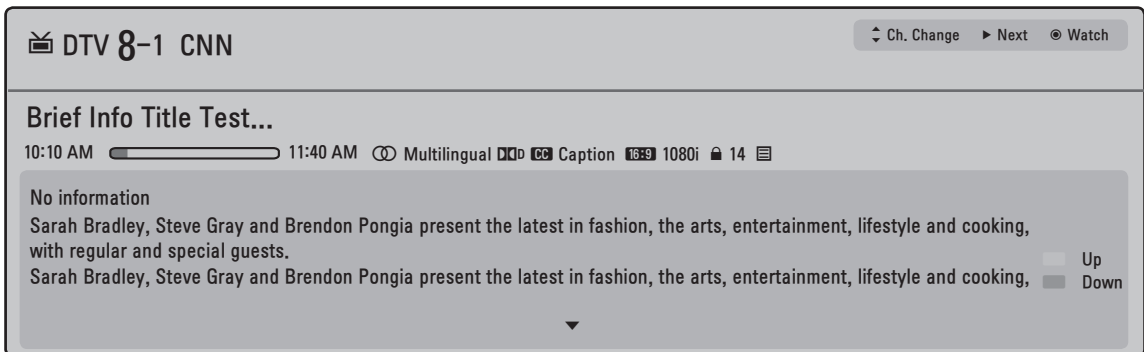

Button	Description
INFO	Shows current channel information.
< or >	Shows previous or next channel information.
^ or v	Changes a channel.

Channel Program Reservation

- 1 Press **INFO** to view the current channel program Information on the screen.
- 2 Press the **>** button to select a next channel program information and press **OK**.
- 3 Press the **<** or **>** buttons to scroll to **Yes** or **No** and press **OK**.

EPG (Electronic Program Guide) (In digital mode)

This system has an Electronic Program Guide (EPG) to help your navigation through all the possible viewing options.

The EPG supplies information such as program listings, start and end times for all available services. In addition, detailed information about the program is often available in the EPG (the availability and amount of these program details will vary, depending on the particular broadcaster). This function can be used only when the EPG information is broadcast by broadcasting companies.

The EPG displays the program details for next 8 days.

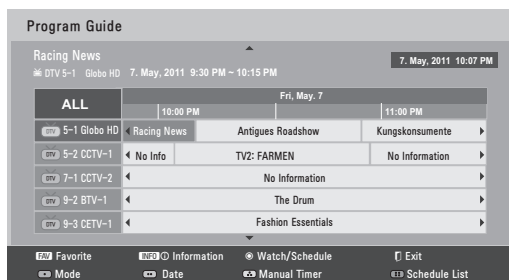

NOW/NEXT Guide Mode

You can view a program being broadcasted and one scheduled to follow.

Button	Description
Red	Changes EPG mode.
Yellow	Enters Manual Timer mode.
Blue	Enters Schedule List mode.
OK	When 'Now' is selected, it is moved to selected program and EPG disappears When 'Next' is selected, a reservation pop-up window appears.
< or >	Selects NOW or NEXT Program.
^ or v	Selects the Broadcast Program.
PAGE (^, v or +, -)	Page Up/Down
GUIDE	
↩ (BACK)	Switches off EPG.
EXIT	

8 Day Guide Mode

Button	Description
Red	Changes EPG mode.
Green	Enters Date setting mode.
Yellow	Enters Manual Timer mode.
Blue	Enters Schedule List mode.
OK	When 'Currently broadcasting program' is selected, it is moved to selected program and EPG disappears. When 'Future broadcasting program' is selected, a reservation pop-up window appears.
< or >	Selects Program.
^ or v	Selects the Broadcast Program.
PAGE (^, v or +, -)	Page Up/Down
GUIDE	
↩ (BACK)	Switches off EPG.
EXIT	

Date Setting Mode

Button	Description
Green	Switches off Date setting mode.
OK	Changes to the selected date.
< or >	Selects a date.
^ or v	Switches off Date setting mode.
PAGE (^, v or +, -)	Page Up/Down
GUIDE	
EXIT	Switches off EPG.

Detailed Information Box

Button	Description
< or >	Selects Remind setting mode.
^ or v	Text Up/Down
PAGE (^, v or +, -)	Page Up/Down
GUIDE	
EXIT	Switches off EPG.

Manual Timer Mode

Button	Description
Yellow	Changes to Guide mode.
Blue	Changes to Schedule List mode.
OK	Sets Timer Watch.
<, >, ^, v	Selects date.
GUIDE	Changes to Guide mode.
↵ (BACK)	Exits Manual Timer mode.
EXIT	

Schedule List Mode

If you've created a schedule list, a scheduled program is displayed at the scheduled time even when you are watching a different program at the time.

Button	Description
Yellow	Changes to Manual Timer mode.
Blue	Changes to Guide mode.
OK	Selects your desired Option (Modify/Delete/Delete All).
^ or v	Selects Schedule List.
PAGE (^, v or +, -)	Page Up/Down
↵ (BACK)	Switches off Schedule List.
EXIT	

Using additional options

Adjusting aspect ratio

Resize an image to view at its optimal size by pressing **RATIO** while you are watching TV.

! NOTE

- You can also change the image size by pressing **Q. MENU** or accessing **Aspect Ratio** in the **PICTURE** menu.
- The available ratio varies depending on the input source.
 - The input sources: HDMI-PC and RGB-PC support 4:3 and 16:9.
 - The input sources: HDMI-PC 1920 X 1080 supports all of the aspect ratios.

- 16:9:** Resizes images to fit the screen width.



- Just Scan:** Displays video images in the original size without cutting off the edges.

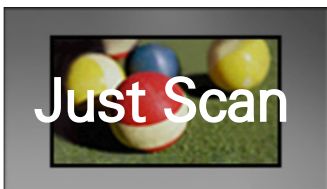

! NOTE

- If you select **Just Scan**, you may see image noise at the edges of the screen.
- The input sources: DTV, Component, HDMI-DTV, and DVI-DTV (720p/1080i/1080p) support Just Scan.

- 4:3:** Resizes images to the previous standard 4:3.



- Set By Program:** Displays images in the same aspect ratio as the original image.

(4:3 → 4:3)



(16:9 → 16:9)

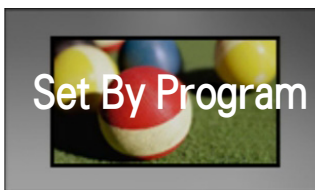

- Zoom:** With this function, when the SD screen is sent to the HD with black at the left side and the right side, this screen can be extended to be fully displayed with no black area. It is enabled at the HD (DTV, Component, HDMI) input (It is the reference for displaying 'HD' at the channel banner if the height is greater than 480).



- **Cinema Zoom:** Formats an image to the cinemascope ratio, 2.35:1.
 - To change the ratio of the cinema zoom, press < or > and its range is from 1 to 16.
 - To move the zoom focus up or down, press ^ or v.



! NOTE

- If you enlarge or reduce an image, the image may be distorted.

Changing AV modes

Each **AV mode** has optimized image and sound settings.

Press **AV MODE** repeatedly to select an appropriate mode.

Mode	Description
Off	Changes to the previously customized settings .
Cinema	Uses the optimized image and sound settings for a cinematic look.
Game	Uses the optimized image and sound settings for fast gaming. When playing a video game using PlayStation or Xbox, it is recommended to use the Game mode. When in Game mode, functions related to picture quality will be optimized for playing games.

Using the input list

Selecting an input source

- 1 Press **INPUT** to access the input sources.
 - The connected device displays on each input source.

! NOTE

- You can also access the input source list by selecting **INPUT** in the **SETTINGS** menu.

- 2 Press the Navigation buttons to scroll to one of the input sources and press **OK**.

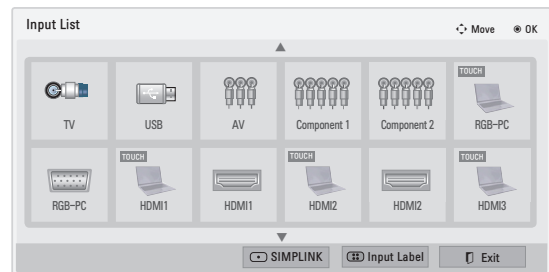

Input source	Description
TV	Watch TV over the air, cable, and digital broadcast.
USB	Play media files from a thumb drive.
AV	Watch video from a VCR or other external devices.

Component	Watch video from a DVD or other external devices, or through a digital set-top box.
RGB-PC (TOUCH)	Use the TV as a computer monitor. (For Pentouch TV)
RGB-PC	Use the TV as a computer monitor.
HDMI (TOUCH)	Watches video from a HTS or other high definition devices. (For Pentouch TV)
HDMI	Watches video from a HTS or other high definition devices.

- The disconnected input sources will be gray.
- To add an input label, press the **Blue** button. You can easily identify a device connected to each input source.
 - If you connect a new external device to the TV, a pop-up window appears. Select Yes on the pop-up window to switch to that input source.
 - To access the SIMPLINK, press the **Red** button. If you select "SIMPLINK and On", the pop-up window for the HDMI input will not display.

Adding an Input label

Add a label to an input source so that you can easily identify a device connected to each input source.

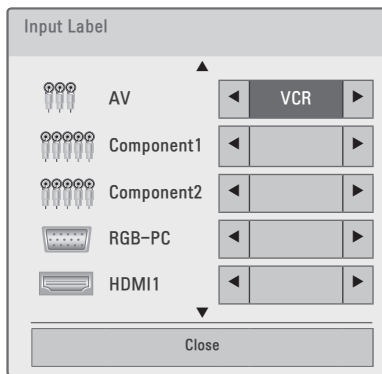

- 1 Press **INPUT** to access the input sources.
- 2 Press the Navigation buttons to scroll to one of the input sources.
- 3 Press the **Blue** button.
- 4 Press the Navigation buttons to scroll to one of the input labels and press **OK**.

- 5 When you are finished, press **EXIT**. When you return to the previous menu, press **↩ (BACK)**.



NOTE

- This function is not supported in Pentouch mode.

Locking the buttons on the TV (Child Lock)

Lock the buttons on the TV to prevent any unwanted operations or accidents by children.

- 1 Press **SETTINGS** to access the main menus.
- 2 Press the Navigation buttons to scroll to **LOCK** and press **OK**.
- 3 Input password.
- 4 Press the Navigation buttons to scroll to **Key Lock** and press **OK**.
- 5 Select **On** to activate the **Key Lock** feature.
 - To deactivate the **Key Lock** feature, select **Off**.
- 6 When you are finished, press **EXIT**. When you return to the previous menu, press **↩ (BACK)**.



NOTE

- The TV is programmed to remember the last setting after you turn the TV off.
- If you turn the TV off with the Key lock feature activated, **⏻**, **INPUT**, **CH** (**▲**, **▼** or **+**, **-**) or Number buttons on the remote control.
- If you press any button on the TV with the **Key Lock** feature activated, **⚠ Key Lock** appears on the screen.

Using the quick menu

Customize frequently used menus.

- 1 Press **Q. MENU** to access the quick menus.
- 2 Press the Navigation buttons to scroll through the following menus.

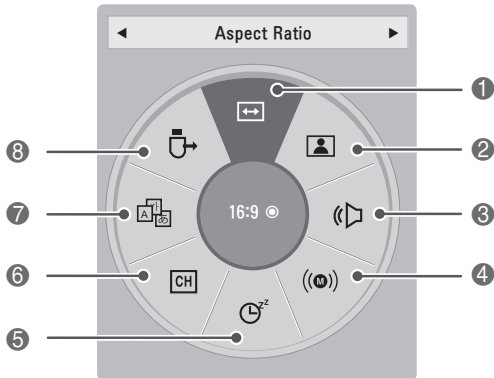

Menu	Description
① Aspect Ratio	Changes the image size.
② Picture Mode	Changes the image mode.
③ Sound Mode	Changes the sound mode.
④ Multi Audio	Changes the audio language (Digital signal).
	SAP Changes the MTS sound (Analog signal).
⑤ Sleep Timer	Sets the length of time until the TV to turns off.
⑥ Del/Add	Edits the channels to add or delete the channel.
⑦ Caption	Activates or deactivate the subtitles.
⑧ USB Device	Ejects a USB device when a USB device is connected.

NOTE

- The available menus and options may differ from the input source that you are using.

- 3 Press the Navigation buttons to scroll to the option you want.
- 4 When you are finished, press **Q. MENU**.

Using the customer support

Testing the Picture / Sound

To execute picture and sound tests:

- 1 Press **SETTINGS** to access the main menus.
- 2 Press the **Red** button to scroll **Customer Support**.
- 3 Press the Navigation buttons to scroll **Picture Test** or **Sound Test** and press **OK**.
- 4 If you have any problem, press the Navigation buttons to scroll to **Yes** and press **OK**.
- 5 When you are finished, press **EXIT**.
When you return to the previous menu, press **↩ (BACK)**.

Using the product or service information

To check the product or service information:

- 1 Press **SETTINGS** to access the main menus.
- 2 Press the **Red** button to scroll **Customer Support** and press **OK**.
- 3 Press the Navigation buttons to scroll **Product/Service Info..**
You can check the various product/Service information based on your model.
- 4 When you are finished, press **EXIT**.
When you return to the previous menu, press **↩ (BACK)**.

PENTOUCH (FOR PENTOUCH TV)

Using Pentouch

Pentouch allows you to use touch pen supported features like Sketchbook, Photo Editor, Family Diary, Gallery, Internet and My Office.



WARNING

- Do not drop or throw the touch pen and cradle. Do not swing the touch pen and cradle with the charging cable connected to it. This can damage the product or cause personal injury.
- For people using pacemakers, the distance between the touch pen and the pacemaker should be at least 30 cm. Never use it where wireless communication is prohibited. Protect it from extreme vibrations or magnetic objects. Wireless communications can cause malfunctions or failures.
- Do not use or store the touch pen and cradle in direct sunlight, near a hot object (e.g., a heater or fireplace), or in dusty or high-humidity environments. This can result in product deformation, malfunction, failure, or fire.
- If abnormal sound, smoke, or odor is detected, immediately remove the charging cable and stop using the product. Contact a service center. This can cause failures or fire.
- If fluid leaks from the touch pen and cradle, do not touch the fluid with bare hands. If fluid comes into contact with eyes, immediately rinse eyes with abundant tap water, then consult a doctor. The fluid can cause blindness. If the fluid comes into contact with skin or clothing, immediately wash it off with tap water. If the fluid causes skin inflammation or injury, consult a doctor.
- Do not allow the fluid to come into contact with fire. Do not heat the product in a microwave or convection oven.
- Use the specified USB cable when charging the battery.
- Keep the touch pen and cradle out of reach of children and away from unstable locations. Do not let children or pets put the touch pen and cradle in their mouths or lick the touch pen and cradle. Playing with or swallowing it may cause serious injury.

- Do not use the touch pen and cradle with wet hands. Do not let foreign substances (e.g., soft drinks or water) enter the touch pen and cradle; if this happens, do not use the touch pen and cradle. Do not touch the optic receiver of the touch pen and cradle with a sharp object. This can result in electrical shock or damage the product.
- Do not use the product under extreme temperature conditions. Do not use the product immediately after going from the cold outdoors to the warm indoors. This can cause condensation in the pen. This can result in damaging the product. Turn off the power and wait several hours until the moisture evaporates before using the product.
- Never disassemble or modify the touch pen and cradle. The product warranty does not cover damage or injury caused by unauthorized disassembly. This can result in electrical shock or damage the product.
- If fluid leaks from the touch pen and cradle, the use of fire in the vicinity is strictly prohibited. The leaked fluid or gas can be flammable.
- Avoid extreme shocks or impacts to the product, for example, placing a heavy object on it or pressing it.
- Do not display fixed characters or images on the screen for extended periods of time. This can cause image sticking.
- Do not connect the charging cable to peripheral devices or disks that are not specified. This can cause malfunctions or failures.
- Do not leave the touch pen and cradle on the floor. Stepping on it can damage the product or cause personal injury.
- Be careful when disposing of the product. The touch pen and cradle consists of a lithium-polymer battery and plastic material. Burning can be dangerous, so dispose of it according to local regulations.
- Do not remove the charging cable using excessive force. This could damage the charging port and PC.
- Do not handle the touch pen and cradle with excessive force. If you use the touch pen and cradle with excessive force, you may leave foreign substances on the screen. Clean the product with the product cleaning cloth provided.
- When multiple people use the touch pen and cradle, make sure that sufficient space is available. Collisions can cause injury or failures.

Step of using the Pentouch Program

Follow the steps below to use the Pentouch function.

- 1 Check the system requirements before installation.
- 2 Install the Pentouch program from the installation CD.
- 3 Pair the pen and the dongle.
- 4 Connect the PC and the TV.
- 5 Configure the PC screen.
- 6 Activate the Pentouch mode on the TV.
- 7 Start the Pentouch program.

System Requirements

Make sure that the programs is installed properly to allow proper operation of the touch pen.

Supported Operating System	
Windows XP	32 bit
Windows Vista, Windows 7	32 bit 64 bit

(Windows 7 Starter Edition is not supported.)

Recommended System Requirements for Pentouch

- CPU: Dual-Core 2GHz or better
- Memory: 1GB or more
- HDD: 500MB or more
- Display: Graphics card with 1024 x 768 via an RGB or HDMI output port
- Windows 7 is recommend due to its support of multi-touch.

! NOTE

- You must log in as an administrator to install or remove the program.
- Make sure to install the program found on the CD provided.
- You can also download this program from the LG Electronics website.
- Make sure to close all running applications before installing the program.
- Remove old version of the Pentouch program installed on your PC before re-installing or installing new version.

Installing the Pentouch Program

Follow the steps described in this manual to install the program.

- 1 Prepare your computer and start it.
- 2 After the computer starts, insert the CD provided. The installation screen appears automatically.
(If the installation screen is not displayed automatically, access My computer and then click LG and index.htm to view the installation screen.)
- 3 Click [Install the Pentouch Program] in the installation window.
The default folder is used for installation. A window appears to indicate that the installation was completed successfully.
- 4 In Windows XP, the [Found New Hardware Wizard] installs your program automatically.
- 5 Restart your computer after the installation.

! NOTE

- Disconnect the USB dongle first to install the program.

Removing the Pentouch Program

If there is a problem with the Pentouch program or an error occurs while using the program, follow the steps below to remove the program, and then reinstall them.

- 1 On your computer, select [Start] → [Control Panel] → [Add/Remove Programs] to remove the Pentouch program.
- The installed Pentouch program: LG Pentouch TV
- 2 Click [Yes]. A window appears telling you that the program has been removed.
- 3 Please reboot your PC after removing the program.

Pairing between Touch Pen and Dongle

What is Pairing?

You need to pair the touch pen and the dongle before using the touch pen. Once paired, you do not need to pair them again unless you:

- Bought a new pen
- Replaced the old pen with a new one
- Attempt to pair a new touch pen for using two pens simultaneously

Things to Know Before Pairing

- This program allows pairing of up to two pens and one dongle.
- If you want to use two pens simultaneously, they must be paired with your dongle one at a time.
- Pairing is not possible if a paired pen is currently in use.
- If you pair a new touch pen when two pens have already been paired with your dongle, all the previous pairing data is deleted.

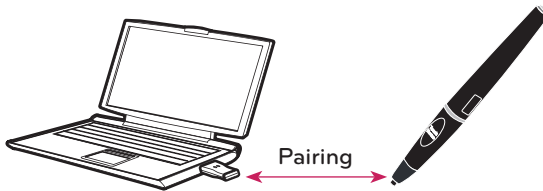

Touch Pen

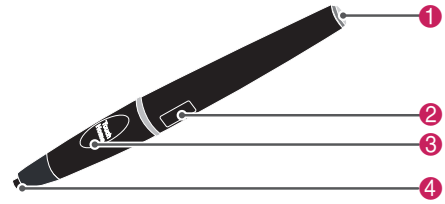

No.	Description
①	Power button / LED indicator
②	USB charging port
③	Touch Home button
④	Touch pen tip switch

Cradle

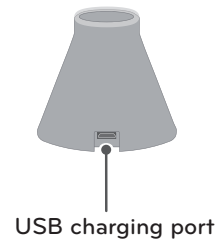

Dongle

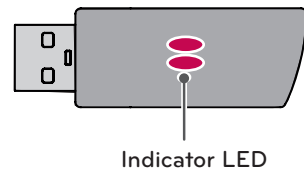

! NOTE

- For more information, please refer to the user manual (Touch Pen, Dongle).
- Touch pens, cradles and dongles are sold separately at dealers.
- When you leave your touch pen unused for a certain period of time (10 minutes), the pen automatically powers off.

Pairing for the First Time

- 1 Check that the LED indicator on the dongle connected to the computer is red.
- 2 Keep the touch pen within 30 cm of the dongle.
- 3 Press the  (**POWER**) button on the touch pen once.
- 4 The LED indicator on the touch pen will red for 2 seconds and blinks green 3 times when pairing is complete.
- 5 If the LED indicator is red for 4 - 5 seconds and blinks red 3 times, pairing is not successful. Please try pairing again.
- 6 Once a pen is paired, the red LED blinks once when you press the **Touch Home** button.

When Pairing Fails

- 1 Pairing fails if the dongle driver is not installed on the computer.
- 2 Pairing fails if the LED indicator on the dongle is not red.
- 3 Remove the dongle from the PC, reinsert it and try pairing.

Unpairing (Resetting the touch pen)



- 1 Press the **Touch Home** button on the touch pen and check that the red LED blinks once.
- 2 Press the **Touch Home** button and the  (**POWER**) button together, regardless of sequence, for more than 4 seconds.
- 3 If you release the buttons after 4 seconds, the pen will be reset. The red LED will blink three times and the pen will be turned off.

Caution When Unpairing

- 1 Be careful not to unpair the pen by mistake. If unpaired, try pairing it again.
- 2 If you unpair and pair a normally functioning touch pen, the other paired pen may not work. In this case, unpair the nonfunctioning touch pen and pair it again by following the steps described in the Pairing for the First Time section.

Touch pen Operation

Once paired, you can use the touch pen in the following ways.

- 1 Powering on
 - Press the  (**POWER**) button once. The red and green LEDs will remain lit to indicate that the power is on.
- Powering off
 - Press the  (**POWER**) button for more than 3 seconds and release it. The red LED will blink 3 times and the pen will be turned off.
- 2 Pressing the **Touch Home** button while using the touch pen
 - In the Pentouch program: Shows or hides the toolbar of the feature.
 - In Windows: Works in the same way as the right-click function. Point the touch pen at an object you want to right-click, then press the button.
- 3 The double-click function may not work as intended in Windows XP or Windows Vista. If this is the case, use the **Touch Home** button (right-click) instead.
- 4 The touch pen works in the same way as a mouse in Windows.

Tip replacement

- 1 Detach the tip holder and the tip to be replaced from the pen.

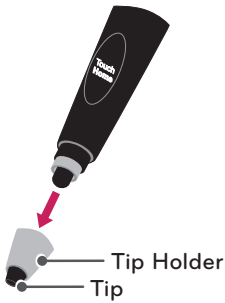

- 2 Insert a new tip into the detached tip holder and assemble the tip holder with the pen.

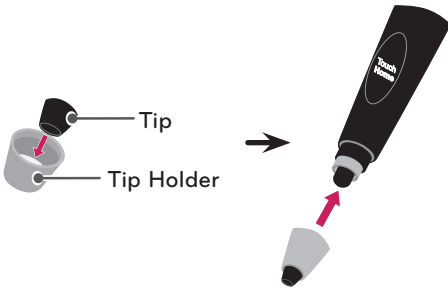

Charging the touch pen

- Charging on the cradle

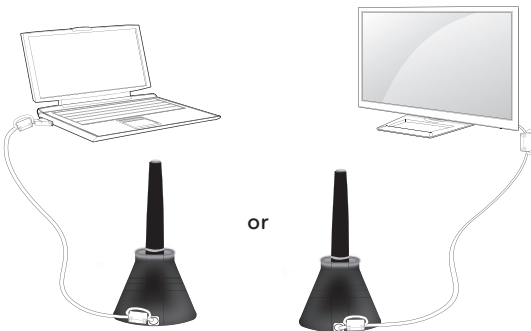

- Charging directly

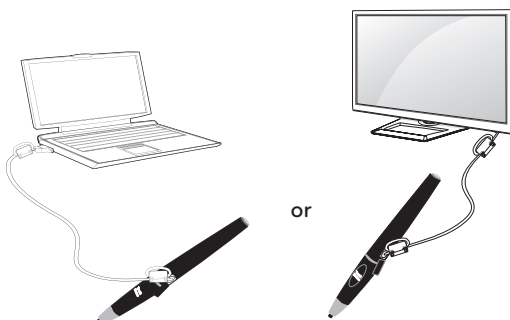

! NOTE

- After an hour and 30 minutes of a continuous charge, you can use the touch pen for about 2 hours.
- Pentouch operation may not be normal while charging.
- Green LED will be turned on during using touch pen. If you don't use touch pen, it will be automatically turned off after 10 minute.
- Touch pen LED indicator for battery status
 - Charging: Red LED
 - Charging complete: Green LED
 - No battery power: Red LED blinks every second and powers off automatically.
 - LED ON Sleep mode: If no switch (tip switch, function key, power key) is pressed for 10 seconds, the device enters sleep mode but the LED stays green.
 - LED OFF Sleep mode: If there is no input for one minute after entering LED ON Sleep mode, the LED is turned off and the device enters LED OFF Sleep mode.
 - Power off mode: The device is powered off if there is no input for nine minutes after it has been in sleep mode for one minute.
- If you connect the pen to the TV to charge, the TV should be powered on for normal charging.

Using the Pentouch Function

You need the following items to use the Pentouch functions:

- Computer with RGB or HDMI output
- RGB or HDMI cable

- 1 After connecting the TV and the PC with an RGB cable or an HDMI cable, use the **INPUT** button on the remote control and select the input connected to the PC.
- 2 Configure your PC screen by referring to the Display Resolution Setting for Pentouch section. If your PC is a notebook computer, you should configure the video to only be displayed on the TV and not on the PC screen.
- 3 Enter the Pentouch mode on your TV.
 - Press **INPUT** button on the remote control or **SETTINGS** to access the main menus. Then press the navigation buttons to scroll to **Pentouch** and press **OK**.
- 4 Select the correct computer input connection to enter the Pentouch mode.

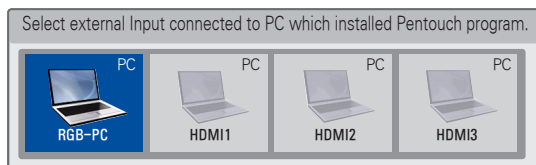

- 5 Use the touch pen or the mouse to start the Pentouch program. Pressing the **Touch Home** button on the touch pen works in the same way as right-clicking the mouse.

NOTE

- If you turn off the TV and turn it back on while using the Pentouch function, the last screen on which you were working appears.
- To switch from Pentouch mode to others mode, either press the **INPUT** button on the remote control to select the desired input or press the **TV** button to return to the TV viewing screen.

Display Resolution Settings for Pentouch

On a Desktop Computer

In Windows XP

Right-click the desktop and select [Properties]. In the [Display Properties] window, set the screen resolution to 1024 x 768 under the [Settings] tab.

In Windows Vista

Right-click the desktop and select [Personalize] and [Display Settings]. Set the screen resolution to 1024 x 768 in the [Resolution] section.

In Windows 7

Right-click the desktop and select [Screen Resolution]. Set the screen resolution to 1024 x 768 in the [Resolution] section.

On a Laptop Computer

Method 1:

On your laptop, press the "Fn + switch screen" key on the keyboard to display the computer screen on your TV screen, then set the computer's display resolution to 1024 x 768 .

* Note: The switch screen key of the laptop may be subject to change by the manufacturer.

LG	Samsung	HP	Toshiba
Fn+F7	Fn+F4	Fn+F5	Fn+F5
Sony	Acer	Dell	Lenovo
Fn+F7	Fn+F5	Fn+F8	Fn+F7

Method 2:

Open the control panel for the graphics card on your computer.

Set [Display Mode] to the [Single Display] mode, then select [LG TV] as the display to use.

* Set the computer's display resolution to 1024 x 768.

**NOTE**

- The method of changing display resolution settings may vary according to the computer's configuration.
- Pentouch does not support dual monitor mode or duplicate (mirror) monitor mode. Check that the PC screen is set to only be displayed on the TV.
- The switch screen key of the laptop may be subject to change by the manufacturer.

**CAUTION**

- The double-click function may not work as intended in Windows XP and Vista because these operating systems do not use touch drivers.
- The Pentouch operation may become slow depending on the computer's performance.
- The screen size may change if you disconnect the computer's output port and connect it again. If this happens, set the computer resolution again.
- If nothing is shown on the TV and the laptop screen when you press the switch screen key (Fn + manufacturer-specified key), try pressing the key again.
- The TV screen size may become smaller when you press the switch screen key (Fn + manufacturer-specified key). If this happens, adjust the resolution again.
- Changing the desktop icon properties in Windows 7 may affect the Pentouch program.
- It is recommended not to run other applications while using the Pentouch program.
- If the point you touch on the TV screen using the touch pen and the point indicated as touched on the computer screen do not match when the computer and TV are connected by a PC signal (RGB) cable, use the TV remote control to select [SETTINGS] → [Picture] → [Screen] (RGB-PC), then select [Auto Config.] to adjust the screen.

- If the PC and TV are only connected by a PC (RGB) signal cable, there will be no sound from the TV. Please connect the PC and the TV with a PC audio cable as well.
- The Play Video function in Photo Editor may not work as intended, depending on the codecs installed on your computer.
- Eraser function could be slower if drawing objects are overlapped exceed program performance depends on PC environment.
- If you want to open programs with a single click in Window XP or Vista, on your PC, go to Start → Control Panel → Folder Options and select "Single-click to open an item (point to select)".
- If your PC is running Windows XP, the virtual keyboard will only support English.
- When changing to the Pentouch mode, or when changing the resolution in Pentouch mode for RGB input signals, images may not be displayed properly for a while due to auto adjustment.
- Metal obstacles between the Pen and the Receiver can cause interference. Move the receiver to a different location if you experience communication problems with the Pen.
- The Pentouch function may not work normally where the TV screen is too bright due to light from another light source.

Checking the Pentouch Functions

You see the home screen shown below when you start the Pentouch.

- 1 Press **INPUT** button on the remote control or **SETTINGS** to access the main menus. Then press the navigation buttons to scroll to **Pentouch** and press **OK**.
- 2 Touch the screen with the touch pen to select **Sketchbook**, **Photo Editor**, **Family Diary**, **Gallery**, **Internet** or **My Office**.

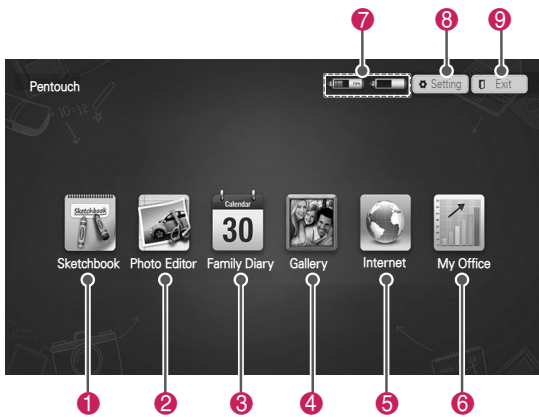

When you select the **Setting**

- 1 Select **Setting** from the Pentouch Home screen with the touch pen.
- 2 Select the desired option.

Option	Description
Open folder	Select a folder from which you will open photos or video files.
Save folder	Select a folder to which you want to save images.
Screensaver	Select the standby time for the screensaver.
Language	Select and change the language you wish to work in.

No.	Description
1	Sketchbook Select the background you want, then draw pictures on it.
2	Photo Editor Draw or edit pictures on photos and videos.
3	Family Diary A journal of photos, videos, notes, and sketches for family events by date.
4	Gallery A collection of pictures drawn and saved in Sketchbook, Photo Editor, Internet, and My office.
5	Internet Launch the web browser to capture the web content, then draw or write memos on it.
6	My Office Supports the glass effect in Microsoft Office and PDF files.
7	Touch pen battery level
8	Saving, opening folder location, screen saver settings and selecting language
9	Quit the Pentouch program

Using Toolbar

You can use the draw toolbar on all menu screens. Display the toolbar by pointing the touch pen at the bottom of the screen.

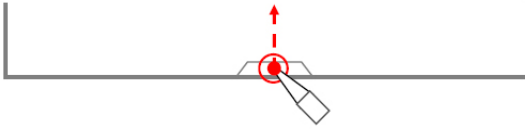

There are two types of toolbars: fixed and specialized.

- The fixed toolbar provides the functions used for all menus.
- The specialized toolbar provides the functions used for a specific menu.

Fixed Toolbar Functions

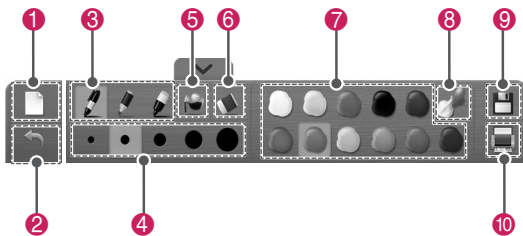

No.	Description
①	Remove the background and all the drawings.
②	Undo up to 5 recent actions.
③	Ink pen, highlighter pen, magic pen.
④	Select the thickness of the current drawing tool.
⑤	Fill a closed area with the selected color.
⑥	Eraser
⑦	Select a color for the current drawing tool.
⑧	Select any color from the color wheel.
⑨	Save
⑩	Print

* Descriptions for the specialized toolbar functions are provided in the menu function description section.

Using Sketchbook

You can select the background you want, then draw pictures on it.

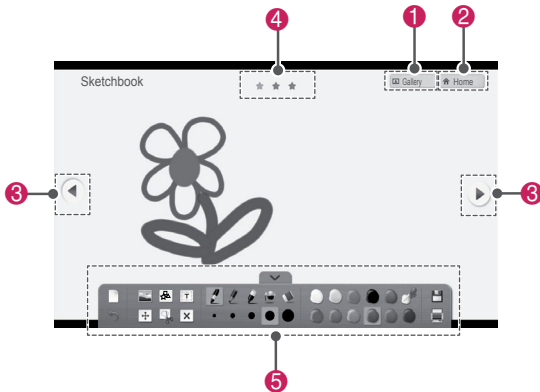

- 1 Touch the screen with the touch pen to select **Sketchbook**.
- 2 Touch the screen with the touch pen to select the desired option or use the toolbar to draw a picture.

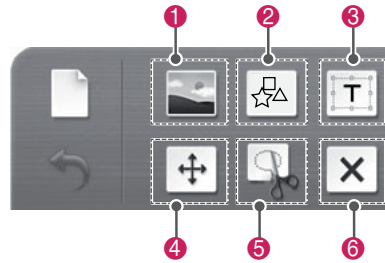

No.	Description
1	Enter Gallery.
2	Enter the Pentouch Home menu.
3	Select them to go to the previous page or next page. You can move up to 3 pages.
4	Current page position
5	Toolbar functions

Specialized toolbar functions

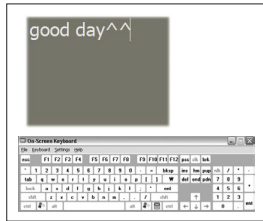

No.	Description
1	Select image for background. 
2	Insert basic figures. Select the desired icon, then short tap to create a default size figure. 
3	Insert text. If you select an area to enter the text, a keyboard will be displayed on the screen. 
<p>NOTE</p> <ul style="list-style-type: none"> For some operating systems, two virtual keyboards may be displayed. 	

When dragging a line, pen or shape, you can only move or resize a single object at a time. If you short tap an object and drag, the area of the selected object will be displayed.

Move

You can move an object by dragging the area of the selected object.

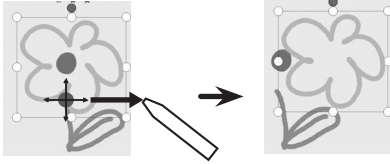

Expansion / Reduction

You can expand or reduce an object by dragging one of the 8 corners of the selected object. The object will be resized based on the corresponding corner/edge.

4

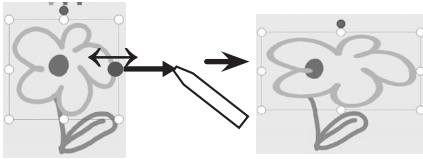

Rotation

Drag in rotation to rotate the selected object.

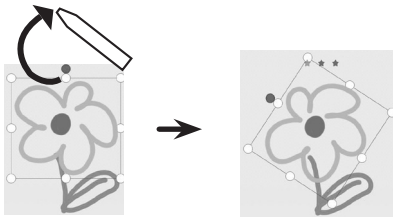

Cut the range and Move / Expansion / Reduction / Rotation.

5

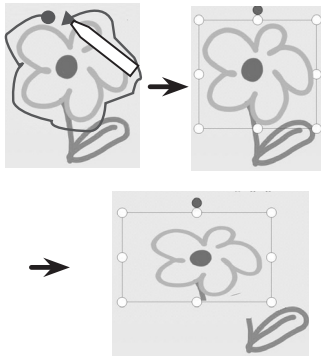

Delete object from the screen.

6

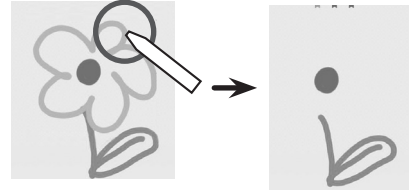

Using Photo Editor

You can draw on or edit images and video.

- 1 Touch the screen with the touch pen to select **Photo Editor**.
- 2 Touch the screen with the touch pen to select the desired option.

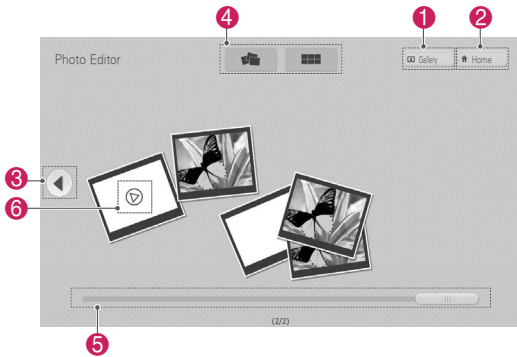

No.	Description
1	Enter Gallery.
2	Enter the Pentouch Home menu.
3	Select them to go to the previous page or next page.
4	Select photo list view option. (Scattered view / Sorted view)
5	Page navigation scrollbar
6	Only one video can be played at a time; the previously playing video is paused.

- 3 Select the photo or video you wish to decorate. You can decorate the picture with the toolbar.

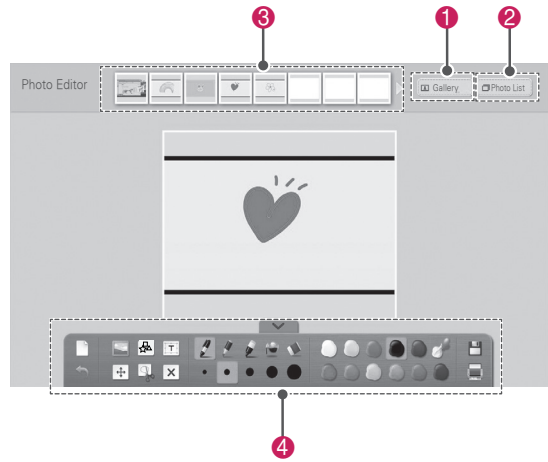

No.	Description
1	Enter Gallery.
2	Open Photo list.
3	Previews of all photos and videos in the folder are shown here. (from new to old)
4	Toolbar functions



NOTE

- When working with a video, you can use the pause button and extract the image of the paused frame to use it in Photo Editor.
- You can edit the photos or videos stored in the Photo List.
- The TV may not properly play the video files in the Pentouch mode depending on your computer.

Specialized toolbar functions

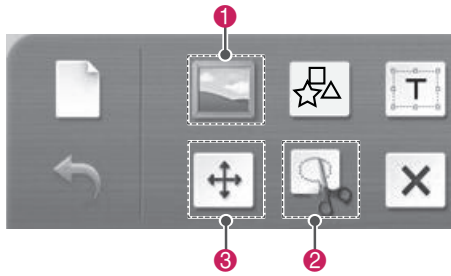



No.	Description
<p>1</p>	<p>Frame for image.</p>
<p>2</p>	<p>Cut from the image.</p> <p>After select area to cut, you can change it's size.</p>

3

Move an object.

If you select an object, a mini pop-up window will display.

-  Bring to Front
-  Send to Back
-  Delete

Using Family Diary

You can keep a journal of photos, videos, notes, and sketches for family events by date.

- 1 Touch the screen with the touch pen to select **Family Diary**.
- 2 Select the desired date with the touch pen.

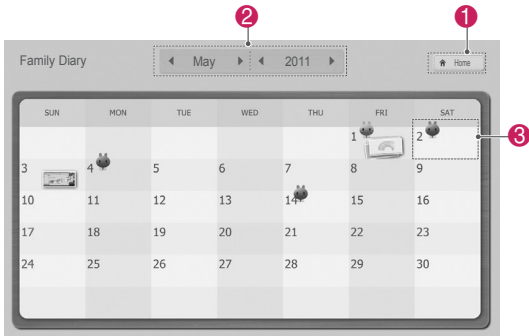

- 3 Use the toolbar to create and decorate the family diary.

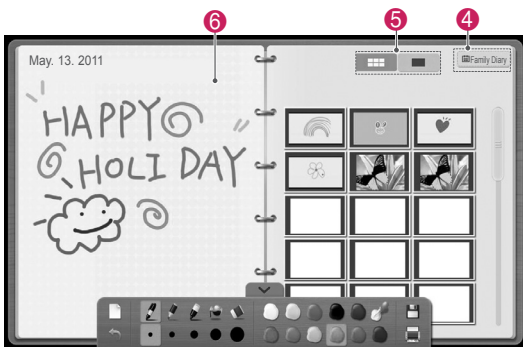

No.	Description
1	Enter the Pentouch Home menu.
2	Select date.
3	Dates with images are shown with icons. Select a date with images to see the screen.
4	Open the Family Diary screen.
5	Select Preview or Full Screen.
6	Draw or write here.

Using Gallery

This is the gallery of the images you made and saved using Sketchbook, Photo Editor, Internet, and My office.

- 1 Touch the screen with the touch pen to select **Gallery**.
- 2 Touch the screen with the touch pen to select the desired option, and enjoy the Gallery screen.

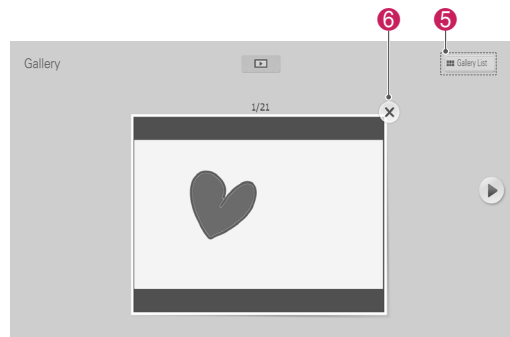
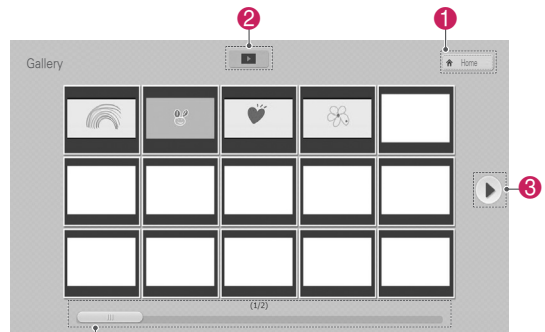

No.	Description
1	Enter the Pentouch Home menu.
2	Start slideshow from the first image on the current page. To stop the slide show, touch the screen while the slide show is playing with the touch pen. This will take you back to the previous screen.
3	Page button: Select them to go to the previous page or next page.
4	Page navigation scrollbar
5	Enter the Gallery List
6	When selected, the current image is deleted and the next image is displayed.

Using Internet

You can capture web content to draw or write memos on it.

- 1 Touch the screen with the touch pen to select **Internet**.
- 2 Touch the screen with the touch pen to select the desired option or use the toolbar.



ENGLISH

No.	Description
①	Enter the Pentouch Home menu.
②	Virtual keyboard tab: Insert text. Select the virtual keyboard tab to display the keyboard on the screen.
③	If you select a pen icon on your TV, the drawing mode will be activated. When you in drawing mode, the virtual keyboard will be hidden.
④	If you select a mouse icon on your TV, the click mode will be activated. Drawings will be cleared when you exit the drawing mode.

Using My Office

You can draw or write in Microsoft Office or PDF files.

Folders and formats supported are displayed below.

Supported file format

Type.	Supported file format
Office Files	2003 version ppt, doc, xls 2007 version pptx, docx, xlsx All Microsoft PowerPoint files (*.ppt, .pptx) All Microsoft Word files (*.doc, .docx) All Microsoft Excel files (*.xls, .xlsx) Outlook data files (*.msg, *.eml)
PDF Files	Adobe PDF files (*.pdf)

- 1 Touch the screen with the touch pen to select **My Office**.
- 2 Touch the screen with the touch pen, then in the Open popup window, select the file to open.
- 3 Touch the screen with the touch pen to select the desired option or use the toolbar.

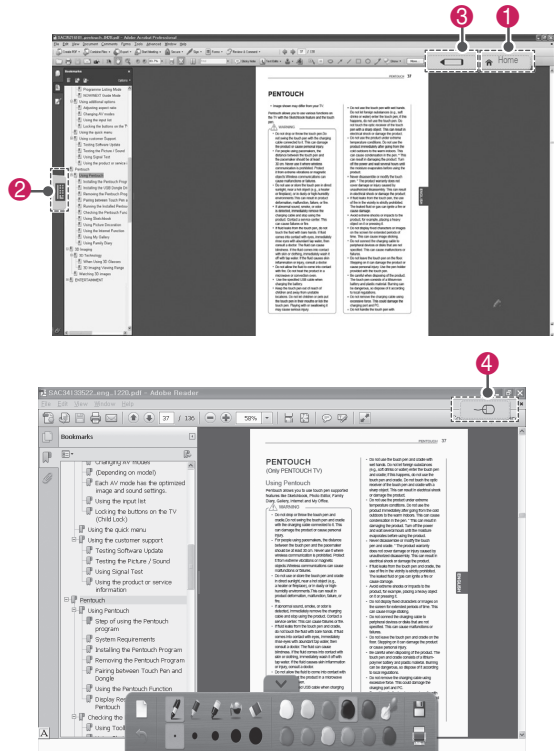

No.	Description
1	Enter the Pentouch Home menu.
2	Virtual keyboard tab: Insert text. Select the virtual keyboard tab to display the keyboard on the screen.
3	If you select a pen icon on your TV, the drawing mode will be activated. When you in drawing mode, the virtual keyboard will be hidden.
4	If you select a mouse icon on your TV, the click mode will be activated. Drawings will be cleared when you exit the drawing mode.



CAUTION

- Applications that support Microsoft Office and PDF files must be installed on your computer.

ENTERTAINMENT

Connecting USB storage devices

Connect USB storage devices such as a USB flash drive or external hard drive to the TV and use multimedia features (See "Browsing files" on p. 51). Connect a USB flash drive or USB memory card reader to the TV as shown in the following illustration.

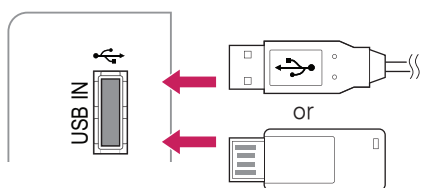

To disconnect a USB storage device, make sure to end the connection properly to prevent damages to the TV or files.

- 1 Press **Q.MENU** to access the quick menus.
- 2 Press the Navigation buttons to scroll to **USB Device** and press **OK**.
- 3 Disconnect the USB storage device only when the message says that it is safe to remove.



CAUTION

- Do not turn the TV off or remove a USB storage device while the USB storage device is connected to the TV, as this could result in loss of files or damage to the USB storage device.
- Back up your files saved on a USB storage device frequently, as you may lose or damage the files and this may be not covered by the warranty.

Tips for using USB storage devices

- The TV recognizes only a USB storage device.
- If you connect a USB storage device to the TV through a USB hub, your TV may not recognize the USB storage device.
- The TV may not recognize a USB storage device that requires a special driver.
- The recognition speed of a USB storage device may differ depending on the device.
- Only use a USB storage device which has normal music or image files.
- Use only USB storage devices that are formatted as a FAT 32 or NTFS file system.
- If you format a USB storage device as a NTFS file system, you cannot delete the saved files.
- You may need to connect a USB storage device to an external power supply with a power adapter.
- If the TV does not recognize a connected USB storage device, replace the cable and try again. Do not use an excessively long cable.
- The TV does not support some USB storage devices properly.
- You can use a multi-partition (up to 4) USB storage device.
- You can use up to 4 USB storage devices at a time by using a USB multi-card reader.
- The file alignment method of a USB storage device is similar to the one of Window XP.
- You cannot create or delete a folder saved in a USB storage device directly on the TV.
- The number of characters for a file name is up to 100 English characters.
- If there are too many folders and files in one folder, it may not operate properly.
- The recommended capacity for a USB external hard disk is 1 TB or less and for a USB storage device is 32 GB or less.
- If a USB external hard disk with the Energy Saving feature does not work, turn the USB external hard disk off and on again to make it work properly. For more information, refer to the user manual of the USB external hard disk.
- USB storage devices below USB 2.0 are supported as well. But they may not work properly in the movie list.
- The electrostatic can cause USB device's malfunction. In this case, USB Device has to be plugged again.

Browsing files

Access the photo, music, or movie lists and browse files.

- 1 Connect a USB storage device.
- 2 Press **SETTINGS** to access the main menus.
- 3 Press the Navigation buttons to scroll to **MY MEDIA** and press **OK**.
- 4 Press Navigation buttons to scroll to **MOVIE LIST**, **PHOTO LIST**, or **MUSIC LIST** and press **OK**.

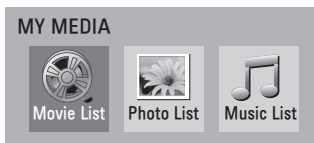

- 5 Select **Drive1** to access the connected USB storage device.
- 6 Press the Navigation buttons to Select a folder/ file you want.

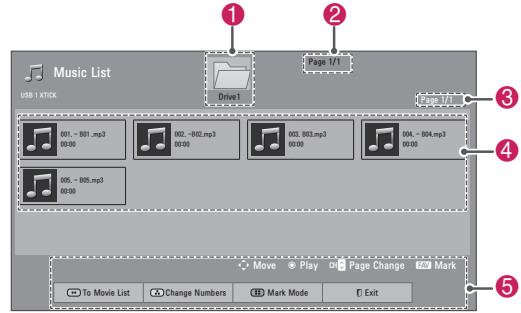

No.	Description
1	Moves to the upper level folder.
2	Current page number/total number of pages
3	Current page number/total number of pages
4	Contents under the folder focused on 1
5	Available buttons on the remote control
Button	Description
Green button	Move to Photo List , Music List , or Movie List .
Yellow button	Change Numbers : Changes the number or thumbnails displayed at a time.
Blue button	Allows you to mark certain files.

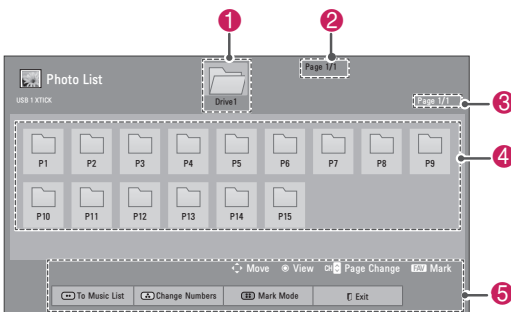
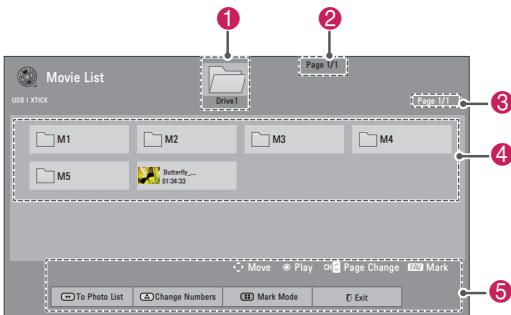

Tips for using USB storage devices

Type	Supported File Formats
Video	<ul style="list-style-type: none"> • MPG, MPEG, DAT, TS, TRP, TP, VOD, MP4, MOV, MKV, DivX, AVI, Motion JPEG (AVI, MP4, MKV), ASF, WMV, FLV • Resolution: under 1920 pixel (width) x 1080 pixel (height) • Frame Rate: under 30 frame/sec (1920 x 1080), under 60 frame/sec (1280 x 720) • Max bitrate of playable movie file: 20 Mbps (Mega bit per second) • Bit rate of audio format: within 32 kbps to 320 kbps (MP3) • Supported subtitle format: *.smi, *.srt, *.sub (MicroDVD, SubViewer 1.0/2.0), *.ass, *.ssa, *.txt (TMPlayer), *.psb (PowerDivX)

Type	Supported File Formats		
Photo	<ul style="list-style-type: none"> • JPG • Available size Baseline: 64 pixel (W) x 64 pixel (H) - 15360 pixel (W) x 8640 pixel (H) Progressive: 64 pixel (W) x 64 pixel (H) - 1920 pixel (W) x 1440 pixel (H) * Do not use the progressive option when saving JPG files on your PC. • It may take some time to open high-resolution images in full screen. 		
	File Extensions	Item	Profile
	jpeg jpg jpe	Supproted file format	<ul style="list-style-type: none"> • SOF0: baseline • SOF1: Extend Sequential • SOF2: Progressive
	Photo size	<ul style="list-style-type: none"> • Min: 64 x 64 • Max - Normal Type: 15360 (W) x 8640 (H) • Progressive Type: 1920 (W) x 1440 (H) 	
Music	<ul style="list-style-type: none"> • MP3 • Bit rate range 32 Kbps - 320 Kbps • Sampling rate (Sampling Frequency) MPEG1 layer 3: 32 kHz, 44.1 kHz, 48 kHz MPEG2 layer 3: 16 kHz, 22.05 kHz, 24 kHz MPEG2.5 layer 3: 8 kHz, 11.025 kHz, 12 kHz * A copy-protected file will not play. 		

Viewing Videos

Your TV can display video files from a USB storage device.

- 1 Press **SETTINGS** to access the main menus.
- 2 Press the Navigation buttons to scroll to **MY MEDIA** and press **OK**.
- 3 Press the Navigation buttons to scroll to **Movie List** and press **OK**.
- 4 Select **Drive1** to access the connected USB storage device.
- 5 Press the Navigation buttons to scroll to a folder/file you want and press **OK**.
- 6 Play a movie by using the following menus/buttons.

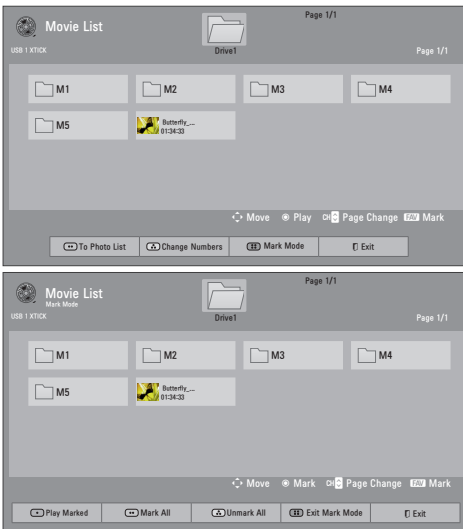

Button	Description
Navigation button	Scrolls through the files.
OK	Plays the highlighted file or enters the mark mode.
CH (▲, ▼ or +, -)	Moves to the previous or next page.
FAV	Enters the mark mode.
Menu	Description
Play Marked	Plays the selected video.
Mark All	Selects all files.
Unmark All	Clears all of your selections.
Exit Mark Mode	Exits the Mark Mode.

NOTE

- : Abnormal files are displayed using this graphic.
- : Non-supported files are displayed using this graphic.

- 7 Control playback by using the following buttons.



Button	Description
■	Stops the playback.
▶	Plays a video.
⏸	Pauses or resumes the playback.
◀	Scans backward in a file.
▶	Scans forward in a file.
⏪ and ⏩	Plays videos in slow motion.
< or >	Skips to specific points in a file during playback. The time of a specific point will appear on the status bar. In some files, this function may not work properly.
ENERGY SAVING	Increases or decreases the brightness of your screen.
Q.MENU	Shows the Option menu (See p.54).
⏮ (BACK)	Hides the menu on screen. To see the menu again, press OK button to display.
EXIT	Moves to the previous menu screen.

Tips for playing video files

- Some user-created subtitles may not work properly.
- Subtitles may not display some special characters or HTML tags.
- Subtitles in the non-supported languages are unavailable.
- The time information in an external subtitle file should be arranged in ascending order to play.

- The screen may suffer from temporary interruptions such as image stoppage or faster playback when you change the audio language.
- If you play a damaged video file, the video file may not be played correctly or some player functions may not be unavailable.
- The TV may not properly play the video files produced with certain encoders.
- If the recorded file does not have video or audio, either video or audio is not outputted
- If the TV plays the recorded file without video or audio, either video or audio is not outputted.
- The TV may not smoothly play the video files with a resolution higher than the supported resolution for each frame.
- The TV may not properly play the video files not included on the specified type and format.
- The TV may not play the files encoded with GMC (Global Motion Compensation) or quarter-pel motion estimation.
- The TV supports the only files saved in ASCII code in subtitles.
- The maximum number of characters displayed on each subtitle line is 250 (Korean), 500 (English), and 500 (Numbers).
- The TV supports the only 10,000 sync blocks within the subtitle file.
- The TV supports the H.264 codec up to the profile level 4.1.
- The TV does not support DTS audio codec.
- The TV cannot play a video file whose size is larger than 30 GB. The file size limit is dependent on the encoding environment.
- If you play a video file through the USB connection that does not support the high speed, the video player may not work properly.
- The TV supports a USB storage device whose version is lower than 2.0. However, the USB storage device may not work properly in the movie list.
- The video file and its subtitle should be in the same folder and the name of the video file and subtitle should be identical.
- You can adjust the image by using **ENERGY SAVING** and **AV MODE**. But you cannot customize image options of each mode.
- The TV may not play the video files in the supported file format depending on the encoded condition.
- The TV will not play the video files that has a damaged index or no index.

Q.MENU options for movie list

- 1 Press **Q. MENU**.
A pop-up window will appear.
- 2 Press the Navigation buttons to scroll to movie list option and press **OK**.
- 3 Press the Navigation buttons to scroll to one of the following options and press **OK**.

Set Video Play.

Option	Description	
Picture Size	Selects your desired picture format for videos. <ul style="list-style-type: none"> • Full Mode: Files are played in full screen mode according to the aspect ratio of video. • Original Mode: Files are played in their native size. 	
Audio Language	Changes the Language Group of the audio for video files. Files with a single audio track cannot be selected.	
Subtitle Language	The subtitles can be turned on or off.	
Language	Activated for SMI subtitles and can select the language within the subtitle.	
Code Page	Subtitle font selection. When set to default, contents are displayed in the language set in "Option - Language - Menu Language."	
	Subtitle Language Group	Supported Language
	Latin1	English, Spanish, Portuguese
Sync	If the video is not synchronized with the captions, it can be adjusted by 0.5 second.	
Position	Moves the location of the subtitles.	
Size	Changes the subtitle font size.	
Repeat	Turn on/off repeat function of movie playback. When turned on, the file within the folder will be played back repeatedly. When turned off, if the next file name is similar to the previous file, it can be played sequentially.	

 **NOTE**

- When replaying a video file after stopping, select “Yes” to restart where it previously stopped.
- If continuous series files exist within the folder, the next file will automatically be played. But, this excludes cases when the Repeat function of Movie List Option is turned “On” (See p.54) or when set as **Play Marked**.

Set Video.

Allows you to change Video presets. (Refer to “PICTURE Settings” on p.62).

Set Audio.

Allows you to change Audio presets. (Refer to “AUDIO Settings” on p.65).

DivX® VOD Guide

DivX® VOD Registration

In order to play purchased or rented DivX® VOD contents, you should register your device with 10 digit DivX registration code from your device at www.divx.com/vod.

- 1 Press **SETTINGS** to access the main menus.
- 2 Press the Navigation buttons to scroll to **MY MEDIA** and press **OK**.
- 3 Press the **Blue** button.
- 4 Press the Navigation buttons to scroll to **DivX VOD Registration** and press **OK**.
- 5 View the registration code of your TV.

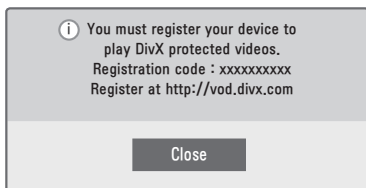

- 6 When you are finished, press **OK**.

NOTE

- While you are checking the registration code, some buttons may not work.
- If you use the DivX registration code of another device, you cannot play the rented or purchased DivX file. Make sure to use the DivX registration code assigned to your TV.
- The video or audio files that are not converted by the standard DivX codec may be corrupted or not be played.
- The DivX VOD code allows you to activate up to 6 devices under one account.

DivX® VOD Deregistration

You should deregister your device with 8 digit DivX deregistration code from your device at www.divx.com/vod. Once the deregistration is executed, you must register your device again to see DivX® VOD contents.

- 1 Press **SETTINGS** to access the main menus.
- 2 Press the Navigation buttons to scroll to **MY MEDIA** and press **OK**.
- 3 Press the **Blue** button.
- 4 Press the Navigation buttons to scroll to **DivX Deregistration** and press **OK**.
- 5 Select **Yes** to confirm.

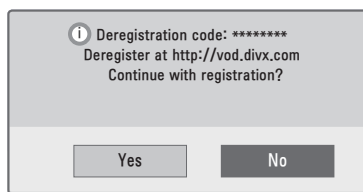

- 6 When you are finished, press **EXIT**. When you return to the previous menu, press **↶ (BACK)**.

Viewing Photos

You can view image files saved on a USB storage device. The displays on the screen may differ based on the model.

- 1 Press **SETTINGS** to access the main menus.
- 2 Press the Navigation buttons to scroll to **MY MEDIA** and press **OK**.
- 3 Press the Navigation buttons to scroll to **Photo List** and press **OK**.
- 4 Select **Drive1** to access the connected USB storage device.
- 5 Press the Navigation buttons to scroll to a folder/file you want and press **OK**.
- 6 View photos by using the following menus/buttons.

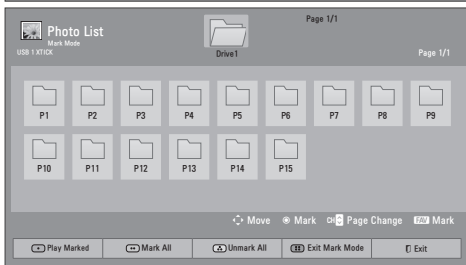
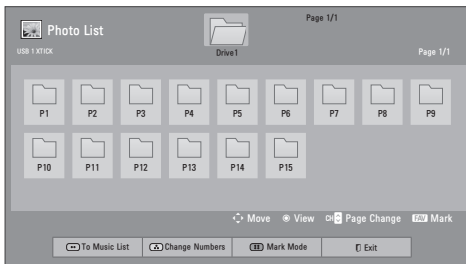

Button	Description
Navigation button	Scrolls the file.
OK	Views the highlighted file or enters the mark mode.
CH (^, v or +, -)	Moves to the previous or next page.
FAV	Enters the mark mode.
Menu	Description
View Marked	Views the selected photo.
Mark All	Selects all files.
Unmark All	Clears all of your selections.
Exit Mark Mode	Exits the Mark Mode.

NOTE

- : Abnormal files are displayed using this graphic.
- : Non-supported files are displayed using this graphic.

- 7 The following options are available while viewing photos.



Option	Description
Slideshow	<ul style="list-style-type: none"> • Starts or stops a slideshow with selected photos. • If there are no selected photos, all photos saved in the current folder display during a slideshow. • To set a slideshow speed, select Option.
BGM (Background Music)	<ul style="list-style-type: none"> • Turns the background music on or off. To set the background music folder, select Option. <div style="border: 1px solid black; padding: 5px; margin-top: 10px;"> <p>NOTE</p> <ul style="list-style-type: none"> • You can't change or set-up the BGM while viewing the *.mpo files (3D camera file). </div>
⌚ (Rotate)	<p>Rotates photos clockwise (90°, 180°, 270°, 360°).</p> <div style="border: 1px solid black; padding: 5px; margin-top: 10px;"> <p>NOTE</p> <ul style="list-style-type: none"> • The supported photo size is limited. You cannot rotate a photo if the resolution of the rotated width is larger than the supported resolution size. </div>
🔍 (Zoom In)	Views the photo by zoom in 2, 4 times by using Blue button.
🔋 (ENERGY SAVING)	Increases or decreases the brightness of your screen.
Option	Shows the Option menu (See p.58).
Hide	Hides the option window. To display the options, press OK .
Exit	Moves to the previous menu screen.

**NOTE**

- Option values changed in Photo List do not affect Movie List and Music List.
- Option values changed in Photo List or Music List are changed likewise in Photo List and Music List, but not Movie List.

Q.MENU options for photo list

- 1 Press **Q. MENU**.
A pop-up window will appear.
- 2 Press the Navigation buttons to scroll to photo list option and press **OK**.
- 3 Press the Navigation buttons to scroll to one of the following options and press **OK**.

Set Photo View.

Option	Description
Slide Speed	Selects a slideshow speed (Fast, Medium, Slow).
BGM	Selects a music folder for the background music. <ul style="list-style-type: none"> • Repeat • Random <div style="border: 1px solid black; padding: 5px; margin-top: 10px;">  NOTE <ul style="list-style-type: none"> • You cannot change the music folder while the background music is playing. </div>

Set Video.

Allows you to change Video presets. (Refer to "PICTURE Settings" on p.62).

Set Audio.

Allows you to change Audio presets. (Refer to "AUDIO Settings" on p.65).



Listening to music

- 1 Press **SETTINGS** to access the main menus.
- 2 Press the Navigation buttons to scroll to **MY MEDIA** and press **OK**.
- 3 Press the Navigation buttons to scroll to **Music List** and press **OK**.
- 4 Select **Drive1** to access the connected USB storage device.
- 5 Press the Navigation buttons to scroll to a folder/file you want and press **OK**.
- 6 Play music by using the following menus/ buttons.









Button	Description
Navigation button	Scrolls through the files.
OK	Plays the highlighted file or enters the mark mode.
CH (▲, ▼ or +, -)	Moves to the previous or next page.
FAV	Enters the mark mode.
Menu	Description
Play Marked	Plays the selected music file.
Mark All	Selects all files.
Unmark All	Clears all of your selections.
Exit Mark Mode	Exit the Mark Mode.

NOTE

-  : Abnormal files are displayed using this graphic.
-  : Non-supported files are displayed using this graphic.

- 7 Control playback by using the following buttons.

Button	Description
	Stops playback.
	Plays a music file.
	Pauses or resumes playback.
	Skips to the previous file.
	Skips to the next file.
Play with Photo	Displays photos during playback.
 (ENERGY SAVING)	Increases or decreases the brightness of your screen.
Option	Shows the Option menu (See p.60).
Hide	Hides the option window. To display the options, press OK .
Exit	Moves to the previous menu screen.

Q.MENU options for music list

- 1 Press **Q. MENU**.
A pop-up window will appear.
- 2 Press the Navigation buttons to scroll to music list option and press **OK**.
- 3 Press the Navigation buttons to scroll to one of the following options and press **OK**.

**NOTE**

- Option values changed in Movie List does not affect the Photo List and Music List.
- Option value changed in Photo List and Music List are changed likewise in Photo List and Music List.

Set Audio Play.

Select Repeat or Random option.

Set Audio.

Allows you to change Audio presets. (Refer to "AUDIO Settings" on p.65).

**NOTE**



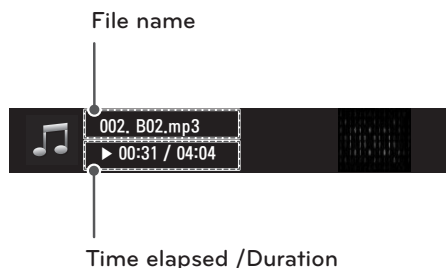





- The TV will not play copy protected files.
 - If the TV is not in use for some time during playback, the information box as a screensaver will appear to prevent image burn.
- To return to the Music list screen, press **OK** or **↶ (BACK)**.



CUSTOMIZING TV SETTINGS

The Main Menu

- 1 Press **SETTINGS** to access the main menus.
- 2 Press the Navigation buttons to scroll to one of the following menus and press **OK**.
- 3 Press the Navigation buttons to scroll to the setting or option you want and press **OK**.
- 4 When you are finished, press **EXIT**.

Menu (Depending on model)		Description
	PICTURE	Adjusts the image size, quality, or effect.
	AUDIO	Adjusts the sound quality, effect, or volume level.
	CHANNEL	Sets up and edit channels.
	TIME	Sets the time, date, or Timer feature.
	LOCK	Locks or unlocks channels and programs.
	OPTION	Customizes the general settings.
	INPUT	Views the input sources with their labels.
	Pentouch	Pentouch allows you to use various functions with touch pen on the TV.
	MY MEDIA	Displays and play movie, photo and music content stored on your USB.

Customizing Settings

PICTURE Settings

- 1 Press **SETTINGS** to access the main menus.
- 2 Press the Navigation buttons to scroll to **PICTURE** and press **OK**.
- 3 Press the Navigation buttons to scroll to the setting or option you want and press **OK**.
 - To return to the previous level, press **↶ (BACK)**.
- 4 When you are finished, press **EXIT**.

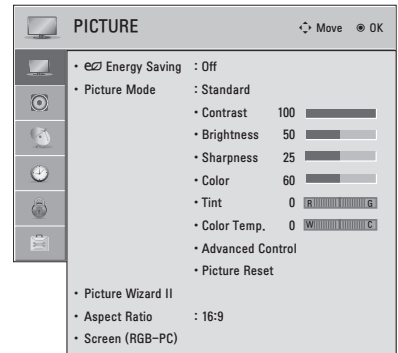

The available picture settings are described in the following.

Setting	Description	
Energy Saving	Reduces the power consumption by adjusting the screen brightness.	
	Option	
	Intelligent sensor	The most suitable picture is automatically adjusted according to the surrounding conditions.
	Off	Select if this feature is not necessary.
	Minimum/ Medium/Maximum	Selects the brightness level.
	Screen off	The screen turns off in 3 seconds. Pressing any button of the remote control will turn on the screen again.
Picture Mode	Selects one of the preset image or customizes options in each mode for the best TV screen performance. You are also able to customize advanced options of each mode. The available preset picture modes vary depending on the TV.	
	Mode	
	Vivid	Adjusts the video image for the retail environment by enhancing the contrast, brightness, color, and sharpness.
	Standard	Adjusts the image for the normal environment.
	 Auto Power Save	Maximizes video image reducing power consumption without hurting picture quality.
	Cinema	Optimizes video image for a cinematic look to enjoy movies as if you are in a movie theater.
	Game	Optimizes the video image for a fast gaming screen such as PCs or games.
Expert 1, 2	Adjusts the detailed video image settings for video experts as well as general viewers.	

Setting	Description	
Picture Wizard II	<p>Adjusts the image quality and calibrates the screen. The customized options will be saved as Expert1 in the Picture Mode.</p> <div style="border: 1px solid black; padding: 5px;"> <p>NOTE</p> <ul style="list-style-type: none"> • If you use Picture Wizard II, the Energy saving feature will turn off automatically. • To reset changes made by Picture Wizard II, operate Picture Reset when Picture Mode is on Expert1. </div>	
Aspect Ratio	Changes the image size to view images at its optimal size (See p.30).	
SCREEN (RGB-PC)	Customizes the PC display options.	
	Option	
	Resolution	Selects a proper resolution when your PC uses 1024 X 768, 1280 X 768, or 1360 X 768 resolution.
	Auto Configure	Sets the TV to optimize the options automatically for the TV display.
	Position	Locates the image at the proper position.
	Size	Adjusts the image size.
	Phase	Eliminates horizontal streaking.
	Reset	Restores the options to the default setting.

Basic Image Options

Setting	Description
Contrast	Increases or decreases the amplitude of the video signal. You may use Contrast when the bright part of the picture is saturated.
Brightness	Adjusts the base level of the signal in the picture.
Sharpness	Adjusts the level of crispness in the edges between the light and dark areas of the picture. The lower the level, the softer the image.
Color	Adjusts intensity of all colors.
Tint	Adjusts the balance between red and green levels.
Color Temp.	Set to warm to enhance hotter colors such as red, or set to cool to enhance cooler colors such as blue.
Advanced Control or Expert Control	Customizes the advanced options.
Picture Reset	Restores the options of each mode to the factory default.

Advanced Image Options

Setting	Description	
Dynamic Contrast	Adjusts the contrast to keep it at the best level according to the brightness of the screen. The picture is improved by making bright parts brighter and dark parts darker.	
Noise Reduction	Reduces screen noise without compromising video quality.	
Gamma	You can adjust brightness of dark areas and middle gray level areas of the picture. <ul style="list-style-type: none"> » Low: Make the dark and middle gray level areas brighter. » Medium: Express the original picture level. » High: Make the dark and middle gray level areas darker. 	
Black Level	Sets black level of the screen to proper level. <ul style="list-style-type: none"> » Low: The reflection of the screen gets darker. » High: The reflection of the screen gets brighter. 	
Film Mode	Makes video clips recorded in film look more natural by eliminating judder effect. DVD and Blu-ray movies are filmed at 24 frames per second (fps).	
Color Gamut	Advanced Control Maximizes the utilization of color to increase color quality. <ul style="list-style-type: none"> » Standard: Displays standard set of colors. » Wide: Increase number of colors used. 	
	Expert Control Displays color domain of the signal. <ul style="list-style-type: none"> » Standard: Displays standard set of colors. » Wide: Increase number of colors used. 	
Edge Enhancer	Shows clearer and distinctive yet natural edges of the video. This function works well over Sharpness UI 60 value.	
xvYCC	This will produce richer colors. This feature represents rich colors as much as a conventional video signal. This function is enabled in "Picture mode - Cinema, Expert" when xvYCC signal is inputted through HDMI.	
Expert Pattern	This is the pattern used for expert adjustment. This function is enabled in "Picture Mode - Cinema, Expert" when you watch DTV.	
Color Filter	This filters specific colors of the video. You can use the RGB filter to set color saturation and hue accurately.	
Color Temperature	Adjusts the overall color of the screen by changing the white baseline.	
	<table border="0"> <tr> <td style="vertical-align: top;"> a. Gamma : Cool, Medium, Warm b. Method : 2 Points <ul style="list-style-type: none"> • Points: Low, High • Pattern: Inner, Outer • Red/Green/Blue: The adjustment range is -50 - +50 </td> <td style="vertical-align: top;"> c. Method : 20 Point IRE <ul style="list-style-type: none"> • Pattern : Inner, Outer • IRE (Institute of Radio Engineers) is the unit to display the size of the video signal and can be set among 0, 5, 10, 15 - 100 Plasma TV. You can adjust Red, Green or Blue according to each setting. • Red/Green/Blue: The adjustment range is -50 - +50. d. Apply to all inputs </td> </tr> </table>	a. Gamma : Cool, Medium, Warm b. Method : 2 Points <ul style="list-style-type: none"> • Points: Low, High • Pattern: Inner, Outer • Red/Green/Blue: The adjustment range is -50 - +50
a. Gamma : Cool, Medium, Warm b. Method : 2 Points <ul style="list-style-type: none"> • Points: Low, High • Pattern: Inner, Outer • Red/Green/Blue: The adjustment range is -50 - +50 	c. Method : 20 Point IRE <ul style="list-style-type: none"> • Pattern : Inner, Outer • IRE (Institute of Radio Engineers) is the unit to display the size of the video signal and can be set among 0, 5, 10, 15 - 100 Plasma TV. You can adjust Red, Green or Blue according to each setting. • Red/Green/Blue: The adjustment range is -50 - +50. d. Apply to all inputs	
Color Management System	As the tool used by the experts to make adjustments by using test patterns, this does not affect other colors but can be used to selectively adjust the 6 color areas (Red/Green/Blue/Cyan/Magenta/Yellow). Color difference may not be distinctive even when you make the adjustments for general video. Adjusts Cyan/Magent. Red/Green/Blue/Yellow/Cyan/Magenta Color: The adjustment range is -30 - +30. Red/Green/Blue/Yellow/Cyan/Magenta Tint: The adjustment range is -30 - +30. Red/Green/Blue/Yellow/Cyan/Magenta Luminance: The adjustment range is -30 - +30. This feature is disabled in RGB-PC and HDMI-PC mode.	

AUDIO Settings

- 1 Press **SETTINGS** to access the main menus.
- 2 Press the Navigation buttons to scroll to **AUDIO** and press **OK**.
- 3 Press the Navigation buttons to scroll to the setting or option you want and press **OK**.
- To return to the previous level, press **↶ (BACK)**.
- 4 When you are finished, press **EXIT**.



The available audio settings are described in the following.

Setting	Description
Auto Volume	Activates the Auto Volume feature to keep the volume level consistent whenever you change channels. The volume level may not be consistent due to different signal conditions of broadcasting stations.
Clear Voice II	Enhances human voice clarity. You can adjust the level of clarity after you turn this feature on.
Balance	Adjust balance between the left and right speakers according to your room environment.
Sound Mode	Selects one of the preset sound modes or allows you to customize options in each mode.
Mode	
Standard	Select when you want standard-quality sound.
Music	Select when you listen to music.
Cinema	Select when you watch movies.
Sport	Select when you watch sports events.
Game	Select when you play games.
<div style="border: 1px solid black; padding: 5px;"> <p>NOTE</p> <ul style="list-style-type: none"> If sound quality or volume is not at the level you want, it is recommended to use a separate home theater system or amplifier to cope with different user environments. If the Clear Voice II feature is on, Virtual Surround will not be activated. </div>	
Option	
Virtual Surround	Virtual Surround is a patented LG proprietary sound processing technology that strives immersive 5.1 surround sound with just two front speakers.
Treble	Controls the dominant sounds in the output. When you turn up the treble, it will increase the output to the higher frequency range.
Bass	Controls the softer sounds in the output. When you turn up the bass, it will increase the output to the lower frequency range.
Reset	Resets the sound mode to the default setting.

Digital Audio Out	Allows you to change the type of audio output from the TV. If you select "Digital Audio Out - Auto" when Dolby digital is available, SPDIF (Sony Philips Digital InterFace) output will be Dolby Digital. If you select "Digital Audio Out - PCM" when Dolby digital is not available, SPDIF output will be PCM (Pulsecode modulation).		
	Item	Audio Input	Digital Audio output
	Auto	MPEG DD HE-AAC	PCM DD DD
	PCM	All	PCM
TV Speaker	Turns on the internal speaker of the TV when using an external Hi-Fi system. You can use the TV speaker as an audio output device even if there is no video input.		

CHANNEL Settings

- 1 Press **SETTINGS** to access the main menus.
- 2 Press the Navigation buttons to scroll to **CHANNEL** and press **OK**.
- 3 Press the Navigation buttons to scroll to the setting or option you want and press **OK**.
 - To return to the previous level, press **↶ (BACK)**.
- 4 When you are finished, press **EXIT**.

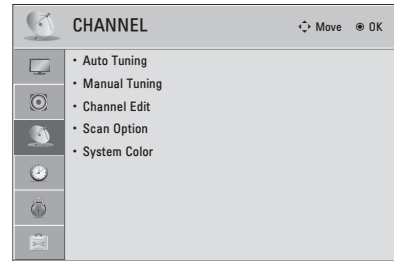

The available channel settings are described in the following.

Setting	Description
Auto Tuning	Tunes and stores all available channels through antennas or cable inputs (See p.24).
Manual Tuning	Tunes and stores the channels you want manually (See p.24).
Channel Edit	Adds or deletes channels on the channel (See p.25).
Scan Option	*This feature is not available for all models. Whether to search all channels or the first channel of virtual channels is switched with CH button when one or more virtual channels exist at one physical channel.
	Option
	Primary Channel Only scan the first channel of virtual channels.
	All Channels Scan full channel.
System Color	Sets color suited the each signal. This feature is disable in digital channel.

TIME Settings

- 1 Press **SETTINGS** to access the main menus.
- 2 Press the Navigation buttons to scroll to **TIME** and press **OK**.
- 3 Press the Navigation buttons to scroll to the setting or option you want and press **OK**.
 - To return to the previous level, press **↶ (BACK)**.
- 4 When you are finished, press **EXIT**.

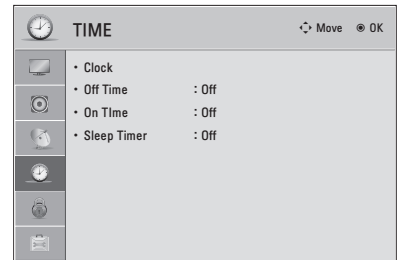

The available time settings are described in the following.

Setting	Description
Clock	Sets the time, date, time zone, and daylight-saving time feature. The time will be set automatically according to a digital channel signal which includes time information provided by the broadcasting station. If not, set the time and date manually.
Off Time/On Time	<p>Sets the time to turn on or off the TV automatically. To use this function, you should set the current time and date in advance.</p> <div style="border: 1px solid black; padding: 5px;"> <p>NOTE</p> <ul style="list-style-type: none"> • If you do not press any button within 2 hours after the TV turns on by the On Time feature, the TV will enter Standby mode automatically. • If you set both Off time and On time features to the same time, the Off time feature overrides the On time feature. </div>
Sleep Timer	Sets the length of time until the TV to turns off. When you turn the TV off and turn it on again, the Sleep timer feature will be set to off.

LOCK Settings

- 1 Press **SETTINGS** to access the main menus.
- 2 Press the Navigation buttons to scroll to **LOCK** and press **OK**.
- 3 Press the Navigation buttons to scroll to the setting or option you want and press **OK**.
 - To return to the previous level, press **↶ (BACK)**.
- 4 When you are finished, press **EXIT**.

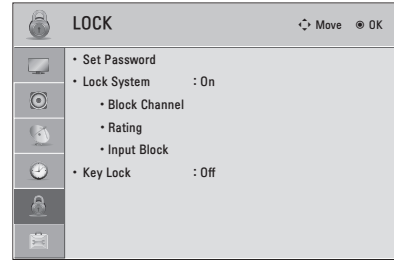

The available time settings are described as follows.

Setting	Description	
Set Password	Changes the 4-digit password. The default PIN is "0 0 0 0". If you forget your password, press "0-3-2-5" on the remote control.	
Lock System	Activates or deactivates the lock system.	
Block Channel	Blocks the channels that contain inappropriate contents for children by pressing the Yellow button. The Lock icon appears in front of the blocked channels. The channels can be selected but the screen blank and the audio is muted. To watch a locked channel, enter the password.	
Rating	Blocks the movies that are only broadcasted on the TV and contain inappropriate contents.	
	Rating	
	Blocking Off	General audiences – All ages admitted
	10 and above	Parental guidance suggested – Some material may not be suitable for children
	12 and above	Parents strongly cautioned – Some material may be inappropriate for children under 12
	14 and above	Restricted – Under 14 requires accompanying parent or adult guardian
	16 and above	No one 16 and under admitted.
18 and above	Adults only	
Input Block	Block the input sources.	
Key Lock	Locks or unlocks the buttons on the TV.	

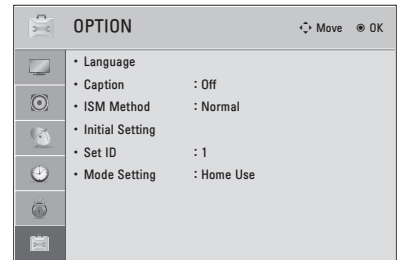

OPTION Settings

- 1 Press **SETTINGS** to access the main menus.
- 2 Press the Navigation buttons to scroll to **OPTION** and press **OK**.
- 3 Press the Navigation buttons to scroll to the setting or option you want and press **OK**.
 - To return to the previous level, press **↶ (BACK)**.
- 4 When you are finished, press **EXIT**.



The available general settings are described in the following.

Setting	Description				
Language	Selects a desired language.				
	Option				
	Menu Language	Selects a language for the display text.			
	Audio Language	Selects an audio language for your program. This feature operates only in the DTV mode.			
Caption	Sets whether to display captions and customize your option in each mode.				
	Mode				
	Analog	<table border="1"> <tr> <td>CC 1-2 (Closed Captioning)</td> <td rowspan="2">Displays the audio portion of a TV program as text on the TV screen. CC1 is the most common mode in use.</td> </tr> <tr> <td>Text 1-2</td> </tr> </table>	CC 1-2 (Closed Captioning)	Displays the audio portion of a TV program as text on the TV screen. CC1 is the most common mode in use.	Text 1-2
	CC 1-2 (Closed Captioning)	Displays the audio portion of a TV program as text on the TV screen. CC1 is the most common mode in use.			
Text 1-2					
Digital	This is only available for the digital broadcasting system.				
ISM Method	Prevents image sticking or removes a ghost image. A frozen still picture displayed on the screen for prolonged periods can result in a ghost image.				
	Mode				
	Normal	Use this setting if you are careful not to leave a stationary image on the screen for long periods of time.			
	Orbiter	Avoids a ghost image on the screen. The image will move every 2 minutes to help prevent ghost images. However, it is best not to allow any fixed image to remain on the screen.			
	Color Wash	Removes a ghost image on the screen. The color block with the screen moved a little and the white pattern are alternately displayed. It is difficult to see the after image on all colors. Once it has been corrected it will not be visible in any color.			

Setting	Description	
Initial Setting	<p>Resets the TV to factory default and erases all stored channels. Customizes the TV settings to suit your preference. The initial setup screen will appear when you turn on the TV for the first time.</p> <div style="border: 1px solid black; padding: 5px; margin-top: 10px;"> <p> NOTE</p> <ul style="list-style-type: none"> • When selecting "Lock System - On" in the LOCK menu, the message to enter the password appears. • If you forget your password, press "0-3-2-5" on the remote control. </div>	
	<p>Setting</p>	
	<p>Language</p>	<p>Selects a desired language.</p>
	<p>Mode Setting</p>	<p>Selects Home Use for the home environment. Selects Store Demo for the retail environment. Selects Demo Mode to set to show special features of the TV. You can cancel the demo mode by pressing any buttons except the Volume and Mute buttons.</p> <div style="border: 1px solid black; padding: 5px; margin-top: 10px;"> <p> NOTE</p> <ul style="list-style-type: none"> • When selecting Store Demo, Demo Mode will be activated. </div>
	<p>Time Zone</p>	<p>Sets the time zone and daylight savings.</p>
	<p>Auto Tuning</p>	<p>Scans and saves available channels automatically.</p>
<p>Set ID</p>	<p>Adds an ID to the connected devices.</p>	
Mode Setting	<p>Default selection is "Home Use". We recommend setting the TV to "Home Use" mode for the best picture in your home environment.</p>	
	<p>Option</p>	
	<p>Home Use</p>	<p>Selects it for the home environment.</p>
	<p>Store Demo</p>	<p>Selects it for the retail environment.</p>
	<p>Demo Mode</p>	<p>Sets to show special features of the TV. You can cancel the demo mode by pressing any buttons except the Volume and Mute buttons.</p>

MAKING CONNECTIONS

Connect various external devices to the TV and switch input modes to select an external device. For more information on an external device's connection, refer to the manual provided with each device.

Available external devices are: HD receivers, DVD players, VCRs, audio systems, USB storage devices, PC, gaming devices, and other external devices.

NOTE

- If you record a TV program on a DVD recorder or VCR, make sure to connect the TV signal input cable to the TV through a DVD recorder or VCR. For more information on recording, refer to the manual provided with the connected device.
- The external device connection may differ from the model.
- Connect external devices to the TV regardless of the order of the TV port.
- If you connect a gaming device to the TV, use the cable supplied with the gaming device.
- Refer to the external equipment's manual for operating instructions.

Connecting to an antenna or cable

Connect an antenna, cable, or cable box to watch TV while referring to the following. The illustrations may differ from the actual items and a RF cable is optional.

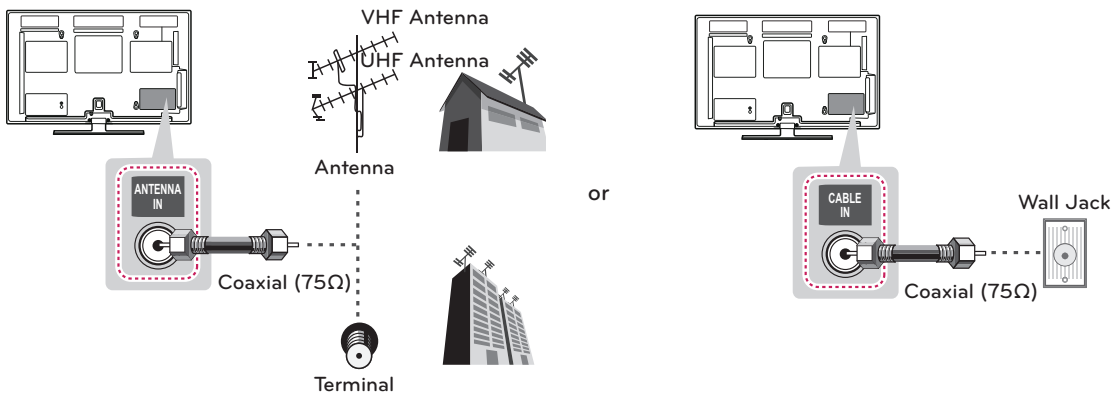

CAUTION

- Make sure not to bend the copper wire of the RF cable.

Copper wire

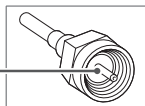

- Complete all connections between devices, and then connect the power cord to the power outlet to prevent damage to your TV.

NOTE

- To improve the picture quality in a poor signal area, please purchase a signal amplifier and install properly.
- Use a signal splitter to use more than 2 TVs.
- If the antenna is not installed properly, contact your dealer for assistance.

Connection Overview

Connect various external devices to the ports on the TV back panel.

- 1 Find an external device you want to connect to your TV as shown on the following illustration.
- 2 Check the connection type of the external device.
- 3 Go to the appropriate illustration and check the connection details.

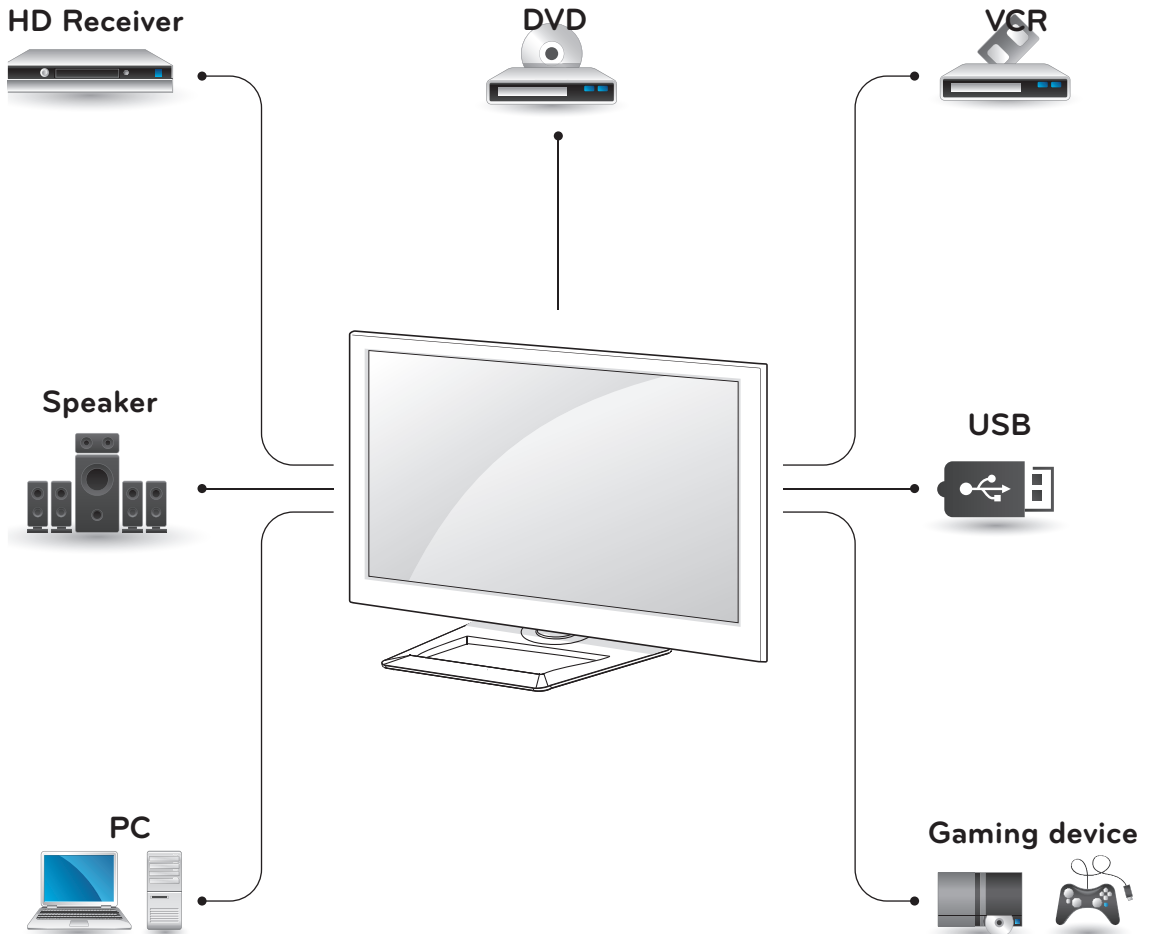

- This part of MAKING CONNECTIONS mainly uses picture for PA6500 series.

Connecting to a HD receiver, DVD, or VCR player

Connect a HD receiver, DVD, or VCR player to the TV and select an appropriate input mode.

HDMI Connection

HDMI is the best way to connect a device.

Transmits the digital video and audio signals from an external device to the TV. Connect the external device and the TV with the HDMI cable as shown in the following illustration.

! NOTE

- Use the latest High Speed HDMI™ Cable with CEC (Customer Electronics Control) function.
- High Speed HDMI™ Cables are tested to carry an HD signal up to 1080p and higher.

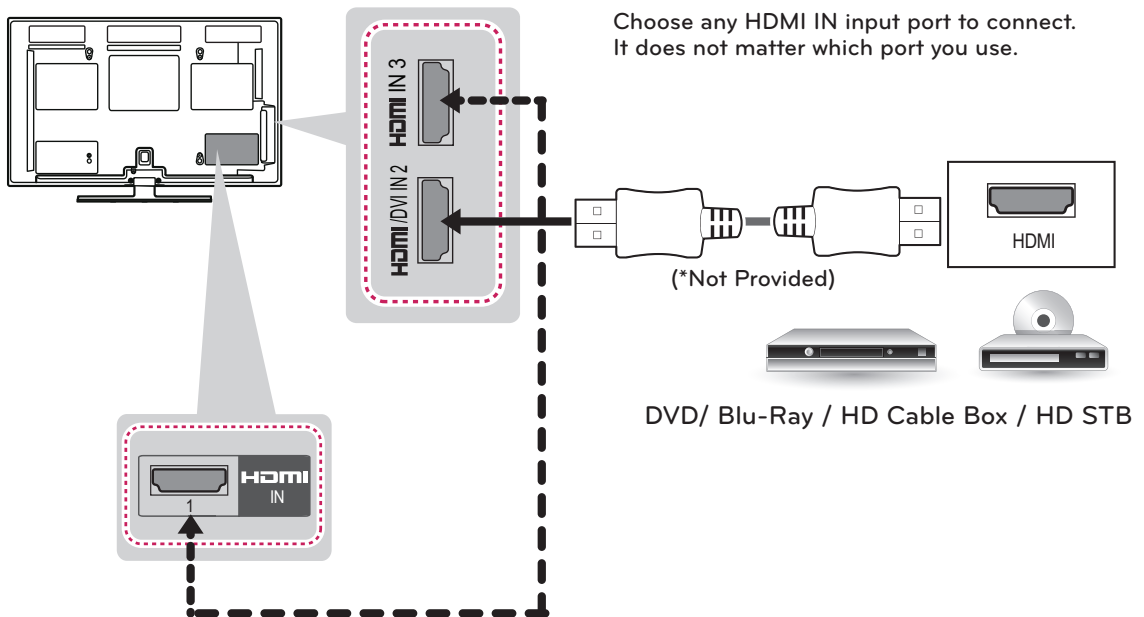

DVI to HDMI Connection

Transmits the digital video signal from an external device to the TV. Connect the external device and the TV with the DVI-HDMI cable as shown in the following illustration. To transmit an audio signal, connect an audio cable.

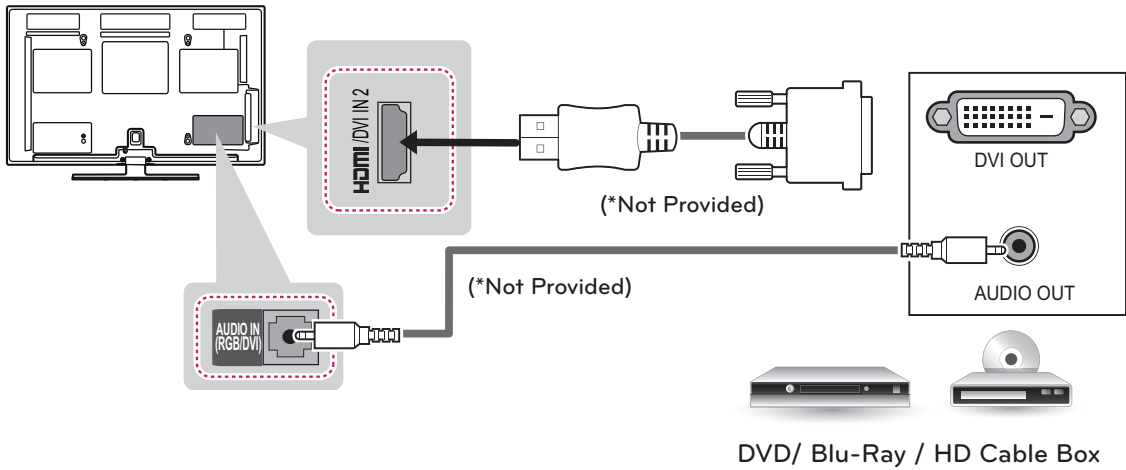

Component Connection

Transmits analog video and audio signals from an external device to the TV. Connect the external device and the TV with a component cable as shown in the following illustration.



NOTE

- If cables are installed incorrectly, it could cause the image to display in black and white or with distorted color.
- Check to ensure each cable is matched with the corresponding color connection.

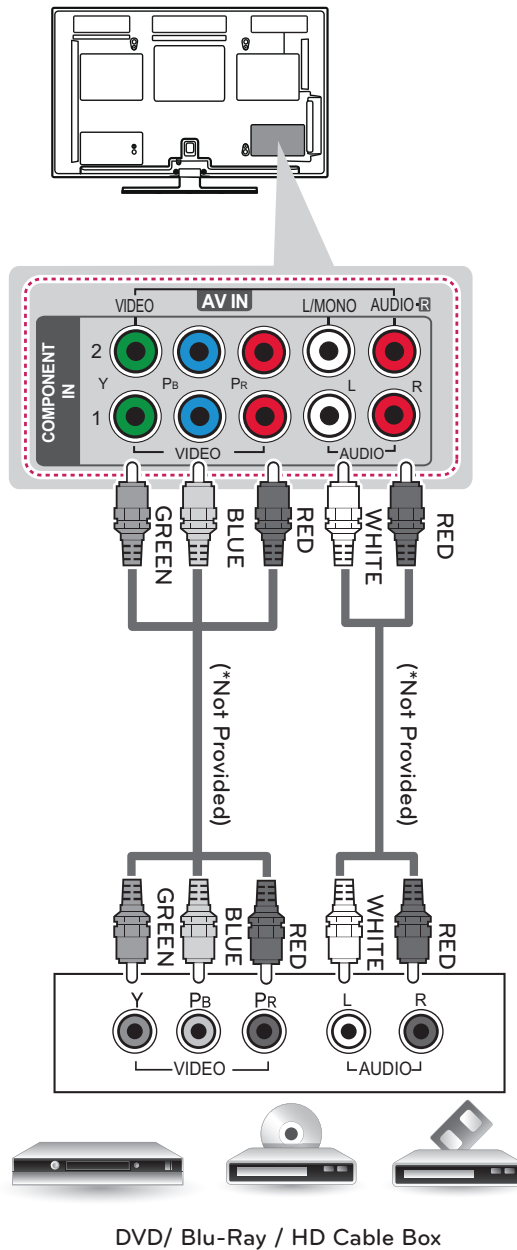

Composite Connection

Transmits analog video and audio signals from an external device to the TV. Connect the external device and the TV with a composite cable as shown in the following illustration.

NOTE

- If you have a mono VCR, connect the audio cable from the VCR to the AUDIO L/MONO jack of the TV.

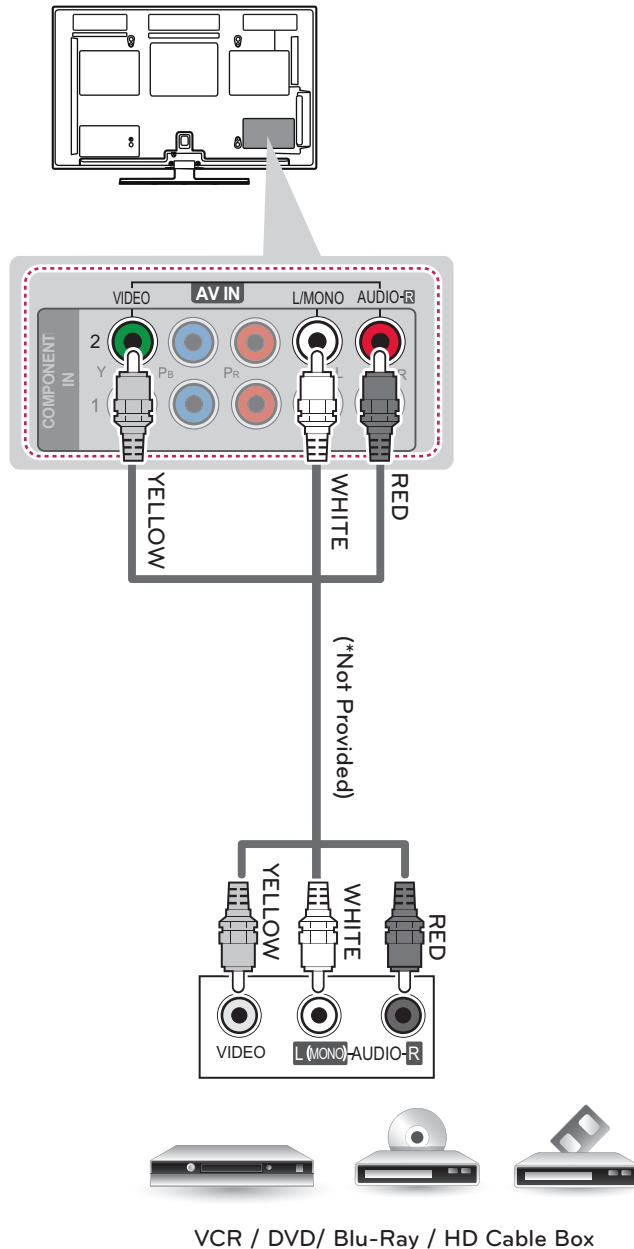

VCR / DVD / Blu-Ray / HD Cable Box

Connecting to a PC

! NOTE

- It is recommended to use the HDMI connection for the best image quality.
- Depending on the graphics card, DOS mode may video not work if a HDMI to DVI Cable is in use.
- In PC mode, there may be noise associated with the resolution, vertical pattern, contrast or brightness. If noise is present, change the PC output to another resolution, change the refresh rate to another rate or adjust the brightness and contrast on the PICTURE menu until the picture is clear.
- The synchronization input form for Horizontal and Vertical frequencies is separate.
- Depending on the graphics card, some resolution settings may not allow the image to be positioned on the screen properly.

HDMI Connection, DVI to HDMI Connection or RGB Connection

Choose method A, B, or C to make connection.

Method A: HDMI Connection

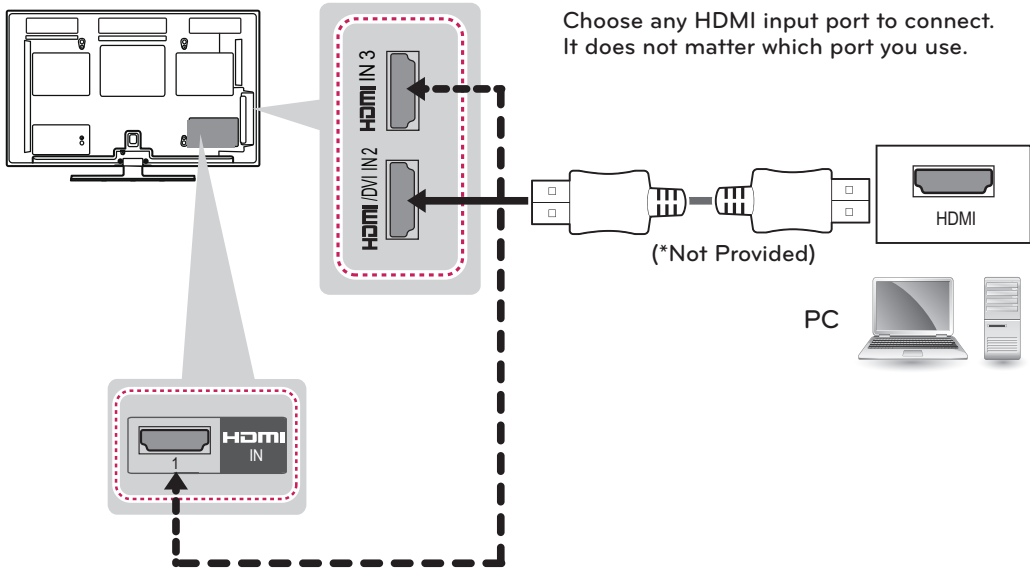

Method B: DVI to HDMI Connection

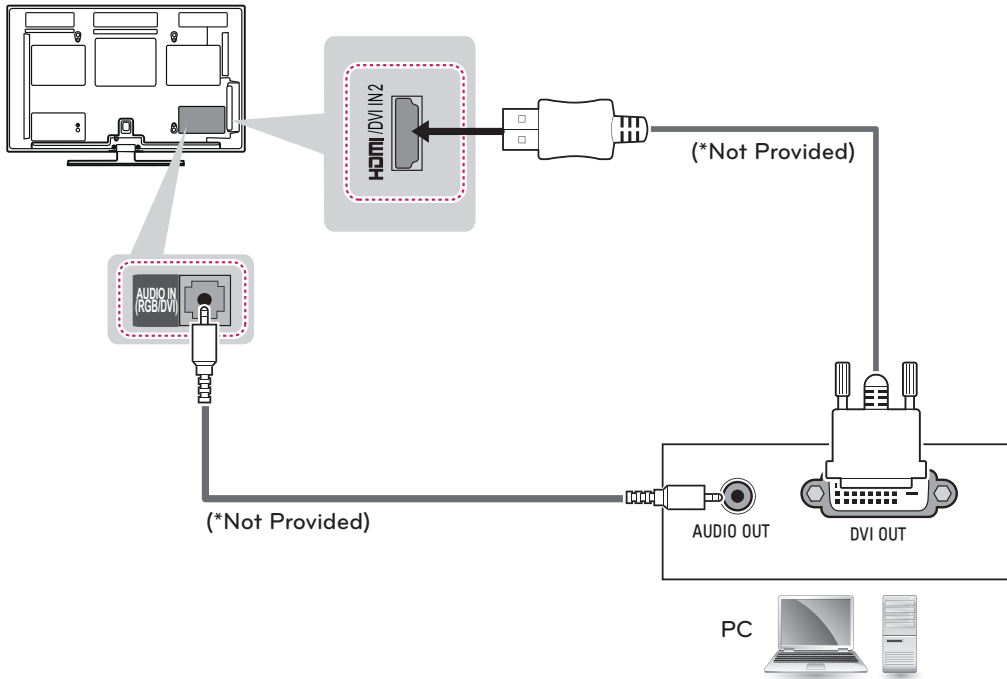

Method C: RGB Connection

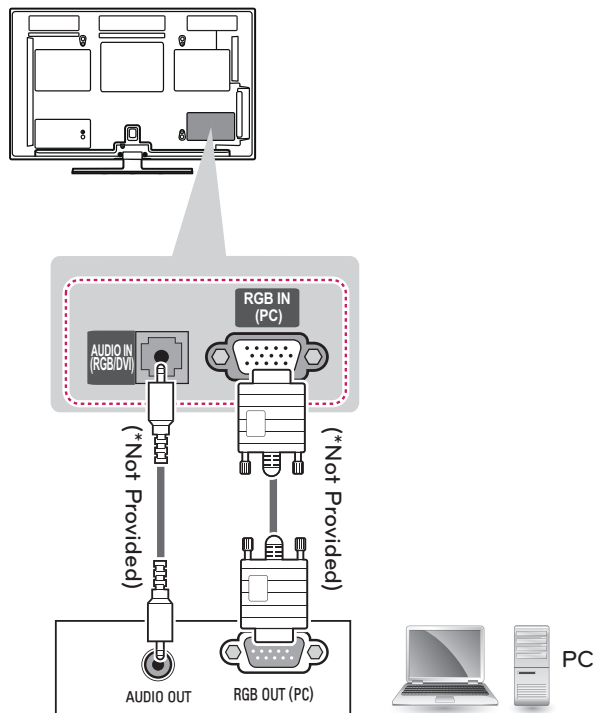

Connecting to an Audio System

You may use an optional external audio system instead of the built-in speaker.



NOTE

- If you use an optional external audio device instead of the built-in speaker, set the TV speaker feature to off.

Digital Optical Audio Connection

Transmits a digital audio signal from the TV to an external device. Connect the external device and the TV with the optical audio cable as shown in the following illustration.

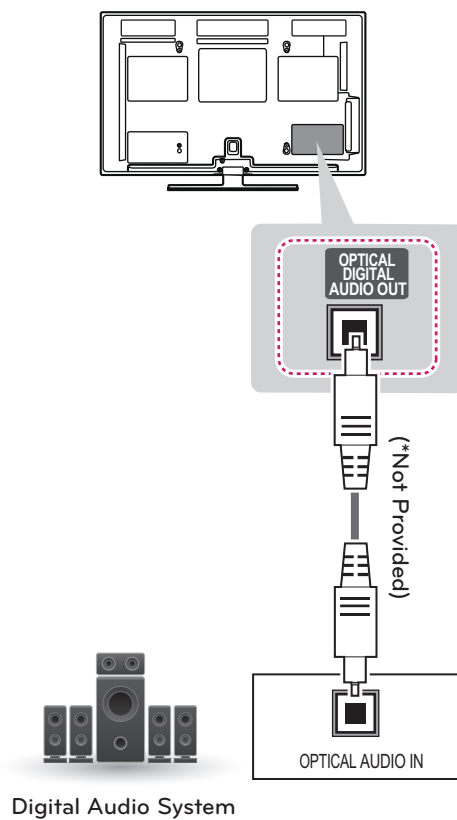

Connecting to a USB

Connect a USB storage device such as a USB flash memory, external hard drive or a USB memory card reader to the TV and access the My media menu to use various multimedia files.

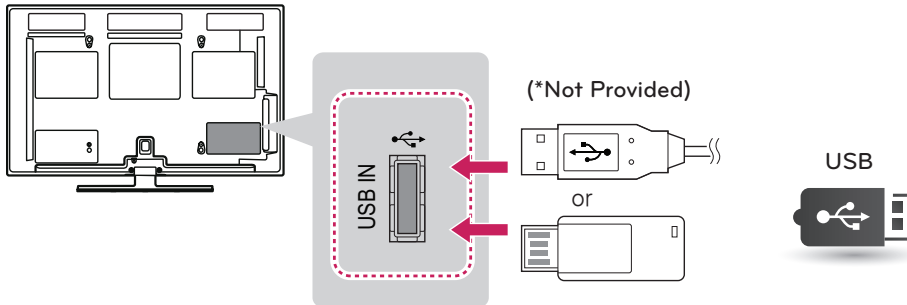

SIMPLINK Connection

Use the TV remote control to play and control the AV device connected with the HDMI cable through HDMI-CEC. Your TV only works with devices that support HDMI-CEC. But only devices with the **SIMPLINK** logo are fully supported.

Connect one end of the HDMI cable to the HDMI/DVI IN or HDMI IN terminal on the rear of the TV and the other end to the SIMPLINK device.

! NOTE

- If the connected device does not support HDMI-CEC, the SIMPLINK feature is unavailable.
- To operate SIMPLINK, you should use an High Speed HDMI cable with the CEC (Consumer Electronics Control) function.
- SIMPLINK may not work properly with third-party devices.

Activating and Using the SIMPLINK menus

- 1 Press **SIMPLINK** to access the SIMPLINK menus.
- 2 Press the Navigation buttons to select to **On**.
- 3 Press the Navigation buttons to scroll to one of the devices and press **OK**.

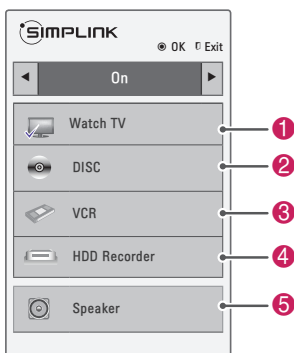

No.	Description
1	Displays the previously viewed TV channel.
2	Plays discs. When multiple discs are available, the title of the disc appears at the bottom of the screen.
3	Controls the connected VCR.
4	HDD recordings playback: Controls the recording stored in HDD.
5	Audio out to home theater speaker or Audio out to TV: Changes the audio output between Home theater speaker and TV speaker.

- A check mark appears in front of the selected device.
- Available devices display in a bright color.
- Unavailable devices display in grey.

- 4 Control the selected AV device.
 - Direct Play: After connecting AV devices to the TV, you can directly control the devices and play media without additional settings.
 - Select AV device: Enables you to select one of the AV devices connected to the TV.
 - Disc playback: Control connected AV devices by pressing the Navigation buttons, **OK**, **▶**, **■**, **⏸**, **◀** and **▶▶**.
 - Power off all devices: When you power off the TV, all connected devices are turned off.
 - Switch audio-out: Offers an easy way to switch audio-out.
 - Sync Power on: When the equipment with SIMPLINK function connected HDMI terminal starts to play, The TV will automatically turn on.

! NOTE

- If you change the input source by pressing **INPUT**, the progressing function of the SIMPLINK device will stop.
- If you select a device that has the home theater feature, the sound output automatically switches to the home theater speaker and the TV speaker turns off.
- If a connected SIMPLINK home theater system does not play the audio from the TV, connect the DIGITAL AUDIO OUT terminal on the rear of the TV to the DIGITAL AUDIO IN terminal on the back of the SIMPLINK device with an optical cable.

MAINTENANCE

Update and clean your TV regularly to keep the best performance and to extend the product lifespan.

Updating the TV Firmware

Download and install the latest firmware through DTV signal to enhance or change the product function, or add new features.

To check the current firmware version or update the firmware,

- 1 Press **SETTINGS** to access the main menu.
- 2 Press the **Red** button to scroll **Customer Support**.
- 3 Press the Navigation buttons to scroll to **Software Update** and press **OK**.
The current firmware version displays.

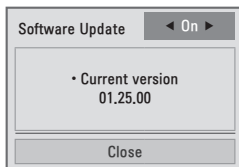

OTA (Over-The-Air): When software update is on, the TV will automatically check for software updates. A pop-up window will appear on the screen when an update is available.

! NOTE

- If you change the channel during the firmware update through OTA, the update is stopped.
- The process resumes when you go back to the original channel. The update continues even when the power is switched off using the remote control. The system operates normally once the update is complete.
- You can check the software update status in the Software Update menu or from the update information displayed under the channel banner.

- 4 When the update is complete, the TV will automatically restart in 5 seconds.
You may need to reset some **CHANNEL**, **PICTURE**, or **AUDIO** menus.

! NOTE

- You cannot downgrade back to an older firmware version.
- The period of time for the firmware update may be different depending on the firmware size and DTV signal strength.

Cleaning Your TV



CAUTION

- Make sure to turn the power off and disconnect the power cord and all other cables first.
- When the TV is left unattended and unused for a long time, disconnect the power cord from the wall outlet to prevent possible damage from lightning or power surges.

Screen, frame, cabinet and stand

To remove dust or light dirt, wipe the surface with a dry, clean, and soft cloth.

To remove major dirt, wipe the surface with a soft cloth dampened in clean water or a diluted mild detergent. Then wipe immediately with a dry cloth.



CAUTION

- Do not push, rub, or hit the surface with your fingernail or a sharp object, as this may result in scratches on the screen and image distortions.
- Do not use any chemicals, such as waxes, benzene, alcohol, thinners, insecticides, air fresheners, lubricants, as these may damage the screen's finish and cause discoloration.
- Do not spray liquid onto the surface. If water enters the TV, it may result in fire, electric shock, or malfunction.

Power cord

Remove the accumulated dust or dirt on the power cord regularly.

Preventing "Image burn" or "Burn-in" on your TV screen

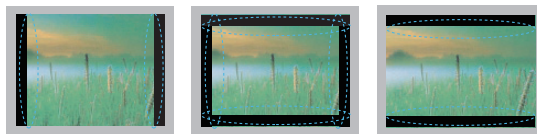

- If a fixed image displays on the TV screen for a long period of time, it will be imprinted and become a permanent disfigurement on the screen. This is "image burn" or "burn-in" and not covered by the warranty.
- If the aspect ratio of the TV is set to 4:3 for a long period of time, image burn may occur on the letterboxed area of the screen.
- Avoid displaying a fixed image on the TV screen for a long period of time (1 or more hours for the Plasma TV) to prevent image burn.

TROUBLESHOOTING

General

Problem	Resolution
Cannot control the TV with the remote control.	<ul style="list-style-type: none"> • Check the remote control sensor on the product and try again. • Check if there is any obstacle between the product and the remote control. • Check if the batteries are still working and properly installed (⊕ to ⊕, ⊖ to ⊖).
No image display and no sound is produced.	<ul style="list-style-type: none"> • Check if the product is turned on. • Check if the power cord is connected to a wall outlet. • Check if there is a problem in the wall outlet by connecting other products.
Image appears slowly when the TV turns on.	<ul style="list-style-type: none"> • The image is muted during the product startup process. This is normal. If the image does not appear in a few minutes, unplug the TV for 30 seconds and try again. If the image still does not appear, contact the authorized service center in your local area.
Cannot connect external devices.	<ul style="list-style-type: none"> • Refer to the "Connection Overview" and connect an external device.
The TV turns off suddenly.	<ul style="list-style-type: none"> • Check the power control settings. The power supply may be interrupted. • Check if the Auto sleep feature is activated in the Time settings. Refer to the "Sleep Timer". • If there is no signal while the TV is on, the TV will turn off automatically after 15 minutes of inactivity.

Audio

Problem	Resolution
No sound is produced while images are displaying.	<ul style="list-style-type: none"> • Press VOL + or - button. • Check if the sound is muted by pressing MUTE. • Scroll to other channels. There may a problem with the broadcast. • Check if the TV Speaker feature is activated in the menu option.
No output from one of the speakers	<ul style="list-style-type: none"> • Adjust Balance in the menu option.
Unusual sound from inside the TV is produced.	<ul style="list-style-type: none"> • A change in ambient humidity or temperature may result in an unusual noise when the product turns on or off. There is no problem with your product.

Video

Problem	Resolution
An image displays in black and white or the color quality is poor.	<ul style="list-style-type: none"> Adjust the color setting in the menu option. Keep a sufficient distance between this product and other electronic products. Scroll to other channels. There may a problem with the broadcast.
Horizontal or vertical bars appears or images blur	<ul style="list-style-type: none"> Check if there are local interferences such as an electrical appliance or power tool.
Lines or streaks appear on images	<ul style="list-style-type: none"> Check the antenna or aim the antenna to the proper direction.
Afterimages (ghosts) appear when the product turns off	<ul style="list-style-type: none"> Pixels may have been damaged from a fixed image displayed for a long time (image burn). Use a screen saver to prevent the pixel damage on the screen.
The power is on but the screen appears extremely dark.	<ul style="list-style-type: none"> Adjust the brightness and contrast in the menu option.
"No Signal" appears on the screen.	<ul style="list-style-type: none"> Check if the signal cable is connected between the TV and products properly. Check the selected input source by pressing INPUT.
Black spots appear on the screen.	<ul style="list-style-type: none"> Several pixels in red, green, white, or black may appear on the screen that can attribute to the characteristics of the panel. This is normal.
The display offset is wrong.	<ul style="list-style-type: none"> Adjust the position setting in the Picture menu. Check if the video card resolution and frequency are supported by the product. If the frequency is out of range, set to the recommended resolution using the display settings on the external device.
Thin lines appear in the background of the screen.	<ul style="list-style-type: none"> Check the video cable connections.
Horizontal noises appear or characters blur.	<ul style="list-style-type: none"> Adjust the Phase setting in the menu option. Refer to the "SCREEN (RGB-PC)".
The reception on some channels is poor	<ul style="list-style-type: none"> Scroll to other channels. There may a problem with the broadcast. The station signal may be weak. Aim the antenna to the proper direction. Check if there is local interferences such as an electrical appliance or power tool.

Movie

Problem	Resolution
The file does not appear on the Movie List.	<ul style="list-style-type: none"> Check whether the extension is supported.
Message is displayed saying "This file is invalid" or the audio is working normally but the video is not working normally.	<ul style="list-style-type: none"> Check whether the file is playing normally on a PC. (Check whether the file is damaged.) Check whether the resolution is supported. Check whether the video/audio codec is supported. Check whether the frame rate is supported.
Message is displayed saying "Unsupported Audio" or the video is working normally but the audio is not working normally.	<ul style="list-style-type: none"> Check whether the file is playing normally on a PC. (Check whether the file is damaged.) Check whether the audio codec is supported. Check whether the bit rate is supported. Check whether the sample rate is supported.
Subtitle is not working.	<ul style="list-style-type: none"> Check whether the file is playing normally on a PC. (Check whether the file is damaged.) Check whether the video file and subtitle file name are the same. Check whether the video file and subtitle file are located in the same folder. Check whether the subtitle file is supported. Check whether the language is supported. (When you open the subtitle file in Memo Pad, you can check the language of the subtitle file.)

Pentouch

Problem	Resolution
The touch pen does not work.	<ul style="list-style-type: none"> • Check that you used the remote control to enter Pentouch mode. • Check that the Pentouch dongle is connected to the computer and the red LED is on. • Press the  (POWER) button on the touch pen to check that it is powered on. • Check that the touch pen is paired for use. (The touch pen is correctly paired if the red LED is on once when you press the Touch Home button on the touch pen.) • Set the computer screen to display only on the TV.
The TV screen doesn't look normal when using Pentouch.	<ul style="list-style-type: none"> • Check that the computer is correctly connected to the TV. • Check that you are using the optimal resolution. • Set the aspect ratio on the TV to Just Scan.
The touch pen is touched on wrong positions.	<ul style="list-style-type: none"> • Set the computer screen to display only on the TV. • If the point you touch on the TV screen using the touch pen and the point indicated as touched on the computer screen do not match when the computer and the TV are connected by a PC signal (RGB) cable, use the TV remote control to select [SETTINGS] → [Picture] → [Screen] (RGB-PC), then select [Auto Config.] to adjust the screen.
The touch pen movement is not smooth.	<ul style="list-style-type: none"> • Check whether the computer and the TV are too far from each other. Check whether there are too many obstructions between the computer and the TV. • Check whether many other applications are running on the computer. (Please avoid running other applications while using the Pentouch program.)

SPECIFICATIONS

Product specifications may be changed without prior notice due to upgrade of product functions.

Power requirement		AC100 - 240 V ~ 50/60 Hz
Television System		NTSC, PAL-M/N, SBTVD
Program Coverage		VHF 2-13, UHF 14-69, CATV 1-135
External Antenna Impedance		75 Ω
Environment condition	Operating Temperature	0 - 40 °C
	Operating Humidity	Less than 80 %
	Storage Temperature	-20 - 60 °C
	Storage Humidity	Less than 85 %

MODELS		42PA4500 (42PA4500-SF)	50PA4500 (50PA4500-SF)
Dimensions (Width x Height x Depth)	With stand	983.6 mm x 655.0 mm x 246.7 mm	1168.0 mm x 758.0 mm x 297.0 mm
	Without stand	983.6 mm x 601.3 mm x 58.0 mm	1168.0 mm x 704.0 mm x 53.0 mm
Weight	With stand	20.6 kg	28.2 kg
	Without stand	19.0 kg	25.8 kg
Current Value / Power consumption		2.1 A / 210 W	2.8 A / 280 W

MODELS		42PA4900 (42PA4900-SD)	50PA4900 (50PA4900-SD)
Dimensions (Width x Height x Depth)	With stand	983.6 mm x 655.0 mm x 246.7 mm	1168.0 mm x 758.0 mm x 297.0 mm
	Without stand	983.6 mm x 601.3 mm x 58.0 mm	1168.0 mm x 704.0 mm x 53.0 mm
Weight	With stand	20.6 kg	28.2 kg
	Without stand	19.0 kg	25.8 kg
Current Value / Power consumption		2.1 A / 210 W	2.8 A / 280 W

MODELS		50PA6500 (50PA6500-SA)	60PA6500 (60PA6500-SA)
Dimensions (Width x Height x Depth)	With stand	1168.0 mm x 758.0 mm x 297.0 mm	1386.8 mm x 883.2 mm x 354.7 mm
	Without stand	1168.0 mm x 704.0 mm x 53.0 mm	1386.8 mm x 818.2 mm x 53.0 mm
Weight	With stand	28.8 kg	40.6 kg
	Without stand	26.4 kg	36.4 kg
Current Value / Power consumption		2.9 A / 290 W	4.3 A / 430 W

RGB (PC), HDMI (PC) supported mode

Resolution	Horizontal Frequency (KHz)	Vertical Frequency (Hz)
640x350	31.468	70.09
640x480	31.469	59.94
720x400	31.468	70.08
800x600	37.879	60.31
1024x768	48.363	60.00
1280x1024 HDMI-PC	63.981	60.02
1360x768	47.72	59.80
1920x1080	67.5	60.00

For 50/60PA6500

HDMI (DTV) supported mode

Resolution	Horizontal Frequency (KHz)	Vertical Frequency (Hz)
720x480p	31.47	59.94
	31.50	60.00
720x576p	31.250	50.00
1280x720p	44.96	59.94
	45.00	60.00
	37.500	50.00
1920x1080i	33.72	59.94
	33.75	60.00
	28.125	50.00
1920x1080p	26.97	23.976
	27.00	24.00
	33.71	29.97
	33.75	30.00
	67.432	59.94
	67.50	60.00
	56.250	50.00

Component port connecting information

Component ports on the TV	Y	P _B	P _R
---------------------------	---	----------------	----------------

Video output ports on DVD player	Y	P _B	P _R
	Y	B-Y	R-Y
	Y	Cb	Cr
	Y	Pb	Pr

Component supported mode

Resolution	Horizontal Frequency (KHz)	Vertical Frequency (Hz)
720x480i	15.73	59.94
	15.73	60.00
720x480p	31.47	59.94
	31.50	60.00
720x576i	15.625	50.00
720x576p	31.250	50.00
1280x720p	44.96	59.94
	45.00	60.00
	37.500	50.00
1920x1080i	33.72	59.94
	33.75	60.00
	28.125	50.00
1920x1080p	26.97	23.976
	27.00	24.00
	33.71	29.97
	33.75	30.00
	67.432	59.94
	67.50	60.00
	56.250	50.00

Video Supported Formats

Extension name	File	Video Decoder	Audio Codec	Max Resolution
mpg, mpeg		MPEG1, MPEG2	MP2, MP3, Dolby Digital, LPCM	1920 x 1080 @ 30p (Only Motion JPEG 640x480@30p)
dat		MPEG1	MP2	
ts, trp, tp		MPEG2, H.264, AVS, VC1	MP2, MP3, Dolby Digital, AAC, HE-AAC	
vob		MPEG1, 2	MP2, MP3, Dolby Digital, LPCM	
mp4, mov		MPEG4, DivX 3.11, DivX 4.12, DivX 5.x, DivX 6, Xvid 1.00, Xvid 1.01, Xvid 1.02, Xvid 1.03, Xvid 1.10-beta1/2H.264	AAC, HE-AAC, MP3	
mkv		H.264, MPEG-1,2,4	MP2, MP3, Dolby Digital, AAC HE-AAC, LPCM	
divx, avi		MPEG2, MPEG4, DivX 3.11, DivX 4, DivX 5, DivX 6, Xvid 1.00, Xvid 1.01, Xvid 1.02, Xvid 1.03, Xvid 1.10-beta1/2H.264	MP2, MP3, Dolby Digital, LPCM, ADPCM, AAC, HE-AAC	
Motion JPEG (avi, mp4, mkv)		JPEG	LPCM, ADPCM	
asf, wmv		VC1	WMA	
flv		Sorenson H.263, H264	MP3, AAC	

IR CODES

Code (Hexa)	Function	Note	Code (Hexa)	Function	Note
08	⏻ (POWER)	Remote control Button (Power On/Off)	AB	GUIDE	Remote control Button
			0F	TV	Remote control Button
45	Q.MENU	Remote control Button	5B	EXIT	Remote control Button
43	SETTINGS	Remote control Button	D6	TV	Discrete IR Code (TV Input Selection)
0B	INPUT	Remote control Button	C4	POWER ON	Discrete IR Code (Only Power On)
10 - 19	Number Key 0-9	Remote control Button	C5	POWER OFF	Discrete IR Code (Only Power Off)
4C	- (Dash)/LIST	Remote control Button	5A	AV	Discrete IR Code (AV Input Selection)
1A	Q.VIEW	Remote control Button			
09	MUTE	Remote control Button	BF	COMPONENT1	Discrete IR Code (Component1 Input Selection)
02	VOL +	Remote control Button			
03	VOL -	Remote control Button	D4	COMPONENT2	Discrete IR Code (Component2 Input Selection)
00	CH ▲, +	Remote control Button			
01	CH ▼, -	Remote control Button	D5	RGB-PC	Discrete IR Code (RGB-PC Input Selection)
1E	FAV	Remote control Button			
40	▲	Remote control Button	CE	HDMI1	Discrete IR Code (HDMI1 Input Selection)
41	▼	Remote control Button			
07	<	Remote control Button	CC	HDMI2	Discrete IR Code (HDMI2 Input Selection)
06	>	Remote control Button			
44	OK	Remote control Button	E9	HDMI3	Discrete IR Code (HDMI3 Input Selection)
28	↶ (BACK)	Remote control Button			
79	RATIO	Remote control Button	76	Ratio 4:3	Discrete IR Code (Only 4:3 Mode)
95	ENERGY SAVING	Remote control Button			
7E	SIMPLINK	Remote control Button	77	Ratio 16:9	Discrete IR Code (Only 16:9 Mode)
AA	INFO	Remote control Button			
30	AV MODE	Remote control Button	AF	Ratio Zoom	Discrete IR Code (Only Zoom Mode)
72	RED	Remote control Button			
71	GREEN	Remote control Button			
63	YELLOW	Remote control Button			
61	BLUE	Remote control Button			
B1	■	Remote control Button			
B0	▶	Remote control Button			
BA	⏸ (FREEZE)	Remote control Button			
8E	▶▶	Remote control Button			
8F	◀◀	Remote control Button			

EXTERNAL CONTROL DEVICE SETUP

RS-232C Setup

Connect the RS-232C (serial port) input jack to an external control device (such as a computer or an A/V control system) to control the product's functions externally.

Connect the serial port of the control device to the RS-232C jack on the product back panel.

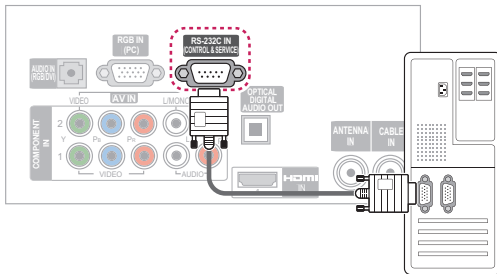

Type of connector; D-Sub 9-Pin Male

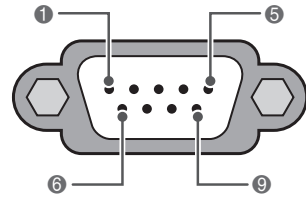

RS-232C IN
(CONTROL & SERVICE)

No.	Pin name
1	No connection
2	RXD (Receive data)
3	TXD (Transmit data)
4	DTR (DTE side ready)
5	GND
6	DSR (DCE side ready)
7	RTS (Ready to send)
8	CTS (Clear to send)
9	No Connection

NOTE

- RS-232C on this unit is intended to be used with third party RS-232C control hardware and software. The instructions below are provided to help with programming software or to test functionality using telenet software. RS-232C connection cables are not supplied with the product.

RS-232C configurations

7-Wire Configuration

(Serial female-female NULL modem cable)

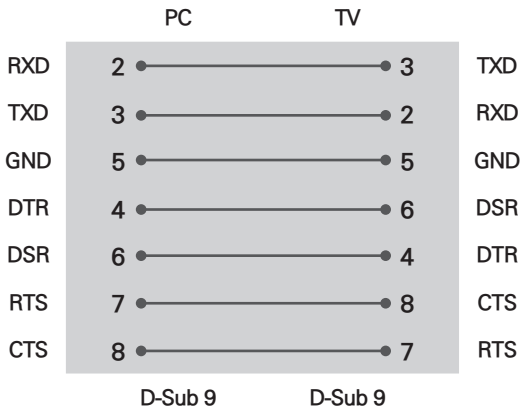

3-Wire Configurations(Not standard)

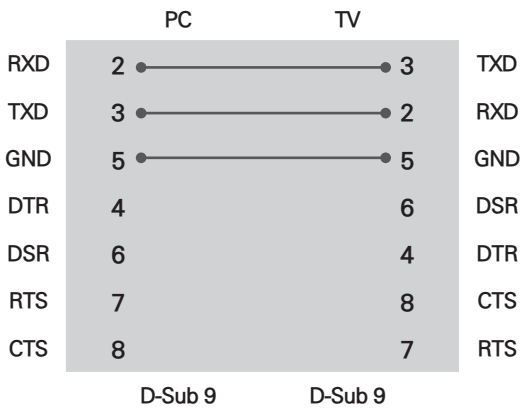

Set ID

Set ID number.

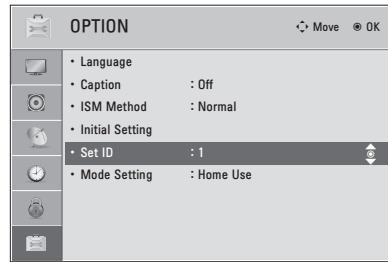

- 1 Press **SETTINGS** to access the main menus.
- 2 Press the Navigation buttons to scroll to **OPTION** and press **OK**.
- 3 Press the Navigation buttons to scroll to **Set ID** and press **OK**.
- 4 Scroll left or right to select a set ID number and select **CLOSE**. The adjustment range is 1-99.
- 5 When you are finished, press **EXIT**.

```
*Real data mapping
0 : Step 0
  :
A : Step 10 (SET ID 10)
  :
F : Step 15 (SET ID 15)
10 : Step 16 (SET ID 16)
  :
63 : Step 99 (SET ID 99)
64 : Step 100
```

Communication Parameters

- Baud rate: 9600 bps (UART)
- Data length: 8 bits
- Parity : None
- Stop bit: 1 bit
- Communication code: ASCII code
- Use a crossed (reverse) cable.

Command reference list

	COMMAND1	COMMAND2	DATA (Hexadecimal)		COMMAND1	COMMAND2	DATA (Hexadecimal)
01. Power	k	a	00 - 01	14. Treble	k	r	00 - 64
02. Input Select	x	b	(See p.96)	15. Bass	k	s	00 - 64
03. Aspect Ratio	k	c	(See p.96)	16. Balance	k	t	00 - 64
04. Screen Mute	k	d	00 - 01	17. Color Temperature	x	u	00 - 64
05. Volume Mute	k	e	00 - 01	18. ISM Method	j	p	(See p.97)
06. Volume Control	k	f	00 - 64	19. Energy Saving	j	q	(See p.97)
07. Contrast	k	g	00 - 64	20. Auto Configuration	j	u	(See p.97)
08. Brightness	k	h	00 - 64	22. Channel Add/Del	m	b	00 - 01
09. Color	k	i	00 - 64	23. Key	m	c	(See p.98)
10. Tint	k	j	00 - 64				
11. Sharpness	k	k	00 - 32				
12. OSD Select	k	l	00 - 01				
13. Remote Control Lock Mode	k	m	00 - 01				

	COMMAND1	COMMAND2	DATA00 (Hexadecimal)	DATA01 (Hexadecimal)	DATA02 (Hexadecimal)	DATA03 (Hexadecimal)	DATA04 (Hexadecimal)	DATA05 (Hexadecimal)
21. Channel Tuning	m	a	physical program high	major program low	major low	minor high	minor low	attribute

Transmission / Receiving protocol

Transmission

[Command1][Command2][][Set ID][][Data][Cr]

[Command 1] : First command to control the set.(j, k, m or x)

[Command 2] : Second command to control the set.

[Set ID] : You can adjust the set ID to choose desired set ID number in Option menu. Adjustment range is 1~ 99. When selecting Set ID '0', every connected the set is controlled. Set ID is indicated as decimal (1~ 99) on menu and as Hexa decimal (0x0~ 0x63) on transmission /receiving protocol.

[DATA] : To transmit the command data.

Transmit the 'FF' data to read status of command.

[Cr] : Carriage Return

ASCII code '0x0D'

[] : ASCII code 'space (0x20)'

* In this model, set will not send the status during the standby mode.

OK Acknowledgement

[Command2][][Set ID][][OK][Data][x]

The set transmits ACK (acknowledgement) based on this format when receiving normal data. At this time, if the data is data read mode, it indicates present status data. If the data is data write mode, it returns the data of the PC computer.

* In this model, set will not send the status during the standby mode.

* Data Format

[Command 2] : Use as command.

[Set ID] : Use the small character, if set ID is 10, it will send the '0', 'a'.

[DATA] : Use the small character, if data is 0 x ab, it will send the 'a', 'b'.

[OK] : Use the large character.

Error Acknowledgement

[Command2][][Set ID][][NG][Data][x]

The set transmits ACK (acknowledgement) based on this format when receiving abnormal data from non-viable functions or communication errors.

Data1: Illegal Code

Data2: Not supported function

Data3: Wait more time

* In this model, set will not send the status during the standby mode.

* Data Format

[Command 2] : Use as command.

[Set ID] : Use the small character, if set ID is 10, it will send the '0', 'a'.

[DATA] : Use the small character, if data is 0 x ab, it will send the 'a', 'b'.

[NG] : Use the large character

01. Power (Command: k a)

To control Power On/Off of the set.

Transmission [k][a][][Set ID][][Data][Cr]

Data 00: Power Off Data 01: Power On

Acknowledgement [a][][Set ID][][OK/NG][Data][x]

* In a like manner, if other functions transmit 'FF' data based on this format, Acknowledgement data feedback presents status about each function.

* Note: In this model, set will send the Acknowledge after power on processing completion.

There might be a time delay between command and acknowledge.

02. Input Select (Command: x b)

To select input source for set.

Transmission [x][b][][Set ID][][Data][Cr]

Data 00: DTV (Antenna)

Data 10: Analog (Antenna) Data 11: Analog (Cable)

Data 20: AV

Data 40: Component1 Data 41: Component2

Data 60: RGB-PC Data 90: HDMI1

Data 91: HDMI2 Data 92: HDMI3

Acknowledgement [b][][Set ID][][OK/NG][Data][x]

* Use the feature depending on your model.

03. Aspect Ratio (Command: k c)

To adjust the screen format.

Transmission [k][c][][Set ID][][Data][Cr]

Data 01: 4:3 Data: 09: Just scan

Data 02: 16:9 Data: 10: Cinema Zoom 1

Data 05: Zoom :

Data 06: Set by program Data 1F: Cinema Zoom16

Acknowledgement [c][][Set ID][][OK/NG][Data][x]

04. Screen Mute (Command: k d)

To select screen mute on/off.

Transmission [k][d][][Set ID][][Data][Cr]

Data 00: Screen mute off (Picture on), Video-out Mute off

Data 01: Screen mute on (Picture off)

Data 10: Video-out Mute on

Acknowledgement [d][][Set ID][][OK/NG][Data][x]

* In case of Video-out Mute on only, TV will display On Screen Display (OSD). But, in case of screen mute on, TV will not display On Screen Display (OSD).

05. Volume Mute (Command: k e)

To control volume mute on/off.

You can also adjust mute using the MUTE button on remote control.

Transmission [k][e][][Set ID][][Data][Cr]

Data 00: Volume mute on (Volume off)

Data 01: Volume mute off (Volume on)

Acknowledgement [e][][Set ID][][OK/NG][Data][x]

06. Volume Control (Command: k f)

To adjust volume.

You can also adjust volume with the volume buttons on remote control.

Transmission [k][f][][Set ID][][Data][Cr]

Data Min: 00 ~ Max: 64 (*transmit by Hexadecimal code)

*Refer to "Real data mapping".

Acknowledgement [f][][Set ID][][OK/NG][Data][x]

07. Contrast (Command: k g)

To adjust screen contrast.

You can also adjust contrast in the PICTURE menu.

Transmission [k][g][][Set ID][][Data][Cr]

Data Min: 00 ~ Max: 64 (*transmit by Hexadecimal code)

*Refer to "Real data mapping".

Acknowledgement [g][][Set ID][][OK/NG][Data][x]

08. Brightness (Command: k h)

To adjust screen brightness.

You can also adjust brightness in the PICTURE menu.

Transmission [k][h][][Set ID][][Data][Cr]

Data Min: 00 ~ Max: 64 (*transmit by Hexadecimal code)

*Refer to "Real data mapping".

Acknowledgement [h][][Set ID][][OK/NG][Data][x]

09. Color (Command: k i)

To adjust screen color.

You can also adjust color in the PICTURE menu.

Transmission [k][i][][Set ID][][Data][Cr]

Data Min: 00 ~ Max: 64 (*transmit by Hexadecimal code)

*Refer to "Real data mapping".

Acknowledgement [i][][Set ID][][OK/NG][Data][x]

10. Tint (Command: k j)

To adjust screen tint.

You can also adjust tint in the PICTURE menu.

Transmission [k][j][][Set ID][][Data][Cr]

Data Red: 00 ~ Green: 64 (*transmit by Hexadecimal code)

*Refer to "Real data mapping".

Acknowledgement [j][][Set ID][][OK/NG][Data][x]

11. Sharpness (Command: k k)

To adjust screen sharpness.

You can also adjust sharpness in the PICTURE menu.

Transmission [k][k][][Set ID][][Data][Cr]

Data Min: 00 ~ Max: 32 (*transmit by Hexadecimal code)

*Refer to "Real data mapping".

Acknowledgement [k][][Set ID][][OK/NG][Data][x]

12. OSD Select (Command: k l)

To select OSD (On Screen Display) on/off.

Transmission [k][l][][Set ID][][Data][Cr]

Data 00: OSD off Data 01: OSD on

Acknowledgement [l][][Set ID][][OK/NG][Data][x]

13. Remote Control Lock Mode (Command: k m)

To lock the remote control and the front panel controls on the set.

Transmission [k][m][][Set ID][][Data][Cr]

Data 00: Lock off Data 01: Lock on

Acknowledgement [m][][Set ID][][OK/NG][Data][x]

If you're not using the remote control and front panel controls on the Monitor set, use this mode. When main power is on/off, remote control lock is released. If Key Lock is on in the standby mode, TV will not turn on by POWER button of remote control and on the TV.

14. Treble (Command: k r)

To adjust treble.

You can also adjust treble in the AUDIO menu.

Transmission [k][r][][Set ID][][Data][Cr]

Data Min: 00 ~ Max: 64 (*transmit by Hexadecimal code)

*Refer to "Real data mapping".

Acknowledgement [r][][Set ID][][OK/NG][Data][x]

15. Bass (Command: k s)

To adjust bass.

You can also adjust bass in the AUDIO menu.

Transmission [k][s][][Set ID][][Data][Cr]

Data Min: 00 ~ Max: 64 (*transmit by Hexadecimal code)

*Refer to "Real data mapping".

Acknowledgement [s][][Set ID][][OK/NG][Data][x]

16. Balance (Command: k t)

To adjust balance.

You can also adjust balance in the AUDIO menu.

Transmission [k][t][][Set ID][][Data][Cr]

Data Min: 00 ~ Max: 64 (*transmit by Hexadecimal code)

*Refer to "Real data mapping".

Acknowledgement [t][][Set ID][][OK/NG][Data][x]

17. Color Temperature (Command: x u)

To adjust color temperature.

You can also adjust color temperature in the PICTURE menu.

Transmission [x][u][][Set ID][][Data][Cr]

Data Min: 00 ~ Max: 64 (*transmit by Hexadecimal code)

*Refer to "Real data mapping".

Acknowledgement [u][][Set ID][][OK/NG][Data][x]

18. ISM Method (Command: j p)

To avoid having a fixed image remain on screen.

Transmission [j][p][][Set ID][][Data][Cr]

Data 02: Orbiter

08: Normal

20: Color Wash

Acknowledgement [p][][Set ID][][OK/NG][Data][x]

19. Energy Saving (Command: j q)

To control the energy saving function.

Transmission [j][q][][Set ID][][Data][Cr]

Data 00: off

01: Minimum

02: Medium

03: Maximum

04: Auto/Intelligent sensor (depending on model)

05: Screen off

Acknowledgement [q][][Set ID][][OK/NG][Data][x]

20. Auto Configuration (Command: j u)

To adjust picture position and minimize image shaking automatically. Auto configuration only works in RGB-PC mode.

Transmission [j][u][][Set ID][][Data][Cr]

Data 01: To set

Acknowledgement [u][][Set ID][][OK/NG][Data][x]

21. Channel Tuning (Command: m a)

To tune channel to following physical/major/minor number.

Transmission [m][a][][Set ID][][Data00][][Data01][][Data02][][Data03][][Data04][][Data05][Cr]

Digital channels have a Physical, Major, and Minor channel number. The Physical number is the actual digital channel number, the Major is the number that the channel should be mapped to, and the Minor is the sub-channel. Since the DTV tuner automatically maps the channel to the Major number, the Physical number is not required when sending a command.

Data 00: Physical Channel Number

Analog air: 01~69, Analog cable: 01~135

DTV air: 01~69

Data 01 & 02: Major Channel Number

Data 01: High byte Data 02: Low byte

Two bytes are available for the Major and Minor, normally only the second byte is used.

Data 03 & 04: Minor Channel Number

Not needed for NTSC.

The table above lists the binary code which must be converted to Hexadecimal before sending. For example:

The binary code to tune the sub source to an NTSC cable channel is "1000 0001", which translates to "81" in Hex.

* 7th bit : For which source do you want to change the channel.

* 6th bit: Use a two part or one part channel. Most cases just use 0 since it's ignored when using NTSC.

- * 5th bit: Use 0 with NTSC since it can only use the physical channel number. Normally use 1 for DTV since most times it doesn't matter what the physical number is.
- * 4th bit: Set to 0.
- * 3-0 bits: Choose signal type.

* Tune Command Examples:

1. Tune to the analog (NTSC) cable channel 35.

Data 00 = Physical of 35 = 23

Data 01 & 02 = No Major = 00 00

Data 03 & 04 = No Minor = 00 00

Data 05 = 0000 0001 in binary = 01

Total = ma 00 23 00 00 00 00 01

2. Tune to the digital (DTV) local channel 30-3.

Data 00 = Don't know Physical = 00

Data 01 & 02 = Major is 30 = 00 1E

Data 03 & 04 = Minor is 3 = 00 03

Data 05 = 0010 0010 in binary = 22

Total = ma 00 00 00 1E 00 03 22

22. Channel Add/Del (Command: m b)

To add and delete the channels.

Transmission [m][b][][Set ID][][Data][Cr]

Data 00: Channel Delete Data 01: Channel Add

Acknowledgement [b][][Set ID][][OK/NG][Data][x]

23. Key (Command: m c)

To send IR remote key code.

Transmission [m][c][][Set ID][][Data][Cr]

Acknowledgement [c][][Set ID][][OK/NG][Data][x]

When TV is in the standby mode, TV will turn on by POWER button of remote control only.

* Table List (Channel Tuning)

7	Main/Sub Picture	6	Two/One Part Channel	5	Using Physical Channel	4 Reserved	3	2	1	0	Step
0	Main	0	Two	0	Use	x	0	0	0	0	NTSC Air
1	Sub	1	One	1	No Use	x	0	0	0	1	NTSC Cable
						x	0	0	1	0	DTV Air
						x	0	0	1	1	DTV Cable_std
						x	0	1	0	0	DTV Cable_hrc
						x	0	1	0	1	DTV Cable_irc
						x	0	1	1	0	DTV cable_auto
						x	0	1	1	1	Reserved
						x	x	x	x	x	...
						x	1	1	1	1	Reserved

OPEN SOURCE LICENSE

Open source software notice

Please be informed that LG Electronics products may contain open source software listed in the tables below.

License	Component
OpenSSL license	- openssl
MIT license	- libcurl - ncurses
expat license	- expat
Freetype license	- freetype
JPEG license	- libjpeg
Zlib/libpng license	- libmng - libpng - md5 checksum - tinyxml - zlib
X.net license	- libicu
BSD license	- strace - xySSL
RSA data security license	- MD5

LG Electronics products may also contain open source software listed as Components in the table below, and you may download the complete source code thereof free of charge, from LG Electronics website (<http://opensource.lge.com>) for a period of three (3) years from our last shipment of this product. Please be informed that the open source software is subject to the terms and conditions of the applicable open source licenses, which are provided to you hereinbelow.

License	Component
GNU GPL v2.0	- Linux kernel 2.6 - busybox - e2fsprogs - gdbserver - jfsutils - mtd-utils - procps - u-boot - udhcpc
GNU LGPL v2.1	- directFB - gconv - glibc
MPL 1.1	- nanox

GNU GENERAL PUBLIC LICENSE

Version 2, June 1991

Copyright (C) 1989, 1991 Free Software Foundation, Inc.
51 Franklin Street, Fifth Floor, Boston, MA 02110-1301, USA
Everyone is permitted to copy and distribute verbatim copies
of this license document, but changing it is not allowed.

Preamble

The licenses for most software are designed to take away your freedom to share and change it. By contrast, the GNU General Public License is intended to guarantee your freedom to share and change free software—to make sure the software is free for all its users. This General Public License applies to most of the Free Software Foundation’s software and to any other program whose authors commit to using it. (Some other Free Software Foundation software is covered by the GNU Lesser General Public License instead.) You can apply it to your programs, too.

When we speak of free software, we are referring to freedom, not price. Our General Public Licenses are designed to make sure that you have the freedom to distribute copies of free software (and charge for this service if you wish), that you receive source code or can get it if you want it, that you can change the software or use pieces of it in new free programs; and that you know you can do these things.

To protect your rights, we need to make restrictions that forbid anyone to deny you these rights or to ask you to surrender the rights. These restrictions translate to certain responsibilities for you if you distribute copies of the software, or if you modify it.

For example, if you distribute copies of such a program, whether gratis or for a fee, you must give the recipients all the rights that you have. You must make sure that they, too, receive or can get the source code. And you must show them these terms so they know their rights.

We protect your rights with two steps: (1) copyright the software, and (2) offer you this license which gives you legal permission to copy, distribute and/or modify the software.

Also, for each author’s protection and ours, we want to make certain that everyone understands that there is no warranty for this free software. If the software is modified by someone else and passed on, we want its recipients to know that what they have is not the original, so that any problems introduced by others will not reflect on the original authors’ reputations.

Finally, any free program is threatened constantly by software patents. We wish to avoid the danger that redistributors of a free program will individually obtain patent licenses, in effect making the program proprietary. To prevent this, we have made it clear that any patent must be licensed for everyone’s free use or not licensed at all.

The precise terms and conditions for copying, distribution and modification follow.

TERMS AND CONDITIONS FOR COPYING, DISTRIBUTION AND MODIFICATION

0. This License applies to any program or other work which contains a notice placed by the copyright holder saying it may be distributed under the terms of this General Public License. The “Program”, below, refers to any such program or work, and a “work based on the Program” means either the Program or any derivative work under copyright law: that is to say, a work containing the Program or a portion of it, either verbatim or with modifications and/or translated into another language. (Hereinafter, translation is included without limitation in the term “modification”.) Each licensee is addressed as “you”.

Activities other than copying, distribution and modification are not covered by this License; they are outside its scope. The act of running the Program is not restricted, and the output from the Program is covered only if its contents constitute a work based on the Program (independent of having been made by running the Program). Whether that is true depends on what the Program does.

1. You may copy and distribute verbatim copies of the Program's source code as you receive it, in any medium, provided that you conspicuously and appropriately publish on each copy an appropriate copyright notice and disclaimer of warranty; keep intact all the notices that refer to this License and to the absence of any warranty; and give any other recipients of the Program a copy of this License along with the Program.

You may charge a fee for the physical act of transferring a copy, and you may at your option offer warranty protection in exchange for a fee.

2. You may modify your copy or copies of the Program or any portion of it, thus forming a work based on the Program, and copy and distribute such modifications or work under the terms of Section 1 above, provided that you also meet all of these conditions:

a) You must cause the modified files to carry prominent notices stating that you changed the files and the date of any change.

b) You must cause any work that you distribute or publish, that in whole or in part contains or is derived from the Program or any part thereof, to be licensed as a whole at no charge to all third parties under the terms of this License.

c) If the modified program normally reads commands interactively when run, you must cause it, when started running for such interactive use in the most ordinary way, to print or display an announcement including an appropriate copyright notice and a notice that there is no warranty (or else, saying that you provide a warranty) and that users may redistribute the program under these conditions, and telling the user how to view a copy of this License. (Exception: if the Program itself is interactive but does not normally print such an announcement, your work based on the Program is not required to print an announcement.)

These requirements apply to the modified work as a whole. If identifiable sections of that work are not derived from the Program, and can be reasonably considered independent and separate works in themselves, then this License, and its terms, do not apply to those sections when you distribute them as separate works. But when you distribute the same sections as part of a whole which is a work based on the Program, the distribution of the whole must be on the terms of this License, whose permissions for other licensees extend to the entire whole, and thus to each and every part regardless of who wrote it.

Thus, it is not the intent of this section to claim rights or contest your rights to work written entirely by you; rather, the intent is to exercise the right to control the distribution of derivative or collective works based on the Program.

In addition, mere aggregation of another work not based on the Program with the Program (or with a work based on the Program) on a volume of a storage or distribution medium does not bring the other work under the scope of this License.

3. You may copy and distribute the Program (or a work based on it, under Section 2) in object code or executable form under the terms of Sections 1 and 2 above provided that you also do one of the following:

a) Accompany it with the complete corresponding machine-readable source code, which must be distributed under the terms of Sections 1 and 2 above on a medium customarily used for software interchange; or,

b) Accompany it with a written offer, valid for at least three years, to give any third party, for a charge no more than your cost of physically performing source distribution, a complete machine-readable copy of the corresponding source code, to be distributed under the terms of Sections 1 and 2 above on a medium customarily used for software interchange; or,

c) Accompany it with the information you received as to the offer to distribute corresponding source code. (This alternative is allowed only for noncommercial distribution and only if you received the program in object code or executable form with such an offer, in accord with Subsection b above.)

The source code for a work means the preferred form of the work for making modifications to it. For an executable work, complete source code means all the source code for all modules it contains, plus any associated interface definition files, plus the scripts used to control compilation and installation of the executable. However, as a special exception, the source code distributed need not include anything that is normally distributed (in either source or binary form) with the major components (compiler, kernel, and so on) of the operating system on which the executable runs, unless that component itself accompanies the executable.

If distribution of executable or object code is made by offering access to copy from a designated place, then offering equivalent access to copy the source code from the same place counts as distribution of the source code, even though third parties are not compelled to copy the source along with the object code.

4. You may not copy, modify, sublicense, or distribute the Program except as expressly provided under this License. Any attempt otherwise to copy, modify, sublicense or distribute the Program is void, and will automatically terminate your rights under this License. However, parties who have received copies, or rights, from you under this License will not have their licenses terminated so long as such parties remain in full compliance.

5. You are not required to accept this License, since you have not signed it. However, nothing else grants you permission to modify or distribute the Program or its derivative works. These actions are prohibited by law if you do not accept this License. Therefore, by modifying or distributing the Program (or any work based on the Program), you indicate your acceptance of this License to do so, and all its terms and conditions for copying, distributing or modifying the Program or works based on it.

6. Each time you redistribute the Program (or any work based on the Program), the recipient automatically receives a license from the original licensor to copy, distribute or modify the Program subject to these terms and conditions. You may not impose any further restrictions on the recipients' exercise of the rights granted herein. You are not responsible for enforcing compliance by third parties to this License.

7. If, as a consequence of a court judgment or allegation of patent infringement or for any other reason (not limited to patent issues), conditions are imposed on you (whether by court order, agreement or otherwise) that contradict the conditions of this License, they do not excuse you from the conditions of this License. If you cannot distribute so as to satisfy simultaneously your obligations under this License and any other pertinent obligations, then as a consequence you may not distribute the Program at all. For example, if a patent license would not permit royalty-free redistribution of the Program by all those who receive copies directly or indirectly through you, then the only way you could satisfy both it and this License would be to refrain entirely from distribution of the Program.

If any portion of this section is held invalid or unenforceable under any particular circumstance, the balance of the section is intended to apply and the section as a whole is intended to apply in other circumstances.

It is not the purpose of this section to induce you to infringe any patents or other property right claims or to contest validity of any such claims; this section has the sole purpose of protecting the integrity of the free software distribution system, which is implemented by public license practices. Many people have made generous contributions to the wide range of software distributed through that system in reliance on consistent application of that system; it is up to the author/donor to decide if he or she is willing to distribute software through any other system and a licensee cannot impose that choice.

This section is intended to make thoroughly clear what is believed to be a consequence of the rest of this License.

8. If the distribution and/or use of the Program is restricted in certain countries either by patents or by copyrighted interfaces, the original copyright holder who places the Program under this License may add an explicit geographical distribution limitation excluding those countries, so that distribution is permitted only in or among countries not thus excluded. In such case, this License incorporates the limitation as if written in the body of this License.

9. The Free Software Foundation may publish revised and/or new versions of the General Public License from time to time. Such new versions will be similar in spirit to the present version, but may differ in detail to address new problems or concerns.

Each version is given a distinguishing version number. If the Program specifies a version number of this License which

applies to it and “any later version”, you have the option of following the terms and conditions either of that version or of any later version published by the Free Software Foundation. If the Program does not specify a version number of this License, you may choose any version ever published by the Free Software Foundation.

10. If you wish to incorporate parts of the Program into other free programs whose distribution conditions are different, write to the author to ask for permission. For software which is copyrighted by the Free Software Foundation, write to the Free Software Foundation; we sometimes make exceptions for this. Our decision will be guided by the two goals of preserving the free status of all derivatives of our free software and of promoting the sharing and reuse of software generally.

NO WARRANTY

11. BECAUSE THE PROGRAM IS LICENSED FREE OF CHARGE, THERE IS NO WARRANTY FOR THE PROGRAM, TO THE EXTENT PERMITTED BY APPLICABLE LAW. EXCEPT WHEN OTHERWISE STATED IN WRITING THE COPYRIGHT HOLDERS AND/OR OTHER PARTIES PROVIDE THE PROGRAM “AS IS” WITHOUT WARRANTY OF ANY KIND, EITHER EXPRESSED OR IMPLIED, INCLUDING, BUT NOT LIMITED TO, THE IMPLIED WARRANTIES OF MERCHANTABILITY AND FITNESS FOR A PARTICULAR PURPOSE. THE ENTIRE RISK AS TO THE QUALITY AND PERFORMANCE OF THE PROGRAM IS WITH YOU. SHOULD THE PROGRAM PROVE DEFECTIVE, YOU ASSUME THE COST OF ALL NECESSARY SERVICING, REPAIR OR CORRECTION.

12. IN NO EVENT UNLESS REQUIRED BY APPLICABLE LAW OR AGREED TO IN WRITING WILL ANY COPYRIGHT HOLDER, OR ANY OTHER PARTY WHO MAY MODIFY AND/OR REDISTRIBUTE THE PROGRAM AS PERMITTED ABOVE, BE LIABLE TO YOU FOR DAMAGES, INCLUDING ANY GENERAL, SPECIAL, INCIDENTAL OR CONSEQUENTIAL DAMAGES ARISING OUT OF THE USE OR INABILITY TO USE THE PROGRAM (INCLUDING BUT NOT LIMITED TO LOSS OF DATA OR DATA BEING RENDERED INACCURATE OR LOSSES SUSTAINED BY YOU OR THIRD PARTIES OR A FAILURE OF THE PROGRAM TO OPERATE WITH ANY OTHER PROGRAMS), EVEN IF SUCH HOLDER OR OTHER PARTY HAS BEEN ADVISED OF THE POSSIBILITY OF SUCH DAMAGES.

END OF TERMS AND CONDITIONS

GNU Lesser General Public License

Version 2.1, February 1999

Copyright (C) 1991, 1999 Free Software Foundation, Inc. 59 Temple Place, Suite 330, Boston, MA 02111-1307 USA
Everyone is permitted to copy and distribute verbatim copies of this license document, but changing it is not allowed.

[This is the first released version of the Lesser GPL. It also counts as the successor of the GNU Library Public License, version 2, hence the version number 2.1.]

Preamble

The licenses for most software are designed to take away your freedom to share and change it. By contrast, the GNU General Public Licenses are intended to guarantee your freedom to share and change free software—to make sure the software is free for all its users.

This license, the Lesser General Public License, applies to some specially designated software packages—typically libraries—of the Free Software Foundation and other authors who decide to use it. You can use it too, but we suggest you first think carefully about whether this license or the ordinary General Public License is the better strategy to use in any particular case, based on the explanations below.

When we speak of free software, we are referring to freedom of use, not price. Our General Public Licenses are designed to make sure that you have the freedom to distribute copies of free software (and charge for this service if you wish); that you receive source code or can get it if you want it; that you can change the software and use pieces of it in new free programs; and that you are informed that you can do these things.

To protect your rights, we need to make restrictions that forbid distributors to deny you these rights or to ask you to

surrender these rights. These restrictions translate to certain responsibilities for you if you distribute copies of the library or if you modify it.

For example, if you distribute copies of the library, whether gratis or for a fee, you must give the recipients all the rights that we gave you. You must make sure that they, too, receive or can get the source code. If you link other code with the library, you must provide complete object files to the recipients, so that they can relink them with the library after making changes to the library and recompiling it. And you must show them these terms so they know their rights.

We protect your rights with a two-step method: (1) we copyright the library, and (2) we offer you this license, which gives you legal permission to copy, distribute and/or modify the library.

To protect each distributor, we want to make it very clear that there is no warranty for the free library. Also, if the library is modified by someone else and passed on, the recipients should know that what they have is not the original version, so that the original author's reputation will not be affected by problems that might be introduced by others.

Finally, software patents pose a constant threat to the existence of any free program. We wish to make sure that a company cannot effectively restrict the users of a free program by obtaining a restrictive license from a patent holder. Therefore, we insist that any patent license obtained for a version of the library must be consistent with the full freedom of use specified in this license.

Most GNU software, including some libraries, is covered by the ordinary GNU General Public License. This license, the GNU Lesser General Public License, applies to certain designated libraries, and is quite different from the ordinary General Public License. We use this license for certain libraries in order to permit linking those libraries into non-free programs.

When a program is linked with a library, whether statically or using a shared library, the combination of the two is legally speaking a combined work, a derivative of the original library. The ordinary General Public License therefore permits such linking only if the entire combination fits its criteria of freedom. The Lesser General Public License permits more lax criteria for linking other code with the library.

We call this license the "Lesser" General Public License because it does Less to protect the user's freedom than the ordinary General Public License. It also provides other free software developers Less of an advantage over competing non-free programs. These disadvantages are the reason we use the ordinary General Public License for many libraries. However, the Lesser license provides advantages in certain special circumstances.

For example, on rare occasions, there may be a special need to encourage the widest possible use of a certain library, so that it becomes a de-facto standard. To achieve this, non-free programs must be allowed to use the library. A more frequent case is that a free library does the same job as widely used non-free libraries. In this case, there is little to gain by limiting the free library to free software only, so we use the Lesser General Public License.

In other cases, permission to use a particular library in non-free programs enables a greater number of people to use a large body of free software. For example, permission to use the GNU C Library in non-free programs enables many more people to use the whole GNU operating system, as well as its variant, the GNU/Linux operating system.

Although the Lesser General Public License is Less protective of the users' freedom, it does ensure that the user of a program that is linked with the Library has the freedom and the wherewithal to run that program using a modified version of the Library.

The precise terms and conditions for copying, distribution and modification follow. Pay close attention to the difference between a "work based on the library" and a "work that uses the library". The former contains code derived from the library, whereas the latter must be combined with the library in order to run.

TERMS AND CONDITIONS FOR COPYING, DISTRIBUTION AND MODIFICATION

0. This License Agreement applies to any software library or other program which contains a notice placed by the copyright holder or other authorized party saying it may be distributed under the terms of this Lesser General Public License (also called "this License"). Each licensee is addressed as "you".

A “library” means a collection of software functions and/or data prepared so as to be conveniently linked with application programs (which use some of those functions and data) to form executables.

The “Library”, below, refers to any such software library or work which has been distributed under these terms. A “work based on the Library” means either the Library or any derivative work under copyright law: that is to say, a work containing the Library or a portion of it, either verbatim or with modifications and/or translated straightforwardly into another language. (Hereinafter, translation is included without limitation in the term “modification”.)

“Source code” for a work means the preferred form of the work for making modifications to it. For a library, complete source code means all the source code for all modules it contains, plus any associated interface definition files, plus the scripts used to control compilation and installation of the library.

Activities other than copying, distribution and modification are not covered by this License; they are outside its scope. The act of running a program using the Library is not restricted, and output from such a program is covered only if its contents constitute a work based on the Library (independent of the use of the Library in a tool for writing it). Whether that is true depends on what the Library does and what the program that uses the Library does.

1. You may copy and distribute verbatim copies of the Library’s complete source code as you receive it, in any medium, provided that you conspicuously and appropriately publish on each copy an appropriate copyright notice and disclaimer of warranty; keep intact all the notices that refer to this License and to the absence of any warranty; and distribute a copy of this License along with the Library.

You may charge a fee for the physical act of transferring a copy, and you may at your option offer warranty protection in exchange for a fee.

2. You may modify your copy or copies of the Library or any portion of it, thus forming a work based on the Library, and copy and distribute such modifications or work under the terms of Section 1 above, provided that you also meet all of these conditions:

- a) The modified work must itself be a software library.
- b) You must cause the files modified to carry prominent notices stating that you changed the files and the date of any change.
- c) You must cause the whole of the work to be licensed at no charge to all third parties under the terms of this License.
- d) If a facility in the modified Library refers to a function or a table of data to be supplied by an application program that uses the facility, other than as an argument passed when the facility is invoked, then you must make a good faith effort to ensure that, in the event an application does not supply such function or table, the facility still operates, and performs whatever part of its purpose remains meaningful.

(For example, a function in a library to compute square roots has a purpose that is entirely well-defined independent of the application. Therefore, Subsection 2d requires that any application-supplied function or table used by this function must be optional: if the application does not supply it, the square root function must still compute square roots.)

These requirements apply to the modified work as a whole. If identifiable sections of that work are not derived from the Library, and can be reasonably considered independent and separate works in themselves, then this License, and its terms, do not apply to those sections when you distribute them as separate works. But when you distribute the same sections as part of a whole which is a work based on the Library, the distribution of the whole must be on the terms of this License, whose permissions for other licensees extend to the entire whole, and thus to each and every part regardless of who wrote it.

Thus, it is not the intent of this section to claim rights or contest your rights to work written entirely by you; rather, the intent is to exercise the right to control the distribution of derivative or collective works based on the Library.

In addition, mere aggregation of another work not based on the Library with the Library (or with a work based on the

Library) on a volume of a storage or distribution medium does not bring the other work under the scope of this License.

3. You may opt to apply the terms of the ordinary GNU General Public License instead of this License to a given copy of the Library. To do this, you must alter all the notices that refer to this License, so that they refer to the ordinary GNU General Public License, version 2, instead of to this License. (If a newer version than version 2 of the ordinary GNU General Public License has appeared, then you can specify that version instead if you wish.) Do not make any other change in these notices.

Once this change is made in a given copy, it is irreversible for that copy, so the ordinary GNU General Public License applies to all subsequent copies and derivative works made from that copy.

This option is useful when you wish to copy part of the code of the Library into a program that is not a library.

4. You may copy and distribute the Library (or a portion or derivative of it, under Section 2) in object code or executable form under the terms of Sections 1 and 2 above provided that you accompany it with the complete corresponding machine-readable source code, which must be distributed under the terms of Sections 1 and 2 above on a medium customarily used for software interchange.

If distribution of object code is made by offering access to copy from a designated place, then offering equivalent access to copy the source code from the same place satisfies the requirement to distribute the source code, even though third parties are not compelled to copy the source along with the object code.

5. A program that contains no derivative of any portion of the Library, but is designed to work with the Library by being compiled or linked with it, is called a “work that uses the Library”. Such a work, in isolation, is not a derivative work of the Library, and therefore falls outside the scope of this License.

However, linking a “work that uses the Library” with the Library creates an executable that is a derivative of the Library (because it contains portions of the Library), rather than a “work that uses the library”. The executable is therefore covered by this License. Section 6 states terms for distribution of such executables.

When a “work that uses the Library” uses material from a header file that is part of the Library, the object code for the work may be a derivative work of the Library even though the source code is not. Whether this is true is especially significant if the work can be linked without the Library, or if the work is itself a library. The threshold for this to be true is not precisely defined by law.

If such an object file uses only numerical parameters, data structure layouts and accessors, and small macros and small inline functions (ten lines or less in length), then the use of the object file is unrestricted, regardless of whether it is legally a derivative work. (Executables containing this object code plus portions of the Library will still fall under Section 6.)

Otherwise, if the work is a derivative of the Library, you may distribute the object code for the work under the terms of Section 6. Any executables containing that work also fall under Section 6, whether or not they are linked directly with the Library itself.

6. As an exception to the Sections above, you may also combine or link a “work that uses the Library” with the Library to produce a work containing portions of the Library, and distribute that work under terms of your choice, provided that the terms permit modification of the work for the customer’s own use and reverse engineering for debugging such modifications.

You must give prominent notice with each copy of the work that the Library is used in it and that the Library and its use are covered by this License. You must supply a copy of this License. If the work during execution displays copyright notices, you must include the copyright notice for the Library among them, as well as a reference directing the user to the copy of this License. Also, you must do one of these things:

a) Accompany the work with the complete corresponding machine-readable source code for the Library including whatever changes were used in the work (which must be distributed under Sections 1 and 2 above); and, if the work is an executable linked with the Library, with the complete machine-readable “work that uses the Library”, as object code and/

or source code, so that the user can modify the Library and then relink to produce a modified executable containing the modified Library. (It is understood that the user who changes the contents of definitions files in the Library will not necessarily be able to recompile the application to use the modified definitions.)

b) Use a suitable shared library mechanism for linking with the Library. A suitable mechanism is one that (1) uses at run time a copy of the library already present on the user's computer system, rather than copying library functions into the executable, and (2) will operate properly with a modified version of the library, if the user installs one, as long as the modified version is interface-compatible with the version that the work was made with.

c) Accompany the work with a written offer, valid for at least three years, to give the same user the materials specified in Subsection 6a, above, for a charge no more than the cost of performing this distribution.

d) If distribution of the work is made by offering access to copy from a designated place, offer equivalent access to copy the above specified materials from the same place.

e) Verify that the user has already received a copy of these materials or that you have already sent this user a copy.

For an executable, the required form of the "work that uses the Library" must include any data and utility programs needed for reproducing the executable from it. However, as a special exception, the materials to be distributed need not include anything that is normally distributed (in either source or binary form) with the major components (compiler, kernel, and so on) of the operating system on which the executable runs, unless that component itself accompanies the executable.

It may happen that this requirement contradicts the license restrictions of other proprietary libraries that do not normally accompany the operating system. Such a contradiction means you cannot use both them and the Library together in an executable that you distribute.

7. You may place library facilities that are a work based on the Library side-by-side in a single library together with other library facilities not covered by this License, and distribute such a combined library, provided that the separate distribution of the work based on the Library and of the other library facilities is otherwise permitted, and provided that you do these two things:

a) Accompany the combined library with a copy of the same work based on the Library, uncombined with any other library facilities. This must be distributed under the terms of the Sections above.

b) Give prominent notice with the combined library of the fact that part of it is a work based on the Library, and explaining where to find the accompanying uncombined form of the same work.

8. You may not copy, modify, sublicense, link with, or distribute the Library except as expressly provided under this License. Any attempt otherwise to copy, modify, sublicense, link with, or distribute the Library is void, and will automatically terminate your rights under this License. However, parties who have received copies, or rights, from you under this License will not have their licenses terminated so long as such parties remain in full compliance.

9. You are not required to accept this License, since you have not signed it. However, nothing else grants you permission to modify or distribute the Library or its derivative works. These actions are prohibited by law if you do not accept this License. Therefore, by modifying or distributing the Library (or any work based on the Library), you indicate your acceptance of this License to do so, and all its terms and conditions for copying, distributing or modifying the Library or works based on it.

10. Each time you redistribute the Library (or any work based on the Library), the recipient automatically receives a license from the original licensor to copy, distribute, link with or modify the Library subject to these terms and conditions. You may not impose any further restrictions on the recipients' exercise of the rights granted herein. You are not responsible for enforcing compliance by third parties with this License.

11. If, as a consequence of a court judgment or allegation of patent infringement or for any other reason (not limited to patent issues), conditions are imposed on you (whether by court order, agreement or otherwise) that contradict the con

ditions of this License, they do not excuse you from the conditions of this License. If you cannot distribute so as to satisfy simultaneously your obligations under this License and any other pertinent obligations, then as a consequence you may not distribute the Library at all. For example, if a patent license would not permit royalty-free redistribution of the Library by all those who receive copies directly or indirectly through you, then the only way you could satisfy both it and this License would be to refrain entirely from distribution of the Library.

If any portion of this section is held invalid or unenforceable under any particular circumstance, the balance of the section is intended to apply, and the section as a whole is intended to apply in other circumstances.

It is not the purpose of this section to induce you to infringe any patents or other property right claims or to contest validity of any such claims; this section has the sole purpose of protecting the integrity of the free software distribution system which is implemented by public license practices. Many people have made generous contributions to the wide range of software distributed through that system in reliance on consistent application of that system; it is up to the author/donor to decide if he or she is willing to distribute software through any other system and a licensee cannot impose that choice.

This section is intended to make thoroughly clear what is believed to be a consequence of the rest of this License.

12. If the distribution and/or use of the Library is restricted in certain countries either by patents or by copyrighted interfaces, the original copyright holder who places the Library under this License may add an explicit geographical distribution limitation excluding those countries, so that distribution is permitted only in or among countries not thus excluded. In such case, this License incorporates the limitation as if written in the body of this License.

13. The Free Software Foundation may publish revised and/or new versions of the Lesser General Public License from time to time. Such new versions will be similar in spirit to the present version, but may differ in detail to address new problems or concerns.

Each version is given a distinguishing version number. If the Library specifies a version number of this License which applies to it and “any later version”, you have the option of following the terms and conditions either of that version or of any later version published by the Free Software Foundation. If the Library does not specify a license version number, you may choose any version ever published by the Free Software Foundation.

14. If you wish to incorporate parts of the Library into other free programs whose distribution conditions are incompatible with these, write to the author to ask for permission. For software which is copyrighted by the Free Software Foundation, write to the Free Software Foundation; we sometimes make exceptions for this. Our decision will be guided by the two goals of preserving the free status of all derivatives of our free software and of promoting the sharing and reuse of software generally.

NO WARRANTY

15. BECAUSE THE LIBRARY IS LICENSED FREE OF CHARGE, THERE IS NO WARRANTY FOR THE LIBRARY, TO THE EXTENT PERMITTED BY APPLICABLE LAW. EXCEPT WHEN OTHERWISE STATED IN WRITING THE COPYRIGHT HOLDERS AND/OR OTHER PARTIES PROVIDE THE LIBRARY “AS IS” WITHOUT WARRANTY OF ANY KIND, EITHER EXPRESSED OR IMPLIED, INCLUDING, BUT NOT LIMITED TO, THE IMPLIED WARRANTIES OF MERCHANTABILITY AND FITNESS FOR A PARTICULAR PURPOSE. THE ENTIRE RISK AS TO THE QUALITY AND PERFORMANCE OF THE LIBRARY IS WITH YOU. SHOULD THE LIBRARY PROVE DEFECTIVE, YOU ASSUME THE COST OF ALL NECESSARY SERVICING, REPAIR OR CORRECTION.

16. IN NO EVENT UNLESS REQUIRED BY APPLICABLE LAW OR AGREED TO IN WRITING WILL ANY COPYRIGHT HOLDER, OR ANY OTHER PARTY WHO MAY MODIFY AND/OR REDISTRIBUTE THE LIBRARY AS PERMITTED ABOVE, BE LIABLE TO YOU FOR DAMAGES, INCLUDING ANY GENERAL, SPECIAL, INCIDENTAL OR CONSEQUENTIAL DAMAGES ARISING OUT OF THE USE OR INABILITY TO USE THE LIBRARY (INCLUDING BUT NOT LIMITED TO LOSS OF DATA OR DATA BEING RENDERED INACCURATE OR LOSSES SUSTAINED BY YOU OR THIRD PARTIES OR A FAILURE OF THE LIBRARY TO OPERATE WITH ANY OTHER SOFTWARE), EVEN IF SUCH HOLDER OR OTHER PARTY HAS BEEN ADVISED OF THE POSSIBILITY OF SUCH DAMAGES.

END OF TERMS AND CONDITIONS

How to Apply These Terms to Your New Libraries

If you develop a new library, and you want it to be of the greatest possible use to the public, we recommend making it free software that everyone can redistribute and change. You can do so by permitting redistribution under these terms (or, alternatively, under the terms of the ordinary General Public License).

To apply these terms, attach the following notices to the library. It is safest to attach them to the start of each source file to most effectively convey the exclusion of warranty; and each file should have at least the “copyright” line and a pointer to where the full notice is found.

<one line to give the library’s name and an idea of what it does.> Copyright (C) <year> <name of author>

This library is free software; you can redistribute it and/or modify it under the terms of the GNU Lesser General Public License as published by the Free Software Foundation; either version 2.1 of the License, or (at your option) any later version.

This library is distributed in the hope that it will be useful, but WITHOUT ANY WARRANTY; without even the implied warranty of MERCHANTABILITY or FITNESS FOR A PARTICULAR PURPOSE. See the GNU Lesser General Public License for more details.

You should have received a copy of the GNU Lesser General Public License along with this library; if not, write to the Free Software Foundation, Inc., 59 Temple Place, Suite 330, Boston, MA 02111-1307 USA

Also add information on how to contact you by electronic and paper mail.

You should also get your employer (if you work as a programmer) or your school, if any, to sign a “copyright disclaimer” for the library, if necessary. Here is a sample; alter the names:

Yoyodyne, Inc., hereby disclaims all copyright interest in the library ‘Frob’ (a library for tweaking knobs) written by James Random Hacker.

signature of Ty Coon, 1 April 1990
Ty Coon, President of Vice

That’s all there is to it!

Mozilla Public License 1.1 (MPL 1.1)

1. Definitions.

1.0.1. "Commercial Use"

means distribution or otherwise making the Covered Code available to a third party.

1.1. "Contributor"

means each entity that creates or contributes to the creation of Modifications.

1.2. "Contributor Version"

means the combination of the Original Code, prior Modifications used by a Contributor, and the Modifications made by that particular Contributor.

1.3. "Covered Code"

means the Original Code or Modifications or the combination of the Original Code and Modifications, in each case including portions thereof.

1.4. "Electronic Distribution Mechanism"

means a mechanism generally accepted in the software development community for the electronic transfer of data.

1.5. "Executable"

means Covered Code in any form other than Source Code.

1.6. "Initial Developer"

means the individual or entity identified as the Initial Developer in the Source Code notice required by Exhibit A.

1.7. "Larger Work"

means a work which combines Covered Code or portions thereof with code not governed by the terms of this License.

1.8. "License"

means this document.

1.8.1. "Licensable"

means having the right to grant, to the maximum extent possible, whether at the time of the initial grant or subsequently acquired, any and all of the rights conveyed herein.

1.9. "Modifications"

means any addition to or deletion from the substance or structure of either the Original Code or any previous Modifications. When Covered Code is released as a series of files, a Modification is:

(a) Any addition to or deletion from the contents of a file containing Original Code or previous Modifications.

(b) Any new file that contains any part of the Original Code or previous Modifications.

1.10. "Original Code"

means Source Code of computer software code which is described in the Source Code notice required by Exhibit A as Original Code, and which, at the time of its release under this License is not already Covered Code governed by this License.

1.10.1. "Patent Claims"

means any patent claim(s), now owned or hereafter acquired, including without limitation, method, process, and apparatus claims, in any patent Licensable by grantor.

1.11. "Source Code"

means the preferred form of the Covered Code for making modifications to it, including all modules it contains, plus any associated interface definition files, scripts used to control compilation and installation of an Executable, or source code differential comparisons against either the Original Code or another well known, available Covered Code of the Contributor's choice. The Source Code can be in a compressed or archival form, provided the appropriate decompression or de-archiving software is widely available for no charge.

1.12. "You" (or "Your")

means an individual or a legal entity exercising rights under, and complying with all of the terms of, this License or a future version of this License issued under Section 6.1. For legal entities, "You" includes any entity which controls, is controlled by, or is under common control with You. For purposes of this definition, "control" means (a) the power, direct or indirect, to cause the direction or management of such entity, whether by contract or otherwise, or (b) ownership of more than fifty percent (50%) of the outstanding shares or beneficial ownership of such entity.

2. Source Code License.**2.1. The Initial Developer Grant.**

The Initial Developer hereby grants You a world-wide, royalty-free, non-exclusive license, subject to third party intellectual property claims:

(a) under intellectual property rights (other than patent or trademark) Licensable by Initial Developer to use, reproduce, modify, display, perform, sublicense and distribute the Original Code (or portions thereof) with or without Modifications, and/or as part of a Larger Work; and

(b) under Patents Claims infringed by the making, using or selling of Original Code, to make, have made, use, practice, sell, and offer for sale, and/or otherwise dispose of the Original Code (or portions thereof).

(c) the licenses granted in this Section 2.1(a) and (b) are effective on the date Initial Developer first distributes Original Code under the terms of this License.

(d) Notwithstanding Section 2.1(b) above, no patent license is granted: 1) for code that You delete from the Original Code; 2) separate from the Original Code; or 3) for infringements caused by: i) the modification of the Original Code or ii) the combination of the Original Code with other software or devices.

2.2. Contributor Grant.

Subject to third party intellectual property claims, each Contributor hereby grants You a world-wide, royalty-free, non-exclusive license

(a) under intellectual property rights (other than patent or trademark) Licensable by Contributor, to use, reproduce, modify, display, perform, sublicense and distribute the Modifications created by such Contributor (or portions thereof) either on an unmodified basis, with other Modifications, as Covered Code and/or as part of a Larger Work; and

(b) under Patent Claims infringed by the making, using, or selling of Modifications made by that Contributor either alone and/or in combination with its Contributor Version (or portions of such combination), to make, use, sell, offer for sale, have made, and/or otherwise dispose of: 1) Modifications made by that Contributor (or portions thereof); and 2) the combination of Modifications made by that Contributor with its Contributor Version (or portions of such combination).

(c) the licenses granted in Sections 2.2(a) and 2.2(b) are effective on the date Contributor first makes Commercial Use of the Covered Code.

(d) Notwithstanding Section 2.2(b) above, no patent license is granted: 1) for any code that Contributor has deleted from the Contributor Version; 2) separate from the Contributor Version; 3) for infringements caused by: i) third party modifications of Contributor Version or ii) the combination of Modifications made by that Contributor with other software (except as part of the Contributor Version) or other devices; or 4) under Patent Claims infringed by Covered Code in the absence of Modifications made by that Contributor.

3. Distribution Obligations.

3.1. Application of License.

The Modifications which You create or to which You contribute are governed by the terms of this License, including without limitation Section 2.2. The Source Code version of Covered Code may be distributed only under the terms of this License or a future version of this License released under Section 6.1, and You must include a copy of this License with every copy of the Source Code You distribute. You may not offer or impose any terms on any Source Code version that alters or restricts the applicable version of this License or the recipients' rights hereunder. However, You may include an additional document offering the additional rights described in Section 3.5.

3.2. Availability of Source Code.

Any Modification which You create or to which You contribute must be made available in Source Code form under the terms of this License either on the same media as an Executable version or via an accepted Electronic Distribution Mechanism to anyone to whom you made an Executable version available; and if made available via Electronic Distribution Mechanism,

must remain available for at least twelve (12) months after the date it initially became available, or at least six (6) months after a subsequent version of that particular Modification has been made available to such recipients. You are responsible for ensuring that the Source Code version remains available even if the Electronic Distribution Mechanism is maintained by a third party.

3.3. Description of Modifications.

You must cause all Covered Code to which You contribute to contain a file documenting the changes You made to create that Covered Code and the date of any change. You must include a prominent statement that the Modification is derived, directly or indirectly, from Original Code provided by the Initial Developer and including the name of the Initial Developer in (a) the Source Code, and (b) in any notice in an Executable version or related documentation in which You describe the origin or ownership of the Covered Code.

3.4. Intellectual Property Matters

(a) Third Party Claims.

If Contributor has knowledge that a license under a third party's intellectual property rights is required to exercise the rights granted by such Contributor under Sections 2.1 or 2.2, Contributor must include a text file with the Source Code distribution titled "LEGAL" which describes the claim and the party making the claim in sufficient detail that a recipient will know whom to contact. If Contributor obtains such knowledge after the Modification is made available as described in Section 3.2, Contributor shall promptly modify the LEGAL file in all copies Contributor makes available thereafter and shall take other steps (such as notifying appropriate mailing lists or newsgroups) reasonably calculated to inform those who received the Covered Code that new knowledge has been obtained.

(b) Contributor APIs.

If Contributor's Modifications include an application programming interface and Contributor has knowledge of patent licenses which are reasonably necessary to implement that API, Contributor must also include this information in the LEGAL file.

(c) Representations.

Contributor represents that, except as disclosed pursuant to Section 3.4(a) above, Contributor believes that Contributor's Modifications are Contributor's original creation(s) and/or Contributor has sufficient rights to grant the rights conveyed by this License.

3.5. Required Notices.

You must duplicate the notice in Exhibit A in each file of the Source Code. If it is not possible to put such notice in a particular

Source Code file due to its structure, then You must include such notice in a location (such as a relevant directory) where a user would be likely to look for such a notice. If You created one or more Modification(s) You may add your name as a Contributor to the notice described in Exhibit A. You must also duplicate this License in any documentation for the Source Code where You describe recipients' rights or ownership rights relating to Covered Code. You may choose to offer, and to charge a fee for, warranty, support, indemnity or liability obligations to one or more recipients of Covered Code. However, You may do so only on Your own behalf, and not on behalf of the Initial Developer or any Contributor You must make it absolutely clear than any such warranty, support, indemnity or liability obligation is offered by You alone, and You hereby agree to indemnify the Initial Developer and every Contributor for any liability incurred by the Initial Developer or such Contributor as a result of warranty, support, indemnity or liability terms You offer.

3.6. Distribution of Executable Versions.

You may distribute Covered Code in Executable form only if the requirements of Section 3.1-3.5 have been met for that Covered Code, and if You include a notice stating that the Source Code version of the Covered Code is available under the terms of this License, including a description of how and where You have fulfilled the obligations of Section 3.2. The notice must be conspicuously included in any notice in an Executable version, related documentation or collateral in which You describe recipients' rights relating to the Covered Code. You may distribute the Executable version of Covered Code or ownership rights under a license of Your choice, which may contain terms different from this License, provided that You are in compliance with the terms of this License and that the license for the Executable version does not attempt to limit or alter the recipient's rights in the Source Code version from the rights set forth in this License. If You distribute the Executable version under a different license You must make it absolutely clear that any terms which differ from this License are offered by You alone, not by the Initial Developer or any Contributor. You hereby agree to indemnify the Initial Developer and every Contributor for any liability incurred by the Initial Developer or such Contributor as a result of any such terms You offer.

3.7. Larger Works.

You may create a Larger Work by combining Covered Code with other code not governed by the terms of this License and distribute the Larger Work as a single product. In such a case, You must make sure the requirements of this License are fulfilled for the Covered Code.

4. Inability to Comply Due to Statute or Regulation.

If it is impossible for You to comply with any of the terms of this License with respect to some or all of the Covered Code due to statute, judicial order, or regulation then You must: (a) comply with the terms of this License to the maximum extent possible; and (b) describe the limitations and the code they affect. Such description must be included in the LEGAL file described in Section 3.4 and must be included with all distributions of the Source Code. Except to the extent prohibited by statute or regulation, such description must be sufficiently detailed for a recipient of ordinary skill to be able to understand it.

5. Application of this License.

This License applies to code to which the Initial Developer has attached the notice in Exhibit A and to related Covered Code.

6. Versions of the License.

6.1. New Versions.

Netscape Communications Corporation ("Netscape") may publish revised and/or new versions of the License from time to time. Each version will be given a distinguishing version number.

6.2. Effect of New Versions.

Once Covered Code has been published under a particular version of the License, You may always continue to use it under the terms of that version. You may also choose to use such Covered Code under the terms of any subsequent version of the License published by Netscape. No one other than Netscape has the right to modify the terms applicable to Covered Code created under this License.

6.3. Derivative Works.

If You create or use a modified version of this License (which you may only do in order to apply it to code which is not already Covered Code governed by this License), You must (a) rename Your license so that the phrases "Mozilla", "MOZILLAPL", "MOZPL", "Netscape", "MPL", "NPL" or any confusingly similar phrase do not appear in your license (except to note that your license differs from this License) and (b) otherwise make it clear that Your version of the license contains terms which differ from the Mozilla Public License and Netscape Public License. (Filling in the name of the Initial Developer, Original Code or Contributor in the notice described in Exhibit A shall not of themselves be deemed to be modifications of this License.)

7. DISCLAIMER OF WARRANTY.

COVERED CODE IS PROVIDED UNDER THIS LICENSE ON AN "AS IS" BASIS, WITHOUT WARRANTY OF ANY KIND, EITHER EXPRESSED OR IMPLIED, INCLUDING, WITHOUT LIMITATION, WARRANTIES THAT THE COVERED CODE IS FREE OF DEFECTS, MERCHANTABLE, FIT FOR A PARTICULAR PURPOSE OR NON-INFRINGEMENT. THE ENTIRE RISK AS TO THE QUALITY AND PERFORMANCE OF THE COVERED CODE IS WITH YOU. SHOULD ANY COVERED CODE

PROVE DEFECTIVE IN ANY RESPECT, YOU (NOT THE INITIAL DEVELOPER OR ANY OTHER CONTRIBUTOR) ASSUME THE COST OF ANY NECESSARY SERVICING, REPAIR OR CORRECTION. THIS DISCLAIMER OF WARRANTY CONSTITUTES AN ESSENTIAL PART OF THIS LICENSE. NO USE OF ANY COVERED CODE IS AUTHORIZED HEREUNDER EXCEPT UNDER THIS DISCLAIMER.

8. TERMINATION.

8.1. This License and the rights granted hereunder will terminate automatically if You fail to comply with terms herein and fail

to cure such breach within 30 days of becoming aware of the breach. All sublicenses to the Covered Code which are properly granted shall survive any termination of this License. Provisions which, by their nature, must remain in effect beyond the termination of this License shall survive.

8.2. If You initiate litigation by asserting a patent infringement claim (excluding declaratory judgment actions) against Initial Developer or a Contributor (the Initial Developer or Contributor against whom You file such action is referred to as "Participant") alleging that:

(a) such Participant's Contributor Version directly or indirectly infringes any patent, then any and all rights granted by such Participant to You under Sections 2.1 and/or 2.2 of this License shall, upon 60 days notice from Participant terminate prospectively, unless if within 60 days after receipt of notice You either: (i) agree in writing to pay Participant a mutually agreeable reasonable royalty for Your past and future use of Modifications made by such Participant, or (ii) withdraw Your litigation claim with respect to the Contributor Version against such Participant. If within 60 days of notice, a reasonable royalty and payment arrangement are not mutually agreed upon in writing by the parties or the litigation claim is not withdrawn, the rights granted by Participant to You under Sections 2.1 and/or 2.2 automatically terminate at the expiration of the 60 day notice period specified above.

(b) any software, hardware, or device, other than such Participant's Contributor Version, directly or indirectly infringes any patent, then any rights granted to You by such Participant under Sections 2.1(b) and 2.2(b) are revoked effective as of the date You first made, used, sold, distributed, or had made, Modifications made by that Participant.

8.3. If You assert a patent infringement claim against Participant alleging that such Participant's Contributor Version directly or indirectly infringes any patent where such claim is resolved (such as by license or settlement) prior to the initiation of patent infringement litigation, then the reasonable value of the licenses granted by such Participant under Sections 2.1 or 2.2 shall be taken into account in determining the amount or value of any payment or license. 8.4. In the event of termination under Sections 8.1 or 8.2 above, all end user license agreements (excluding distributors and resellers) which have been validly granted by You or any distributor hereunder prior to termination shall survive termination.

9. LIMITATION OF LIABILITY.

UNDER NO CIRCUMSTANCES AND UNDER NO LEGAL THEORY, WHETHER TORT (INCLUDING NEGLIGENCE), CONTRACT, OR OTHERWISE, SHALL YOU, THE INITIAL DEVELOPER, ANY OTHER CONTRIBUTOR, OR ANY DISTRIBUTOR OF COVERED CODE, OR ANY SUPPLIER OF ANY OF SUCH PARTIES, BE LIABLE TO ANY PERSON FOR ANY INDIRECT, SPECIAL, INCIDENTAL, OR CONSEQUENTIAL DAMAGES OF ANY CHARACTER INCLUDING, WITHOUT LIMITATION, DAMAGES FOR LOSS OF GOODWILL, WORK STOPPAGE, COMPUTER FAILURE OR MALFUNCTION, OR ANY AND ALL OTHER COMMERCIAL DAMAGES OR LOSSES, EVEN IF SUCH PARTY SHALL HAVE BEEN INFORMED OF THE POSSIBILITY OF SUCH DAMAGES. THIS LIMITATION OF LIABILITY SHALL NOT APPLY TO LIABILITY FOR DEATH OR PERSONAL INJURY RESULTING FROM SUCH PARTY'S NEGLIGENCE TO THE EXTENT APPLICABLE LAW PROHIBITS SUCH LIMITATION. SOME JURISDICTIONS DO NOT ALLOW THE EXCLUSION OR LIMITATION OF INCIDENTAL OR CONSEQUENTIAL DAMAGES, SO THIS EXCLUSION AND LIMITATION MAY NOT APPLY TO YOU.

10. U.S. GOVERNMENT END USERS.

The Covered Code is a "commercial item," as that term is defined in 48 C.F.R. 2.101 (Oct. 1995), consisting of "commercial computer software" and "commercial computer software documentation," as such terms are used in 48 C.F.R. 12.212 (Sept. 1995). Consistent with 48 C.F.R. 12.212 and 48 C.F.R. 227.7202-1 through 227.7202-4 (June 1995), all U.S. Government End Users acquire Covered Code with only those rights set forth herein.

11. MISCELLANEOUS.

This License represents the complete agreement concerning subject matter hereof. If any provision of this License is held to be unenforceable, such provision shall be reformed only to the extent necessary to make it enforceable. This License shall be governed by California law provisions (except to the extent applicable law, if any, provides otherwise), excluding its conflict-of-law provisions. With respect to disputes in which at least one party is a citizen of, or an entity chartered or registered to do business in the United States of America, any litigation relating to this License shall be subject to the jurisdiction of the Federal Courts of the Northern District of California, with venue lying in Santa Clara County, California, with the losing party responsible for costs, including without limitation, court costs and reasonable attorneys' fees and expenses. The application of the United Nations Convention on Contracts for the International Sale of Goods is expressly excluded. Any law or regulation which provides that the language of a contract shall be construed against the drafter shall not apply to this License.

12. RESPONSIBILITY FOR CLAIMS.

As between Initial Developer and the Contributors, each party is responsible for claims and damages arising, directly or indirectly, out of its utilization of rights under this License and You agree to work with Initial Developer and Contributors to distribute such responsibility on an equitable basis. Nothing herein is intended or shall be deemed to constitute any admission of liability.

13. MULTIPLE-LICENSED CODE.

Initial Developer may designate portions of the Covered Code as Multiple-Licensed. Multiple-Licensed means that the Initial Developer permits you to utilize portions of the Covered Code under Your choice of the MPL or the alternative licenses, if any, specified by the Initial Developer in the file described in Exhibit A.

EXHIBIT A -Mozilla Public License.

“The contents of this file are subject to the Mozilla Public License Version 1.1 (the “License”); you may not use this file except in compliance with the License. You may obtain a copy of the License at <http://www.mozilla.org/MPL/>

Software distributed under the License is distributed on an “AS IS” basis, WITHOUT WARRANTY OF ANY KIND, either express or implied. See the License for the specific language governing rights and limitations under the License.

The Original Code is _____.
 The Initial Developer of the Original Code is _____.
 Portions created by _____ are Copyright (C) _____
 _____All Rights Reserved.
 Contributor(s): _____.

Alternatively, the contents of this file may be used under the terms of the _____ license (the [_____] License), in which case the provisions of [_____] License are applicable instead of those above.If you wish to allow use of your version of this file only under the terms of the [_____] License and not to allow others to use your version of this file under the MPL, indicate your decision by deleting the provisions above and replace them with the notice and other provisions required by the [_____] License. If you do not delete the provisions above, a recipient may use your version of this file under either the MPL or the [_____] License.”

[NOTE: The text of this Exhibit A may differ slightly from the text of the notices in the Source Code files of the Original Code. You should use the text of this Exhibit A rather than the text found in the Original Code Source Code for Your Modifications.]

OpenSSL License

Copyright (c) 1998-2008 The OpenSSL Project. All rights reserved.

Redistribution and use in source and binary forms, with or without modification, are permitted provided that the following conditions are met:

1. Redistributions of source code must retain the above copyright notice, this list of conditions and the following disclaimer.
2. Redistributions in binary form must reproduce the above copyright notice, this list of conditions and the following disclaimer in the documentation and/or other materials provided with the distribution.
3. All advertising materials mentioning features or use of this software must display the following acknowledgment: "This product includes software developed by the OpenSSL Project for use in the OpenSSL Toolkit. (<http://www.openssl.org/>)"
4. The names "OpenSSL Toolkit" and "OpenSSL Project" must not be used to endorse or promote products derived from this software without prior written permission. For written permission, please contact openssl-core@openssl.org.
5. Products derived from this software may not be called "OpenSSL" nor may "OpenSSL" appear in their names without prior written permission of the OpenSSL Project.
6. Redistributions of any form whatsoever must retain the following acknowledgment: "This product includes software developed by the OpenSSL Project for use in the OpenSSL Toolkit (<http://www.openssl.org/>)"

THIS SOFTWARE IS PROVIDED BY THE OpenSSL PROJECT "AS IS" AND ANY EXPRESSED OR IMPLIED WARRANTIES, INCLUDING, BUT NOT LIMITED TO, THE IMPLIED WARRANTIES OF MERCHANTABILITY AND FITNESS FOR A PARTICULAR PURPOSE ARE DISCLAIMED. IN NO EVENT SHALL THE OpenSSL PROJECT OR ITS CONTRIBUTORS BE LIABLE FOR ANY DIRECT, INDIRECT, INCIDENTAL, SPECIAL, EXEMPLARY, OR CONSEQUENTIAL DAMAGES (INCLUDING, BUT NOT LIMITED TO, PROCUREMENT OF SUBSTITUTE GOODS OR SERVICES; LOSS OF USE, DATA, OR PROFITS; OR BUSINESS INTERRUPTION) HOWEVER CAUSED AND ON ANY THEORY OF LIABILITY, WHETHER IN CONTRACT, STRICT LIABILITY, OR TORT (INCLUDING NEGLIGENCE OR OTHERWISE) ARISING IN ANY WAY OUT OF THE USE OF THIS SOFTWARE, EVEN IF ADVISED OF THE POSSIBILITY OF SUCH DAMAGE.

This product includes cryptographic software written by Eric Young (ey@cryptsoft.com).
This product includes software written by Tim Hudson (tjh@cryptsoft.com).

Original SSLeay License

Copyright (C) 1995-1998 Eric Young (ey@cryptsoft.com) All rights reserved.

This package is an SSL implementation written by Eric Young (ey@cryptsoft.com).
The implementation was written so as to conform with Netscapes SSL.

This library is free for commercial and non-commercial use as long as the following conditions are adhered to. The following conditions apply to all code found in this distribution, be it the RC4, RSA, lhash, DES, etc., code; not just the SSL code. The SSL documentation included with this distribution is covered by the same copyright terms except that the holder is Tim Hudson (tjh@cryptsoft.com).

Copyright remains Eric Young's, and as such any Copyright notices in the code are not to be removed. If this package is used in a product, Eric Young should be given attribution as the author of the parts of the library used. This can be in the form of a textual message at program startup or in documentation (online or textual) provided with the package.

Redistribution and use in source and binary forms, with or without modification, are permitted provided that the following conditions are met:

1. Redistributions of source code must retain the copyright notice, this list of conditions and the following disclaimer.
2. Redistributions in binary form must reproduce the above copyright notice, this list of conditions and the following disclaimer in the documentation and/or other materials provided with the distribution.

3. All advertising materials mentioning features or use of this software must display the following acknowledgement:
"This product includes cryptographic software written by Eric Young (eay@cryptsoft.com)"

The word 'cryptographic' can be left out if the routines from the library being used are not cryptographic related :-).

4. If you include any Windows specific code (or a derivative thereof) from the apps directory (application code) you must include an acknowledgement:

"This product includes software written by Tim Hudson (tjh@cryptsoft.com)"

THIS SOFTWARE IS PROVIDED BY ERIC YOUNG "AS IS" AND ANY EXPRESS OR IMPLIED WARRANTIES, INCLUDING, BUT NOT LIMITED TO, THE IMPLIED WARRANTIES OF MERCHANTABILITY AND FITNESS FOR A PARTICULAR PURPOSE ARE DISCLAIMED. IN NO EVENT SHALL THE AUTHOR OR CONTRIBUTORS BE LIABLE FOR ANY DIRECT, INDIRECT, INCIDENTAL, SPECIAL, EXEMPLARY, OR CONSEQUENTIAL DAMAGES (INCLUDING, BUT NOT LIMITED TO, PROCUREMENT OF SUBSTITUTE GOODS OR SERVICES; LOSS OF USE, DATA, OR PROFITS; OR BUSINESS INTERRUPTION) HOWEVER CAUSED AND ON ANY THEORY OF LIABILITY, WHETHER IN CONTRACT, STRICT LIABILITY, OR TORT (INCLUDING NEGLIGENCE OR OTHERWISE) ARISING IN ANY WAY OUT OF THE USE OF THIS SOFTWARE, EVEN IF ADVISED OF THE POSSIBILITY OF SUCH DAMAGE.

The licence and distribution terms for any publically available version or derivative of this code cannot be changed. i.e. this code cannot simply be copied and put under another distribution licence [including the GNU Public Licence.]

MIT license

- libcurl

Copyright (c) 1996 - 2010, Daniel Stenberg, <daniel@haxx.se>.

All rights reserved.

Permission to use, copy, modify, and distribute this software for any purpose with or without fee is hereby granted, provided that the above copyright notice and this permission notice appear in all copies.

THE SOFTWARE IS PROVIDED "AS IS", WITHOUT WARRANTY OF ANY KIND, EXPRESS OR IMPLIED, INCLUDING BUT NOT LIMITED TO THE WARRANTIES OF MERCHANTABILITY, FITNESS FOR A PARTICULAR PURPOSE AND NONINFRINGEMENT OF THIRD PARTY RIGHTS. IN NO EVENT SHALL THE AUTHORS OR COPYRIGHT HOLDERS BE LIABLE FOR ANY CLAIM, DAMAGES OR OTHER LIABILITY, WHETHER IN AN ACTION OF CONTRACT, TORT OR OTHERWISE, ARISING FROM, OUT OF OR IN CONNECTION WITH THE SOFTWARE OR THE USE OR OTHER DEALINGS IN THE SOFTWARE.

Except as contained in this notice, the name of a copyright holder shall not be used in advertising or otherwise to promote the sale, use or other dealings in this Software without prior written authorization of the copyright holder.

- ncurses

Copyright (c) 1998 Free Software Foundation, Inc.

Permission is hereby granted, free of charge, to any person obtaining a copy of this software and associated documentation files (the "Software"), to deal in the Software without restriction, including without limitation the rights to use, copy, modify, merge, publish, distribute, distribute with modifications, sublicense, and/or sell copies of the Software, and to permit persons to whom the Software is furnished to do so, subject to the following conditions:

The above copyright notice and this permission notice shall be included in all copies or substantial portions of the Software.

THE SOFTWARE IS PROVIDED "AS IS", WITHOUT WARRANTY OF ANY KIND, EXPRESS OR IMPLIED, INCLUDING BUT NOT LIMITED TO THE WARRANTIES OF MERCHANTABILITY, FITNESS FOR A PARTICULAR PURPOSE AND NONINFRINGEMENT. IN NO EVENT SHALL THE ABOVE COPYRIGHT HOLDERS BE LIABLE FOR ANY CLAIM, DAMAGES OR OTHER LIABILITY, WHETHER IN AN ACTION OF CONTRACT, TORT OR OTHERWISE, ARISING FROM, OUT OF OR IN CONNECTION WITH THE SOFTWARE OR THE USE OR OTHER DEALINGS IN THE SOFTWARE.

Except as contained in this notice, the name(s) of the above copyright holders shall not be used in advertising or otherwise to promote the sale, use or other dealings in this Software without prior written authorization.

Expat license

The source package was downloaded from <URL:http://expat.sourceforge.net>.

The original packager is Adam Di Carlo <aph@debian.org>.
The current maintainer is Ardo van Rangelrooij <ardo@debian.org>.

Copyright (c) 1998, 1999, 2000 Thai Open Source Software Center Ltd and Clark Cooper
Copyright (c) 2001, 2002, 2003, 2004, 2005, 2006 Expat maintainers.

Permission is hereby granted, free of charge, to any person obtaining a copy of this software and associated documentation files (the "Software"), to deal in the Software without restriction, including without limitation the rights to use, copy, modify, merge, publish, distribute, sublicense, and/or sell copies of the Software, and to permit persons to whom the Software is furnished to do so, subject to the following conditions:

The above copyright notice and this permission notice shall be included in all copies or substantial portions of the Software.

THE SOFTWARE IS PROVIDED "AS IS", WITHOUT WARRANTY OF ANY KIND, EXPRESS OR IMPLIED, INCLUDING BUT NOT LIMITED TO THE WARRANTIES OF MERCHANTABILITY, FITNESS FOR A PARTICULAR PURPOSE AND NONINFRINGEMENT. IN NO EVENT SHALL THE AUTHORS OR COPYRIGHT HOLDERS BE LIABLE FOR ANY CLAIM, DAMAGES OR OTHER LIABILITY, WHETHER IN AN ACTION OF CONTRACT, TORT OR OTHERWISE, ARISING FROM, OUT OF OR IN CONNECTION WITH THE SOFTWARE OR THE USE OR OTHER DEALINGS IN THE SOFTWARE.

The FreeType Project LICENSE

Copyright 1996-2002, 2006 by David Turner, Robert Wilhelm, and Werner Lemberg

Introduction

=====

The FreeType Project is distributed in several archive packages; some of them may contain, in addition to the FreeType font engine, various tools and contributions which rely on, or relate to, the FreeType Project.

This license applies to all files found in such packages, and which do not fall under their own explicit license. The license affects thus the FreeType font engine, the test programs, documentation and makefiles, at the very least.

This license was inspired by the BSD, Artistic, and IJG (Independent JPEG Group) licenses, which all encourage inclusion and use of free software in commercial and freeware products alike. As a consequence, its main points are that:

- We don't promise that this software works. However, we will be interested in any kind of bug reports. ('as is' distribution)

- You can use this software for whatever you want, in parts or full form, without having to pay us. ('royalty-free' usage)

- You may not pretend that you wrote this software. If you use it, or only parts of it, in a program, you must acknowledge somewhere in your documentation that you have used the FreeType code. ('credits')

We specifically permit and encourage the inclusion of this software, with or without modifications, in commercial products. We disclaim all warranties covering The FreeType Project and assume no liability related to The FreeType Project.

Finally, many people asked us for a preferred form for a credit/disclaimer to use in compliance with this license. We

thus encourage you to use the following text:

Portions of this software are copyright <year> The FreeType Project (www.freetype.org). All rights reserved.
Please replace <year> with the value from the FreeType version you actually use.

Legal Terms

0. Definitions

Throughout this license, the terms 'package', 'FreeType Project' and 'FreeType archive' refer to the set of files originally distributed by the authors (David Turner, Robert Wilhelm, and Werner Lemberg) as the 'FreeType Project', be they named as alpha, beta or final release.

'You' refers to the licensee, or person using the project, where 'using' is a generic term including compiling the project's source code as well as linking it to form a 'program' or 'executable'. This program is referred to as 'a program using the FreeType engine'.

This license applies to all files distributed in the original FreeType Project, including all source code, binaries and documentation, unless otherwise stated in the file in its original, unmodified form as distributed in the original archive. If you are unsure whether or not a particular file is covered by this license, you must contact us to verify this.

The FreeType Project is copyright (C) 1996-2000 by David Turner, Robert Wilhelm, and Werner Lemberg. All rights reserved except as specified below.

1. No Warranty

THE FREETYPE PROJECT IS PROVIDED 'AS IS' WITHOUT WARRANTY OF ANY KIND, EITHER EXPRESS OR IMPLIED, INCLUDING, BUT NOT LIMITED TO, WARRANTIES OF MERCHANTABILITY AND FITNESS FOR A PARTICULAR PURPOSE. IN NO EVENT WILL ANY OF THE AUTHORS OR COPYRIGHT HOLDERS BE LIABLE FOR ANY DAMAGES CAUSED BY THE USE OR THE INABILITY TO USE, OF THE FREETYPE PROJECT.

2. Redistribution

This license grants a worldwide, royalty-free, perpetual and irrevocable right and license to use, execute, perform, compile, display, copy, create derivative works of, distribute and sublicense the FreeType Project (in both source and object code forms) and derivative works thereof for any purpose; and to authorize others to exercise some or all of the rights granted herein, subject to the following conditions:

- Redistribution of source code must retain this license file ('FTL.TXT') unaltered; any additions, deletions or changes to the original files must be clearly indicated in accompanying documentation. The copyright notices of the unaltered, original files must be preserved in all copies of source files.
- Redistribution in binary form must provide a disclaimer that states that the software is based in part of the work of the FreeType Team, in the distribution documentation. We also encourage you to put an URL to the FreeType web page in your documentation, though this isn't mandatory.

These conditions apply to any software derived from or based on the FreeType Project, not just the unmodified files. If you use our work, you must acknowledge us. However, no fee need be paid to us.

3. Advertising

Neither the FreeType authors and contributors nor you shall use the name of the other for commercial, advertising, or promotional purposes without specific prior written permission. We suggest, but do not require, that you use one or more of the following phrases to refer to this software in your documentation or advertising materials: 'FreeType Project', 'FreeType Engine', 'FreeType library', or 'FreeType Distribution'.

As you have not signed this license, you are not required to accept it. However, as the FreeType Project is copyrighted material, only this license, or another one contracted with the authors, grants you the right to use, distribute, and modify it. Therefore, by using, distributing, or modifying the FreeType Project, you indicate that you understand and accept all the terms of this license.

4. Contacts

There are two mailing lists related to FreeType:

freetype@nongnu.org

Discusses general use and applications of FreeType, as well as future and wanted additions to the library and distribution. If you are looking for support, start in this list if you haven't found anything to help you in the documentation.

freetype-devel@nongnu.org

Discusses bugs, as well as engine internals, design issues, specific licenses, porting, etc.
Our home page can be found at <http://www.freetype.org>

JPEG license

This software is copyright (C) 1991-1998, Thomas G. Lane.
All Rights Reserved except as specified below.

Permission is hereby granted to use, copy, modify, and distribute this software (or portions thereof) for any purpose, without fee, subject to these conditions:

- (1) If any part of the source code for this software is distributed, then this README file must be included, with this copyright and no-warranty notice unaltered; and any additions, deletions, or changes to the original files must be clearly indicated in accompanying documentation.
- (2) If only executable code is distributed, then the accompanying documentation must state that "this software is based in part on the work of the Independent JPEG Group".
- (3) Permission for use of this software is granted only if the user accepts full responsibility for any undesirable consequences; the authors accept NO LIABILITY for damages of any kind.

zlib/libpng License

This product may contain open source software licensed under zlib/libpng License.

- **Libmng : Copyright © 2000-2008 Gerard Juyn (gerard@libmng.com)**
- **Libpng : Copyright (c) 1998-2008 Glenn Randers-Pehrson**
(Version 0.96 Copyright (c) 1996, 1997 Andreas Dilger)
(Version 0.88 Copyright (c) 1995, 1996 Guy Eric Schalnat, Group 42, Inc.)
- **Md5 checksum : Copyright (C) 1999, 2000, 2002 Aladdin Enterprises.**
- **Zlib : Copyright (C) 1995-2010 Jean-loup Gailly and Mark Adler**

This software is provided 'as-is', without any express or implied warranty. In no event will the authors be held liable for any damages arising from the use of this software.

Permission is granted to anyone to use this software for any purpose, including commercial applications, and to alter it and redistribute it freely, subject to the following restrictions:

1. The origin of this software must not be misrepresented; you must not claim that you wrote the original software. If you use this software in a product, an acknowledgment in the product documentation would be appreciated but is not required.
2. Altered source versions must be plainly marked as such, and must not be misrepresented as being the original software.
3. This notice may not be removed or altered from any source distribution.

Jean-loup Gailly
Mark Adler

X.net license

Copyright (c) 1995-2001 International Business Machines Corporation and others
All rights reserved.

Permission is hereby granted, free of charge, to any person obtaining a copy of this software and associated documen

tation files (the “Software”), to deal in the Software without restriction, including without limitation the rights to use, copy, modify, merge, publish, distribute, and/or sell copies of the Software, and to permit persons to whom the Software is furnished to do so, provided that the above copyright notice(s) and this permission notice appear in all copies of the Software and that both the above copyright notice(s) and this permission notice appear in supporting documentation.

THE SOFTWARE IS PROVIDED “AS IS”, WITHOUT WARRANTY OF ANY KIND, EXPRESS OR IMPLIED, INCLUDING BUT NOT LIMITED TO THE WARRANTIES OF MERCHANTABILITY, FITNESS FOR A PARTICULAR PURPOSE AND NONINFRINGEMENT OF THIRD PARTY RIGHTS. IN NO EVENT SHALL THE COPYRIGHT HOLDER OR HOLDERS INCLUDED IN THIS NOTICE BE LIABLE FOR ANY CLAIM, OR ANY SPECIAL INDIRECT OR CONSEQUENTIAL DAMAGES, OR ANY DAMAGES WHATSOEVER RESULTING FROM LOSS OF USE, DATA OR PROFITS, WHETHER IN AN ACTION OF CONTRACT, NEGLIGENCE OR OTHER TORTIOUS ACTION, ARISING OUT OF OR IN CONNECTION WITH THE USE OR PERFORMANCE OF THIS SOFTWARE.

Except as contained in this notice, the name of a copyright holder shall not be used in advertising or otherwise to promote the sale, use or other dealings in this Software without prior written authorization of the copyright holder.

BSD license

- strace

Copyright (c) 1991, 1992 Paul Kranenburg <pk@cs.few.eur.nl>
Copyright (c) 1993 Branko Lankester <branko@hacktic.nl>
Copyright (c) 1993 Ulrich Pegelow <pegelow@moorea.uni-muenster.de>
Copyright (c) 1995, 1996 Michael Elizabeth Chastain <mec@duracef.shout.net>
Copyright (c) 1993, 1994, 1995, 1996 Rick Sladkey <jrs@world.std.com>
Copyright (C) 1998-2003 Wichert Akkerman <wakkerma@deephackmode.org>
Copyright (c) 2002-2008 Roland McGrath <roland@redhat.com>
Copyright (c) 2003-2008 Dmitry V. Levin <ldv@altlinux.org>
Copyright (c) 2007-2008 Jan Kratochvil <jan.kratochvil@redhat.com>
All rights reserved.

Redistribution and use in source and binary forms, with or without modification, are permitted provided that the following conditions are met:

1. Redistributions of source code must retain the above copyright notice, this list of conditions and the following disclaimer.
2. Redistributions in binary form must reproduce the above copyright notice, this list of conditions and the following disclaimer in the documentation and/or other materials provided with the distribution.
3. Neither the names of PolarSSL or XySSL nor the names of its contributors may be used to endorse or promote products derived from this software without specific prior written permission.

THIS SOFTWARE IS PROVIDED BY THE COPYRIGHT HOLDERS AND CONTRIBUTORS “AS IS” AND ANY EXPRESS OR IMPLIED WARRANTIES, INCLUDING, BUT NOT LIMITED TO, THE IMPLIED WARRANTIES OF MERCHANTABILITY AND FITNESS FOR A PARTICULAR PURPOSE ARE DISCLAIMED. IN NO EVENT SHALL THE COPYRIGHT OWNER OR CONTRIBUTORS BE LIABLE FOR ANY DIRECT, INDIRECT, INCIDENTAL, SPECIAL, EXEMPLARY, OR CONSEQUENTIAL DAMAGES (INCLUDING, BUT NOT LIMITED TO, PROCUREMENT OF SUBSTITUTE GOODS OR SERVICES; LOSS OF USE, DATA, OR PROFITS; OR BUSINESS INTERRUPTION) HOWEVER CAUSED AND ON ANY THEORY OF LIABILITY, WHETHER IN CONTRACT, STRICT LIABILITY, OR TORT (INCLUDING NEGLIGENCE OR OTHERWISE) ARISING IN ANY WAY OUT OF THE USE OF THIS SOFTWARE, EVEN IF ADVISED OF THE POSSIBILITY OF SUCH DAMAGE.

- xyssl

Copyright (C) 2006-2008 Christophe Devine
Copyright (C) 2009 Paul Bakker <polarssl_maintainer at polarssl dot org>
All rights reserved.

Redistribution and use in source and binary forms, with or without modification, are permitted provided that the following conditions are met:

1. Redistributions of source code must retain the above copyright notice, this list of conditions and the following dis

claimer.

2. Redistributions in binary form must reproduce the above copyright notice, this list of conditions and the following disclaimer in the documentation and/or other materials provided with the distribution.

3. Neither the names of PolarSSL or XySSL nor the names of its contributors may be used to endorse or promote products derived from this software without specific prior written permission.

THIS SOFTWARE IS PROVIDED BY THE COPYRIGHT HOLDERS AND CONTRIBUTORS "AS IS" AND ANY EXPRESS OR IMPLIED WARRANTIES, INCLUDING, BUT NOT LIMITED TO, THE IMPLIED WARRANTIES OF MERCHANTABILITY AND FITNESS FOR A PARTICULAR PURPOSE ARE DISCLAIMED. IN NO EVENT SHALL THE COPYRIGHT OWNER OR CONTRIBUTORS BE LIABLE FOR ANY DIRECT, INDIRECT, INCIDENTAL, SPECIAL, EXEMPLARY, OR CONSEQUENTIAL DAMAGES (INCLUDING, BUT NOT LIMITED TO, PROCUREMENT OF SUBSTITUTE GOODS OR SERVICES; LOSS OF USE, DATA, OR PROFITS; OR BUSINESS INTERRUPTION) HOWEVER CAUSED AND ON ANY THEORY OF LIABILITY, WHETHER IN CONTRACT, STRICT LIABILITY, OR TORT (INCLUDING NEGLIGENCE OR OTHERWISE) ARISING IN ANY WAY OUT OF THE USE OF THIS SOFTWARE, EVEN IF ADVISED OF THE POSSIBILITY OF SUCH DAMAGE.

RSA Data Security license

Copyright (C) 1991-2, RSA Data Security, Inc. Created 1991. All rights reserved.

License to copy and use this software is granted provided that it is identified as the "RSA Data Security, Inc. MD5 Message-Digest Algorithm" in all material mentioning or referencing this software or this function.

License is also granted to make and use derivative works provided that such works are identified as "derived from the RSA Data Security, Inc. MD5 Message-Digest Algorithm" in all material mentioning or referencing the derived work.

RSA Data Security, Inc. makes no representations concerning either the merchantability of this software or the suitability of this software for any particular purpose. It is provided "as is" without express or implied warranty of any kind. These notices must be retained in any copies of any part of this documentation and/or software.



The model and serial numbers of the TV is located on the back of the TV
Record it below should you ever need service.

MODEL _____

SERIAL _____