



OWNER'S MANUAL

Mini Hi-Fi System

Please read this manual carefully before operating your set and retain it for future reference.

CM8520 (CM8520, CMS8520F/S/W)



MFL67412332

Safety Information



CAUTION: TO REDUCE THE RISK OF ELECTRIC SHOCK DO NOT REMOVE COVER (OR BACK) NO USER-SERVICEABLE PARTS INSIDE REFER SERVICING TO QUALIFIED SERVICE PERSONNEL.



This lightning flash with arrowhead symbol within an equilateral triangle is intended to alert the user to the presence of uninsulated dangerous voltage within the product's enclosure that may be of sufficient magnitude to constitute a risk of electric shock to persons.



The exclamation point within an equilateral triangle is intended to alert the user to the presence of important operating and maintenance (servicing) instructions in the literature accompanying the product.

WARNING: TO PREVENT FIRE OR ELECTRIC SHOCK HAZARD, DO NOT EXPOSE THIS PRODUCT TO RAIN OR MOISTURE.

WARNING: Do not install this equipment in a confined space such as a book case or similar unit.

CAUTION: Do not block any ventilation openings. Install in accordance with the manufacturer's instructions.

Slots and openings in the cabinet are provided for ventilation and to ensure reliable operation of the product and to protect it from over heating. The openings shall be never be blocked by placing the product on a bed, sofa, rug or other similar surface. This product shall not be placed in a built-in installation such as a bookcase or rack unless proper ventilation is provided or the manufacturer's instruction has been adhered to.



CAUTION: This product employs a Laser System. To ensure proper use of this product, please read this owner's manual carefully and retain it for future reference. Shall the unit require maintenance, contact an authorized service centre. Use of controls, adjustments or the performance of procedures other than those specified herein may result in hazardous radiation exposure. To prevent direct exposure to laser beam, do not try to open the enclosure.

CAUTION concerning the Power Cord

Most appliances recommend they be placed upon a dedicated circuit;

That is, a single outlet circuit which powers only that appliance and has no additional outlets or branch circuits. Check the specification page of this owner's manual to be certain. Do not overload wall outlets. Overloaded wall outlets, loose or damaged wall outlets, extension cords, frayed power cords, or damaged or cracked wire insulation are dangerous. Any of these conditions could result in electric shock or fire. Periodically examine the cord of your appliance, and if its appearance indicates damage or deterioration, unplug it, discontinue use of the appliance, and have the cord replaced with an exact replacement part by an authorized service center. Protect the power cord from physical or mechanical abuse, such as being twisted, kinked, pinched, closed in a door, or walked upon. Pay particular attention to plugs, wall outlets, and the point where the cord exits the appliance. To disconnect power from the mains, pull out the mains cord plug. When installing the product, ensure that the plug is easily accessible.

This device is equipped with a portable battery or accumulator.

Safety way to remove the battery or the battery from the equipment: Remove the old battery or battery pack, follow the steps in reverse order than the assembly. To prevent contamination of the environment and bring on possible threat to human and animal health, the old battery or the battery put it in the appropriate container at designated collection points. Do not dispose of batteries or battery together with other waste. It is recommended that you use local, free reimbursement systems batteries and accumulators. The battery shall not be exposed to excessive heat such as sunshine, fire or the like.

CAUTION: The apparatus shall not be exposed to water (dripping or splashing) and no objects filled with liquids, such as vases, shall be placed on the apparatus.

You have to set the disc format option to [Mastered] in order to make the discs compatible with the LG players when formatting rewritable discs. When setting the option to Live File System, you cannot use it on LG players.

(Mastered/Live File System : Disc format system for Windows Vista)

Table of Contents

1 Getting Started

- 2 Safety Information
- 6 Unique Features
- 6 Accesories
- 6 Playable file Requirement
 - 6 – MP3/WMA music file requirement
 - 6 – Compatible USB Devices
 - 6 – USB device requirement
- 7 Remote control
- 8 Front panel
- 10 Rear panel

2 Connecting

- 11 Connecting to speakers
 - 11 – Before connecting
 - 12 – Attaching the speakers to the unit
- 13 Optional Equipment Connection
 - 13 – AUX IN Connection
 - 13 – PORT. IN Connection
 - 14 – USB Connection
 - 14 – Antenna Connection

3 Operating

- 15 Basic Operations
 - 15 – CD/USB Operations
 - 16 – Selecting a folder and an MP3/WMA file
 - 16 – Deleting an MP3/WMA file
- 17 Other Operations
 - 17 – Programmed Playback
 - 17 – Turn off the sound temporarily
 - 17 – AUTO DJ playback
 - 18 – Listening to music with latin beat
 - 18 – Displaying file information (ID3 TAG)
 - 18 – DEMO
 - 18 – Using Microphone
- 19 Radio Operations
 - 19 – Listening to the radio
 - 19 – Presetting the Radio Stations
 - 19 – Deleting all the saved stations
 - 19 – Improving poor FM reception
- 20 Sound adjustment
 - 20 – Setting the surround mode
 - 20 – Setting the USER EQ
- 21 Setting the Clock
 - 21 – Using your player as an alarm clock
 - 22 – Sleep Timer Setting
 - 22 – Dimmer
- 22 Advanced Operations
 - 22 – Listening to music from your portable player or external device
 - 22 – Changing the lighting effect
 - 22 – Woofer ON/OFF
 - 23 – Recording to USB
 - 24 – Dubbing USB to USB

4 Troubleshooting

- 25 Troubleshooting
- 25 – General

5 Appendix

- 26 Trademarks and Licenses
- 27 General specifications
- 28 Speaker specifications
- 29 Maintenance
- 29 – Notes on Discs
- 29 – Handling the Unit

1

2

3

4

5

Unique Features

Portable In

Listens to music from your portable device. (MP3, Notebook, etc)

USB Direct Recording

Records music to your USB device.

Latin beat box

Listens to music with locally special beat box.

Beat lighting

Listens to music with special lighting effect.

Accessories

Please check and identify the supplied accessories.

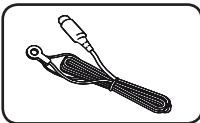

FM Antenna (1)

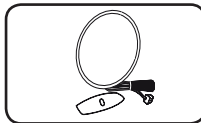

AM Antenna (1)

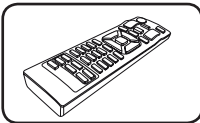

Remote Control (1)

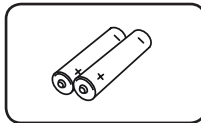

Batteries (2)

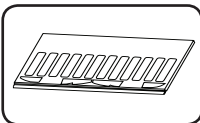

Stacking board (2)

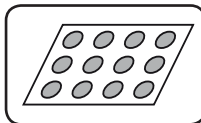

Non-skid pads (1)

Playable file Requirement

MP3/WMA music file requirement

MP3/WMA file compatibility with this unit is limited as follows.

- Sampling frequency : within 32 to 48 kHz (MP3), within 32 to 48 kHz (WMA)
- Bit rate : within 32 to 320 kbps (MP3), 40 to 192 kbps (WMA)
- Maximum files : Under 999
- File extensions : ".mp3"/".wma"
- CD-ROM file format : ISO 9660/ JOLIET
- We recommend that you use Easy-CD Creator, which creates an ISO 9660 file system.

Compatible USB Devices

- MP3 Player : Flash type MP3 player.
- USB Flash Drive : Devices that support USB2.0 or USB1.1.
- The USB function of this unit does not support all USB devices.

USB device requirement

- Devices which require additional program installation when you have connected it to a computer, are not supported.
- Do not extract the USB device while in operation.
- For a large capacity USB, it may take longer than a few minute to be searched.
- To prevent data loss, back up all data.
- If you use a USB extension cable or USB hub, the USB device is not recognized.
- Using NTFS file system is not supported. (Only FAT(16/ 32) file system is supported.)
- This unit is not supported when the total number of files is 1 000 or more.
- External HDD, Card readers, Locked devices, or hard type USB devices are not supported.
- USB port of the unit cannot be connected to PC. The unit cannot be used as a storage device.

Remote control

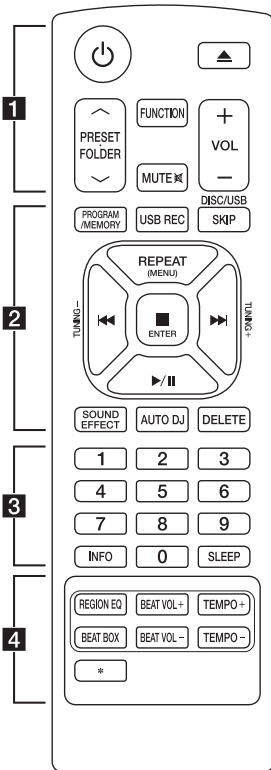

Battery Installation

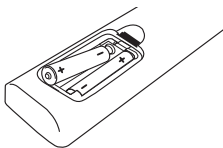

Remove the battery cover on the rear of the Remote Control, and insert two (size AAA) batteries with \oplus and \ominus matched correctly.

..... **1**

⏻ (POWER) : Switches the unit ON or OFF.

⏮ (OPEN/CLOSE) : Opens and closes the disc tray.

PRESET-FOLDER \wedge /V :

- Searches for a folder of MP3/WMA files. When a CD/USB containing MP3/WMA files in several folders is being played, press **PRESET-FOLDER \wedge /V** to select the folder you want to play.

- Chooses a preset number for a radio station.

FUNCTION : Selects the function and input source.

MUTE M : Mutes the sound.

VOL +/- : Adjusts speaker volume.

..... **2**

PROGRAM/MEMORY :

- Stores radio stations.

- Creates a playlist you want to listen to.

USB REC : USB direct recording.

DISC/USB SKIP : Chooses a desired CD or USB.

REPEAT (MENU) : Listens to your tracks/files repeatedly or randomly.

TUNING-/+ : Selects the radio stations.

⏮/⏭ (Skip/Search) :

- Skips Fast backward or Forward.

- Searches for a section within a track/file.

■ ENTER :

- Stops playback or recording.

- Cancels DELETE function.

▶/⏸ (Play/Pause) :

- Starts or pauses playback.

- Selects Stereo/Mono.

SOUND EFFECT : Chooses sound impressions.

AUTO DJ : Selects the AUTO DJ mode. (For more information refer to the page 17)

DELETE : Deletes MP3/WMA files. (USB only)

..... **3**

0 to 9 numerical buttons : Selects numbered tracks, files, or preset number.

INFO : See information about your music. MP3 files often come with ID3 tags. The tag gives the Title, Artist, Album or Time information.

SLEEP : Sets the system to turn off automatically at a specified time. (Dimmer : The display window will be darkened by half)

..... **4**

REGION EQ : Chooses region equalizer.

BEAT BOX : Turns beat box on or off.

BEAT VOL +/- : Adjusts beat box volume.

TEMPO +/- : Changes beat box's tempo.

***** : The button is not available for any function.

Front panel

1

Getting Started

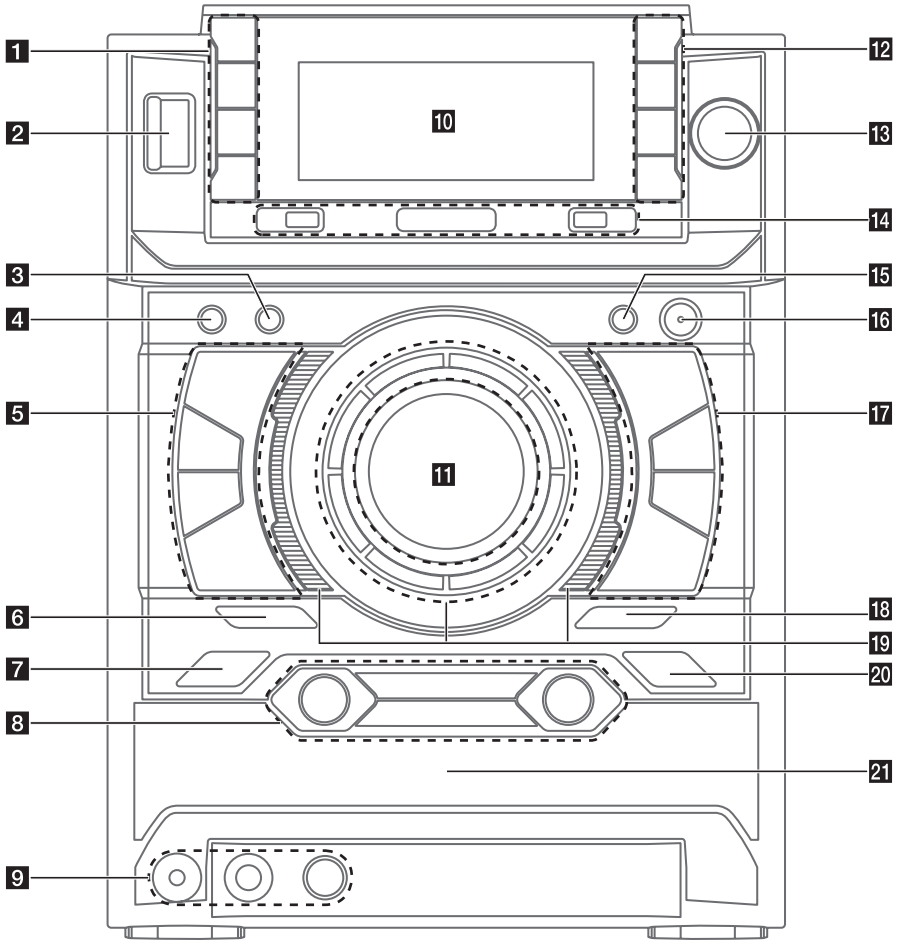

1 TIMER

With the TIMER function you can turn CD, USB play and TUNER reception on or off at a desired time.

CLOCK

For setting the clock and checking the time.

SET

Confirms the setting.



Remote control sensor

2 (Power)**3 DISC/USB SKIP**

Chooses a desired CD or USB.

4 LIGHTING EFFECT

Changes lighting effects.

5

Stops playback or cancels DELETE function.

CD

Selects the CD function.

AUX/PORT. IN

Selects the AUX or PORT. IN function.



Prev./Scan

6 BASS BLAST

Selects the BASS BLAST or BYPASS sound directly.

7 LATIN EQ

Chooses locally special equalizer.

8 BEAT VOL./SELECT

- Adjusts beat box volume level by rotating the button.
- Chooses latin beat box.

AUTO DJ

Selects the AUTO DJ mode. (For more information refer to the page 17)

BEAT BOX

Turns beat box on or off.

BEAT TEMPO./AUTO BPM

- Changes beat box tempo by rotating the button.
- Selects the AUTO BPM of beat box by pressing the button.

9 PORT. IN jack

MIC jack

MIC VOL.

10 Display window**11** Volume knob
Adjusts speaker volume.**12 ENTER**

- Selects a folder when searching a file.
- Selects the BASS, MIDDLE, and TREBLE when setting USER EQ.

FOLDER

Moves to folder and file selection mode.

DELETE

Deletes MP3/WMA files. (USB only)

USER EQ

Controls sound register.

13 FILE SEARCH

Moves to the another file/track.

14 USB 1/2 Port

You can play or record sound files by connecting the USB device.

USB REC

Recording to USB.

15 DEMO

Shows demo.

16 WOOFER ON/OFF**17 >|| ST./MONO**

Starts or pauses playback.
Selects Stereo/Mono.

USB

Selects the USB function.

TUNER

Selects the TUNER function.



Next/Scan

18 (OPEN/CLOSE)**19** Backlightings**20 SOUND EQ**

Chooses sound impressions.

21 Disc tray

1

Getting Started

Rear panel

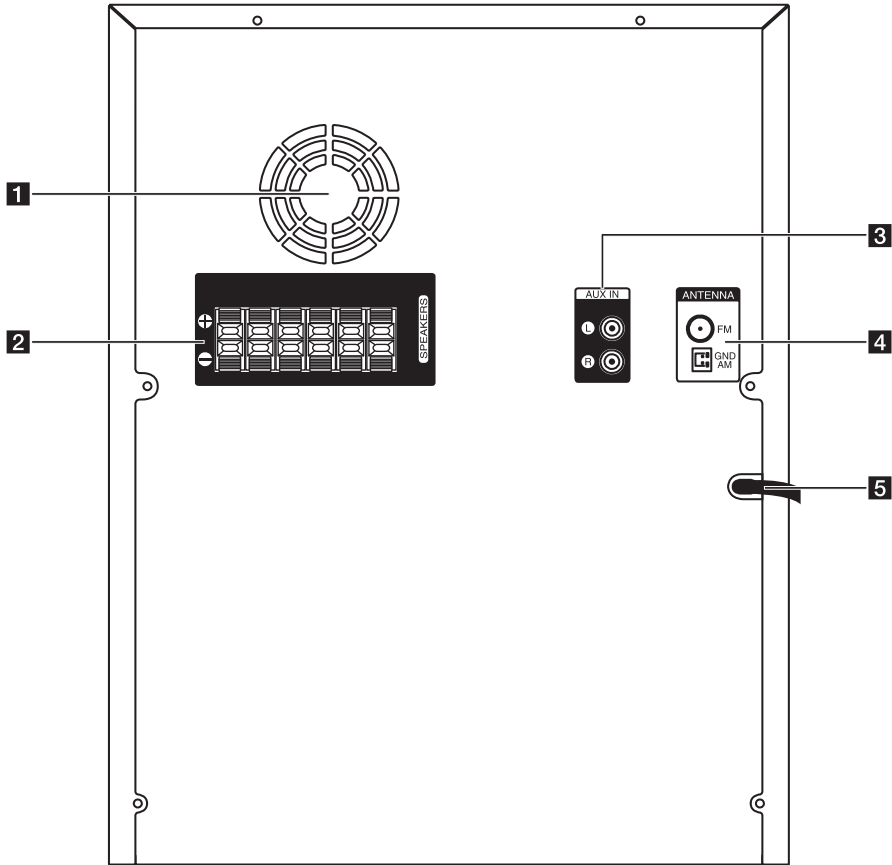

- 1** Cooling fan
- 2** **SPEAKERS** terminal
- 3** **AUX IN** connectors (L/R)
- 4** **ANTENNA** (FM, AM)
- 5** Power cord

Connecting to speakers

Before connecting

You have to position the unit and the speakers before connecting the speakers. Note that the illustrations below are differ from the actual unit. The following illustration shows an example of the positioning which is the left side of the main unit.

Positioning the speakers

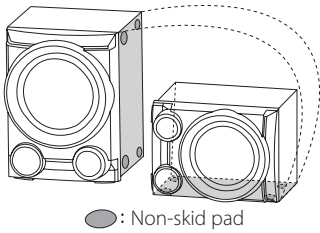

1. Attach the non-skid pads to the right side of subwoofer.
2. Lay the subwoofer down as the illustration above.

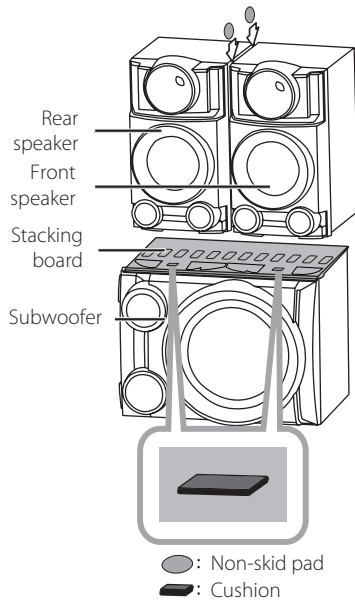

3. Put the stacking board on the subwoofer.
4. Place the front and the rear speakers on the stacking board firmly.
5. Attach the non-skid pads between the front and the rear speakers for preventing scratches.

! Caution

Do not take the cushions off the stacking board. Because the cushion is for preventing vibration from subwoofer.

Positioning the main unit and the speakers

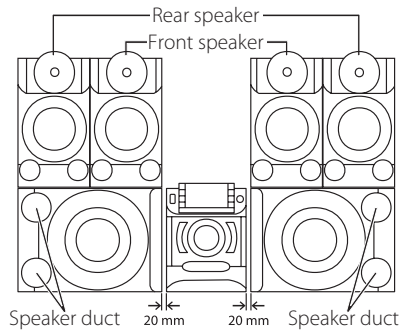

- The speaker ducts of subwoofer have to be faced opposite the main unit. Otherwise it may result in a malfunction of the main unit.
- The subwoofer have to be placed at a distance of about 20 mm from the main unit.

Attaching the speakers to the unit

To connect the cable to the unit, press each plastic finger pad to open the connection terminals on the unit. Insert the wire and release the finger pad.

Connect the black stripe of each wire to the terminals marked - (minus) and the other end to the terminals marked + (plus).

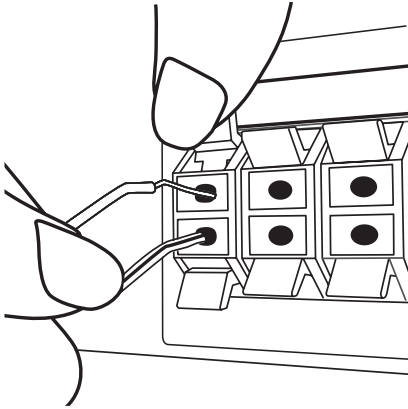

Color	Speaker
Grey	Rear R
Blue	Rear L
Orange	Sub woofer 1
Orange	Sub woofer 2
Red	Front R
White	Front L

⚠ Caution

- Be careful to make sure children not to put their hands or any objects into the *speaker duct.
*Speaker duct: A hole for plentiful bass sound on speaker cabinet (enclosure).
- The speakers contain magnet parts, so color irregularity may occur on the TV screen or PC monitor screen. Please use the speakers far away from either TV screen or PC monitor.
- Make sure to install the speaker with other people in order to prevent it from falling and causing injuries to the installer.

Optional Equipment Connection

AUX IN Connection

Connect an output of auxiliary device(Camcorder, TV, Player, etc) to the AUX IN (L/R) connector.

If your device has only one output for audio(mono), connect it to the left (white) audio jack on the unit.

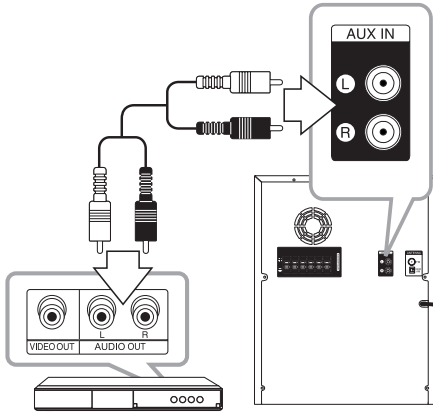

PORT. IN Connection

Connect an output (earphone or line out) of portable device (MP3 or PMP etc) to the PORT. IN connector.

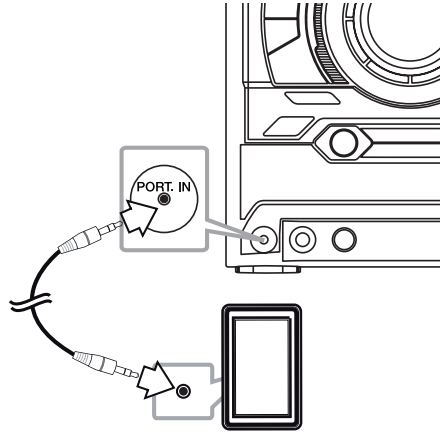

2

Connecting

USB Connection

Connect the USB port of USB Memory (or MP3 player, etc.) to the USB port on the front of the unit.

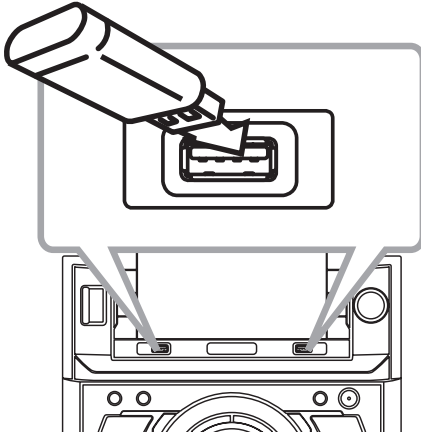

! Note

Removing the USB Device from the unit

1. Choose a different function/mode or press **ENTER** on the remote control or **ENTER** on the unit twice in a row.
2. Remove the USB device from the unit.

Antenna Connection

Connect the supplied FM/AM antenna for listening to the radio.

Connect the AM loop antenna to the AM antenna connector.

Connect the FM wire antenna to the FM antenna connector.

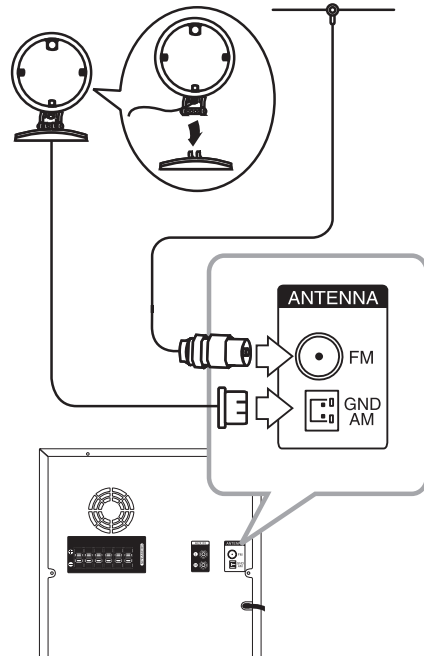

! Note

- To prevent noise pickup, keep the AM Loop antenna away from the unit and other components.
- Be sure to fully extend the FM wire antenna. After connecting the FM wire antenna, keep it horizontal.

Basic Operations

CD/USB Operations

1. Insert the disc by pressing ▲(OPEN/CLOSE) or connect the USB device to the USB port.
2. Select the CD or USB function by pressing **CD** or **USB** on the unit or **FUNCTION** on the remote control.
3. Select the desired CD/USB by pressing **DISC/USB SKIP**.

To	Do this
Stop	Press ■ ENTER on the remote control or □ on the unit.
Playback	Press ▶/ on the remote control or > ST./MONO on the unit.
Pause	Press ▶/ on the remote control or > ST./MONO on the unit during playback.
Searching for a section within a track/file	Press ◀◀/▶▶ on the remote control or ◀◀/▶▶ on the unit during playback and release it at the point you want to listen to.
Selecting a track/file directly	Press 0 to 9 numerical buttons on the remote control to go to the desired file or track directly.
Skipping to the next/previous track/file	During playback, (1) By using ◀◀/▶▶ buttons : Press ◀◀/▶▶ to go to the next track/file or to return to the beginning of the current track/file. Press ◀◀ twice briefly to step back to the previous track/file. (2) By using FILE SEARCH knob : Rotate FILE SEARCH on the unit and Press ▶/ to play the track/file.
Playing repeatedly or randomly	Press REPEAT(MENU) on the remote control repeatedly. Refer to the note for details about the display change.

Note

- The display changes in the following order.

USB	MP3/WMA CD	Audio CD
REPEAT TRK	REPEAT TRK	REPEAT TRK
REPEAT *DIR	REPEAT DIR	-
-	REPEAT CD	REPEAT CD
REPEAT ALL	REPEAT ALL	REPEAT ALL
RANDOM	RANDOM	RANDOM
OFF	OFF	OFF

*DIR : Directory

- press **DISC/USB SKIP** to rotate the disc tray.
- The next file name is displayed every 30 seconds. (Except RANDOM play, AUTO DJ RANDOM play, the last file of playlist, etc.)
- If you leave the disc tray open for 5 minutes, it will close automatically.

Selecting a folder and an MP3/WMA file

On the unit

1. Press **FOLDER** and rotate **FILE SEARCH** until a desired folder appears.
2. Press **ENTER** and Rotate **FILE SEARCH** until a desired file appears. Press **>|| ST./MONO** to play it.

On the remote control

1. Press **PRESET-FOLDER ^/V** repeatedly until a desired folder appears.
2. Press **▶/||** to play it. The first file of folder will play.

Deleting an MP3/WMA file

You can delete file, folder or format by pressing **DELETE**. This function is supported only in stop status. (USB only)

1. -Select the file you want to delete and press **DELETE**.

-Select the folder you want to delete by pressing **FOLDER** and rotating **FILE SEARCH** and press **DELETE**.

-Press and hold **DELETE** to format the USB device.

Or

Press **DELETE** repeatedly during selecting the MP3/WMA file.

The display changes in the following order.

- DEL FILE? : Deletes file
- DEL FOLDER : Deletes folder
- FORMAT? : Formats USB

2. To delete file/folder or format, press **▶/||** on the remote control or press **>|| ST./MONO** on the unit.
3. If you want to exit the current mode, press **■ ENTER** on the remote control or press **□** on the unit.

Caution

- Do not extract the USB device during operation. (play, delete, etc.)
- Regular back up is recommended to prevent data loss.
- The delete function may not be supported according to the USB status. (lock, etc.)

Other Operations

Programmed Playback

The program function enables you to store your favorite files from any disc or USB device.

A program can contain 20 tracks/files.

1. Insert a CD or a USB and wait for it to be ordered.
2. Press **PROGRAM/MEMORY** on the remote control in stop status.
3. Press **◀◀/▶▶** on the remote control or **◀◀/▶▶** on the unit to select a track/file.
4. Press **PROGRAM/MEMORY** again to save and select a next track/file.
5. Press **▶/||** to play the programmed music tracks/files.
6. To clear your selection, press **■ ENTER** twice.

! Note

The programs are also cleared when the disc or USB device is removed, the unit is powered off or the function is switched to others.

Turn off the sound temporarily

Press **MUTE**  to mute your unit.

You can mute your unit, for example, to answer the telephone, the mute icon "X||" is blinked in the display window.



AUTO DJ playback

Auto DJ blends the end of one song into the beginning of another for seamless playback. It equalizes volume across tracks/files for uninterrupted playback.

Press **AUTO DJ** on the remote control or unit repeatedly, the display changes as follows. RANDOM (AUTO DJ RANDOM) -> REPEAT ALL (AUTO DJ SEQUENTIAL) -> (AUTO DJ OFF)

Mode	Display Window	Description
OFF	- (AUTO DJ OFF)	-
RANDOM	RANDOM (AUTO DJ RANDOM)	The music is played randomly on this mode.
REPEAT	REPEAT ALL (AUTO DJ SEQUENTIAL)	The music is played repeatedly on this mode.

! Note

- Searching for a section within a track/file or playing repeatedly or randomly is not supported on the AUTO DJ mode.
- During AUTO DJ mode, pressing **PRESET FOLDER** /**▼** on the remote control or **FOLDER/FILE SEARCH** on the unit is not available.
- If you move to other functions or stop the music using  on the unit (or **■ ENTER** on the remote control) on AUTO DJ mode, AUTO DJ function will be disable.
- AUTO DJ function is not supported in the music file whose length is less than 60 seconds.
- During recording, AUTO DJ function is not available.
- If you change a disc while the AUTO DJ function is activated, the function is deactivated.

Listening to music with latin beat

You can listen to music with latin beat on beat box mode by pressing **BEAT BOX**. (CD/USB/AUX/PORTABLE)

You can select various beat box mode. Press **BEAT VOL./SELECT** repeatedly, then beat sound will be locally optimized as follows.
(REGUETON/MERENGUE/SMABA/SALSA/FORRO/FUNK/SERTANEJO/CUMBIA/ELECTRONIC/HIPHOP)

You can adjust the volume level by rotating **BEAT VOL./SELECT**.

On Display	Description
BEAT BOX AUTO BPM	You can enjoy the sound with auto beat box sound by pressing BEAT TEMPO./AUTO BPM during playback.
BEAT BOX MANUAL BPM	You can change beat sound tempo by rotating BEAT TEMPO./AUTO BPM in beat box mode.
BEAT BOX OFF	You can enjoy original sound by pressing BEAT BOX in beat box mode.

! Note

- If you change beat sound tempo in AUTO BPM mode, it will be changed to MANUAL BPM mode automatically.
- According to the original sound, LATIN BEAT may not be outputted in AUTO BPM mode.

Displaying file information (ID3 TAG)

While playing an MP3 file containing file information, you can display the information by pressing **INFO**.

DEMO

In the power off state, it demonstrates the function on display window with a demo sound and a display by pressing **DEMO**.

To cancel the DEMO, press it again.

! Note

- While DEMO, this unit will keep DEMO status even if you unplug the power cord connection.
- You can enjoy other functions during the DEMO. Then the DEMO will pause to temporary.
 - Without input key in 10 sec, the DEMO will play back automatically.

Using Microphone

1. Connect your microphone to the MIC jack.
2. Play the music you want.
3. Sing along with the accompaniment. Adjust the microphone volume by rotating **MIC VOL.** clockwise or counterclockwise on the unit.

! Note

- When not using the microphone, set the **MIC VOL.** to minimum or turn off the MIC and remove the microphone from the MIC jack.
- If the microphone is set too near the speaker, a howling sound may be produced. In this case, move the microphone away from the speaker or decrease the sound level by using the **MIC VOL.**
- If sound through the microphone is extremely loud, it may be distorted. In this case, rotate **MIC VOL.** to minimum.

Radio Operations

Be sure that both FM and AM aerials are connected. (Refer to the page 14)

Listening to the radio

1. Press **TUNER** on the unit or **FUNCTION** on the remote control until FM or AM appears in the display window.
The last received station is tuned in.
2. Press and hold **TUNING-/+** for about two seconds until the frequency indication starts to change, then release. Scanning stops when the unit tunes in a station.
Or
Press **TUNING-/+** repeatedly.
3. Adjust the volume by rotating volume knob on the unit or by pressing **VOL +/-** on the remote control repeatedly.

Presetting the Radio Stations

You can preset 50 stations for FM and AM.

Before tuning, make sure to turn down the volume.

1. Press **TUNER** on the unit or **FUNCTION** on the remote control until FM or AM appears in the display window.
2. Press **TUNING-/+** on the remote control or **|<</>>|** on the unit to select a desired frequency.
3. Press **PROGRAM/MEMORY**. A preset number will blink in the display window.
4. Press **PRESET FOLDER \wedge/\vee** to select the preset number you want.
5. Press **PROGRAM/MEMORY**. The station is stored.
6. Repeat steps 2 to 5 to store other stations.
7. To listen a preset station, press **PRESET FOLDER \wedge/\vee** or **0** to **9** numerical buttons.

Deleting all the saved stations

1. Press and hold **PROGRAM/MEMORY** for two seconds. "ERASE ALL" will flash up on the unit display.
2. Press **PROGRAM/MEMORY** to erase all saved radio stations.

Improving poor FM reception

Press **>|| ST./MONO** on the unit or **▶/||** on the remote control. This will change the tuner from stereo to mono and usually improve the reception.

Sound adjustment

Setting the surround mode

This system has a number of pre-set surround sound fields. You can select a desired sound mode by using **SOUND EQ** on the unit or **SOUND EFFECT** on the remote control.

The displayed items for the Equalizer may be different depending on sound sources and effects.

On Display	Description
NATURAL	You can enjoy comfortable and natural sound.
Local Specialization equalizer	Regionally optimized sound effect. (FORRO/FUNK/SERTANEJO/DANGDUT/ARABIC/PERSIAN/INDIA/REGUETON/MERENGUE/SALSA/SAMBA/CUMBIA/AFRO HIP HOP)
AUTO EQ	Realizes the sound equalizer that is the most similar to the genre of which is included in the MP3 ID3 tag of song files.
POP CLASSIC JAZZ ROCK	This program lends an enthusiastic atmosphere to the sound, giving you the feeling you are at an actual rock pop, jazz or classic concert.
MP3 - OPT	This function is optimized for compressible MP3 file. It improves the treble sound.
BASS BLAST	Reinforces the treble, bass and surround sound effect.
LOUDNESS	Improves the bass and treble sound.
BYPASS	You can enjoy the sound without equalizer effect.

Note

- On some speakers, sound may not be heard or heard in low sound depending on the sound mode.
- Maybe you need to reset the surround mode, after switching the input, sometimes even after the sound track/file changed.
- By pressing **BASS BLAST** on the unit you can directly select the **BYPASS** or **BASS BLAST** sound.

Setting the USER EQ

You can listen to music with the desired sound effect by adjusting the BASS, MIDDLE and TREBLE.

1. Press **USER EQ**. "USER EQ" is displayed.
2. Press **SET** to enter USER EQ mode.
3. Select the BASS, MIDDLE or TREBLE sound effect you want by pressing **ENTER**.
4. Press **◀/▶** or rotate **FILE SEARCH** to adjust the sound level you want.
5. To finish the setting, press **SET**.

Setting the Clock

1. Turn the unit on.
2. Press **CLOCK** for at least 2 seconds.
3. Choose time mode by pressing **|<</>>|**.
- AM 12:00 (for an AM and PM display) or
0:00 (for a 24 hour display)
4. Press **SET** to confirm your selection.
5. Select the hours by pressing **|<</>>|**.
6. Press **SET**.
7. Select the minutes by pressing **|<</>>|**.
8. Press **SET**.

Using your player as an alarm clock

1. Turn the unit on.
2. Press **TIMER**. Each of functions flashes.
3. Press **SET** when the function you want to be woken by is showing.
4. "ON TIME" will be displayed. Press **|<</>>|** to change the hours and minutes and press **SET** to save.
5. The "OFF TIME" will be displayed. Press **|<</>>|** to change the hours and minutes and press **SET** to save.
6. Press **|<</>>|** to change the volume and press **SET** to save. The clock icon "🕒" shows that the alarm is set.
7. Press **TIMER** button 2 times. You can check the setting status.

! Note

- If you set the clock time, you can check the time by pressing **CLOCK** even when the player is turned off.
- If you set the clock time and alarm, you can check the alarm icon "🕒" by pressing **CLOCK** even when the player is turned off.
- If you set the clock time and alarm, you can check the alarm icon "🕒" and setting information by pressing **TIMER** even when the unit is turned off.

Sleep Timer Setting

Press **SLEEP** on the remote control repeatedly to select delay time between 10 and 180 minutes. After the delay time, the unit will be turned off.

To cancel the sleep function, press **SLEEP** on the remote control repeatedly until "SLEEP 10" appears, and then press **SLEEP** on the remote control once again while "SLEEP 10" is displayed.

! Note

- You can check the remaining time before the unit is turned off.
- Press **SLEEP**. The remaining time appears in the display window.

3

Operating

Dimmer

Press **SLEEP** once. The display window will be darkened by half. To cancel it, press **SLEEP** repeatedly until dim off.

Advanced Operations

Listening to music from your portable player or external device

The unit can be used to play the music from many types of portable player or external device. (Refer to the page 13)

1. Connect the portable player to the PORT. IN connector of the unit.

Or

Connect the external device to the AUX IN connector of the unit.

2. Turn the power on by pressing **⏻/I**.
3. Select the PORTABLE or AUX function by pressing **FUNCTION** on the remote control or **AUX/PORT. IN** on the unit.
4. Turn the portable player or external device and start it playing.

Changing the lighting effect

You can change the unit's lighting effects by pressing **LIGHTING EFFECT** on the unit in 5 types. (Forward Level Mode -> Peak Level Mode -> Center Level Mode -> Reverse Level Mode -> Shower Level Mode)

Woofers ON/OFF

You can power on or off the woofer by pressing **WOOFER ON/OFF** on the unit.

! Note

Woofer sound is not outputted in AM function. And **WOOFER ON/OFF** button's light is turned off.

Recording to USB

You can record a various sound source to USB.
(CD, USB, AUX, PORTABLE, FM, AM)

1. Connect the USB device to the unit.
2. Select a function in which you want to record by using **CD, USB, TUNER**, or **AUX/PORT. IN** on the unit or **FUNCTION** on the remote control.

One track/file recording - You can record to USB after playing a track/file you want.

All tracks/files recording - You can record to USB after stop.

Program list recording - After showing the programmed list, you can record it to USB.
(Refer to the page 17)

3. Press **R** **USB REC** on the unit or **USB REC** on the remote control.
- If you connect both of USB1 and USB2, press **>|| ST./MONO** to record to USB1 or press **□** to record to USB2.
4. To stop recording, press **□** on the unit or **■ ENTER** on the remote control.

To select recording bit rate and speed

1. Press **R** **USB REC** on the unit or **USB REC** on the remote control for longer than 3 seconds.
2. Press **◀◀/▶▶** on the remote control or **|◀/▶|** on the unit to select a bit rate.
3. Press **R** **USB REC** on the unit or **USB REC** on the remote control again to select the recording speed.
4. Press **◀◀/▶▶** on the remote control or **|◀/▶|** on the unit to select a desired recording speed. (AUDIO CD only)

X1 SPEED

- You can listen to music while recording it.

X2 SPEED

- You can just record the music file.

5. Press **R** **USB REC** on the unit or **USB REC** on the remote control to finish the setting.

Dubbing USB to USB

You can do dubbing a various sound source in USB1 to USB2 on USB function.

1. Connect a USB device including desired sound files to USB1.
2. Connect another USB device to USB2.
3. Press **⏮** **USB REC** on the unit or **USB REC** on the remote control.
4. To stop recording, press **⏮** on the unit or **ENTER** on the remote control.

Pausing recording

During recording, press **⏮** **USB REC** on the unit or **USB REC** on the remote control to pause recording. Press it again to restart recording. (TUNER/AUX/PORTABLE only)

Note

- You can check the recording percentage rate for the USB record on the display window during the recording. (MP3/WMA, CD Only)
- During recording MP3/WMA, there is no sound.
- When you stop recording during playback, the file that has been recorded at that time will be stored. (Except MP3/WMA files)
- Do not remove the USB device or turn off the unit during USB recording. If not, an incomplete file may be made and not deleted on PC.
- If USB recording does not work, the message like "NO USB", "ERROR", "USB FULL" or "NO REC" is displayed on the display window.
- Multi card reader device or External HDD can not be used for USB recording.
- A file is recorded by about 512 Mbyte when you record for a long term.
- You may not store more than 999 files.
- It'll be stored as follows.

AUDIO CD	MP3/WMA	The other source*
■ CD_REC TRK_001 TRK_002 ⋮	■ FILE_REC ABC(File name) DEF(File name) ⋮	■ EXT_REC AUDIO_001 AUDIO_002 ⋮

* : TUNER, AUX and the like.

The making of unauthorized copies of copy-protected material, including computer programs, files, broadcasts and sound recordings, may be an infringement of copyrights and constitute a criminal offense. This equipment should not be used for such purposes.

Be responsible
Respect copyrights

Troubleshooting

General

Problem	Cause & Solution
No Power.	<ul style="list-style-type: none"> • The power cord is not plugged in. Plug in the power cord. • Check whether electricity failed. Check the condition by operating other electronic devices.
No sound.	<ul style="list-style-type: none"> • Check whether you select right function. Press FUNCTION and check the selected function. • If not, connect speaker cables correctly. Speaker cables connected correctly.
No beat box sound.	<ul style="list-style-type: none"> • Check the beat box volume level by rotating BEAT VOL./SELECT.
The unit does not start playback.	<ul style="list-style-type: none"> • An unplayable disc is inserted. Check the playable disc. • No disc is inserted. Insert a disc. • The disc is dirty. Clean the disc. (Refer to the 29 page) • The disc is inserted upside down. Place the disc with the label or printed side facing upwards.
Radio stations cannot be tuned in properly.	<ul style="list-style-type: none"> • The antenna is positioned or connected poorly. Connect the antenna securely. • The signal strength of the radio station is too weak. Tune to the station manually. • No stations have been preset or preset stations have been cleared (when tuning by scanning preset channels). Preset some radio stations, see page 19 for details.
The remote control does not work properly.	<ul style="list-style-type: none"> • The remote control is too far from the unit. Operate the remote control within about 23 ft (7 m). • There is an obstacle in the path of the remote control and the unit. Remove the obstacle. • The batteries in the remote control are exhausted. Replace the batteries with new ones.
Sub woofer does not work.	<ul style="list-style-type: none"> • Check whether the woofer is connected to the unit correctly. Connect cables to the unit correctly. (Refer to the 12 page) • Check the woofer status and press WOOFER ON/OFF.

Trademarks and Licenses



General specifications

General	
Power requirements	Refer to main label
Power consumption	Refer to main label
Dimensions (W x H x D)	285 x 395 x 381 mm
Net Weight (Approx.)	6.2 kg
Operating temperature	5 °C to 35 °C (41 °F to 95 °F)
Operating humidity	5 % to 90 %
Bus Power Supply	USB DC 5 V  500 mA

Inputs	
AUX IN	2.0 Vrms (1 kHz, 0 dB), 600 Ω, RCA jack (L, R) x 1
PORT. IN	1.2 Vrms (3.5 mm stereo jack)

Tuner	
FM Tuning Range	87.5 to 108.0 MHz or 87.50 to 108.00 MHz
AM Tuning Range	522 to 1 620 kHz, 520 to 1 710 kHz or 522 to 1 710 kHz

Amplifier		
Stereo mode		310 W + 310 W (4 Ω at 1 kHz, THD 10%)
Surround mode	Front	310 W x 2 (4 Ω at 1 kHz, THD 10%)
	Rear	180 W x 2 (8 Ω at 1 kHz, THD 10%)
	Subwoofer	310 W x 2 (4 Ω at 1 kHz, THD 10%)

CD	
Frequency Response	40 to 20 000 Hz
Signal-to-noise ratio	75 dB
Dynamic range	80 dB

Speaker specifications

Front speaker	
Type	2 Way 2 speaker
Impedance	4 Ω
Rated Input Power	310 W
Max. Input power	620 W
Net Dimensions (W x H x D)	262 x 475 x 330 mm
Net Weight	7.8 kg

Rear speaker	
Type	2 Way 2 speaker
Impedance	8 Ω
Rated Input Power	180 W
Max. Input power	360 W
Net Dimensions (W x H x D)	262 x 475 x 330 mm
Net Weight	3.5 kg

subwoofer	
Type	1 Way 1 speaker
Impedance	4 Ω
Rated Input Power	310 W
Max. Input power	620 W
Net Dimensions (W x H x D)	346 x 450 x 331 mm
Net Weight	9.3 kg

- Design and specifications are subject to change without notice.

Maintenance

Notes on Discs

Handling Discs

Never stick paper or tape on the disc.

Storing Discs

After playing, store the disc in its case. Do not expose the disc to direct sunlight or sources of heat and never leave it in a parked car exposed to direct sunlight.

Cleaning Discs

Fingerprints and dust on the disc can cause poor picture quality and sound distortion. Before playing, clean the disc with a clean cloth. Wipe the disc from the center to out.

Do not use strong solvents such as alcohol, benzine, thinner, commercially available cleaners, or anti-static spray intended for old vinyl records.

Handling the Unit

When shipping the unit

Please save the original shipping carton and packing materials. If you need to ship the unit, for maximum protection, re-pack the unit as it was originally packed at the factory.

Keeping the exterior surfaces clean

Do not use volatile liquids such as insecticide spray near the unit. Wiping with strong pressure may damage the surface. Do not leave rubber or plastic products in contact with the unit for a long period of time.

Cleaning the unit

To clean the player, use a soft, dry cloth. If the surfaces are extremely dirty, use a soft cloth lightly moistened with a mild detergent solution. Do not use strong solvents such as alcohol, benzine, or thinner, as these might damage the surface of the unit.

Maintaining the Unit

The unit is a high-tech, precision device. If the optical pick-up lens and disc drive parts are dirty or worn, the picture quality could be diminished. For details, please contact your nearest authorized service center.

