



Operating Instructions

Built in Oven

Please read this instruction manual carefully before using the oven. This will ensure that you know the important safety information and the correct operation of the oven.

Please keep this manual in a easily accessible place and refer to it anytime. Please transfer this manual to new owner if you sell the oven.

ES441S



3828W5A4645

www.lg.com

표2는 백지

Foreword

Dear Customer,

You have purchased a high-quality appliance from our Company. Thank you for your custom.

To ensure many years of pleasure in the use of your oven, and to familiarise yourself with all of the appliance's functions, please read through this Instruction Manual carefully.

Please pay particular attention to the section containing safety instructions in the first few pages.

Keep the Instruction Manual in a safe place for reference if questions should arise. If you should sell the appliance on, please pass the Instruction Manual on to the new owner.

Contents

Safety	6~10
Appliance description	11
Control panel	12~13
Accessories	14~15
Telescopic slides (special accessory)	16~17
Before initial use	18
Setting the time of day	18
Initial cleaning	19
Using the oven	20~37
Operating modes	20~23
Switching the oven on	24
Changing the oven temperature	25
Switching the oven off	26
Safety cut-out	27
Clock functions and symbols	28
Setting the timers	29
Programming the overall cooking / baking time	30~31
Programming the end of cooking / baking time	32~33
Combining overall cooking / baking time and end of cooking/ baking time	34~35
Setting the time of day.....	36
Childproof safety device	37
Baking	38~39
Baking table	40~44
Roasting	45
Roasting table	46~47
Grilling	48~49
Grilling table	49
Defrosting	50

Defrosting table	50
Special functions	51
Yoghurt making	51
Letting dough rise.....	51
Test dishes as per 44547	52~53
Cleaning and care	54~57
Oven light	58
Oven door	59~65
Troubleshooting	66~67
Error codes	68
Technical specifications	69
Installation instructions	70
Customer service & spare parts	71

Safety

Proper use

Use the oven only for the preparation of foodstuffs in your home. Do not use the oven other than as indicated in this Instruction Manual.

No other application or use is permitted and may be dangerous.

Do not use the oven to heat rooms. Because of the high temperatures inside the oven, easily inflammable objects in the vicinity may start to burn.

The manufacturer is not liable for any damages caused by improper use.

General safety instructions

Electrical Safety

- Before connecting the appliance, check that the details on the rating plate are compatible with your power supply. (The rating plate is located to the left on the inside of the door).
- If the appliance has been visibly damaged during transportation, do not use. In these circumstances, contact your supplier or the LG Service Centre.
- You must arrange for the appliance to be connected by a qualified professional electrician only.
Electrical safety is only guaranteed if the appliance is connected to a properly- installed protective system with an earth conductor. Improper installation can give rise to considerable risks and damage for which the manufacturer accepts no liability.
- In the event of any damage or any fault in the appliance, disconnect from the power supply by
 - completely removing or switching off safety fuse for the building installation,
 - disconnecting the mains plug.

-
- Do not pull the plug out of its socket by the cable, but always by gripping the plug itself.
 - If the mains supply cable is damaged, it must be replaced with a special cable fitted by a qualified electrician to avoid any risk. This cable is available from the manufacturer or your specialist dealer.
 - The oven must be connected to the power supply using an all-pole isolating switch with a contact gap of at least 3 mm.
 - Multiple adaptors or extension cables must not be used.
 - You must arrange for the appliance to be repaired by a qualified professional electrician only. Contact our LG Service Centre or your specialist dealer.
 - Proceed with caution when connecting electrical appliances to sockets in the vicinity of this appliance: electrical cables must not be run near the hotplate cooking area or oven doors. Cables can melt with the subsequent risk of a short circuit.
 - Switch the machine off before changing the oven light bulb to avoid any risk of electric shock.

Safety

Safety during operation

Warning!

- When the oven is in use, the following areas heat up:
 - the inside of the oven, especially the heating elements;
 - the switches, and the oven door handle after extended operation.There is a risk of being burned. You should therefore keep children away from the oven.
- If you are using ingredients containing alcohol in the oven, a flammable mixture of air and alcohol may be created. In this case, open the oven door with care. Avoid any naked light, sparks or flames in the vicinity of the oven.
- Accessible parts may become hot during use. Young children should be kept away.
- Accessible parts may become hot when the grill is in use. Children should be kept away.
- When opening the door in the course of cooking, the upper heating elements will remain on for 10 minutes if they were already in operation prior to the door being opened. This reduces heat loss and heating recovery time when the door remains opened for longer periods.

Warning!

- When the grill is in use, exposed parts of the oven may become hot. You should keep children at a distance.
- This appliance is not intended for use by persons (including children) with reduced physical, sensory or mental capabilities, or lack of experience and knowledge, unless they have been given supervision or instruction concerning use of the appliance by a person responsible for their safety.

Safety during cleaning

Warning!

- Do not clean the appliance using steam-jet or high-pressure cleaners. The steam may give rise to short-circuiting in live components.

How to avoid damage to your appliance:

- Do not place any aluminium foil, baking trays, pots or the like directly on the oven floor. The resulting build-up of heat can cause damage to the enamel floor.
- Cook deep-frozen foodstuffs such as pizza on the shelves and not on the oven trays. Because of the great temperature difference created, oven trays can warp.
- Fruit juices dripping from the baking tray cause marks which cannot be removed. For very moist cakes use only the deep pan.
- Do not apply any load to the open oven door.
- Never pour water straight into the hot oven. Because of the water vapour produced, this can result in burns, electrical malfunctions or damage to the enamel floor.
- Treat your oven with care to avoid damage (e.g. the glass insert panels in the oven doors).
- Never store any flammable materials inside the oven, as these may be ignited when the oven is switched on.
- Never store any foodstuffs inside the oven, as this can cause damage to the enamel surface.
- Do not use harsh abrasive cleaners or sharp metal scrapers to clean the oven door glass since they can scratch the surface, which may result in shattering of the glass.
- This connection may be achieved by having the plug accessible or by incorporation a switch in the fixed wiring in accordance with the wiring rules.

Safety

Disposal

Packaging material

- Your new oven has been correctly packaged for transportation. Remove all of the packaging material before putting the appliance into use.
- The packaging material can be completely recycled. You can obtain addresses for environmentally-friendly disposal operations from your local authority.

Used appliances

Warning!

- Used appliances must be rendered unusable prior to disposal so that they no longer present a risk. To achieve this, disconnect from the mains supply and remove the power supply cable.

For the protection of the environment, used appliances must be disposed of properly.

- The appliance must not be disposed of along with normal domestic waste.
- Your local authority will inform you of times for uplifting special waste or identify public disposal facilities for you.

Appliance description

Overview

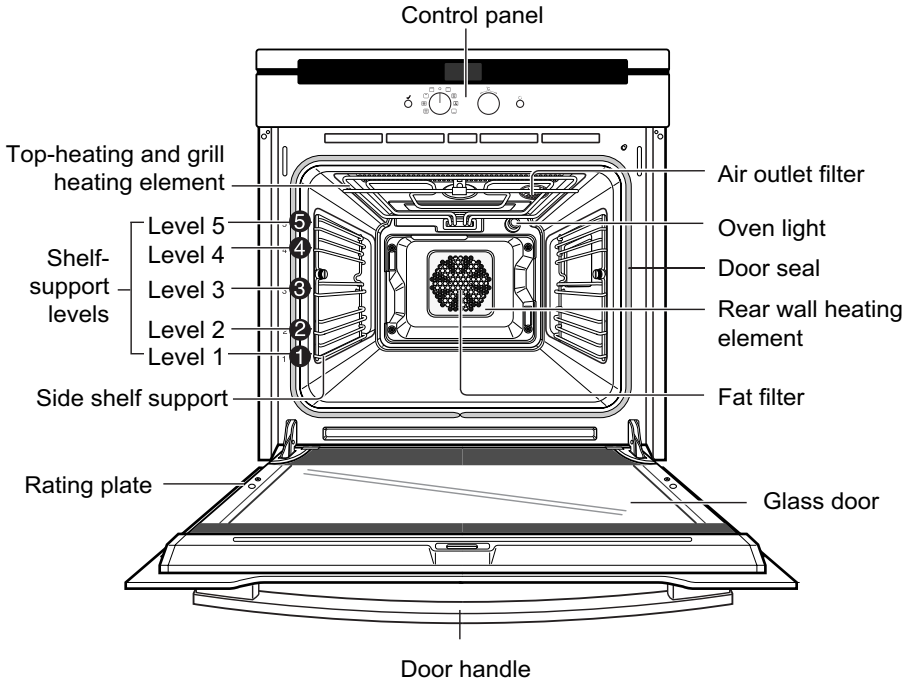

Oven levels are numbered from the bottom up.

The 4 and 5 levels are mainly used for grill functions. Always grill with the door closed.

The cooking tables throughout this operating instructions give you suggested oven level (shelf positions), however you can change these to suit yourself.

Control Panel

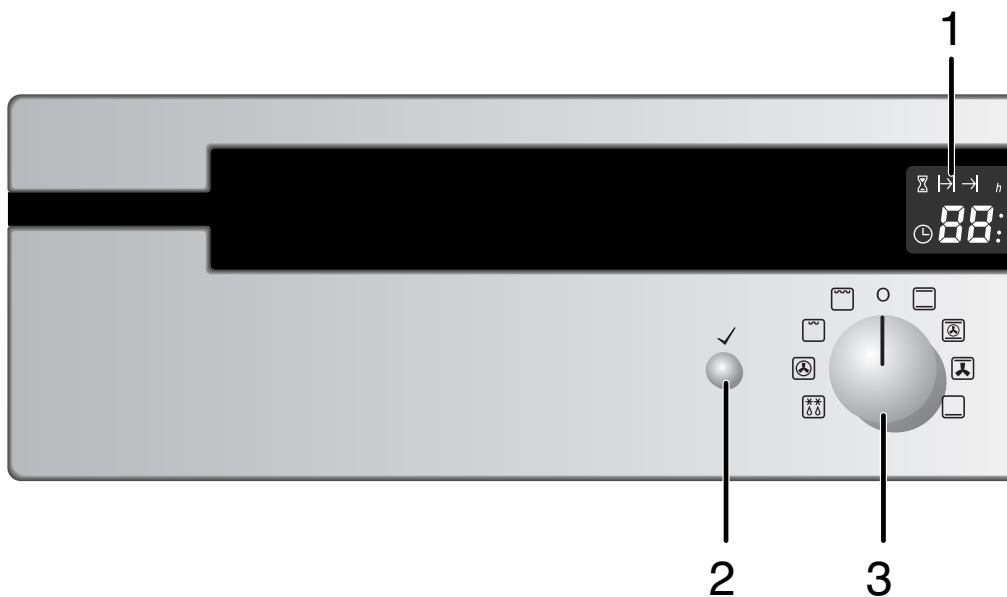

1. Time/Temperature display
2. OK button
3. Operating mode knob (for setting operating mode)
4. Temperature/Control knob (for setting temperature, grill settings 1 - 3)
5. Timer/Clock button

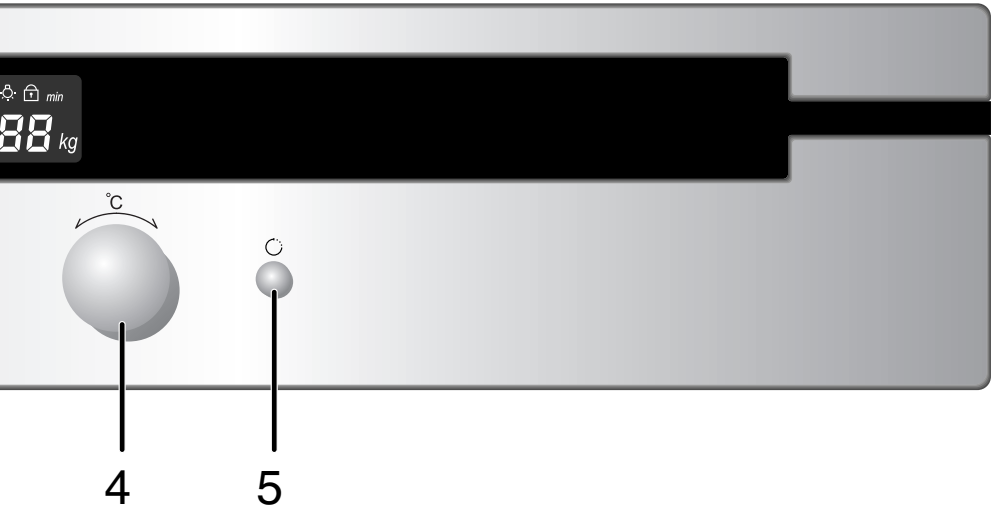

TIP

Push the knobs and control knobs in to recess flush.
Press them briefly to bring them back out for use.

Accessories

Wire grill

For dishes, baking tins, grilling and roasting tins.

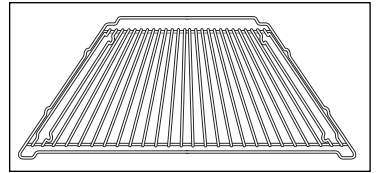

Baking tray

For cakes, sponges and biscuits.

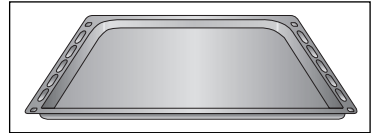

Deep pan

For juicy cakes, for roasting and for catching roasting juices or fat.

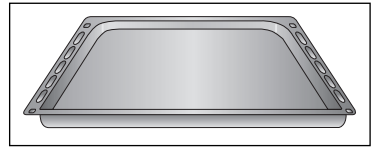

Grill tray

For fatty meat (for positioning in the Deep pan). For grilling and/or roasting, we recommend using the grill/roast system provided. The Grill tray sits inside the Deep pan so they can be placed in the oven together.

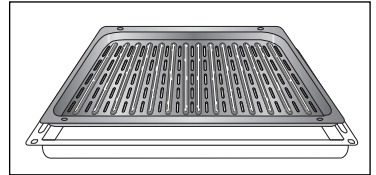

Grill rack

You can use Grill rack instead of Grill tray, if necessary, for effective cooking performance.

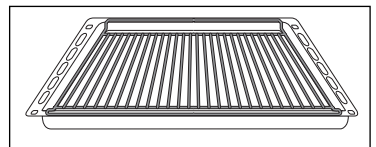

Fat filter

To protect the fan from accumulations of grease when roasting with 3D hot air, convection heat or the convection grill. Attach the fat filter by its hooks to the openings in the fan cover. The fat filter must completely cover the opening.

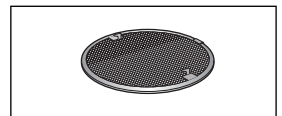

TIP

Do not use the fat filter when baking, as this extends the baking time and you will consume more electricity.

Hints on using the trays and shelves

Ensure that the trays and shelves are properly fitted into the two side shelf supports. Take particular care when removing finished dishes and meals from the oven! Use suitable cloth pot holder or oven gloves.

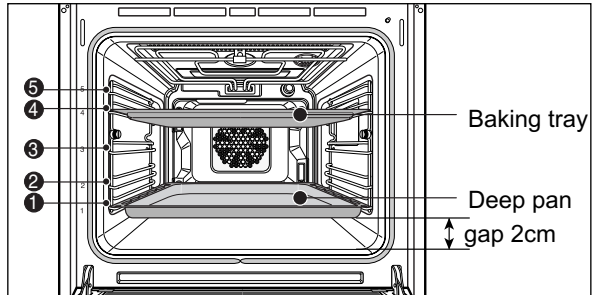

If you are using the grill grid in combination with the deep pan or some other tray to catch dripping liquids or fat, then do not put the trays down on the oven floor, but slide them into the shelf supports as well. If you place trays on the oven floor, the resulting build-up of heat can damage the surface of the oven. For this reason, there must always be a minimum gap of 2 cm between the accessories and the oven floor. With grill grids, always ensure that they are properly in position in the shelf supports.

Fitting the grill grid, baking tray and deep pan

Slide the tray or shelf in at the desired level.

The shelf support levels are numbered from the bottom up to the top.

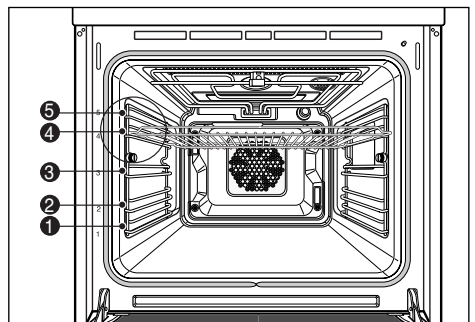

Telescopic slides (special accessory)

Installation

The telescopic slides are installed as follows:

1. Put the inserting bar of the telescopic slide into the hole.

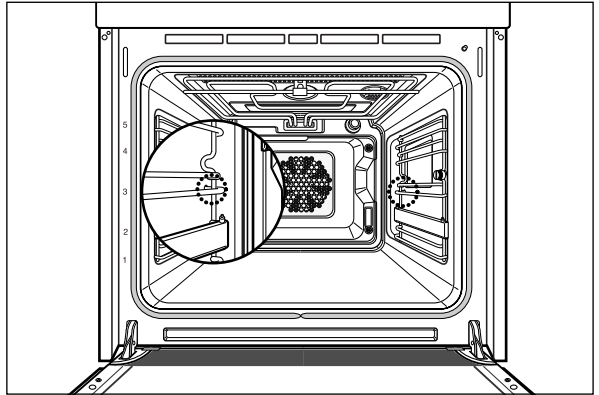

2. Align the front recess with the front screw hole. Turn a screw in and tighten both screws. Repeat the procedure for the second telescopic slide arm.

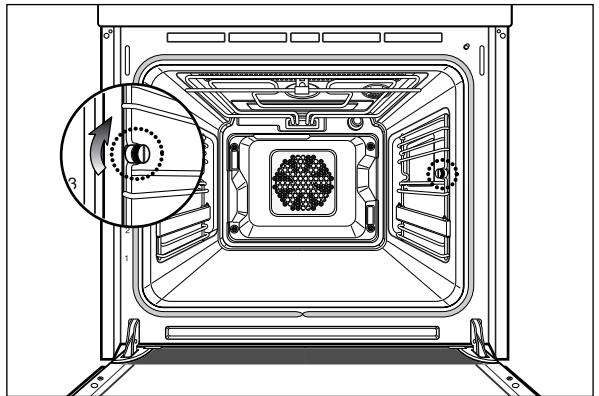

3. Trays and shelves must be placed on the telescopic slide arms with care so as to avoid any accidental tipping over. To prevent this, place trays and shelves on the telescopic slide arms as shown in the illustration below, so that the securing pins on the slide arm catch the tray or shelf to prevent any slipping.

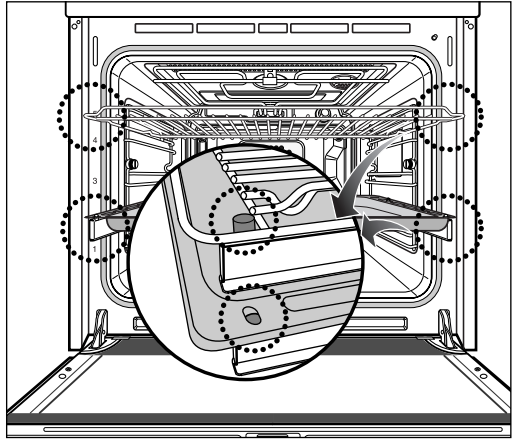

Before initial use

Setting the time of day

The oven cannot be used until the time of day is set.

When the appliance is connected for the first time or after a power failure, the time display flashes at "0:00".

Example: to set the current time of day to 1:30:



- 1** Turn the Temp./Control knob to set hour of current time.

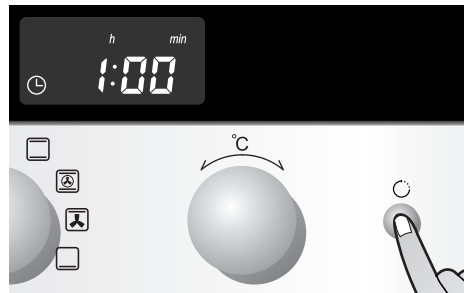

- 2** Press the Timer/Clock button (⌚).
The <00> will blink.

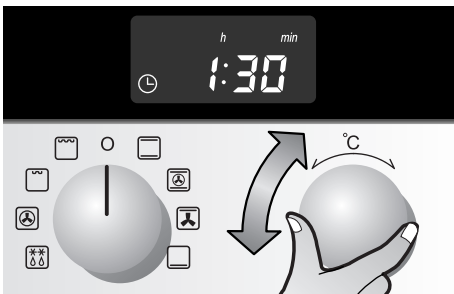

- 3** Turn the Temp./Control knob to set minute of current time.

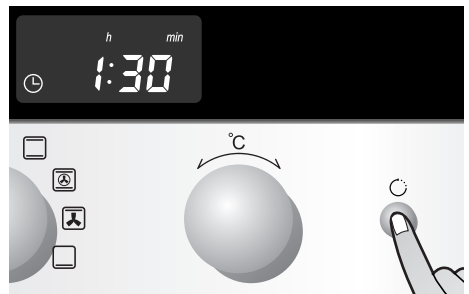

- 4** Confirm by pressing the Timer/Clock button (⌚).
The appliance is now ready to use.

Initial cleaning

Clean the oven carefully before putting it into use.

Important: Do not use any caustic or abrasive cleaners. These can damage the oven surfaces.

Appliance front

Ovens with a metal front must be cleaned with standard detergents only. Wipe the front of the appliance with a slightly damp cloth.



Oven interior

1. Open the oven door. The oven light comes on.
2. Clean all baking trays, accessories and the side shelf supports with warm water and dishwashing liquid.
3. Clean the oven interior in the same way, using warm water and dishwashing liquid.
4. Allow the oven to dry.

Heating up

Before baking or roasting, heat up the oven, the first time it is switched on an unpleasant smell may arise.

Open the windows and ensure there is adequate ventilation during this procedure.

1. Ensure that the time of day is set correctly.
2. Remove all accessories from the oven.
3. Use the knob to select the operating mode: 3D Hot Air() or Convection grill() at 200°C (see next page).
4. Leave the oven on in this operating mode for one hour.

Using the oven

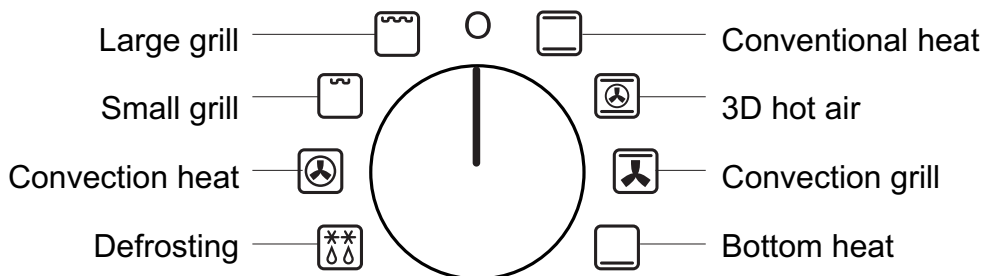

Operating modes



Description of operating modes

The individual operating modes differ in that they involve a combination of different heating elements. The various combinations are suitable for producing a variety of heated areas and Convection heat circulation paths in the oven, as required for the optimum preparation of various dishes.

For the roasting and baking functions there are preset recommended temperatures which you can, of course, adjust using the "Temperature" knob.

When using the grill functions () (), you can use the "Temperature" knob to select any of three settings in each case.

When using the defrosting (), there are no other settings available.

Conventional heat

For conventional heat, the heating elements above and below the baking chamber are used. This operating mode is suitable for baking cakes, baking with a short baking time, sensitive doughs and for roast beef and fillet of beef on the one level. The recommended temperature is 190°C.

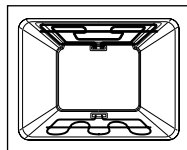

3D hot air

In addition to the conventional heat elements, 3D hot air mode uses the heating element in the back wall and the hot-air fan. This means that the roasting and baking temperature can be reduced by 20-40°C. The preset temperature is 150°C. This mode is suitable for cakes and biscuits, as it is possible to bake on more than one level at the same time.

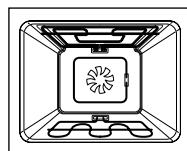

Convection grill

In this mode, the grill element is used in convection heat mode. The recommended temperature is 190°C. This function is suitable for pizzas, quiche lorraine or cheesecakes.

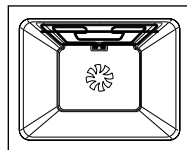

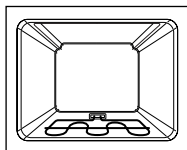

Bottom heat

In bottom heat mode, only the heating element in the oven floor is used. The recommended temperature is 170°C. This function is particularly suitable for finishing off cakes or pizzas supposed to have a crispy base, on one of the shelf support levels.



Using the oven

Large grill (Settings 1, 2, 3)

The large grill () uses the entire heating element. No specific temperature can be set. You can choose between three settings. The large grill () is suitable for cooking steaks, cutlets, fish or making toast, and when cooking larger quantities for browning or with a gratin topping.

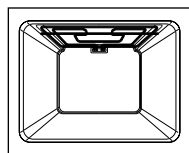

Small grill (Setting 1, 2, 3)

The small grill operates in the same way as the large grill () , however, only part of the top heating element is used. This makes it suitable for smaller quantities.

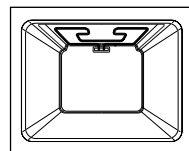

Convection heat

Convection heat mode uses only the heating element in the back wall and the convection heat fan. Accordingly, at 200°C, the recommended temperature is higher than that for 3D hot air ().

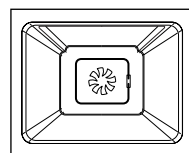

It is also possible to bake on more than one level in convection heat () mode. This means that it is suitable for fruit cakes and stirred cake or yeast-dough, for example a bread plait.

Defrosting

In defrosting mode, the fan is used without heating. The circulating air speeds up the defrosting process. Place the frozen food in a suitable container to trap the liquid produced during defrosting. Where appropriate, you can use the grill grid and the deep pan to avoid soiling the oven. If water is allowed to run out into the oven, the door seals will be contaminated and an unpleasant odour may result.

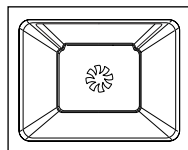

NB: During cooking, baking or roasting, when you open the door to turn or baste dishes, the oven switches off. If you leave the door open for more than 10 minutes, all settings are cancelled. When opening the door in the course of cooking, the upper heating elements will remain on for 10 minutes if they were already in operation prior to the door being opened. This reduces heat loss and heating recovery time when the door remains opened for longer periods.

Using the oven

Switching the oven on

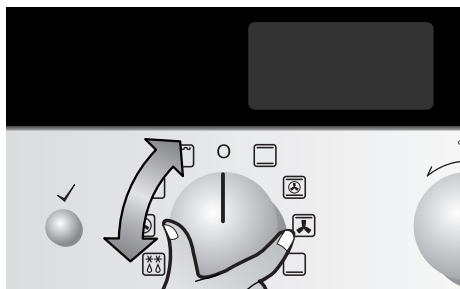

1 Select the desired mode with the Operating mode knob.



2 The relevant recommended temperature is shown in the display.

3 Start operation by pressing the OK button(✓) or wait until the oven starts automatically in 8 seconds. You will hear a signal tone and the symbol now remains lit without flashing. If you do not apply any further settings on the control panel, the oven will remain on for the maximum possible time (approximately 8 hours).

NB: The oven light goes out after 20 seconds to save electricity.

The light can be switched back on at any time by pressing the oven light button.

Changing the oven temperature

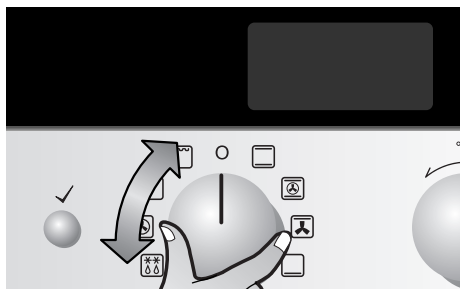

- 1 Select the desired mode with the Operating mode knob.



- 2 Set the desired baking temperature with the Temp./Control knob.

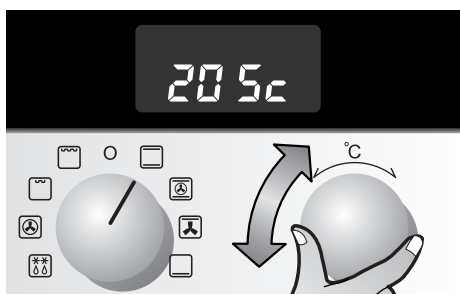

- 3 The temperature display appears in 5°C increments.

Note

If the oven is heated to preset oven temperature, the temperature in the display will blink.

- 4 If you do not press any buttons within 8 seconds, the oven automatically starts under the set programme. You can also start the oven by pressing the OK button(✓). You will hear a signal tone and the symbol now remains lit without flashing.

Using the oven

Switching the oven off

Set the Operating mode knob to "O" to switch the oven off.

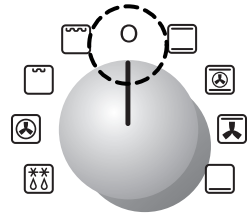

Oven fan

When the oven is switched on, the fan is automatically activated to cool the oven surfaces. When the oven is switched off, the fan runs on and only switches off once the appliance has cooled down.

Residual Heat Indicator

The residual heat is indicated until the temperature has gone down to 60°C.

Safety cut-out

- If the oven has been operating for an extended period with no change in settings, it is automatically switched off.

The safety cut-out device is activated at a temperature of:

below 100°C switches off after 16 hours

100°C ~ 250°C switches off after 8 hours

Restarting after safety cut-out

Switch the oven off.

You can now start the oven in the normal way.

Thermal cut-out

If the oven should overheat, the power supply to the heating elements is switched off for a period of time so as to avoid any damage to the appliance.

Baking dishes

When using baking dishes, always ensure that the dish is suitable for use at the temperature inside the oven. The oven can operate at up to 250°C. Refer to the instructions provided by the manufacturer of the dish.

Using the oven

Clock functions and symbols

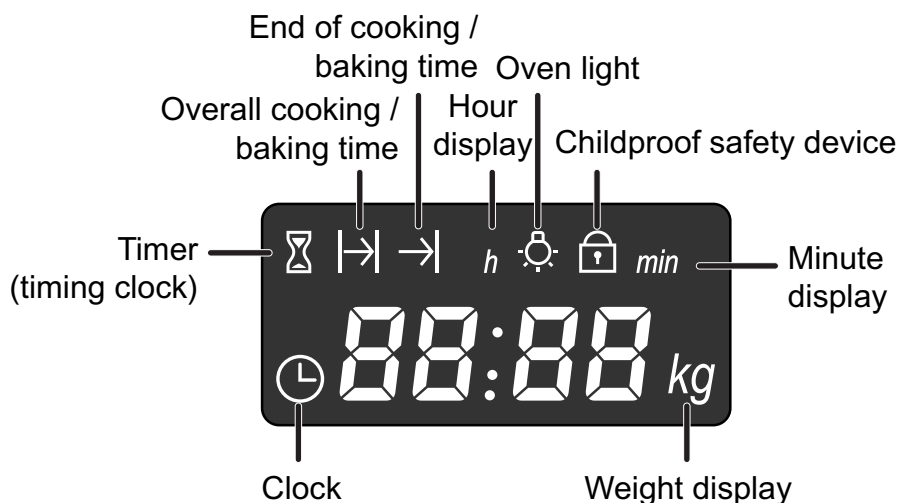

Timer

Lights up when the function timer is activated (e.g. like a minute minder when boiling eggs).

Overall cooking time

Lights up when the overall cooking time is being set or displayed. The oven switches off automatically after the cooking time set has expired.

End of cooking time

Lights up when the point in time set for the end of the cooking / baking time set or displayed. The oven switches off automatically at the stipulated time.

NB: Overall cooking time and end of cooking time can only be programmed with an operating mode selected.

Clock

Lights up when the time is being set, changed or displayed.

Setting the timers

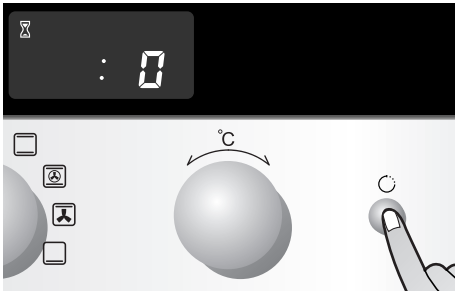

- 1** Press the Timer/Clock button once.

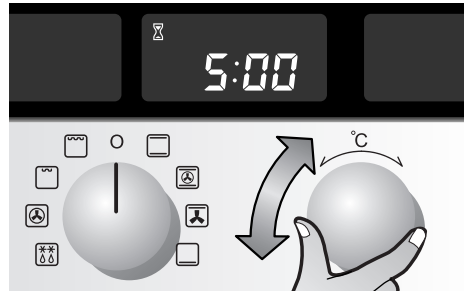

- 2** Set the desired time with the Temp./Control knob .

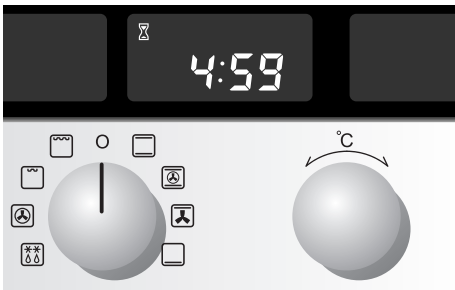

- 3** Press the OK button to start the timer clock. Once the set time has expired, the egg-timer symbol flashes and you will hear a signal tone.

* Switching off the signal tone

Press OK button to cancel the signal tone.

The light can be switched on and the light goes out after 20 seconds.

Using the oven

Programming the overall cooking / baking time

The oven switches off automatically at the end of the period of time entered.

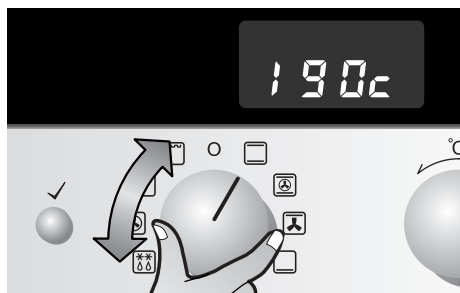

- 1** Select the desired Operating mode and temperature. (Refer to the section on "Switching the oven on" or "Changing the oven temperature").

NB: If you do not apply any other settings in the next 8 seconds, the oven automatically starts the selected programme.

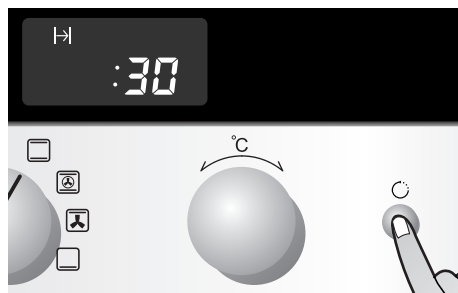

- 2** Press the Timer/Clock button (⌚) twice to set the overall cooking



- 3** Set the desired overall cooking / baking time with the Temp./Control knob. The programme starts automatically in 8 seconds, or you can start the programme yourself by pressing the OK button(✓) twice right away. (The oven lamp turns on.)
- 4** Once the set time has expired, you will hear a signal tone and the oven switches off. Press the OK button to cancel the signal tone.
The light can be switched on and the light goes out after 20 seconds.

Using the oven

Programming the end of cooking / baking time

The oven switches off automatically at the time entered.

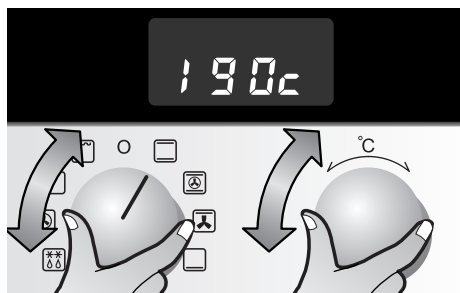

- 1** Select the desired operating mode and temperature.

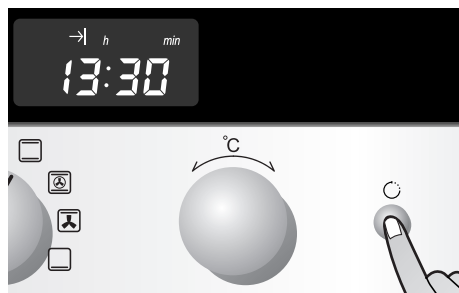

- 2** Press the Timer/Clock button three times. In the example shown, the current time is 13:30 and the dish is to be ready at 14:30. The hour display is a flashing 13.

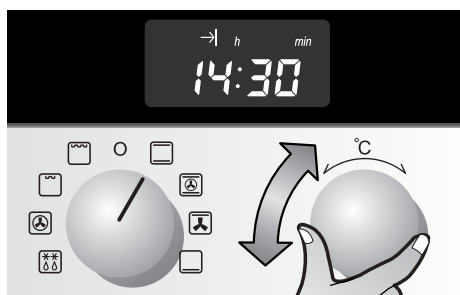

- 3** Now set the hour at which the programme is to finish (14, in the example).



- 4** Confirm the entry by pressing the Timer/Clock button. The minutes flash.

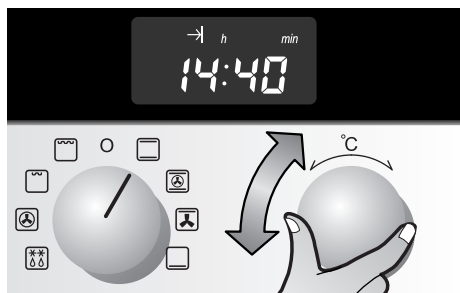

5 Now set the minutes with the Temp./Control knob (40, in the example).

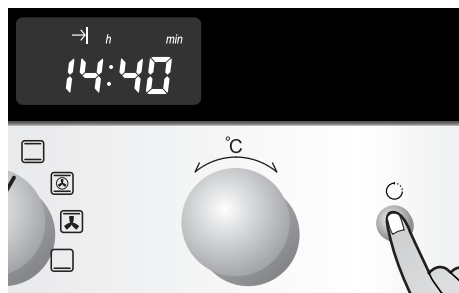

6 Start the programme by pressing the Timer/Clock button. The time remaining is shown in the display. Once this time has expired you will hear a signal tone and the oven will switch off automatically. Press the OK button or OK button to cancel the audible signal tone.

Using the oven

Combining overall cooking / baking time and end of cooking/ baking time

The overall and end of cooking time programmes can be combined to permit the oven to be switched on and off automatically.

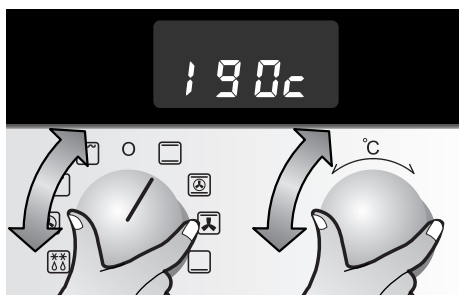

- 1 Select the desired operating mode and temperature.



- 2 Press the Timer/Clock button (⌚) twice to set the overall cooking. Set the desired overall cooking time with the control knob, e.g. 60 min. NB: if the overall cooking time is more than 60 minutes, the display mode switches from "Minutes : Seconds" to "Hours : Minutes".

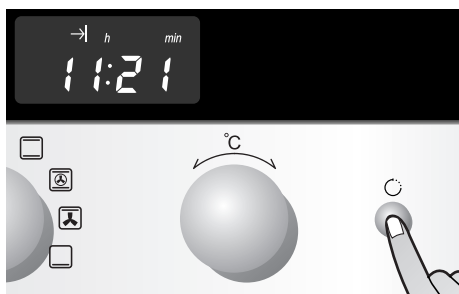

- 3 Now press the Timer/Clock button once to set the end of cooking before starting the oven and set the time at which the programme is to finish (12:05, in the example shown).

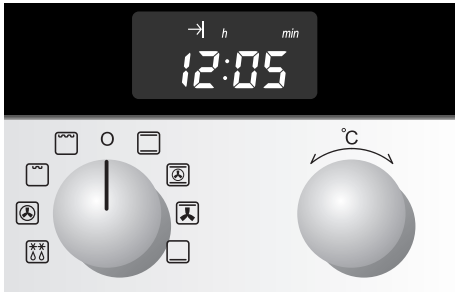

4 To set this time, first select the hours with the control knob (12, in the example). Confirm the entry with the Timer/Clock button. Then select the minutes with the control knob (5, in the example). Confirm the entry with the End of cooking / baking time button. The finishing time for the programme (12:05, in the example) is shown in the display.

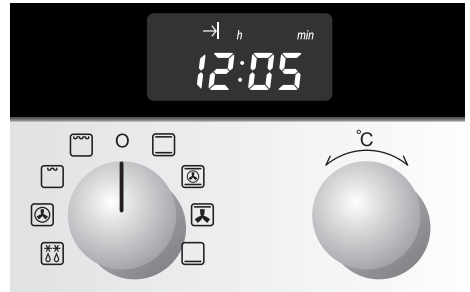

5 60 minutes before the End of cooking / baking time, the oven switches on automatically, at 11:05 in the example shown. The time countdown can then be seen in the display. Once the set cooking time has expired, you will hear a signal tone and the oven will switch off automatically.

Using the oven

Setting the time of day

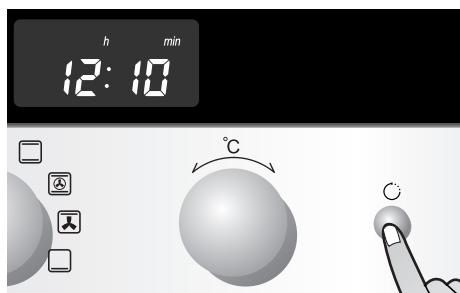

- 1 Set the Operating mode control knob to 0. Press the Timer/Clock button twice to enter the required mode for setting the time of day. The clock display flashes (12:10, in the example).

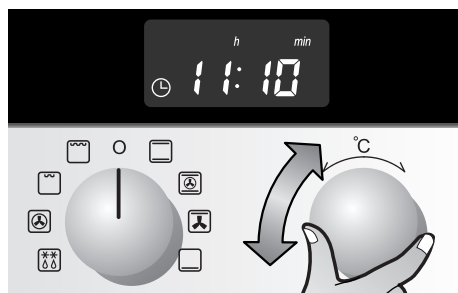

- 2 Select a new value for the hour with the Temp./Control knob (11, in the example).

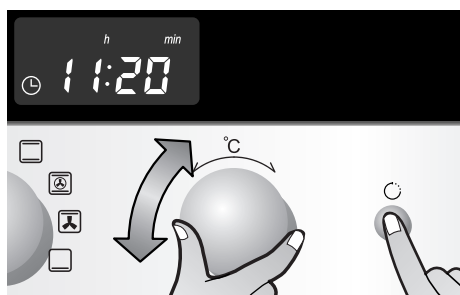

- 3 Press the Timer/Clock button to confirm. The minute display starts to flash. Set the new value for minutes with the Temp./Control knob (20, in the example).



- 4 Press the Timer/Clock button to confirm the entry.

NB: The time of day can only be set with the oven switched off and the childproof safety device deactivated.

Childproof safety device

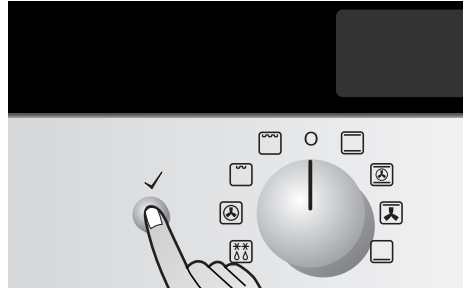

The childproof safety device prevents the oven being switched unintentionally.

1. Press the OK button (✓). Hold it down for 10 seconds until the Lock symbol (🔒) appears in the display. The childproof safety device is now activated.
2. To switch off the childproof safety device, press the OK button (✓) until the Lock symbol (🔒) is no longer displayed. The childproof safety device is now deactivated and the oven is ready for use.



Baking

General information





When baking, use the 3D hot air() or conventional heat() modes.

TIP

Remove the fat filter when baking.

If the filter is not removed, the baking time is extended and your baking will be browned unevenly.

Baking tins

- When baking in conventional heat() modes, use baking tins with a dark metal or coated surface.
- When baking with 3D hot air() or convection heat(), you can also use baking tins with a bright metal surface.
- Always place baking trays in the oven with the flat side to the front.
- Always place cake tins in the middle of the tray or shelf.
- When baking with 3D hot air() or conventional heat, you can place two baking tins side by side in the oven. This means that the baking time is only slightly longer.
- When using 2 trays (baking tray and deep pan), place the deep pan on Level 4 and the baking tray on Level 2.

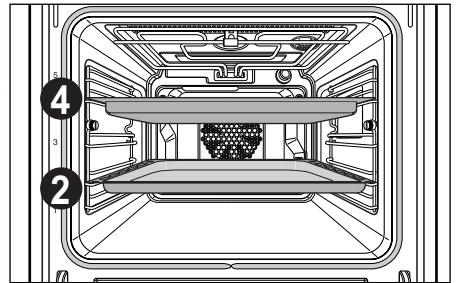

Shelf levels

The shelf levels are numbered from the bottom up.

When using conventional heat, you can bake on one level only, for example Level 3.

When using 3D hot air(), you can bake sponge bases and biscuits on up to 2 baking trays at the same time, for example on Levels 2 and 4.

Using baking tables

The tables contain the temperature settings, baking time and shelf levels for a selection of typical dishes.

- Temperatures and baking times should be regarded as reference figures only. The actual values depend on the type of preparation, quality of ingredients and the baking tin in use.
- We recommend first selecting a lower temperature and then increasing it if necessary, for example if you want a higher degree of browning or the baking time is too long.
- If you cannot work out the settings for a specific recipe, simply use the settings for the most similar recipe.
- When baking cakes on baking trays or in tins on more than one level, the baking time may be extended by 10–15 minutes.
- Baking with a high liquidity content (e.g. pizza, fruit cakes, etc.) should be baked on a single level only.
- With cakes and baking with different levels of dough, uneven browning may take place initially. **In this case do not alter the temperature setting.** The degree of browning will even itself out over the baking process.

NB:

Over extended baking times, the oven may be switched off about 10 minutes before the end of baking time. Make use of the residual heat available.

The times stated in the table apply only for an oven which has not been preheated. Preheating the oven reduces the time by about 10 minutes.

Baking table

Baking on a single shelf level

Operating mode	3D hot air		Conventional Heat		Baking time
Recipe	Shelf level	Temp. in °C	Shelf level	Temp. in °C	For both types of baking, in hrs, mins.
Cakes in baking tins					
Ring-shaped pound cake	1	150–160	1	160–180	0:50–1:10
Biscuits / pancakes	1	140–160	1	150–170	1:10–1:30
Sponge finger	1	150–160	1	160–180	0:25–0:40
Flan base – shortcrust pastry	3	170–180	2	190–210 ¹	0:10–0:25
Flan base – cake mixture	3	150–170	2	170–190	0:20–0:25
Apple pie	1	150–170	1	170–190	0:50–1:00
Spicy cakes and flan base (e.g. quiche lorraine)	1	160–180	1	190–210	0:30–1:10
Cheesecake	1	140–160	1	170–190	1:00–1:30
Cakes on baking tray					
Bread plaits / larger cakes	3	160–170	3	170–190	0:30–0:40
Christmas stollen	3	150–170 ¹	3	160–180 ¹	0:40–1:00
Bread (rye bread) initially, then later	1	180–200 ¹ 140–160	2	230 ¹ 160–180	0:20 0:30–1:00
Pie / eclair	3	160–170 ¹	3	190–210	0:15–0:30
Swiss roll	3	150–170 ¹	3	180–200 ¹	0:10–0:20
Fruit cake with shortcrust pastry ¹	3	160–170	3	170–190	0:40–1:20

Operating mode	3D hot air		Conventional Heat		Baking time For both types of baking, in hrs, mins.
	Shelf level	Temp. in °C	Shelf level	Temp. in °C	
Slices with topping/ filling, e.g. quark, cream, sugar, almonds	–	–	3	160–180 ¹	0:40–1:20
Pizza (thick base) ²	1	180–200	1	190–210 ¹	0:30–1:00
Pizza (thin base)	1	200–220	1	230 ¹	0:10–0:25
Unleavened bread	1	200–220	1	230 ¹	0:08–0:15
Wähe (Swiss flan)	1	180–200	1	210–230	0:35–0:50
Biscuits					
Shortcrust biscuits	3	150–160	3	170–190 ¹	0:06–0:20
Iced biscuits	3	140–150	3	160–180	0:10–0:40
Cake mixture biscuits	3	150–160	3	170–190	0:15–0:20
Cakes and pastries with egg white, meringues	3	80–100	3	100–120	2:00–2:30
Macaroons	3	100–120	3	120–140	0:30–0:60
Yeast dough biscuits	3	160–170	3	170–190	0:20–0:40
Puff pastry cakes and pastries	3	160–170 –180 ¹	3	190–210 ¹	0:20–0:30
Bread rolls	3	180–200 ¹	3	180–220 ¹	0:20–0:35

1) Preheat oven!

2) Use deep pan!

Always count shelf levels from the bottom up!

Baking table

Baking on more than one shelf level

Recipe	3D hot air		Baking time in hrs, mins.
	Shelf level	Temp. in °C	
Cakes /cakes and pastries on baking sheet		160–180¹	
Pie / eclair	2/4	140–160	0:35–0:60
Dry sponge cake with crumble topping	2/4		0:30–0:60
Biscuits		150–160	
Shortcrust biscuits	2/4	140–150	0:15–0:35
Iced biscuits	2/4	160–170	0:20–0:60
Cake mixture biscuits	2/4	80–100	0:25–0:40
Cakes and pastries with egg white, meringues	2/4	100–120	2:10–2:50
Macaroons	2/4	160–170	0:40–1:20
Yeast dough cookies	2/4	170–180 ¹	0:30–0:60
Puff pastry cakes and pastries	2/4	180–190 ¹	0:30–0:50
Bread rolls	2/4		0:30–0:55

Always count shelf levels from the bottom up!

Table for strudel and baked dishes

	Conventional heat		Baking time in hrs, mins.
	Shelf level	Temp. in °C	
Baked pasta	1	180–200	0:45–1:00
Lasagne	1	180–200	0:25–0:40
Baked vegetables ¹	1	200–220	0:15–0:30
Pizza baguette ¹	1	200–220	0:15–0:30
Soufflé	1	180–200	0:15–0:30
Fish pie	1	180–200	0:30–1:00
Stuffed vegetables	1	180–200	0:30–1:00

1) Preheat oven!

Always count shelf levels from the bottom up!

Baking tables for frozen ready-made dishes

Dish	Shelf level	Oven function	Temperature	Time
Frozen pizza	3	Conventional heat	Follow instructions on pack.	Follow instructions on pack.
Baguettes	3	Conventional heat	Follow instructions on pack.	Follow instructions on pack.
Fruit cake base	3	Conventional heat	Follow instructions on pack.	Follow instructions on pack.
Chips	3	Convection heat	200–220°C	15–25 mins.

Always count shelf levels from the bottom up!

NB: Turn chips 2 or 3 times when heating.

When heating frozen dishes, the baking tray may bend out of shape because of the great difference in the temperature of the frozen food and the oven.



Trays normally return to their original shape once they have cooled down.

Baking table

Baking tips

Results of baking	Possible cause	Solution ¹¹
The cake base is too light	Wrong shelf level	Use a dark baking tin or put the cake one level lower down.
Cake collapses (turns lumpy, soggy)	Oven temperature too high	Set the temperature slightly lower.
	Baking time too short	Set a longer baking time. The baking time cannot be reduced by setting a higher temperature.
	Mixture contains too much liquid	Use less liquid. Follow instructions for dough mixing times, especially when using kitchen appliances.
Cakes are too dry	Oven temperature too low	Next time set a slightly higher temperature.
	Baking time too long	Set a slightly shorter baking time.
Cakes are browned unevenly	Baking temperature too high and baking time too short	Set a slightly lower baking temperature and a slightly higher baking time.
	Mixture unevenly distributed	Distribute the mixture evenly over the baking tray/tin.
	Fat filter in place	Remove the fat filter.
Baking time too long	Temperature too low	Next time set a slightly higher temperature.
	Fat filter in place	Remove the fat filter.

Roasting

When roasting, use the convection grilling (), conventional heat () modes.

TIP:

- Use the fat filter when roasting. The fan at the back wall of the oven is kept protected from fat splashes.
- Use heat resistant dishes when roasting (follow manufacturer's instructions).
- Stainless steel roasting pans are only of limited use, as they reflect the heat to a very large extent.
- When using dishes with plastic handles, ensure that the handles are heat resistant (follow manufacturer's instructions).
- Large items for roasting or a number of items can be placed directly on the deep pan or on the shelf above the deep pan (e.g. turkey, goose, 3~4 chickens, 3~4 knuckles of veal).
- Lean meat should be roasted in a roasting tray **with a lid** (e.g. veal, braised beef, deep frozen meat). This keeps the juices in the meat.
- For cooking crispy crusts or bacon, a casserole **with no lid** should be used (e.g. pork, minced meat, lamb, mutton, duck, knuckle of veal, chicken, poultry meat, roast beef, fillet of beef, game birds).

TIP:

- Clean the oven as soon as possible after use if you are roasting in an open-topped tin. It is easier to remove fat splashes when the oven is still warm.

WARNING

Allow the oven to cool down enough to ensure there is no risk of burning yourself.

Roasting table

The table contains the required temperatures, roasting times and shelf levels for various kinds of meat. The figures stated are approximate figures only.

- We recommend cooking meat and fish weighing over 1 kg in the oven.
- For lean meat and fish, use conventional heat. For all other kinds of meat we recommend convection grilling() mode.
- Add a little liquid to prevent roasting juices or fat from getting burned on.
- Turn the joint over after about half or two thirds of the cooking time.

TIP:For better roasting results, baste joints and poultry with their own juices a number of times during the roasting process.

Switch off the oven 10 minutes before the end of cooking time. Make use of the residual heat available.

Operating mode		Conventional heat		Convection grilling		Cooking time in hrs, mins.
Type of meat	Weight, size	Shelf level	Temp. in °C	Shelf level	Temp. in °C	
Beef						
Pot roast	1–1.5 kg	2	200–230	–	–	2:00–2:30
Roast beef or fillet of beef						
– rare	2.5cm thick	2	230 ¹	2	190–200	0:05–0:06
– pink	2.5cm thick	2	230 ¹	2	180–190	0:06–0:08
– well done	2.5cm thick	2	210–230 ¹	2	170–180	0:08–0:10
Pork						
Shoulder, neck, ham	1–1.5 kg	2	210–220	2	160–180	1:30–2:00
Chop, loin	1–1.5 kg	2	180–190	2	170–180	1:00–1:30
Pork roast	750 g–1 kg	2	170–180	2	160–170	0:45–1:00
Knuckle of pork (pre-cooked)	750 g–1 kg	2	210–220	2	150–170	1:30–2:00

Operating mode		Conventional heat		Convection grilling		Cooking time
Type of meat	Weight, size	Shelf level	Temp. in °C	Shelf level	Temp. in °C	in hrs, mins.
Veal						
Veal roast	1 kg	2	210–220	2	160–180	1:30–2:00
Knuckle of veal	1.5–2 kg	2	210–225	2	160–180	2:00–2:30
Lamb						
Leg of lamb Lamb roast	1–1.5 kg	2	210–220	2	150–170	1:15–2:00
Saddle of lamb	1–1.5 kg	2	210–220	2	160–180	1:00–1:30
Game						
Roast hare, leg of hare	Up to 1 kg	3	220–230 ¹	3	160–170	0:25–0:40
Venison (saddle)	1.5–2 kg	2	210–220	2	160–180	1:15–1:45
Venison (leg, haunch)	1.5–2 kg	2	200–210	2	160–180	1:30–2:15
Poultry						
Poultry portions (4–6 pieces)	200–250 g each	3	220–230	3	180–200	0:35–0:50
Chicken halves (2–4 parts)	400–500 g each	3	220–230	3	180–200	0:35–0:50
Chicken, poularde	1–1.5 kg	2	220–230	2	170–180	0:45–1:15
Duck	1.5–2 kg	2	210–220	2	160–180	1:00–1:30
Goose	3.5–5 kg	2	200–210	2	150–160	2:30–3:00
Turkey	2.5–3.5 kg 4–6 kg	2	200–210 180–200	2	150–160 140–150	1:30–2:00 2:30–4:00

1) Preheat oven!

Always count the shelf levels from the bottom up!

Grilling

For grilling, you have a choice of 3 different operating modes.

Large grill

For larger quantities of flat food for grilling, for top-baking in large tins. Choose 1 of 3 power levels (1 low, 2 medium and 3 high), as suitable for the food being grilled.

Small grill

For smaller quantities of flat food for grilling, for top-baking in small tins. Choose 1 of 3 power levels (1 low, 2 medium and 3 high), as suitable for the food being grilled.

Convection grilling

For grilling large pieces of meat or poultry, such as rolled roast or turkey, for example.

NB: When grilling, the oven door must be kept closed at all times. As a basic principle, the oven should be preheated for 3 minutes!

Grilling dishes

Use the grill grid or the deep pan for grilling. Use the shelf for making toast. To catch dripping liquids, slide the baking tray or deep pan in at Level 1 or 2.

Shelf levels

Use Levels 4 or 5 for grilling flat pieces of meat. Warning note: exposed parts of the oven can become hot during grilling. Keep children at a distance. (Insert with corresponding programme, as appropriate.)

Using the grilling table

The grilling times are intended as approximate values only. The actual times may vary depending on the quality of the actual meat or fish.

Grilling is particularly suitable for cooking flat pieces of meat and fish.

Turn the grilled food over about halfway through the cooking time.

Grilling table

Food for grilling	Shelf level	Grilling time	
		1st side	2nd side
Rissoles	4	8–10 mins.	6–8 mins.
Pork fillet	4	10–12 mins.	6–10 mins.
Grilling sausages	4	8–10 mins.	6–8 mins.
Beef or veal steaks	4	6–7 mins.	5–6 mins.
Fillet of beef (1 kg approx.)	3	10–12 mins.	10–12 mins.
Toast ¹	3	2–3 mins.	2–3 mins.
Toast with topping	3	6–8 mins.	–

1) Shelf or deep pan

Always count the shelf levels from the bottom up!

Defrosting

Use the "Defrosting()" operating mode to defrost food.

Defrosting dishes

- Remove the dish from its packaging, put it on a plate and place the plate on the shelf.
- Do not cover the dish with a plate or bowl, as this can considerably extend the defrosting time.
- Do not use the liquid produced during defrosting for cooking the dish to avoid the risk of salmonella. Ensure that the liquid produced during defrosting is free to run off the food.

Shelf levels

- For defrosting, use the shelf on Level 1, or Level 2 for larger dishes.

Defrosting table

The following table contains reference values for defrosting.

Dish	Defrosting time (mins.)	Time for heating up (mins.)	Comments
Chicken, 1000 g	100–140	20–30	Use the shelf with the deep pan. Turn the chicken after half of the time or cover with tin foil.
Meat, 1000 g	100–140	20–30	Turn the meat after half of the time or cover with tin foil.
Meat, 500 g	90–120	20–30	Turn the meat after half of the time or cover with tin foil.
Trout, 150 g	23–35	10–15	Do not cover.
Strawberries, 300 g	20–30	10–20	Do not cover.

Special functions

You can set your oven to low temperatures from 40°C and up. This allows you to make yoghurt, for example, or to let dough rise.

Yoghurt making

Dishes

Glasses or cups of 150 ml capacity which you cover with a lid or a piece of tin foil.

Shelf level

Place the shelf on Level 3.

Preparation

1. Heat 1 litre of milk to 60–70°C.
2. Leave the milk to cool to roughly 40°C.
3. Stir 150g of natural yoghurt into the milk, and then pour the mixture into the individual containers and cover.
4. Leave the individual containers on the shelf for approx. 5–8 hours (until the yoghurt has reached a set consistency), mature in the oven with Conventional heat elements set at 40°C.

Letting dough rise

Dishes

Use a heat-resistant bowl for the dough (40°C).

Shelf level

Place the shelf on Level 2.

Preparation

1. Put the dough in the bowl. Cover the bowl with a damp cloth and place on the shelf.
2. Switch on conventional heat() mode at 40°C.
3. Leave the dough to rise until it has doubled in size.

Test dishes as per 44547

	Food	Oven level	Oven function	Temperature	Time (mins)
Baking	Pastry Stripes	2	Conventional heat	160-180°C	24-28
		2	3D hot air	140-160°C	38-42
		2+4	3D hot air	140-160°C	40-46
	Small Cakes	3	Conventional Heat	170-180°C	25-28
		2	3D hot air	150-170°C	37-42
		2+4	3D hot air	150-170°C	35-40
	Flat Cake	3	Conventional Heat	170-180°C	32-36
		2	3D hot air	150-170°C	45-50
		2+4	3D hot air	150-170°C	50-60
	Fatless Sponge Cake	1	Conventional Heat	170-190°C	32-36
		1	3D hot air	160-180°C	35-40
	Yeast Tray Cake	3	Conventional Heat	170-190°C	75-80
		2	3D hot air	150-170°C	70-75
		2+4	3D hot air	150-170°C	70-75

	Food	Oven level	Oven function	Temperature	Time (mins)	Instructions
Roasting	Pork Roast	1	Convection Grill	180-200°C	180-200	For the best result, turn food over after 80% of cooking time.
	Whole Chicken	2	Convection Grill	190-200°C	80-90	Place chicken on wire grill with breast side up. Insert deep pan into oven level 1 for dripping. For the best result, turn food over after 80% of cooking time.

	Food	Oven level	Oven function	Preheating (mins)	Time (min:sec)	Instructions
Grilling	Toast	4	Large grill step 3	4	1:30-2:00	
	Beef Burgers	4	Large grill step 3	4	12:00-15:00	Turn food over after 70% of cooking time.

Cleaning and care

Warning:

Switch the oven off before cleaning and allow to cool.

Outside

Wipe the front of the appliance with a soft cloth using a mild detergent.

- Do not use any caustic or abrasive cleaning materials.
- For aluminium front panels use a mild window cleaner and for stainless steel front panels use the corresponding cleaner for stainless steel.

Oven interior

NB!

Clean the appliance after use, as soon as it has cooled down. This makes it easier to remove any deposits and they cannot get burnt on.

- Switch the oven light on.
- Wipe down the oven with water and dishwashing liquid. Allow to dry. Do not use any abrasive cleaners.
- Remove persistent deposits with a special oven cleaning product.

Important: When using a spray-on cleaner, it is essential to follow the manufacturer's instructions!

Do not clean the door seal by hand.

Accessories

Clean the accessories (shelves, baking trays, shelf supports, etc.) after use and allow to dry fully. If necessary, treat in advance to soften deposits.

Cleaning and care

Shelf supports

The shelf supports on the left and right-hand side walls of the oven can be removed for cleaning.

Detaching side runners

1. Remove the screw holding each of the shelf supports in place.

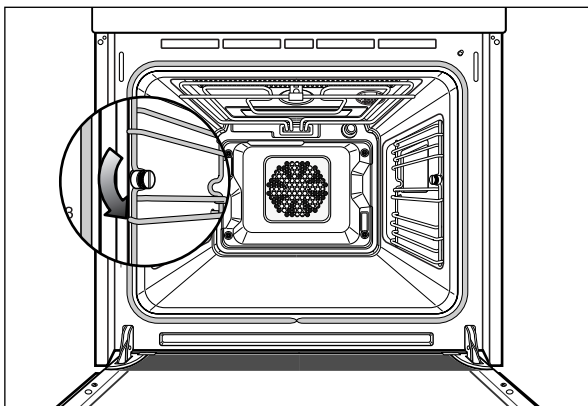

2. Take out the shelf supports.

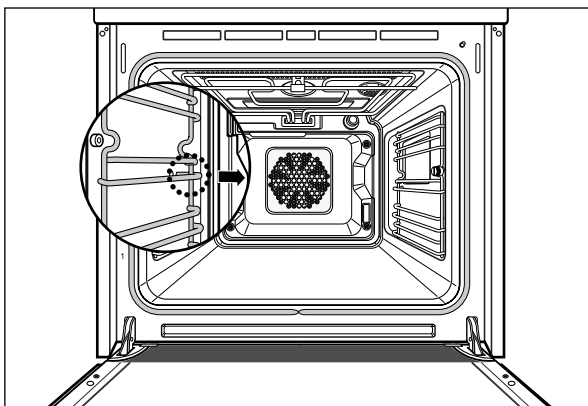

To replace, proceed as follows:

1. Put the inserting bar of the shelf support into the hole.

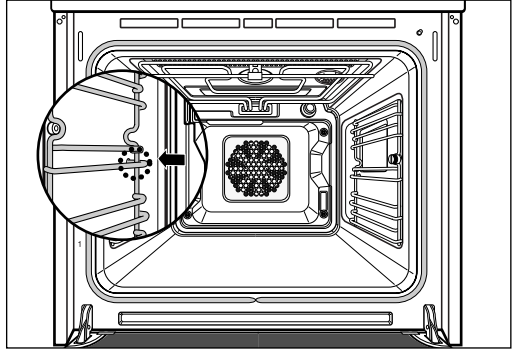

2. Slip the recesses in the shelf supports over the screw heads. Tighten the screws fully.

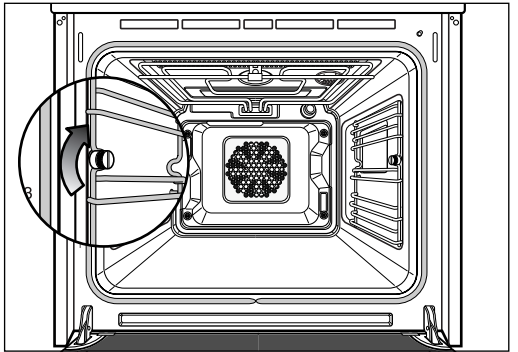

Fat filter

Allow the oven to cool completely before removing the fat filter.

The fat filter is attached to the fan guard.

To remove, simply lift and pull out.

1. Clean the fat filter with hot water and dishwashing liquid or in the dishwasher.
2. To remove stubborn burnt-on deposits, the fat filter can be placed in hot water with 2-3 dessertspoons of dishwashing liquid added to soften deposits.

Oven Light

Risk of electric shock!

The oven lamps sockets are live:

- Switch the oven off before replacing lamps.

To protect the lamps and glass covers, a soft cloth should be placed on the oven floor.

Replacing the oven light

1. Unscrew the lamp cover by turning anti-clockwise.
2. Replace the lamp (Type E14, 230V, 25 Watts, heatproof to 300°C)

- * Receive the lamp with the customer service or with the specialized trade.

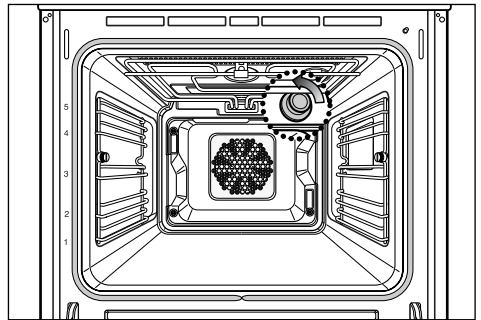

Oven Door

The oven door can be removed for cleaning.

Removing the oven door

1. Open the oven door fully.
Insert the locking pins into the openings on both hinges (locking pins included with accessories).

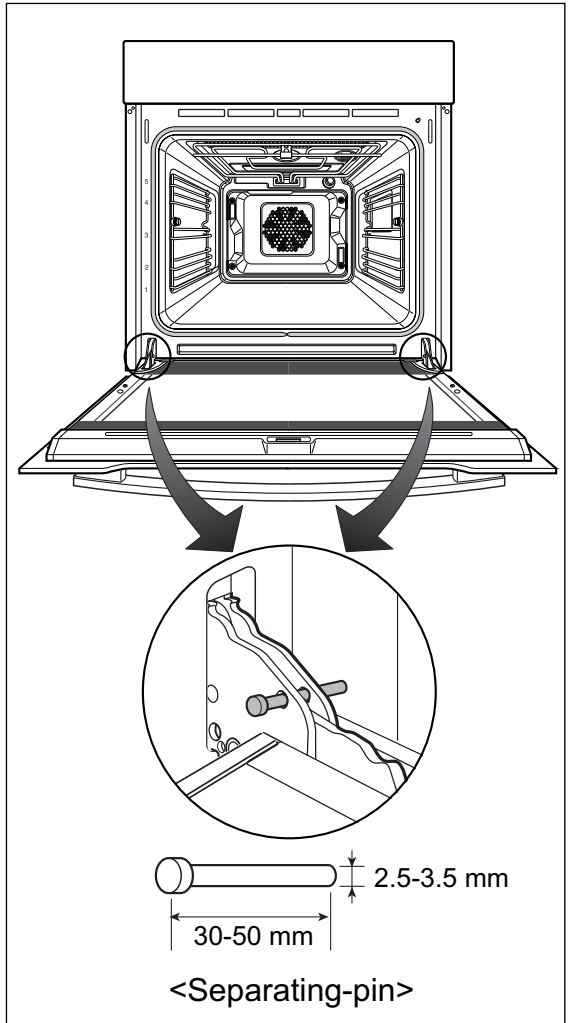

Oven Door

2. Grip the oven door at the middle of the two sides.

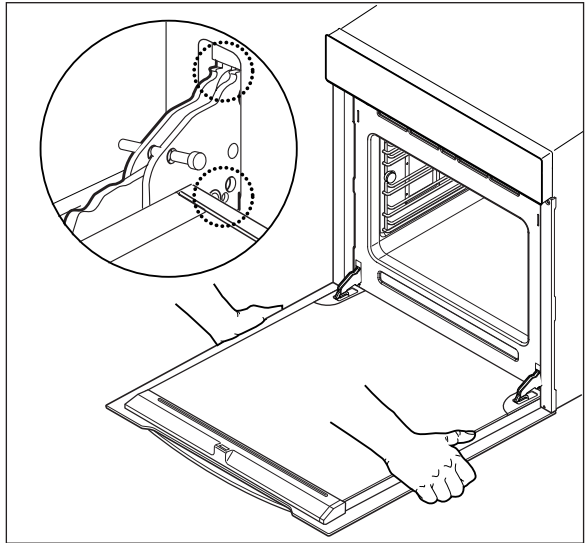

3. Turn the door roughly 15 degrees upwards and lift the area of the hinges by roughly 2 mm vertically.

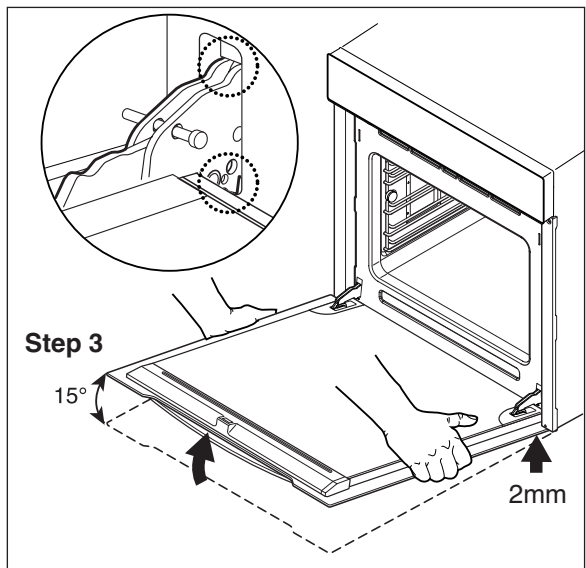

4. Now turn the door through roughly 80 degrees until the hinges are completely out of the openings. Place the door with its outside down on a soft, smooth surface, e.g. a blanket, in order to avoid any scratching.

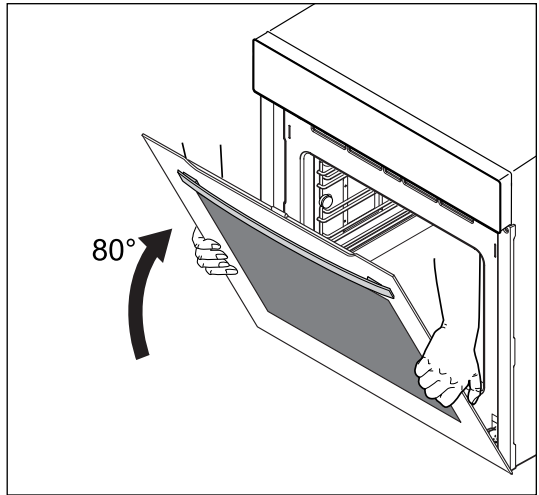

Warning:

For reasons of safety, the locking pins must not be removed from the door hinges when the door is off.

Tip:

If the locking pins have gone missing, you can use a suitable metal rod or a nail.

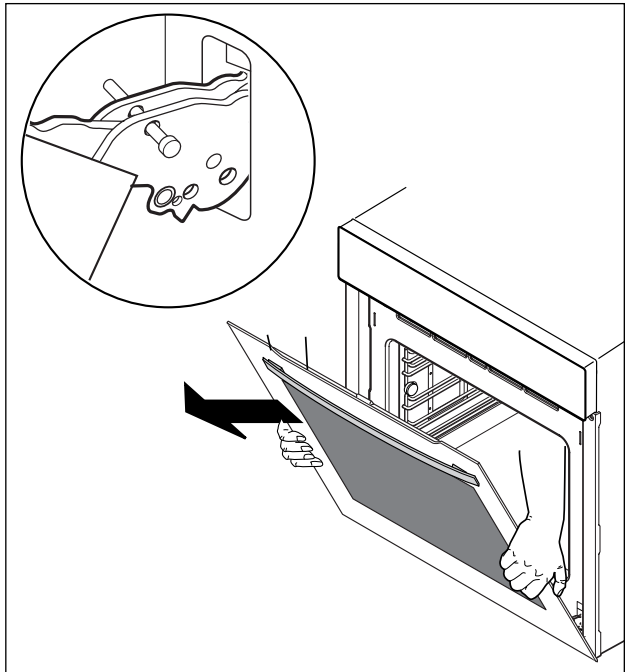

Oven Door

Rehanging the oven door

The locking pins must be in place in the hinges.

1. Grip the door with both hands, placing each in the middle at the sides.
2. Position the door hinges until they are fully seated in the hinge openings. 1
3. Turn the door on the horizontal plane and remove the locking pins from the hinges. 2
4. Close the oven door.

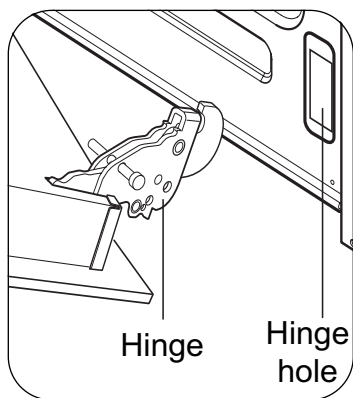
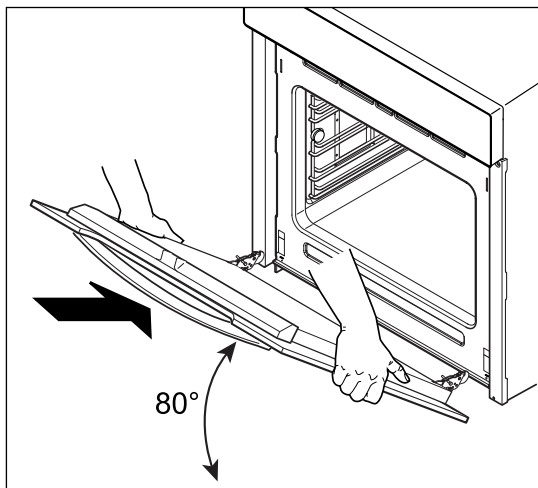

- * Do not remove the separating pins until the door has been placed back into its position securely.

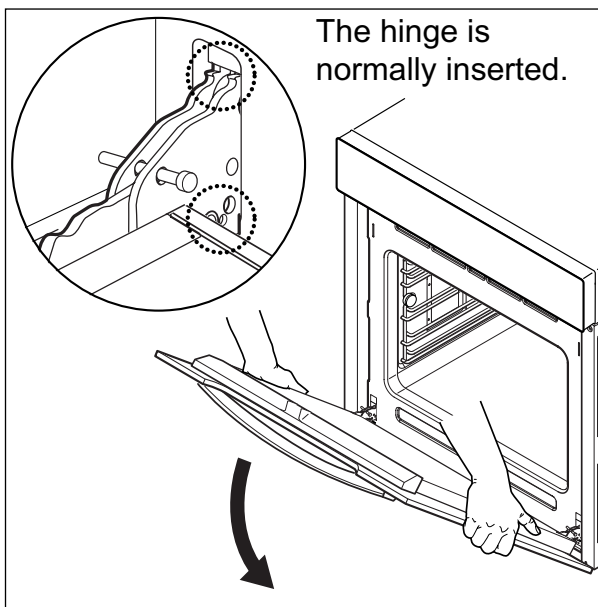

Oven Door

3. The innermost glass door panel can now be removed.

Door bracket

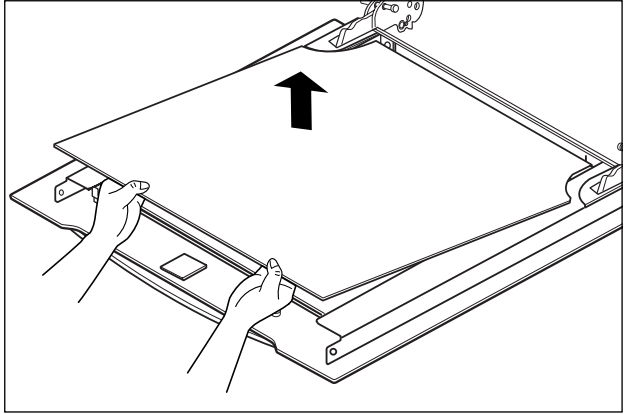
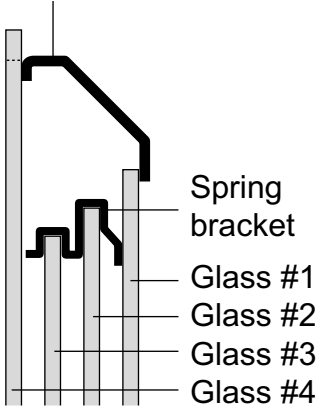

Note: Clean the glasses with warm water or washing-up liquid and polish dry with a soft clean cloth.

4. Remove the two spring-loaded catches from panels 2 and 3.

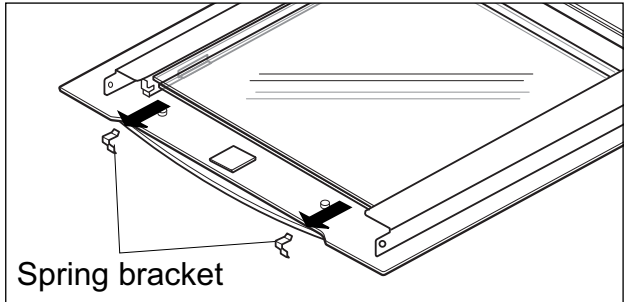

5. Panels 2 and 3 can now be removed.

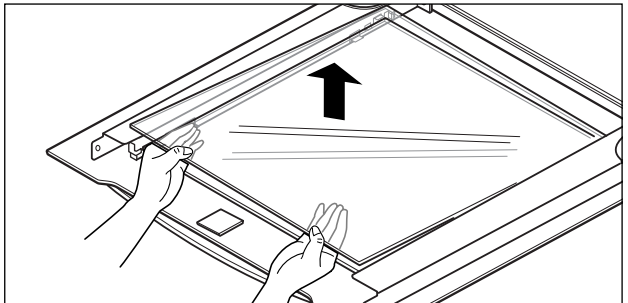

Cleaning the glass panels

Clean the glass panels with a mild detergent. Do not use any abrasive material or pan cleaner.

Replacing the glass panels

1. Replace both glass panels. Relocate the spring-loaded catches between panels 3 and panel 2.

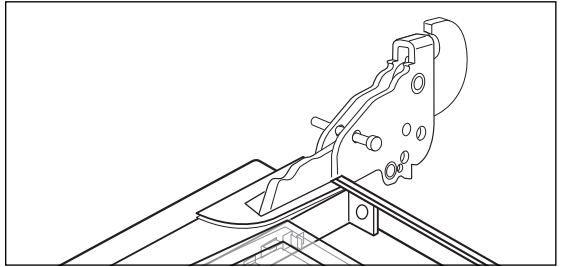

2. Place the insulator in its proper position and screw on the door handle, tightening down at both sides.

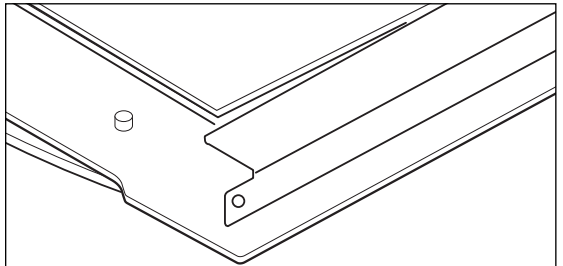

3. Replace panel 2, the top metal cover and the plastic side brackets. When reassembling the door, ensure that the middle section is correctly inserted in the recess provided.

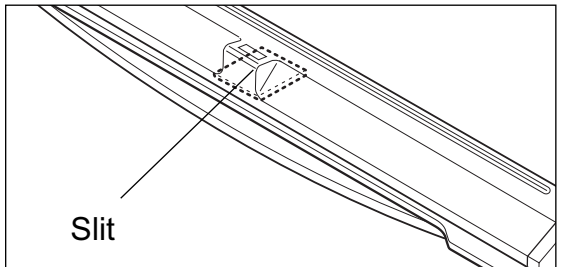

4. Secure the plastic brackets by screwing onto the door.

Troubleshooting

Fault	Possible cause	Solution
Oven does not heat up.	Oven not switched on.	Switch oven on.
	Clock not set.	Set clock (refer to section "Before initial use").
	The necessary settings have not been selected.	Check settings.
	Fault in the mains power supply. The protective electrical system or the fuses have been tripped.	Check out fuses and the protective system. If the fault recurs, consult a qualified electrician.
Oven does not heat up even after function and temperature are set.	An automatic programme has been activated, to be started at a later point in time.	Cancel the automatic programme or reset it.
The Service symbol is displayed along with an error code.	Fault in the electronic system.	Contact your local Customer Service Centre.
Time display in the electronic clock flashes.	There has been a power failure.	Reset the clock (refer to section "Before initial use").
Oven light not working.	Bulb is faulty.	Replace the bulb (refer to section "Cleaning and care").

If the fault cannot be rectified by the above measures, contact your local Customer Service Centre.

NB! If faulty, the appliance must not be used. If a fault occurs, the appliance must be isolated by removing the mains plug or switched off by removing the fuse.

The appliance must only be repaired by **a specially trained and qualified electrical professional only**. Repairs carried out improperly may result in considerable damage.

In the event of a fault, the repair carried out by a Customer Service technician or the specialist dealer may be subject to charges, even during the guarantee period.

Error codes

Error Code	Possible Cause	Solution
F-1	Sensor(Thermistor) is short.	Call your local LG service center.
F-2	Sensor(Thermistor) is open. The door will be locked as if the oven is in self-cleaning mode.	Call your local LG service center.
F-3	Door Locking system is in troubled. (For self cleaning model only) Oven temperature is too high abnormally. (For non self cleaning model only)	Shut off the power supply and reconnect the power(after about 10 seconds) again. If the door is unlocked, you can use the oven except for self cleaning mode. Call your local LG service center.

CAUTION

- **Repairs to the appliance must be carried out by a specially licensed technician only! Considerable danger may result from incorrect repairs.**
- **Do not use the appliance if damaged. In the event of a fault or failure, switch off at the mains. In the event of a fault, visits by technicians from Customer Service or dealers may not be covered by the warranty, if the cause of failure is the result of abnormal customer use.**

Technical specifications

Mains connection 220–240 V ~ 50 Hz

MAX power consumption 3500 Watts

Oven interior dimensions

Height x width x depth 30.0 x 42.4 x 41.6 cm

Volume (useful capacity) 55 L

Output Power 3500W

Installation instructions

Important: installation should be undertaken by a qualified professional electrician only.

The oven must be installed in compliance with the manufacturer's instructions.

Safety instructions for the installer

- During installation, ensure that no persons can come into contact with live components.
- The housing in which the oven is installed must comply with the stability requirements of the DIN 68930 standard.
- The oven must be installed by a qualified professional electrician, in accordance with the corresponding regulations and standards.
- The oven is a heavy appliance and must be transported with great care.
- Before initial use, remove all packaging, both external and from inside the appliance.
- No modification may be made to the oven's technical characteristics.
- The integrated cooking area or hotplates is/are provided with special connections. These may only be attached to the appropriate corresponding connections of the same type.

Customer service & spare parts

If you require spare parts or a technician, contact your local LG Customer Service Centre.

Your call will be automatically passed on to the Customer Service Centre responsible for your post code area. You can find the address of your local Customer Service Centre

Please ensure you have the following details to hand:

1. Your name and address, including your post code.
2. Your telephone number.
3. Exact details of the nature of the problem.
4. The model, series and production number. These details are found on the rating plate located at the right-hand inner edge of the oven door.
5. Your dated receipt of purchase. Please note that proof of purchase is required for any warranty claim. Before submitting a warranty claim, please ensure that you have read through the section on "Troubleshooting". There will be a charge for any inspection carried out by a technician if it should transpire that there is no mechanical or electrical fault present in the appliance.

Customer Service

For general queries on LG appliances or further details of LG products, please contact our Customer Service Centre.

Memo



Memo



Memo



Memo





FOR CUSTOMER SERVICE PLEASE CONTACT LG Service on
1300 LG CARE (1300 54 2273) AUSTRALIA or
0800 LG CARE (0800 54 2273) NEW ZEALAND

www.lg.com

LG Electronics Australia 2 Wonderland Drive Eastern Creek NSW 2766 (ABN : 98 064 531 264)

Printed in korea