



LG

Life's Good

OWNER'S MANUAL

LED TV

* LG LED TV applies LCD screen with LED backlights.

Please read this manual carefully before operating your set and retain it for future reference.

| | | | | |
|----------|----------|----------|----------|----------|
| 32LN5700 | 32LN570B | 47LN5710 | 47LN5750 | 47LN5790 |
| 39LN5700 | | 50LN5710 | 50LN5750 | 55LN5790 |
| 42LN5700 | | 55LN5710 | 55LN5750 | |
| 47LN5700 | | 60LN5710 | 60LN5750 | |
| 50LN5700 | | | | |
| 55LN5700 | | | | |
| 60LN5700 | | | | |

IMPORTANT SAFETY INSTRUCTIONS

Always comply with the following precautions to avoid dangerous situations and ensure peak performance of your product.



TO REDUCE THE RISK OF ELECTRIC SHOCK DO NOT REMOVE COVER (OR BACK). NO USER SERVICEABLE PARTS INSIDE. REFER TO QUALIFIED SERVICE PERSONNEL.

 The lightning flash with arrowhead symbol, within an equilateral triangle, is intended to alert the user to the presence of uninsulated "dangerous voltage" within the product's enclosure that may be of sufficient magnitude to constitute a risk of electric shock to persons.

 The exclamation point within an equilateral triangle is intended to alert the user to the presence of important operating and maintenance (servicing) instructions in the literature accompanying the appliance.

WARNING/CAUTION

- TO REDUCE THE RISK OF FIRE AND ELECTRIC SHOCK, DO NOT EXPOSE THIS PRODUCT TO RAIN OR MOISTURE.

WARNING

If you ignore the warning message, you may be seriously injured or there is a possibility of accident or death.

CAUTION

If you ignore the caution message, you may be slightly injured or the product may be damaged.

NOTE

The note helps you understand and use the product safely. Please read the note carefully before using the product.

Read these instructions.
Keep these instructions.
Heed all warnings.
Follow all instructions.



- Do not use this apparatus near water.



- Clean only with a dry cloth.



- Do not block any ventilation openings. Install in accordance with the manufacturer's instructions.



- Do not install near any heat sources such as radiators, heat registers, stoves, or other apparatus (including amplifiers) that produce heat.



- Do not defeat the safety purpose of the polarized or grounding-type plug. A polarized plug has two blades with one wider than the other. A grounding type plug has two blades and a third grounding prong. The wide blade or the third prong are provided for your safety. If the provided plug does not fit into your outlet, consult an electrician for replacement of the obsolete outlet (Can differ by country).



- Do not press strongly upon the panel with a hand or a sharp object such as a nail, pencil or pen, or make a scratch on it.



- Protect the power cord from being walked on or pinched particularly at plugs, convenience receptacles, and the point where they exit from the apparatus.



- Only use attachments/accessories specified by the manufacturer.



- Use only with a cart, stand, tripod, bracket, or table specified by the manufacturer, or sold with the apparatus. When a cart is used, use caution when moving the cart/apparatus combination to avoid injury from tip-over.



S3125A

- Unplug this apparatus during lightning storms or when unused for long periods of time.



- Refer all servicing to qualified service personnel. Servicing is required when the apparatus has been damaged in any way, such as power-supply cord or plug is damaged, liquid has been spilled or objects have fallen into the apparatus, the apparatus has been exposed to rain or moisture, does not operate normally, or has been dropped.



- Do not stick metal objects or any other conductive material into the power cord. Do not touch the end of the power cord while it is plugged in.
- Keep the packing anti-moisture material or vinyl packing out of the reach of children. Anti-moisture material is harmful if swallowed. If swallowed by mistake, force the patient to vomit and visit the nearest hospital. Additionally, vinyl packing can cause suffocation. Keep it out of the reach of children.

- CAUTION concerning the Power Cord (Can differ by country):

It is recommended that appliances be placed upon a dedicated circuit; that is, a single outlet circuit which powers only that appliance and has no additional outlets or branch circuits. Check the specification page of this owner's manual to be certain. Do not connect too many appliances to the same AC power outlet as this could result in fire or electric shock. Do not overload wall outlets. Overloaded wall outlets, loose or damaged wall outlets, extension cords, frayed power cords, or damaged or cracked wire insulation are dangerous. Any of these conditions could result in electric shock or fire. Periodically examine the cord of your appliance, and if its appearance indicates damage or deterioration, unplug it, discontinue use of the appliance, and have the cord replaced with an exact replacement part by an authorized service. Protect the power cord from physical or mechanical abuse, such as being twisted, kinked, pinched, closed in a door, or walked upon. Pay particular attention to plugs, wall outlets, and the point where the cord exits the appliance. Do not move the TV with the power cord plugged in. Do not use a damaged or loose power cord. Be sure to grasp the plug when unplugging the power cord. Do not pull on the power cord to unplug the TV.



- **Warning** - To reduce the risk of fire or electrical shock, do not expose this product to rain, moisture or other liquids. Do not touch the TV with wet hands. Do not install this product near flammable objects such as gasoline or candles, or expose the TV to direct air conditioning.



- Do not expose to dripping or splashing and do not place objects filled with liquids, such as vases, cups, etc. on or over the apparatus (e.g. on shelves above the unit).



- **Grounding**

(Except for devices which are not grounded.)

Ensure that you connect the earth ground wire to prevent possible electric shock (i.e. a TV with a three-prong grounded AC plug must be connected to a three-prong grounded AC outlet). If grounding methods are not possible, have a qualified electrician install a separate circuit breaker. Do not try to ground the unit by connecting it to telephone wires, lightening rods, or gas pipes.

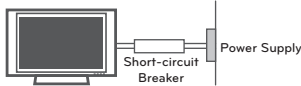

- As long as this unit is connected to the AC wall outlet, it is not disconnected from the AC power source even if the unit is turned off.
- Do not attempt to modify this product in any way without written authorization from LG Electronics. Unauthorized modification could void the user's authority to operate this product.

- **Outdoor Antenna Grounding**

(Can differ by country):

If an outdoor antenna is installed, follow the precautions below. An outdoor antenna system should not be located in the vicinity of overhead power lines or other electric light or power circuits, or where it can come in contact with such power lines or circuits as death or serious injury can occur. Be sure the antenna system is grounded so as to provide some protection against voltage surges and built-up static charges. Section 810 of the National Electrical Code (NEC) in the U.S.A. provides information with respect to proper grounding of the mast and supporting structure, grounding of the lead-in wire to an antenna discharge unit, size of grounding conductors, location of antenna discharge unit, connection to grounding electrodes and requirements for the grounding electrode.

Antenna grounding according to the National Electrical Code, ANSI/NFPA 70

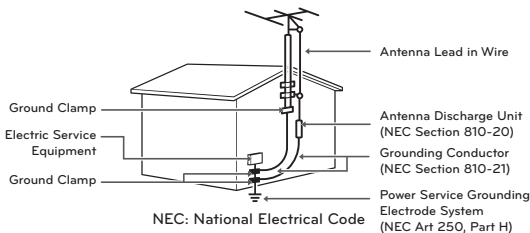

- **Cleaning**

When cleaning, unplug the power cord and wipe gently with a soft cloth to prevent scratching. Do not spray water or other liquids directly on the TV as electric shock may occur. Do not clean with chemicals such as alcohol, thinners or benzine.

- **Moving**

Make sure the product is turned off, unplugged and all cables have been removed. It may take 2 or more people to carry larger TVs. Do not press or put stress on the front panel of the TV.

- **Ventilation**

Install your TV where there is proper ventilation. Do not install in a confined space such as a bookcase. Do not cover the product with cloth or other materials while plugged. Do not install in excessively dusty places.

- If you smell smoke or other odors coming from the TV, unplug the power cord and contact an authorized service center.
- Keep the product away from direct sunlight.
- Never touch this apparatus or antenna during a thunder or lightning storm.
- When mounting a TV on the wall, make sure not to install the TV by hanging the power and signal cables on the back of the TV.
- Do not allow an impact shock or any objects to fall into the product, and do not drop anything onto the screen.
- **Disconnecting the Main Power**
The power outlet used with this device must remain easily accessible.
- Store the accessories (battery, etc.) in a safe location out of the reach of children.
- This apparatus use batteries. In your community there might be regulations that require you to dispose of these batteries properly due to environmental considerations. Please contact your local authorities for disposal or recycling information.
- Do not dispose of batteries in a fire.
- Do not short circuit, disassemble or allow the batteries to overheat.

• Dot Defect

The Plasma or LCD panel is a high technology product with resolution of two million to six million pixels. In a very few cases, you could see fine dots on the screen while you're viewing the TV. Those dots are deactivated pixels and do not affect the performance and reliability of the TV.

• Generated Sound

"Cracking" noise: A cracking noise that occurs when watching or turning off the TV is generated by plastic thermal contraction due to temperature and humidity. This noise is common for products where thermal deformation is required.

Electrical circuit humming/panel buzzing: A low level noise is generated from a high-speed switching circuit, which supplies a large amount of current to operate a product. It varies depending on the product.

This generated sound does not affect the performance and reliability of the product.

• Take care not to touch the ventilation openings.

When watching the TV for a long period, the ventilation openings may become hot. This does not affect the performance of the product or cause defects in the product.

• If the TV feels cold to the touch, there may be a small "flicker" when it is turned on. This is normal, there is nothing wrong with TV. Some minute dot defects may be visible on the screen, appearing as tiny red, green, or blue spots. However, they have no adverse effect on the TV's performance. Avoid touching the LCD screen or holding your finger(s) against it for long periods of time. Doing so may produce some temporary distortion effects on the screen.

Preventing "Image burn" or "Burn-in" on your TV screen

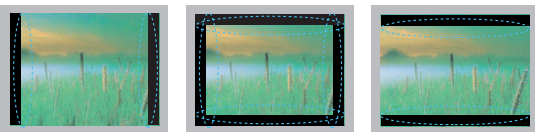

- If a fixed image displays on the TV screen for a long period of time, it will be imprinted and become a permanent disfigurement on the screen. This is "image burn" or "burn-in" and not covered by the warranty.
- If the aspect ratio of the TV is set to 4:3 for a long period of time, image burn may occur on the letterboxed area of the screen.
- Avoid displaying a fixed image on the TV screen for a long period of time (2 or more hours for LCD, 1 or more hours for the Plasma TV) to prevent image burn.

For USA and Canada

FCC NOTICE

This equipment has been tested and found to comply with the limits for a Class B digital device, pursuant to Part 15 of the FCC Rules. These limits are designed to provide reasonable protection against harmful interference in a residential installation. This equipment generates, uses and can radiate radio frequency energy and, if not installed and used in accordance with the instructions, may cause harmful interference to radio communications. However, there is no guarantee that interference will not occur in a particular installation. If this equipment does cause harmful interference to radio or television reception, which can be determined by turning the equipment off and on, the user is encouraged to try to correct the interference by one or more of the following measures:

- Reorient or relocate the receiving antenna.
- Increase the separation between the equipment and the receiver.
- Connect the equipment to an outlet on a circuit different from that to which the receiver is connected.
- Consult the dealer or an experienced radio/TV technician for help.

This device complies with part 15 of the FCC Rules. Operation is subject to the following two conditions: (1) this device may not cause harmful interference and (2) this device must accept any interference received, including interference that may cause undesired operation of the device.

Any changes or modifications in construction of this device which are not expressly approved by the party responsible for compliance could void the user's authority to operate the equipment.

NOTE TO CABLE/TV INSTALLER

This reminder is provided to call the CATV system installer's attention to Article 820-40 of the National Electric Code (U.S.A.). The code provides guidelines for proper grounding and, in particular, specifies that the cable ground shall be connected to the grounding system of the building, as close to the point of the cable entry as practical.

LICENSES

Supported licenses may differ by model. For more information about licenses, visit 'www.lg.com'.



Manufactured under license from Dolby Laboratories. "Dolby" and the double-D symbol are trademarks of Dolby Laboratories.



The terms HDMI and HDMI High-Definition Multimedia Interface, and the HDMI logo are trademarks or registered trademarks of HDMI Licensing LLC in the United States and other countries.



ABOUT DIVX VIDEO: DivX® is a digital video format created by DivX, LLC, a subsidiary of Rovi Corporation. This is an official DivX Certified® device that plays DivX video. Visit divx.com for more information and software tools to convert your files into DivX video.

ABOUT DIVX VIDEO-ON-DEMAND: This DivX Certified® device must be registered in order to play purchased DivX Video-on-Demand (VOD) movies. To obtain your registration code, locate the DivX VOD section in your device setup menu. Go to vod.divx.com for more information on how to complete your registration.

"DivX Certified® to play DivX® video up to HD 1080p, including premium content."

"DivX®, DivX Certified® and associated logos are trademarks of Rovi Corporation or its subsidiaries and are used under license."

"Covered by one or more of the following U.S. patents:
7,295,673; 7,460,668; 7,515,710; 7,519,274"



Manufactured under license under U.S. Patent Nos: 5,956,674; 5,974,380; 6,487,535 & other U.S. and worldwide patents issued & pending. DTS, the Symbol & DTS and the Symbol together are registered trademarks & DTS 2.0+Digital Out is a trademark of DTS, Inc. Product includes software. © DTS, Inc. All Rights Reserved.

OPEN SOURCE SOFTWARE NOTICE

To obtain the source code under GPL, LGPL, MPL and other open source licenses, that is contained in this product, please visit 'http://opensource.lge.com'.

In addition to the source code, all referred license terms, warranty disclaimers and copyright notices are available for download.

LG Electronics will also provide open source code to you on CD-ROM for a charge covering the cost of performing such distribution (such as the cost of media, shipping and handling) upon email request to 'opensource@lge.com'. This offer is valid for three (3) years from the date on which you purchased the product.

TABLE OF CONTENTS

2 IMPORTANT SAFETY INSTRUCTIONS

6 LICENSES

6 OPEN SOURCE SOFTWARE NOTICE

7 TABLE OF CONTENTS

8 INSTALLATION PROCEDURE

8 ASSEMBLING AND PREPARING

- 8 Unpacking
- 10 Optional Extras
- 11 Parts and Buttons
- 12 Lifting and moving the TV
- 13 Setting up the TV
 - 13 - Attaching the stand
 - 14 - Mounting on a table
 - 15 - Tidying cables
 - 16 - Mounting on a wall

17 MAKING CONNECTIONS

- 17 Connecting to an antenna or cable
- 18 Connecting to a HD receiver, DVD Player, or VCR
 - 18 - HDMI Connection
 - 19 - DVI to HDMI Connection
 - 20 - Connecting to a mobile phone
 - 21 - Component Connection
 - 22 - Composite Connection
- 23 Connecting to a PC
 - 23 - HDMI Connection or DVI to HDMI Connection
- 25 Connecting to an Audio System
 - 25 - Digital Optical Audio Connection
- 26 Connecting to a Sound Bar
 - 26 - Digital Optical Audio Connection
- 27 Connecting Headphones
- 27 Connecting a USB Drive

28 REMOTE CONTROL

30 MAGIC REMOTE CONTROL FUNCTIONS

- 31 Registering Magic Remote Control
- 31 How to use Magic Remote Control
- 31 Precautions to Take when Using the Magic Remote Control

32 WATCHING TV

- 32 Turning the TV on for the first time

33 USING THE USER GUIDE

34 SPECIFICATIONS

37 EXTERNAL CONTROL DEVICE SETUP

38 MAINTENANCE

- 38 Cleaning Your TV
 - 38 - Screen, frame, cabinet and stand
 - 38 - Power cord

38 TROUBLESHOOTING



NOTE

- Image shown may differ from your TV.
- Your TV's OSD (On Screen Display) may differ slightly from that shown in this manual.
- The available menus and options may differ from the input source or product model that you are using.
- New features may be added to this TV in the future.

INSTALLATION PROCEDURE

- 1 Open the package and make sure all the accessories are included.
- 2 Attach the stand to the TV set.
- 3 Connect an external device to the TV set.
- 4 Make sure the network connection is available.
You can use the TV network functions only when the network connection is made.

ASSEMBLING AND PREPARING

Unpacking

Check your product box for the following items. If there are any missing accessories, contact the local dealer where you purchased your product. The illustrations in this manual may differ from the actual product and item.

CAUTION

- Do not use any unapproved items to ensure the safety and product life span.
- Any damages or injuries by using unapproved items are not covered by the warranty.
- In case of some model, the thin film on screen is a part of TV, So don't take it off.

NOTE

- The items supplied with your product may vary depending on the model.
- Product specifications or contents of this manual may be changed without prior notice due to upgrade of product functions.
- For an optimal connection, HDMI cables and USB devices should have bezels less than 10 mm (0.39 inches) thick and 18 mm (0.7 inches) width.
- Use an extension cable that supports USB 2.0 if the USB cable or USB memory stick does not fit into your TV's USB port.

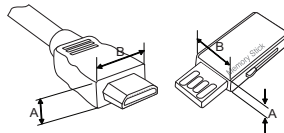

*A ≤ 10 mm (0.39 inches)

*B ≤ 18 mm (0.7 inches)

(For LN5700,
LN570B, LN5710, LN5790 series)

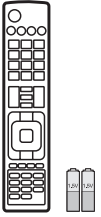

Remote Control, Batteries (AAA)
(See p. 28)

(For LN5750 series)

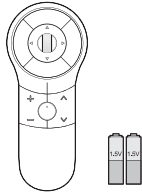

**Magic Remote Control,
Batteries (AA)**
(See p. 30)

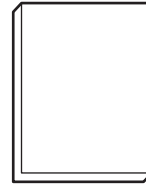

Owner's Manual

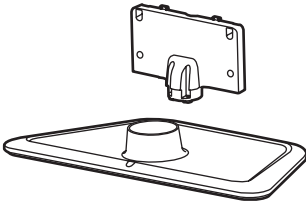

Stand Body , Stand Base
(See p. 13)



Power Cord

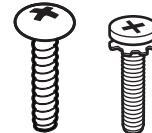

Stand Screws
3 EA, P5 x 25
4 EA, M4 x 14
(See p. 13)

(For 32/39/42/47/50/60LN5700,
32LN570B, 47/50/60LN5710,
47/50/60LN5750, 47LN5790)

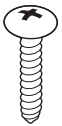

Desk-mount Screw
(See p. 14)



Cable Holder
(See p. 15)

(For LN5790 series)



Sound Bar
(See p. 26)

Optional Extras

Optional extras can be changed or modified for quality improvement without any notification.

Contact your dealer for buying these items.

These devices only work with certain models.

The model name or design may be changed due to the manufacturer's circumstances or policies.

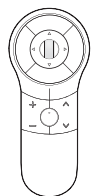

AN-MR400
Magic Remote

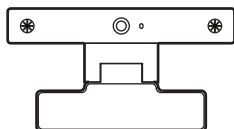

AN-VC4**
Video Call Camera

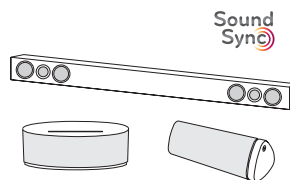

LG Audio Device



Tag On

(For LN5710, LN5790 series)



AN-WF100
Wireless LAN for Broadband/
DLNA Adaptor



AN-BL***
Wireless IR Blaster
(Depending on model)

Parts and Buttons

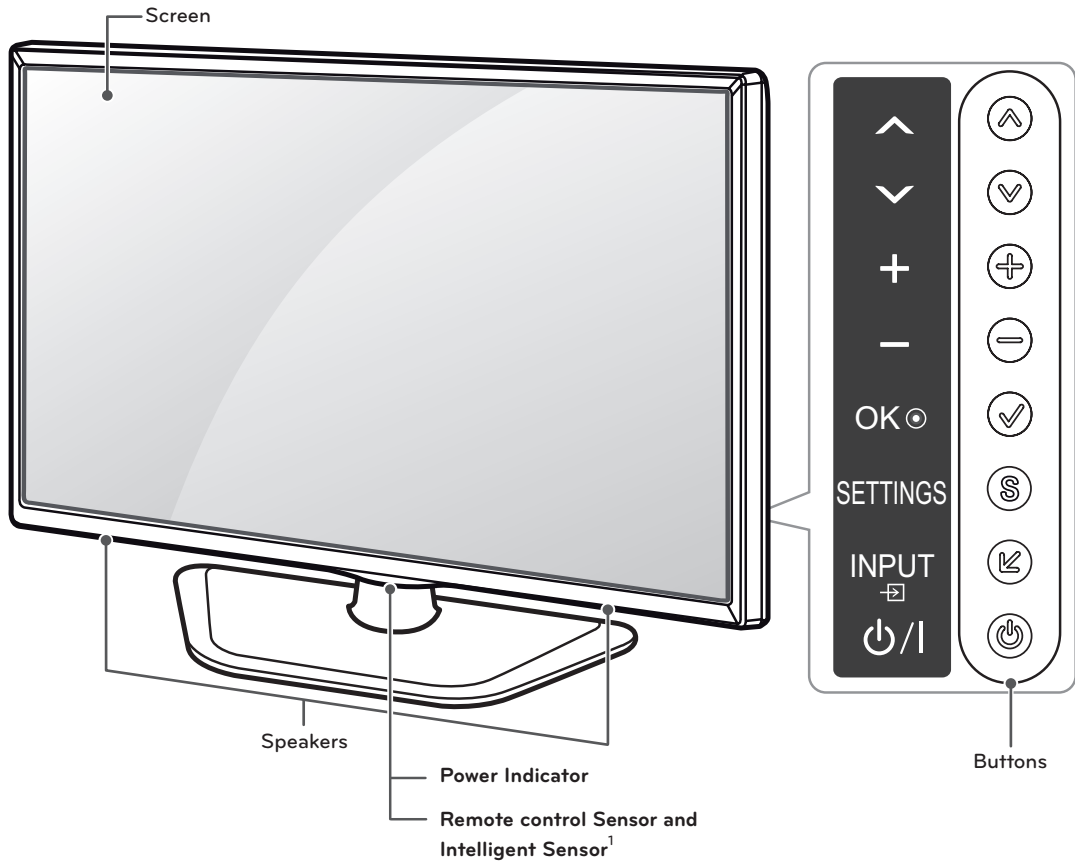

| Button | Description |
|---------------|-------------------------------------------------------------------|
| ▲ / ▼ (^ / v) | Scrolls through the saved channels. |
| + / - (+ / -) | Adjusts the volume level. |
| ✓ (OK ●) | Selects the highlighted menu option or confirms an input. |
| ⚙ (SETTINGS) | Accesses the main menus, or saves your input and exits the menus. |
| ↶ (INPUT ↶) | Changes the input source. |
| ⏻ (⏻ /) | Turns the power on or off. |

1 Intelligent sensor - Adjusts the image quality and brightness based on the surrounding environment.

Lifting and moving the TV

When moving or lifting the TV, read the following to prevent the TV from being scratched or damaged and for safe transportation regardless of its type and size.

CAUTION

- Avoid touching the screen at all times, as this may result in damage to the screen.
- It is recommended to move the TV in the box or packing material that the TV originally came in.
- Before moving or lifting the TV, disconnect the power cord and all cables.
- When holding the TV, the screen should face away from you to avoid damage.



- Hold the top and bottom of the TV frame firmly. Make sure not to hold the transparent part, speaker, or speaker grill area.

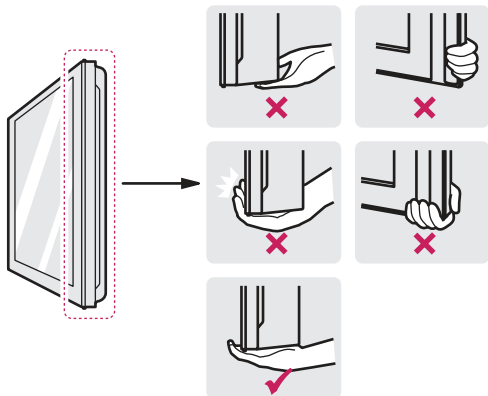

- When transporting a large TV, there should be at least 2 people.
- When transporting the TV by hand, hold the TV as shown in the following illustration.

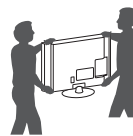

- When transporting the TV, do not expose the TV to jolts or excessive vibration.
- When transporting the TV, keep the TV upright, never turn the TV on its side or tilt towards the left or right.

Setting up the TV

The TV can be mounted to a wall or the stand can be attached if the TV will be positioned on an entertainment center or stand.

Attaching the stand

If you are not mounting the TV to a wall, use the following instructions to attach the stand.

CAUTION

- When attaching the stand to the TV set, place the screen facing down on a cushioned table or flat surface to protect the screen from scratches.
- Make sure that the screws are fastened tightly. (If they are not fastened securely enough, the TV may tilt forward after being installed.)
- Do not tighten the screws with too much force; otherwise they may be damaged and come loose later.

NOTE

- Remove the stand before installing the TV on a wall mount by performing the stand attachment in reverse.

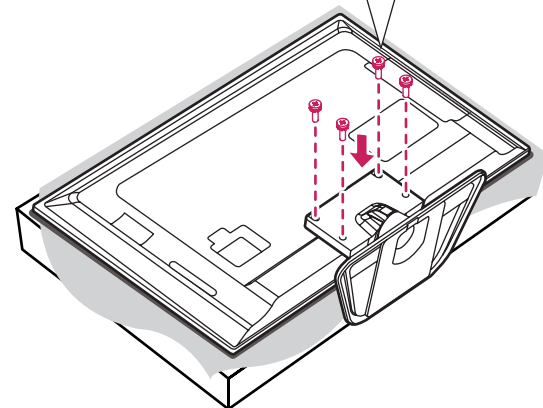
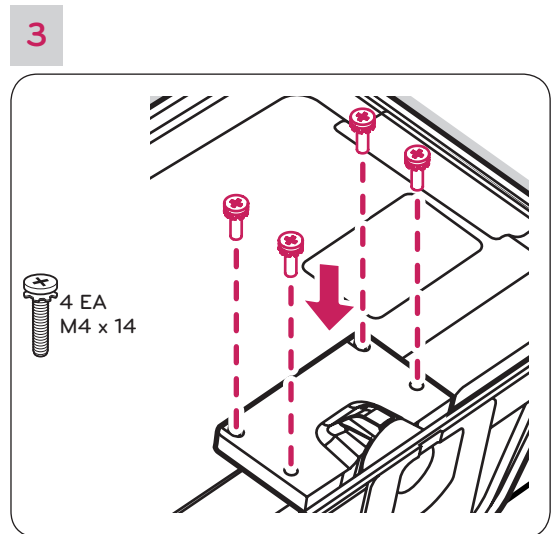
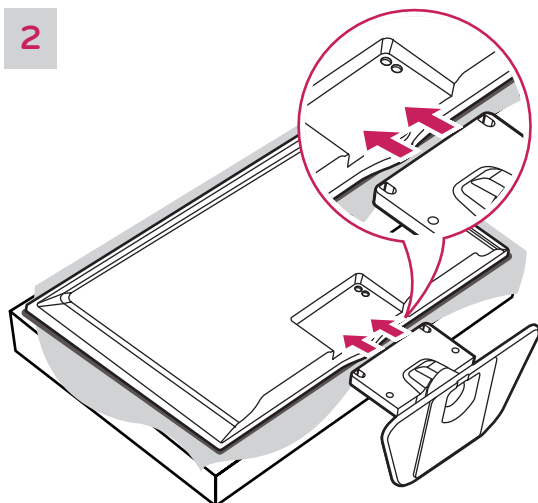
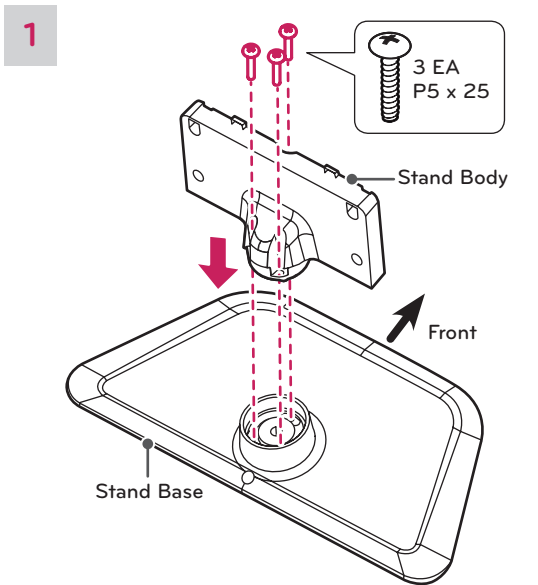

Mounting on a table

- 1 Lift and tilt the TV into its upright position on a table.
 - Leave a 10 cm (4 inch) (minimum) space from the wall for proper ventilation.

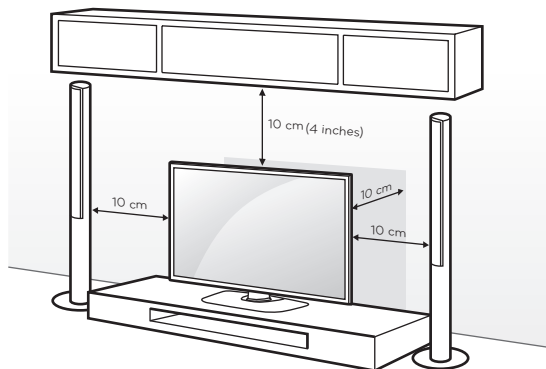

- 2 Connect the power cord to a wall outlet.

⚠ CAUTION

- Do not place the TV near or on sources of heat, as this may result in fire or other damage.

Securing the TV to a table

(For 32/39/42/47/50/60LN5700, 32LN570B, 47/50/60LN5710, 47/50/60LN5750, 47LN5790)

Fix the TV to a table to prevent from tilting forward, damage, and potential injury.

Mount the TV on a table, and then insert and tighten the supplied screw on the rear of the stand.

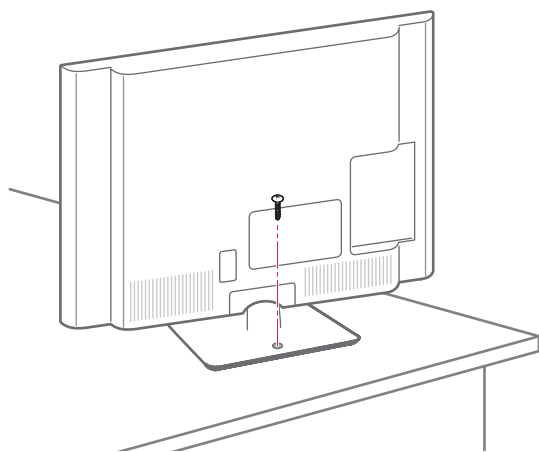

⚠ WARNING

- To prevent TV from falling over, the TV should be securely attached to the floor/wall per installation instructions. Tipping, shaking, or rocking the TV may cause injury.

Using the Kensington security system (optional)

(Depending on model)

The Kensington security system connector is located at the rear of the TV.

For more information of installation and using, refer to the manual provided with the Kensington security system or visit <http://www.kensington.com>.

Connect the Kensington security system cable between the TV and a table.

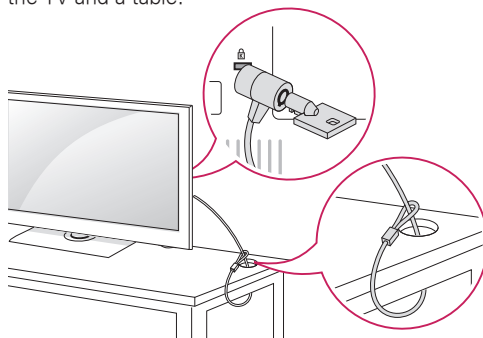

! NOTE

- The Kensington security system is optional. You can obtain additional accessories from your local dealer.

Securing the TV to a wall (optional)

(Depending on model)

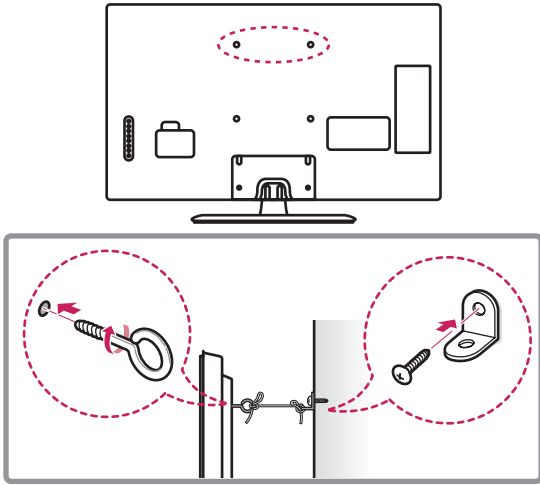

- 1 Insert and tighten the eye-bolts, or TV brackets and bolts on the back of the TV.
- If there are bolts inserted at the eye-bolts position, remove the bolts first.
- 2 Mount the wall brackets with the bolts to the wall. Match the location of the wall bracket and the eye-bolts on the rear of the TV.
- 3 Connect the eye-bolts and wall brackets tightly with a sturdy rope. Make sure to keep the rope horizontal with the flat surface.

! CAUTION

- Make sure that children do not climb on or hang on the TV.

! NOTE

- Use a platform or cabinet that is strong and large enough to support the TV securely.
- Brackets, bolts and ropes are optional. You can obtain additional accessories from your local dealer.

Tidying cables

- 1 Gather and bind the cables with the cable holder.

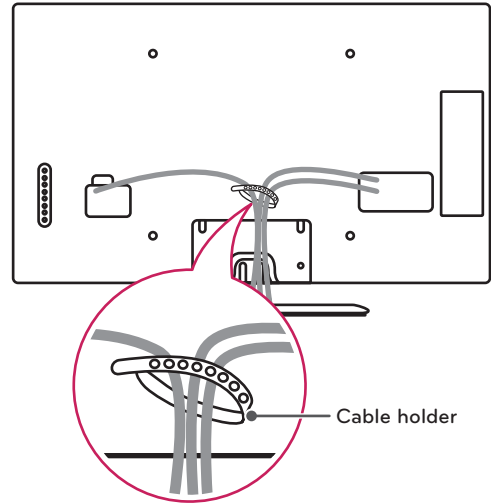
**! CAUTION**



- Do not move the TV by holding the cable holder, as the cable holders may break, and injuries and damage to the TV may occur.

Mounting on a wall

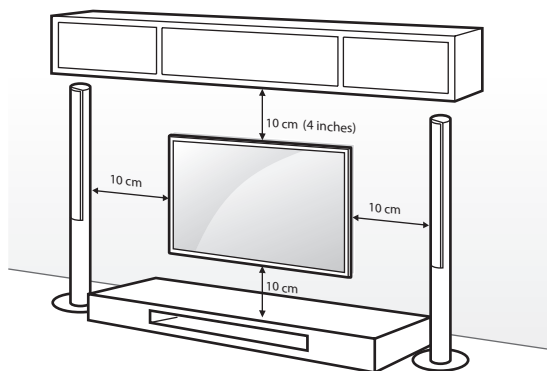
An optional wall mount can be used with your LG Television. Consult with your local dealer for a wall mount that supports the VESA standard used by your TV model. Carefully attach the wall mount bracket at the rear of the TV. Install the wall mount bracket on a solid wall perpendicular to the floor. If you are attaching the TV to other building materials, please contact qualified personnel to install the wall mount. Detailed instructions will be included with the wall mount. We recommend that you use an LG brand wall mount.

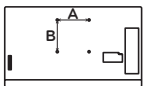

Make sure to use screws and wall mounts that meet the VESA standard. Standard dimensions for the wall mount kits are described in the following table.

| | | |
|-------------------------------------------------------------------------------------|------------------------------------------------------------------------------------------------|------------------------------------------------------------------------------------------------|
| Model | 32LN5700 32LN570B | 39/42LN5700 |
| VESA (A x B) | 200 x 100 | 200 x 200 |
|  | | |
| Standard screw | M4 | M6 |
| Number of screws | 4 | 4 |
| Wall mount bracket (optional) | LSW130B  | LSW230B  |

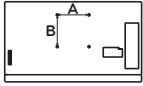
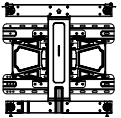
| | |
|-----------------------------------------------------------------------------------|-----------------------------------------------------------------------------------------------|
| Model | 47/50/55/60LN5700 47/50/55/60LN5710 47/50/55/60LN5750 47/55LN5790 |
| VESA (A x B) | 400 x 400 |
|  | |
| Standard screw | M6 |
| Number of screws | 4 |
| Wall mount bracket (optional) | LSW430B  |

CAUTION

- Disconnect the power before moving or installing the TV. Otherwise electric shock may occur.
- If you install the TV on a ceiling or slanted wall, it may fall and result in severe injury. Use an authorized LG wall mount and contact the local dealer or qualified personnel.
- Do not over tighten the screws as this may cause damage to the TV and void your warranty.
- Use the screws and wall mounts that meet the VESA standard. Any damages or injuries by misuse or using an improper accessory are not covered by the warranty.

NOTE

- Use the screws that are listed in the VESA standard screw specifications.
- The wall mount kit includes an installation manual and necessary parts.
- The wall mount bracket is optional. You can obtain additional accessories from your local dealer.
- The length of screws may differ depending on the wall mount. Make sure to use the proper length.
- For more information, refer to the manual supplied with the wall mount.

MAKING CONNECTIONS

- This section uses illustrations of the LN5790 series.

You can connect various external devices to the TV. Supported external devices are: HD receivers, DVD players, VCRs, audio systems, USB storage devices, PC, gaming devices, and other external devices. For more information on external device's connection, refer to the manual provided with each device.

NOTE

- If you record a TV program on a DVD recorder or VCR, make sure to connect the TV signal input cable to the TV through a DVD recorder or VCR. For more information of recording, refer to the manual provided with the connected device.
- The external device connections shown may differ slightly from illustrations in this manual.
- Connect external devices to the TV regardless of the order of the TV port.
- If you connect a gaming device to the TV, use the cable supplied with the gaming device.
- Refer to the external equipment's manual for operating instructions.

Connecting to an antenna or cable

Connect an antenna, cable, or cable box to watch TV while referring to the following. The illustrations may differ from the actual items and a RF cable is optional.

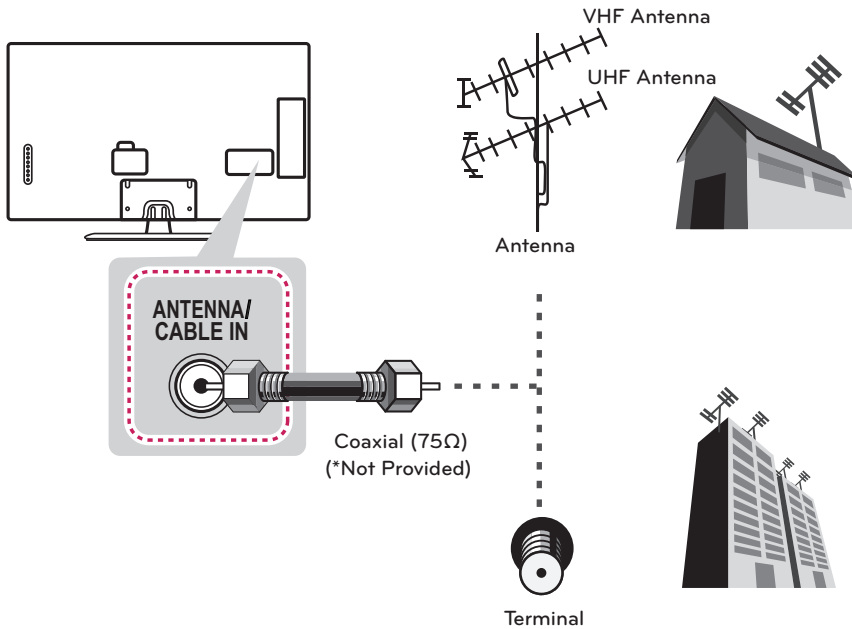

ENGLISH

CAUTION

- Make sure not to bend the copper wire of the RF cable.

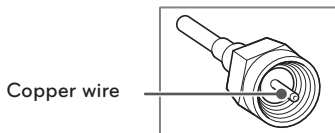

- Complete all connections between devices, and then connect the power cord to the power outlet to prevent damage to your TV.

NOTE

- Use a signal splitter to use more than 2 TVs.
- Visit '<http://lgknowledgebase.com>' for more information about the antenna and cable connection. Search for antenna.
- DTV Audio Supported Codec: MPEG, Dolby Digital.

Connecting to a HD receiver, DVD Player, or VCR

Connect a HD receiver, DVD Player, or VCR to the TV and select an appropriate input mode.

HDMI Connection

HDMI is the best way to connect a device.

Transmits the digital video and audio signals from an external device to the TV. Connect the external device and the TV with the HDMI cable as shown in the following illustration.



NOTE

- Use the latest High Speed HDMI™ Cable that supports CEC (Customer Electronics Control) function.
- High Speed HDMI™ Cables are tested to carry an HD signal up to 1080p and higher.
- HDMI Audio Supported Format: Dolby Digital, PCM (Up to 192 kHz, 32 kHz / 44.1 kHz / 48 kHz / 88 kHz / 96 kHz / 176 kHz / 192 kHz).

Choose any HDMI input port to connect.
It does not matter which port you use.

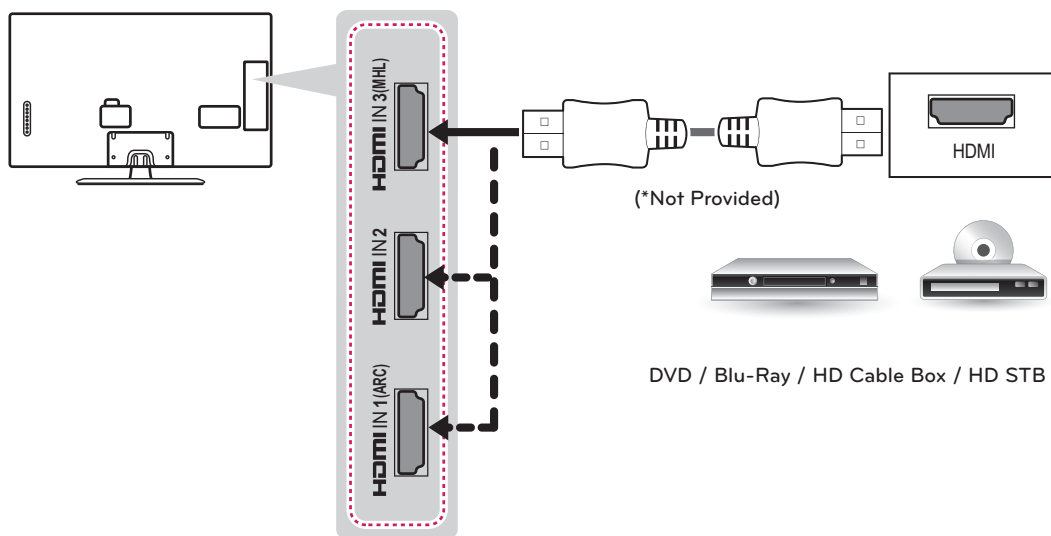

DVI to HDMI Connection

Transmits the digital video signal from an external device to the TV. Connect the external device and the TV with the DVI-HDMI cable as shown in the following illustration. To transmit an audio signal, connect an audio cable.

NOTE

- When using the HDMI/DVI cable, Single link is only supported.

Choose any HDMI input port to connect.
It does not matter which port you use.

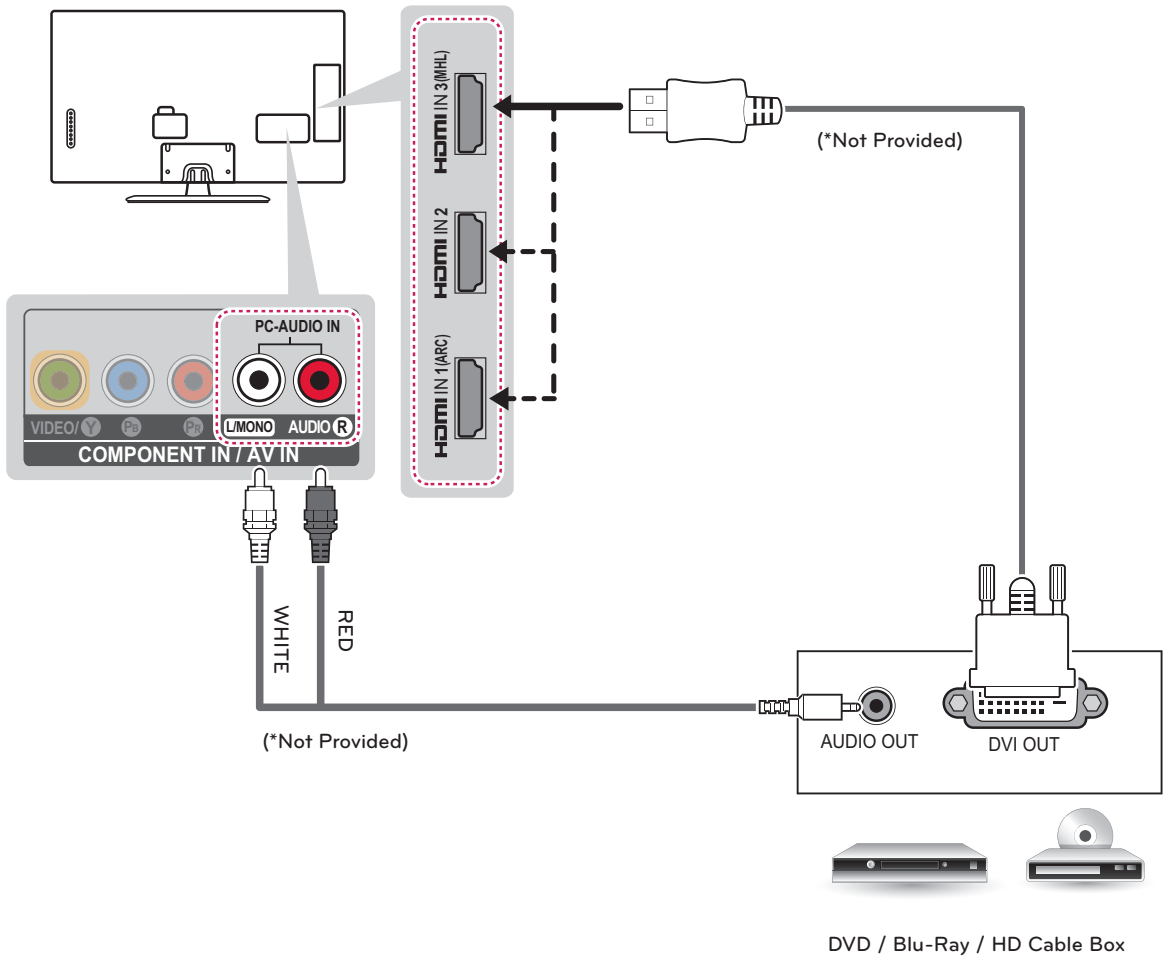

Connecting to a mobile phone

Mobile High-definition Link (MHL) is an interface for transmitting digital audiovisual signals from mobile phones to television sets.

! NOTE

- Connect the mobile phone to the HDMI IN 3 (MHL) port to view the phone screen on the TV.
- This only works for the MHL-enabled phone.
- With some MHL supporting mobile phones, you can use the TV remote to control the phone.
- An MHL passive cable is needed to connect the TV and a mobile phone.
- Remove the MHL cable from the TV when:
 - the MHL function is disabled.
 - your mobile device is fully charged in standby mode.

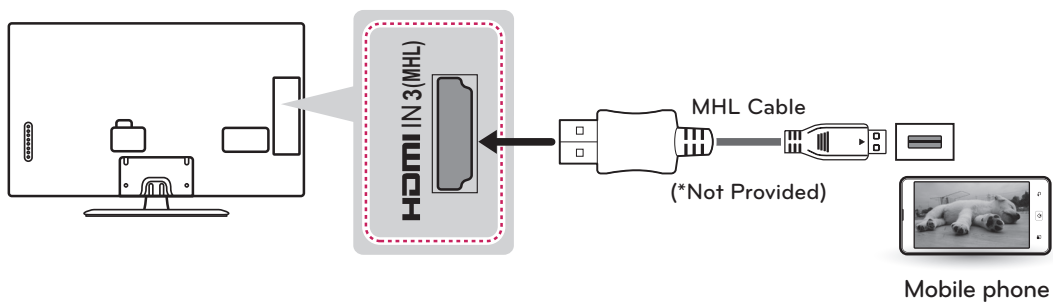

Component Connection

Transmits analog video and audio signals from an external device to the TV. Connect the external device and the TV with a component cable as shown in the following illustration.

NOTE

- If cables are installed incorrectly, it could cause the image to display in black and white or with distorted color.
- Check to ensure the cables are matched with the corresponding color connection.

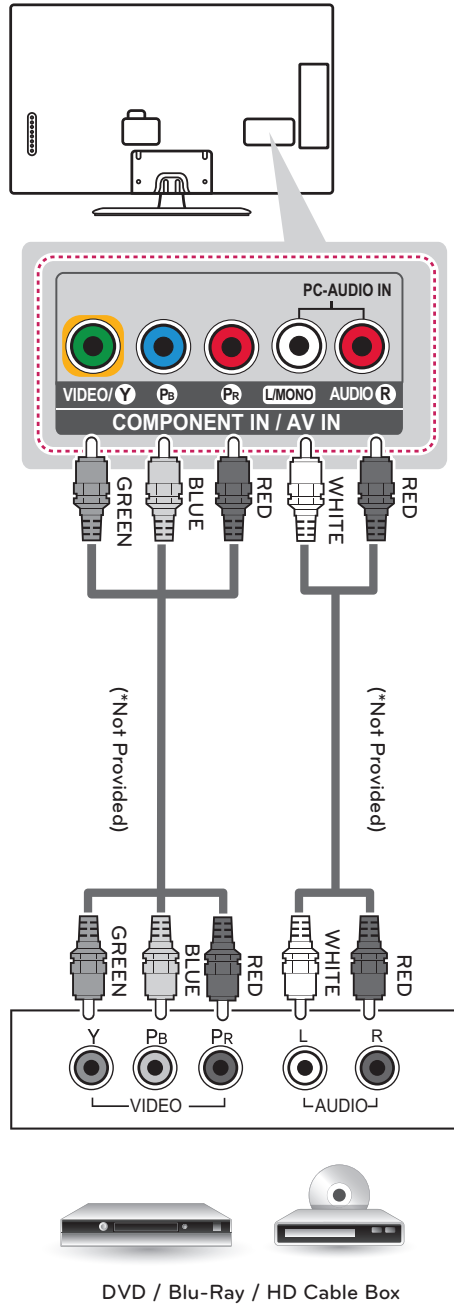

Composite Connection

Transmits analog video and audio signals from an external device to the TV. Connect the external device and the TV with the composite cable as shown in the following illustration.



NOTE

- If you have a mono VCR, connect the audio cable from the VCR to the AUDIO L/MONO jack of the TV.
- Check to ensure the cables are matched with the corresponding color connection.

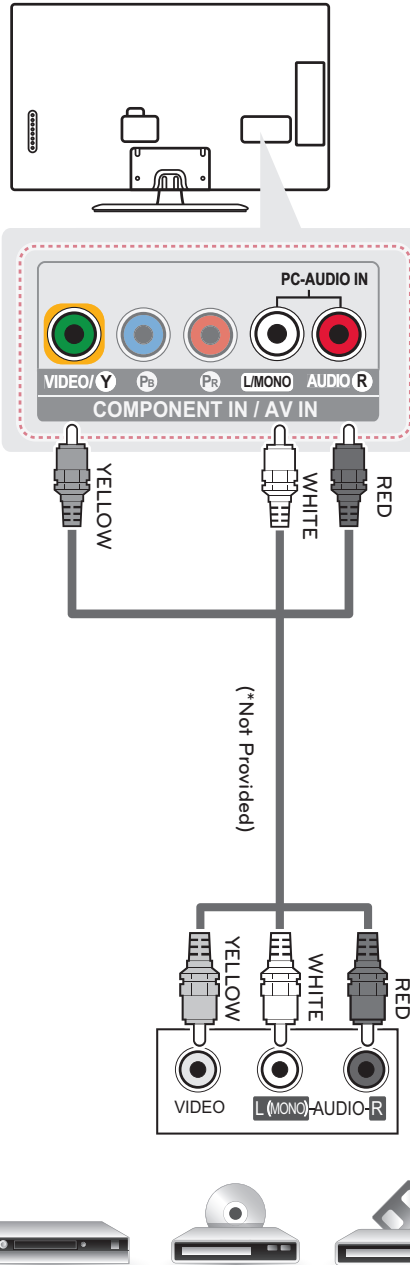

VCR / DVD / Blu-Ray / HD Cable Box

Connecting to a PC

! NOTE

- It is recommended to use an HDMI connection for the best image quality.
- Depending on the graphics card, DOS mode video may not work if a HDMI to DVI Cable is in use.
- In PC mode, there may be noise associated with the resolution, vertical pattern, contrast or brightness. If noise is present, change the PC output to another resolution, change the refresh rate to another rate or adjust the brightness and contrast on the PICTURE menu until the picture is clear.
- The synchronization input form for Horizontal and Vertical frequencies is separate.
- Depending on the graphics card, some resolution settings may not allow the image to be positioned on the screen properly.
- If you are using DVI out from a PC, you have to connect analog audio separately. Refer to the instructions on the next page.
- When using the HDMI/DVI cable, Single link is only supported.

HDMI Connection or DVI to HDMI Connection

Choose method A or B to make connection.

Method A: HDMI Connection

Choose any HDMI input port to connect.
It does not matter which port you use.

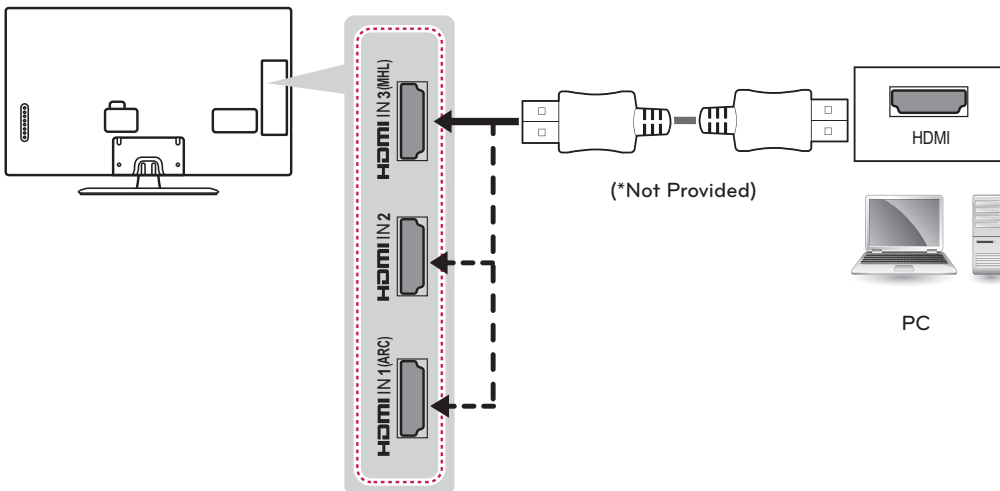

Method B: DVI to HDMI Connection

Choose any HDMI input port to connect.
It does not matter which port you use.

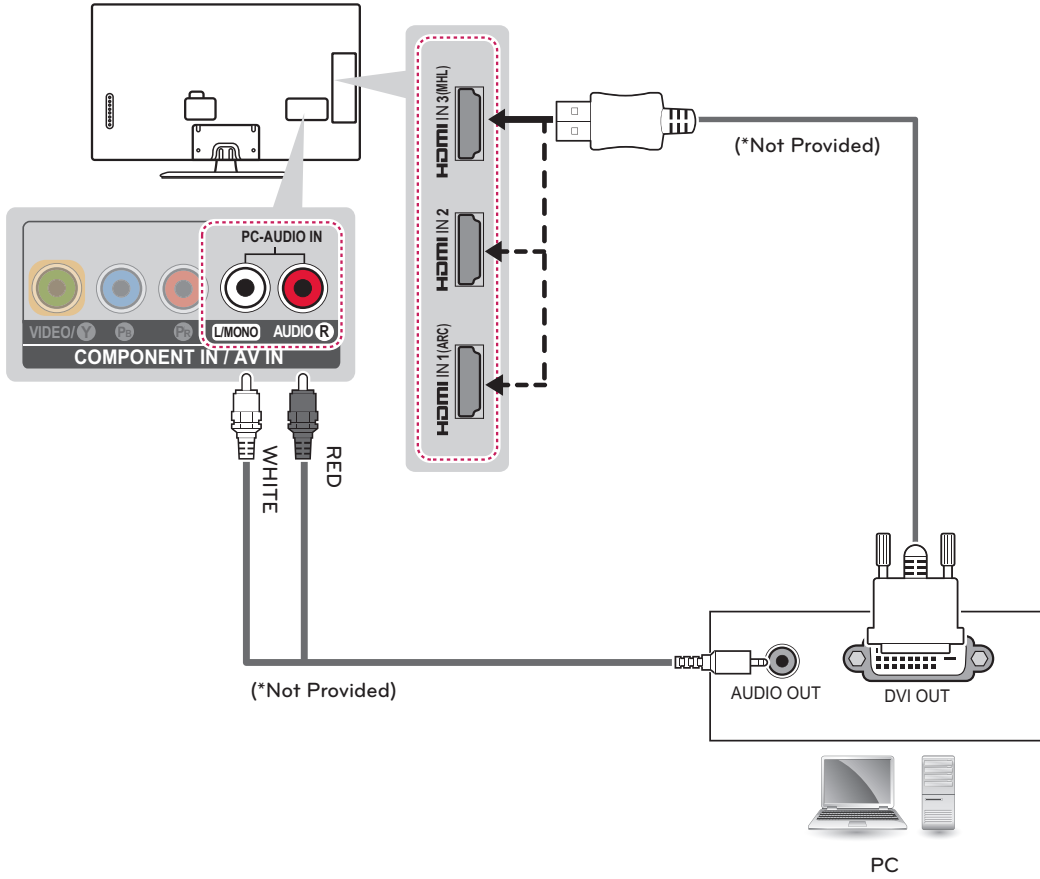

Connecting to an Audio System

You may use an optional external audio system instead of the built-in speaker.

Digital Optical Audio Connection

Transmits a digital audio signal from the TV to an external device. Connect the external device and the TV with the optical audio cable as shown in the following illustration.



NOTE

- Do not look into the optical output port. Looking at the laser beam may damage your vision.
- Audio with ACP (Audio Copy Protection) function may block digital audio output.

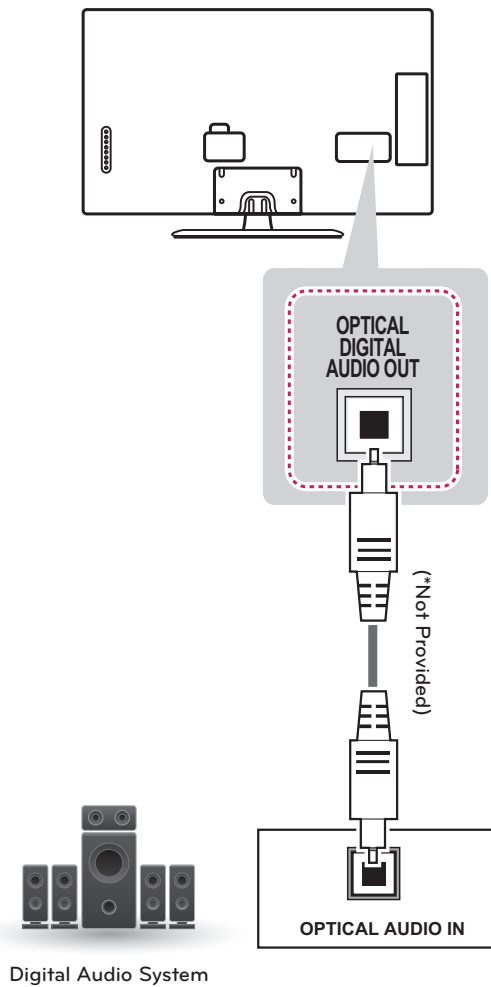

Connecting to a Sound Bar

You may use a Sound Bar instead of the built-in speaker.

**NOTE**

- If you use a Sound Bar instead of the built-in speaker, set the TV speaker to off in the user menu.

Digital Optical Audio Connection

Transmits a digital audio signal from the TV to a Sound Bar. Connect the Sound Bar and the TV with an optical audio cable as shown in the following illustration.

For LN5790 series

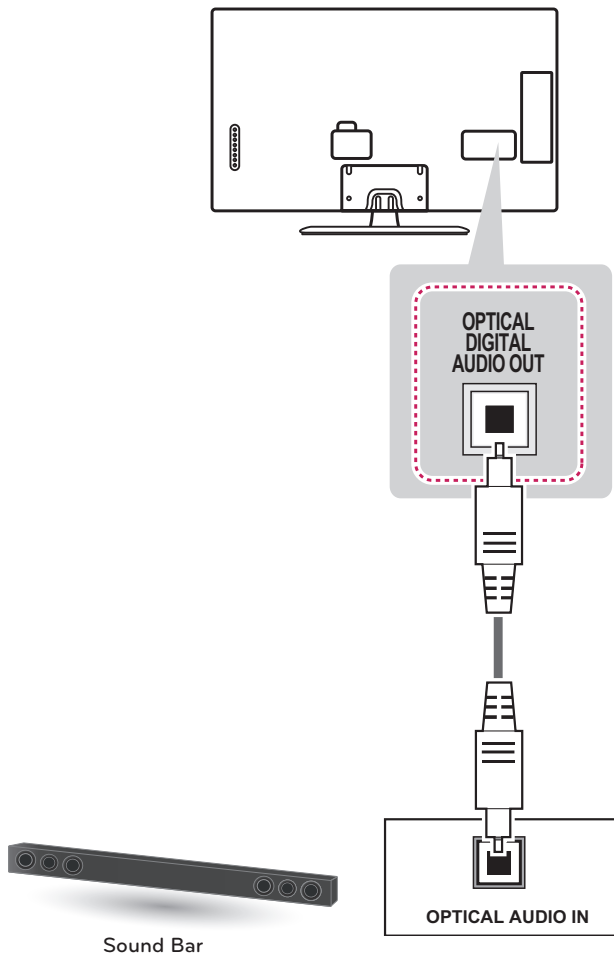

Connecting Headphones

You listen to the sound using headphones.



NOTE

- AUDIO menu options are disabled when headphones are connected.
- When changing AV MODE with headphones connected, the change is applied to video but not to audio.
- Optical Digital Audio Out is not available when headphones are connected.
- Headphone impedance: 16 Ω
- Max audio output: 10 mW to 15 mW
- Headphone jack size: 0.35 cm (0.13 inches)

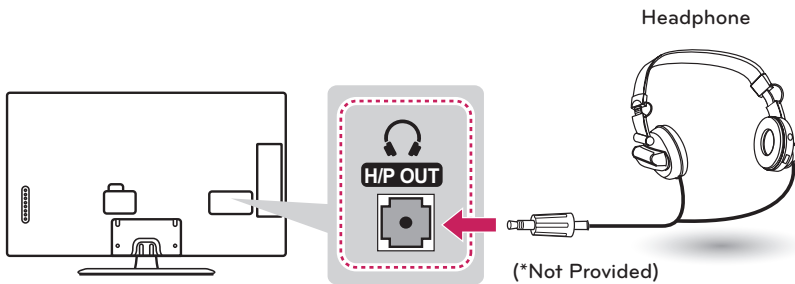

Connecting a USB Drive

Connect a USB storage device such as a USB flash thumbdrive, external hard drive, or a USB memory card reader to the TV and access the Smart Share menu to use various multimedia files.



NOTE

- Some USB Hubs may not work. If a USB device connected using a USB Hub is not detected, connect it to the USB port on the TV directly.

Choose any USB input port to connect.
It does not matter which port you use.

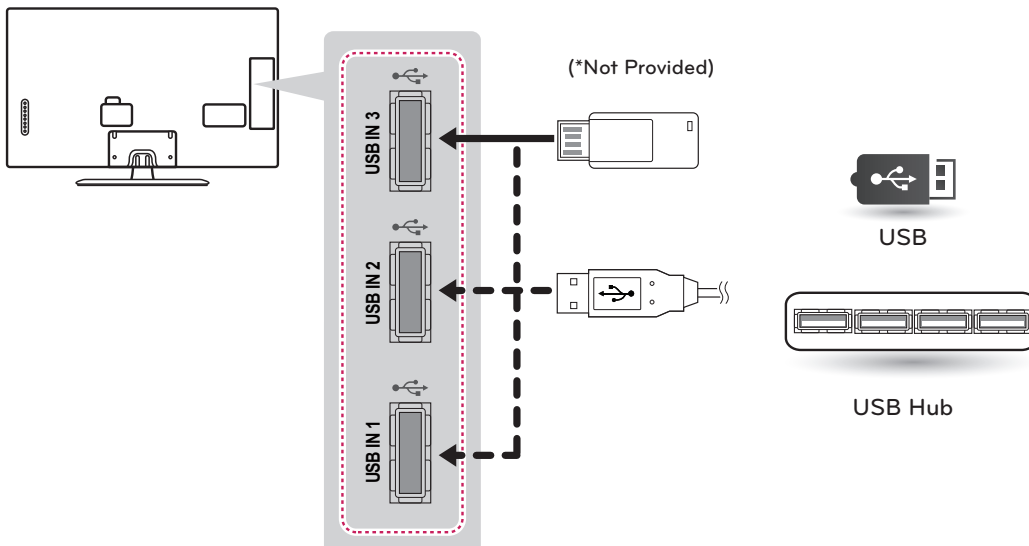

REMOTE CONTROL

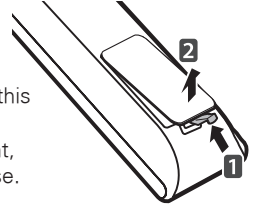

The descriptions in this manual are based on the buttons on the remote control. Please read this manual carefully and use the TV correctly. To install batteries, open the battery cover, replace batteries (1.5 V AAA) matching the ⊕ and ⊖ ends to the label inside the compartment, and close the battery cover. To remove the batteries, perform the installation actions in reverse.

⚠ CAUTION

- Do not mix old and new batteries, as this may damage the remote control.

This remote uses infrared light. When in use, it should be pointed in the direction of the TV's remote sensor.

For LN5700, LN570B, LN5710, LN5790 series

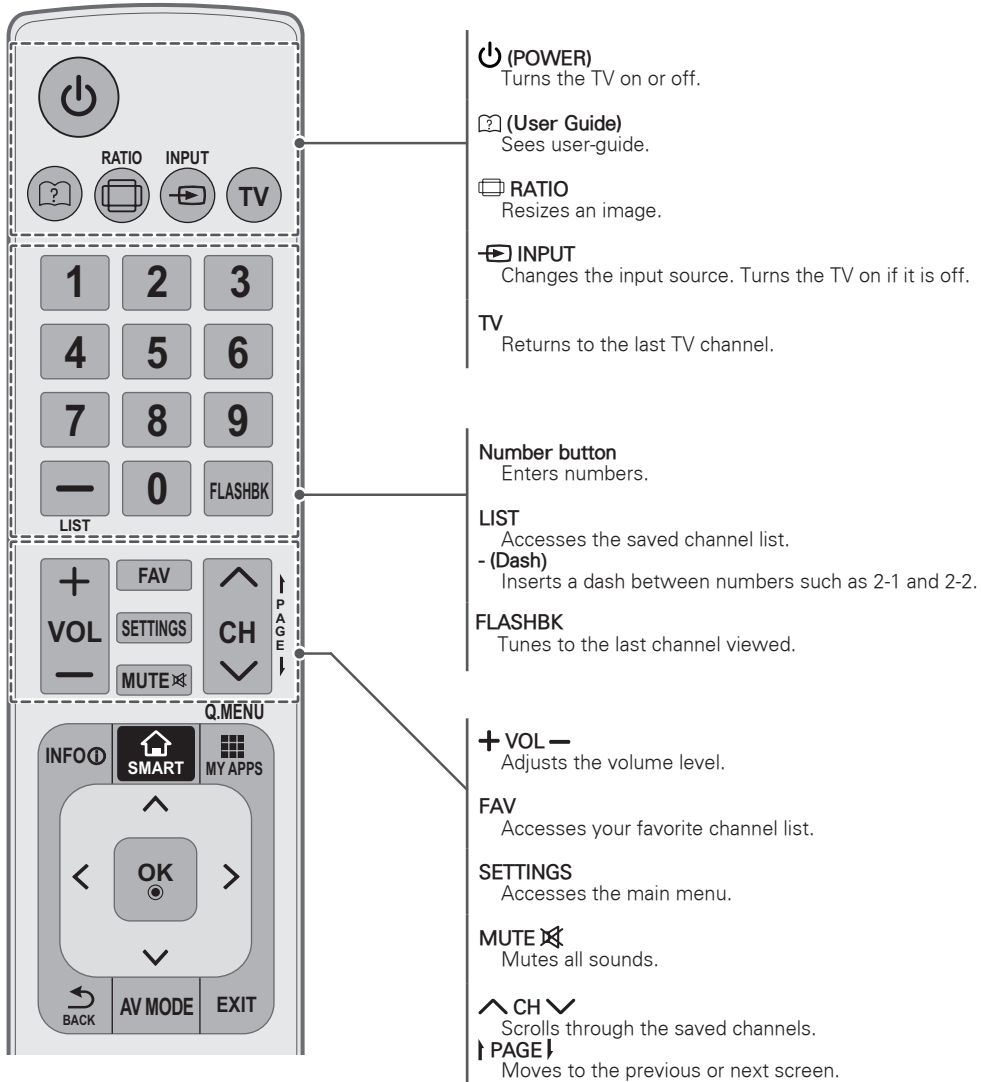

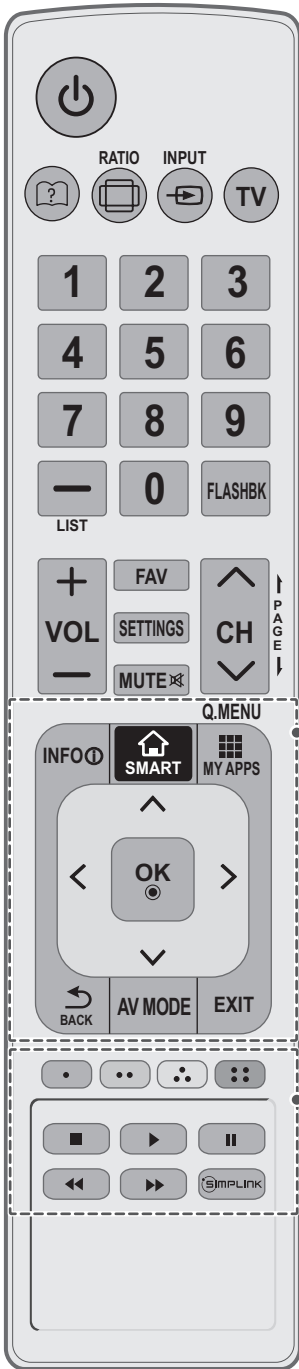

INFO ⓘ

Shows information on the current program.

SMART 🏠

Accesses the Smart Home menu.

MY APPS 📺

Shows the list of Apps.

Q.MENU ⌘

Accesses the quick menu.

Navigation buttons (up/down/left/right)

Scrolls through menus or options.

OK Ⓞ

Selects menus or options and confirms your input.

BACK ↶

Returns to the previous level.

AV MODE 📺

Selects an AV mode.

EXIT ✖

Clears all on-screen displays and returns to TV viewing.

Color buttons

These access special functions in some menus.

(●) : Red, (●●) : Green, (●●●) : Yellow, (●●●●) : Blue

Control buttons (■, ▶, ⏸, ⏪, ⏩)

Controls the SIMPLINK compatible devices (USB, SIMPLINK).

SIMPLINK 🔗

Accesses the AV devices connected to the TV;
Opens the SIMPLINK menu.

MAGIC REMOTE CONTROL FUNCTIONS

When the message "Magic remote control battery is low. Change the battery." is displayed, replace the battery. To install batteries, open the battery cover, replace batteries (1.5 V AA) matching ⊕ and ⊖ ends to the label inside the compartment, and close the battery cover. Be sure to point the remote control at the remote control sensor on the TV. To remove the batteries, perform the installation actions in reverse.

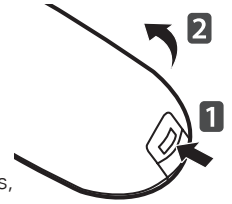

CAUTION

- Do not mix old and new batteries, as this may damage the remote control.

This remote uses infrared light. When in use, it should be pointed in the direction of the TV's remote sensor.

For LN5750 series

ENGLISH

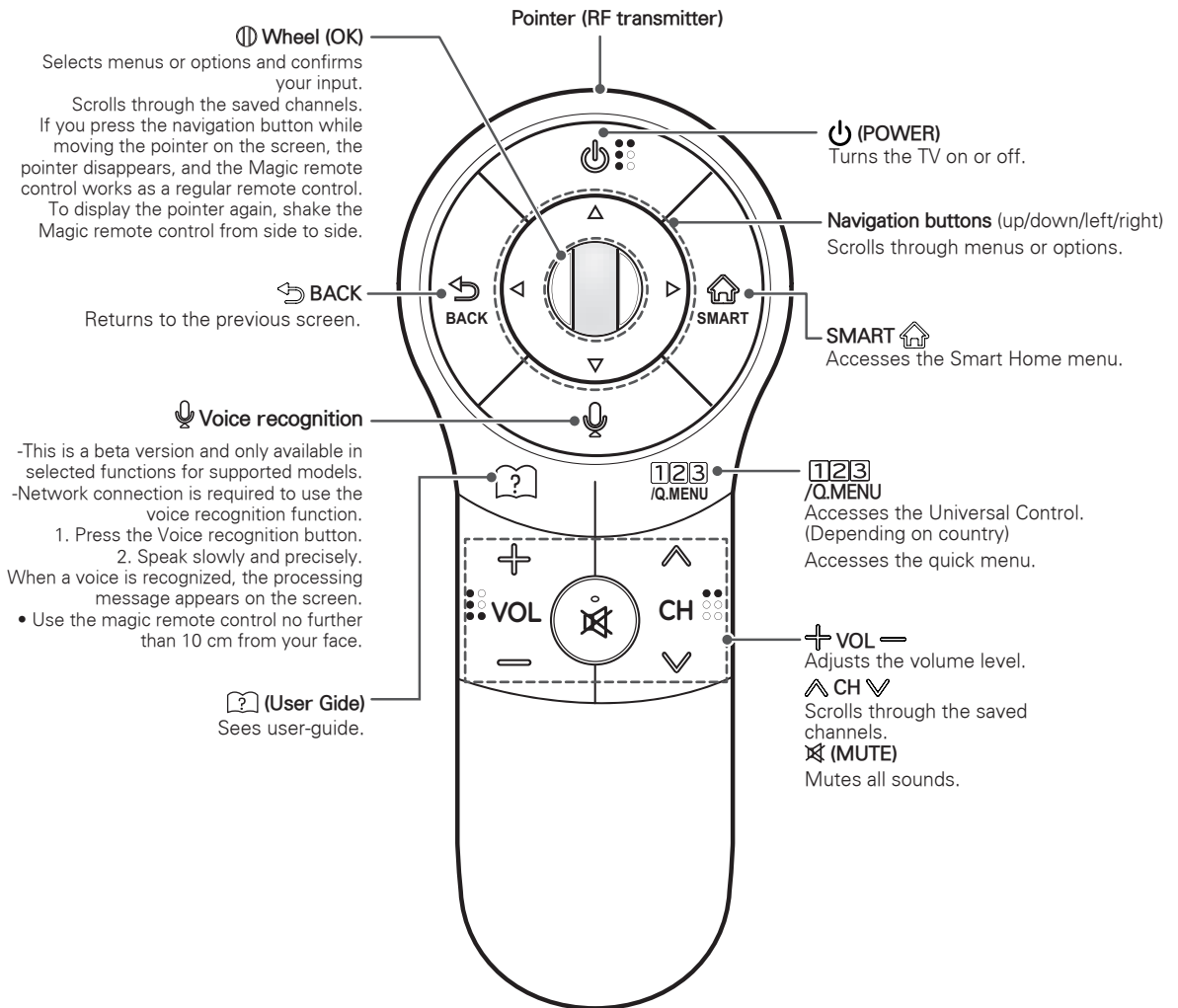



Registering Magic Remote Control

The Magic Remote Control operates by pairing with your TV.

How to register the Magic Remote Control

| | |
|-----------------------------------------------------------------------------------------------------|---------------------------------------------------------------------------------------------------------------------------------------------------------------------------------------------------------------------------------------------------------------------------------------|
|  (Wheel) | <p>To register automatically, turn the TV on and press the Wheel (OK). When registration is completed, the completion message appears on the screen.</p> <p>If registration fails, turn the TV off and back on, then press the Wheel (OK) to complete registration.</p> |
|-----------------------------------------------------------------------------------------------------|---------------------------------------------------------------------------------------------------------------------------------------------------------------------------------------------------------------------------------------------------------------------------------------|

How to Re-register the Magic Remote Control

| | |
|-----------------------------------------------------------------------------------------------------------------------------------------------------------------------------------------------------------|--------------------------------------------------------------------------------------------------------------------------------------------------------------------------------------------------------------------------------------------------------------------------------------------------------|
|  BACK  SMART | <p>1 Press and hold the BACK and SMART buttons together for 5 seconds to reset, then register it by following "How to register the Magic remote control" above.</p> <p>2 To re-register the Magic remote control, press and hold the BACK button for 5 seconds toward the TV.</p> |
|-----------------------------------------------------------------------------------------------------------------------------------------------------------------------------------------------------------|--------------------------------------------------------------------------------------------------------------------------------------------------------------------------------------------------------------------------------------------------------------------------------------------------------|

How to use Magic Remote Control

| | |
|-------------------------------------------------------------------------------------|----------------------------------------------------------------------------------------------------------------------------------------------------------------------------------------------------------------------------------------------------------------------------------------------------------------------------------------------------------------------------------------------------------------------------------------------------------------------------------------------------|
|  | <p>1 You can move the pointer by moving the remote up and down or left and right.</p> <ul style="list-style-type: none"> » If the pointer does not work properly, wait 10 seconds and then try again. <p>2 If the pointer disappears, move the remote control slightly to left or right. It will then automatically appear on the screen.</p> <ul style="list-style-type: none"> » If the pointer has not been used for a certain period of time, it will disappear. |
|-------------------------------------------------------------------------------------|----------------------------------------------------------------------------------------------------------------------------------------------------------------------------------------------------------------------------------------------------------------------------------------------------------------------------------------------------------------------------------------------------------------------------------------------------------------------------------------------------|

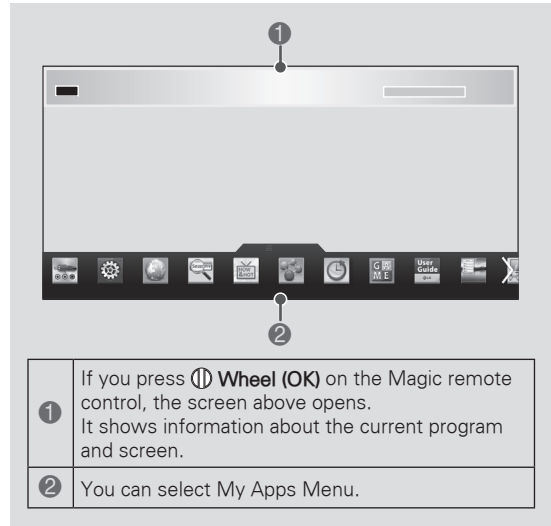

Precautions to Take when Using the Magic Remote Control

- Use the Magic remote control within the maximum communication distance (10 m, 32.8ft). Using the remote control beyond this distance, or with an object obstructing it, may cause a communication failure.
- A communication failure may occur due to nearby devices. Electrical devices such as a microwave oven or wireless LAN product may cause interference, as these use the same bandwidth (2.4 GHz) as the Magic remote control.
- The Magic remote control may be damaged or may malfunction if it is dropped or receives a heavy impact.
- Take care not to bump into nearby furniture or other people when using the Magic remote control.
- Manufacturer and installer cannot provide service related to human safety as the applicable wireless device has possibility of electric wave interference.
- It is recommended that an Access Point (AP) be located more than 1 m (3.28 ft) away from the TV. If the AP is installed closer than 1 m (3.28 ft), the Magic remote control may not perform as expected due to frequency interference.

WATCHING TV

Turning the TV on for the first time

When you turn the TV on for the first time, the Initial setting screen appears. Select a language and customize the basic settings.

- 1 Connect the power cord to a power outlet.
- 2 In Standby mode, press the power button on the remote control to turn the TV on. The Initial setting screen appears if you turn the TV on for the first time.

NOTE

- You can also access **Initial Setting** by accessing **OPTION** in the main menu.

- 3 Follow the on-screen instructions to customize your TV settings according to your preferences.

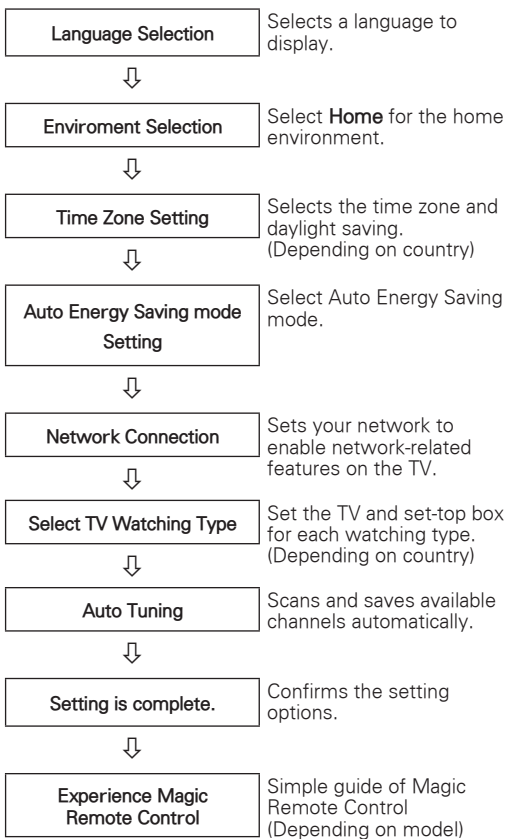

NOTE

- Select **Home** when prompted. **Store** mode puts the TV in demo mode.
- If you select **Store**, the any customized settings will switch back to the default settings of **Store** in 5 minutes.
- The Standby light feature is disabled in Store Demo mode.

- 4 When the basic settings are complete, press the **Wheel (OK)** button.

NOTE

- If you do not complete the Initial setting, it will appear whenever the TV turns on.
- Disconnect the power cord from the power outlet when you do not use the TV for a long period of time.



- 5 To turn the TV off, press the power button on the remote control.

USING THE USER GUIDE

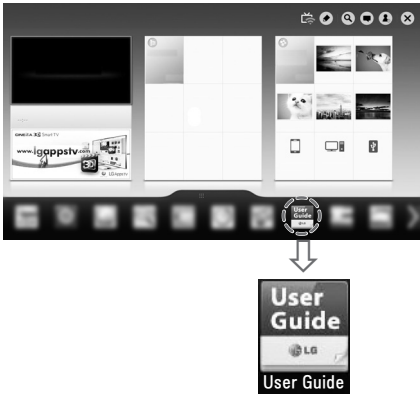

User Guide allows you to easily access detailed TV information.

- 1 Press **SMART**  button to access the Smart Home menu.
- 2 Select **User Guide** and press the **Wheel (OK)** button.



| | |
|---|------------------------------------------------------------------------------------------------------------------------------------------------------------------------------------------------------------------------------------------------------|
| 1 | Shows the description of the selected menu. You can use  /  to move between pages. |
| 2 | Moves to the selected menu directly from the User Guide. |

(Depending on country)

| | |
|---|-------------------------------------------------------------------------------------------------------------------------------------------------------------------------------------------------------------------------------------------------------------|
| 1 | Shows the video you were watching. |
| 2 | Guide categories. |
| 3 | List of topics in the current category. You can use  /  button to move between pages. |
| 4 | An index of key words present in the User Guide. |
| 5 | Provides the detailed information on the functions of LG Smart TV when the Internet is connected. (It may not be available depending on the country/language.) |

SPECIFICATIONS

Product specifications may be changed without prior notice due to upgrade of product functions.

| | | |
|-----------------------------------|-----------------------|--------------------------------------------------------|
| Power requirement | | AC 100 - 240 V ~ 50 / 60 Hz |
| Television System | | ATSC / NTSC-M, 64 & 256 QAM |
| Program Coverage | | VHF 2-13, UHF 14-69, CATV 1-135, DTV 2-69, CADTV 1-135 |
| External Antenna Impedance | | 75 Ω |
| Environment condition | Operating Temperature | 0 - 40 °C |
| | Operating Humidity | Less than 80 % |
| | Storage Temperature | -20 - 60 °C |
| | Storage Humidity | Less than 85 % |

| MODELS | | 32LN5700 (32LN5700-UH) | 39LN5700 (39LN5700-UH) |
|-------------------------------------|---------------|---------------------------|---------------------------|
| | | 32LN570B (32LN570B-UH) | |
| Dimensions (Width x Height x Depth) | With stand | 738 x 497 x 207 (mm) | 894 x 587 x 236 (mm) |
| | | 29.0 x 19.5 x 8.1 (inch) | 35.1 x 23.1 x 9.2 (inch) |
| | Without stand | 738 x 449 x 79 (mm) | 894 x 537 x 79 (mm) |
| | | 29.0 x 17.6 x 3.1 (inch) | 35.1 x 21.1 x 3.1 (inch) |
| Weight | With stand | 7.0 kg (15.4 lbs) | 9.7 kg (21.3 lbs) |
| | Without stand | 6.4 kg (14.1 lbs) | 8.6 kg (18.9 lbs) |
| Current Value / Power consumption | | 1.3 A / 80 W | 1.5 A / 100 W |

| MODELS | | 42LN5700 (42LN5700-UH) |
|-------------------------------------|---------------|---------------------------|
| Dimensions (Width x Height x Depth) | With stand | 968 x 629 x 236 (mm) |
| | | 38.1 x 24.7 x 9.2 (inch) |
| | Without stand | 968 x 579 x 79 (mm) |
| | | 38.1 x 22.7 x 3.1 (inch) |
| Weight | With stand | 10.7 kg (23.5 lbs) |
| | Without stand | 9.6 kg (21.1 lbs) |
| Current Value / Power consumption | | 1.1 A / 110 W |

| MODELS | | 47LN5700 (47LN5700-UH) |
|-------------------------------------|---------------|---------------------------|
| | | 47LN5710 (47LN5710-UI) |
| | | 47LN5750 (47LN5750-UH) |
| | | 47LN5790 (47LN5790-UI) |
| Dimensions (Width x Height x Depth) | With stand | 1,080 x 694 x 264 (mm) |
| | | 42.5 x 27.3 x 10.3 (inch) |
| | Without stand | 1,080 x 642 x 80.5 (mm) |
| | | 42.5 x 25.2 x 3.1 (inch) |
| Weight | With stand | 14.7 kg (32.4 lbs) |
| | Without stand | 13.4 kg (29.5 lbs) |
| Current Value / Power consumption | | 1.3 A / 130 W |

| MODELS | | 50LN5700 (50LN5700-UH) |
|-------------------------------------|---------------|---------------------------|
| | | 50LN5710 (50LN5710-UI) |
| | | 50LN5750 (50LN5750-UH) |
| Dimensions (Width x Height x Depth) | With stand | 1,136 x 727 x 264 (mm) |
| | | 44.7 x 28.6 x 10.3 (inch) |
| | Without stand | 1,136 x 673 x 82.1 (mm) |
| | | 44.7 x 26.4 x 3.2 (inch) |
| Weight | With stand | 15.6 kg (34.3 lbs) |
| | Without stand | 14.2 kg (31.3 lbs) |
| Current Value / Power consumption | | 1.4 A / 140 W |

| MODELS | | 55LN5700 (55LN5700-UH) |
|-------------------------------------|---------------|---------------------------|
| | | 55LN5710 (55LN5710-UI) |
| | | 55LN5750 (55LN5750-UH) |
| | | 55LN5790 (55LN5790-UI) |
| Dimensions (Width x Height x Depth) | With stand | 1,250 x 790 x 297 (mm) |
| | | 49.2 x 31.1 x 11.6 (inch) |
| | Without stand | 1,250 x 737 x 79.1 (mm) |
| | | 49.2 x 29.0 x 3.1 (inch) |
| Weight | With stand | 21.2 kg (46.7 lbs) |
| | Without stand | 19.1 kg (42.1 lbs) |
| Current Value / Power consumption | | 1.6 A / 160 W |

| MODELS | | 60LN5700 (60LN5700-UA) |
|-------------------------------------|---------------|---------------------------|
| | | 60LN5710 (60LN5710-UB) |
| | | 60LN5750 (60LN5750-UA) |
| Dimensions (Width x Height x Depth) | With stand | 1,359 x 852 x 297 (mm) |
| | | 53.5 x 33.5 x 11.6 (inch) |
| | Without stand | 1,359 x 799 x 67.2 (mm) |
| | | 53.5 x 31.4 x 2.6 (inch) |
| Weight | With stand | 26.3 Kg (57.9 lbs) |
| | Without stand | 24.2 Kg (53.3 lbs) |
| Current Value / Power consumption | | 2.0 A / 200 W |

HDMI (DTV) supported mode

| Resolution | Horizontal Frequency (kHz) | Vertical Frequency (Hz) |
|------------|-------------------------------------------------------------------------|---------------------------------------------------------------------|
| 720x480 | 31.469 31.50 | 59.94 60.00 |
| 1280x720 | 44.96 45.00 | 59.94 60.00 |
| 1920x1080 | 33.72 33.75 26.97 27.000 33.716 33.75 67.43 67.500 | 59.94 60.00 23.97 24.000 29.976 30.00 59.94 60 |

Component supported mode

| Resolution | Horizontal Frequency (kHz) | Vertical Frequency (Hz) |
|------------|----------------------------|-------------------------|
| 720x480i | 15.73 | 59.94 |
| | 15.73 | 60.00 |
| 720x480p | 31.47 | 59.94 |
| | 31.50 | 60 |
| 1280x720p | 44.96 | 59.94 |
| | 45.00 | 60.00 |
| 1920x1080i | 33.72 | 59.94 |
| | 33.75 | 60.00 |
| 1920x1080p | 26.97 | 23.976 |
| | 27.00 | 24.00 |
| | 33.71 | 29.97 |
| | 33.75 | 30.00 |
| | 67.432 | 59.94 |
| | 67.500 | 60.00 |

Component port connecting information

| Component ports on the TV | Y | PB | PR |
|---------------------------|---|----|----|
| | | | |

| Video output ports on DVD player | Y | PB | PR |
|----------------------------------|---|-----|-----|
| | Y | B-Y | R-Y |
| | Y | Cb | Cr |
| | Y | Pb | Pr |

HDMI (PC) supported mode

| Resolution | Horizontal Frequency (kHz) | Vertical Frequency (Hz) |
|------------|----------------------------|-------------------------|
| 640x480 | 31.469 | 59.94 |
| 800x600 | 37.879 | 60.31 |
| 1024x768 | 48.363 | 60.00 |
| 1152x864 | 54.348 | 60.053 |
| 1360x768 | 47.712 | 60.015 |
| 1280x1024 | 63.981 | 60.020 |
| 1920x1080 | 67.5 | 60.00 |

Wireless LAN module (WN8122E1) specification

(For LN5700, LN570B, LN5750 series)

| | |
|----------------------------|---------------------------------------------------------------------------------------------------------------------|
| Standard | IEEE802.11a/b/g/n |
| Frequency Range | 2400 to 2483.5 MHz 5150 to 5250 MHz 5725 to 5850 MHz |
| Output Power (Max.) | 802.11a: 16.5 dBm 802.11b: 16 dBm 802.11g: 15.5 dBm 802.11n - 2.4GHz: 15.5 dBm 802.11n - 5GHz: 16.5 dBm |

- Because band channel used by the country could be different, the user can not change or adjust the operating frequency and this product is set for the regional frequency table.
- Contains FCC ID: BEJWN8122E1
Contains IC: 2703H-WN8122E1

Bluetooth module (BM-LDS401) specification

(For LN5750 series)

| | |
|----------------------------|-----------------------|
| Standard | Bluetooth Version 3.0 |
| Frequency Range | 2400 ~ 2483.5 MHz |
| Output Power (Max.) | 10 dBm or lower |

- Contains FCC ID: BEJLDS401
Contains IC: 2703H-LDS401

EXTERNAL CONTROL DEVICE SETUP

To obtain the external control device setup information, please visit 'www.lg.com'.

MAINTENANCE

Cleaning Your TV

Clean your TV regularly to keep it at peak performance and to extend the product lifespan.



CAUTION

- Before Cleaning, turn the power off and disconnect the power cord and all other cables.
- When the TV is left unattended or unused for a long time, disconnect the power cord from the wall outlet to prevent possible damage from lightning or power surges.

Screen, frame, cabinet and stand

To remove dust or light dirt, wipe the surface with a dry, clean, and soft cloth.

To remove major dirt, wipe the surface with a soft cloth dampened in clean water or a diluted mild detergent. Then wipe immediately with a dry cloth.



CAUTION

- Do not push, rub, or hit the surface with your fingernail or a sharp object, as this may result in scratches on the screen and image distortions.
- Do not use any chemicals, such as waxes, benzene, alcohol, thinners, insecticides, air fresheners, lubricants, as these may damage the screen's finish and cause discoloration.
- Do not spray liquid onto the surface. If water enters the TV, it may result in fire, electric shock, or malfunction.

Power cord

Remove the accumulated dust or dirt on the power cord regularly.

TROUBLESHOOTING

| Problem | Solution |
|------------------------------------------------|----------------------------------------------------------------------------------------------------------------------------------------------------------------------------------------------------------------------------------------------------------------------------------------------------------------------------------|
| Cannot control the TV with the remote control. | <ul style="list-style-type: none"> • Check the remote control sensor on the product and try again. • Check if there is any obstacle between the product and the remote control. • Check if the batteries are still working and properly installed (⊕ to ⊕, ⊖ to ⊖). |
| No image display and no sound is produced. | <ul style="list-style-type: none"> • Check if the product is turned on. • Check if the power cord is connected to a wall outlet. • Check if there is a problem in the wall outlet by connecting other products. |
| The TV turns off suddenly. | <ul style="list-style-type: none"> • Check the power control settings. The power supply may be interrupted. • Check if the Auto sleep feature is activated in the Time settings. • If there is no signal while the TV is on, the TV will turn off automatically after 15 minutes of inactivity. |



The model and serial number of the TV is located on the back and/or one side of the TV.

Record it below should you ever need service.

MODEL _____

SERIAL _____

LG Customer Information Center

For inquires or comments, visit www.lg.com or call;

1-888-542-2623 CANADA

1-800-243-0000 USA, Consumer User

1-888-865-3026 USA, Commercial User

Register your product Online!

www.lg.com



This product qualifies for ENERGY STAR in the "factory default (Home Use)" setting.

Changing the factory default settings or enabling other features may increase power consumption that could exceed the limits necessary to qualify for ENERGY STAR.



LG

Life's Good

OWNER'S MANUAL

EXTERNAL CONTROL DEVICE SETUP

Please read this manual carefully before operating the set and retain it for future reference.

KEY CODES

- This feature is not available for all models.

| Code (Hexa) | Function | Note | Code (Hexa) | Function | Note |
|-------------|-----------------------------|------------|-------------|------------------------------|------------|
| 00 | CH +, PR + | R/C Button | 45 | Q.Menu | R/C Button |
| 01 | CH -, PR - | R/C Button | 4C | List, - (ATSC Only) | R/C Button |
| 02 | Volume + | R/C Button | 53 | List | R/C Button |
| 03 | Volume - | R/C Button | 5B | Exit | R/C Button |
| 06 | > (Arrow Key / Right Key) | R/C Button | 61 | Blue | R/C Button |
| 07 | < (Arrow Key / Left Key) | R/C Button | 63 | Yellow | R/C Button |
| 08 | Power | R/C Button | 71 | Green | R/C Button |
| 09 | Mute | R/C Button | 72 | Red | R/C Button |
| 0B | Input | R/C Button | 79 | Ratio / Aspect Ratio | R/C Button |
| 0E | SLEEP | R/C Button | 91 | AD (Audio Description) | R/C Button |
| 0F | TV, TV/RAD | R/C Button | 7A | User Guide | R/C Button |
| 10 - 19 | Number Key 0 - 9 | R/C Button | 7C | Smart / Home | R/C Button |
| 1A | Q.View / Flashback | R/C Button | 7E | SIMPLINK | R/C Button |
| 1E | FAV (Favorite Channel) | R/C Button | 8E | ▶▶ (Forward) | R/C Button |
| 20 | Text (Teletext) | R/C Button | 8F | ◀◀ (Rewind) | R/C Button |
| 21 | T. Opt (Teletext Option) | R/C Button | AA | Info | R/C Button |
| 28 | Return (BACK) | R/C Button | AB | Program Guide | R/C Button |
| 30 | AV (Audio / Video) Mode | R/C Button | B0 | ▶ (Play) | R/C Button |
| 39 | Caption/Subtitle | R/C Button | B1 | ■ (Stop / Live TV) | R/C Button |
| 40 | ∧ (Arrow Key / Cursor Up) | R/C Button | BA | (Freeze / Slow Play / Pause) | R/C Button |
| 41 | V (Arrow Key / Cursor Down) | R/C Button | BD | ● (REC) | R/C Button |
| 42 | My Apps | R/C Button | DC | 3D | R/C Button |
| 43 | Menu / Settings | R/C Button | 9F | App / * | R/C Button |
| 44 | OK / Enter | R/C Button | | | |

- * Key code 4C (0x4C) is available on ATSC/ISDB models which use major/minor channel. (For South Korea, Japan, North America, Latin America except Colombia models)

EXTERNAL CONTROL DEVICE SETUP

- Image shown may differ from your TV.

Connect the USB to Serial converter/RS-232C input jack to an external control device (such as a computer or an A/V control system) to control the product's functions externally.

Note: The type of control port on the TV can be different between model series.

- * Please be advised that not all models support this type of connectivity.
- * Cable is not provided.

USB to Serial converter with USB Cable

USB Type

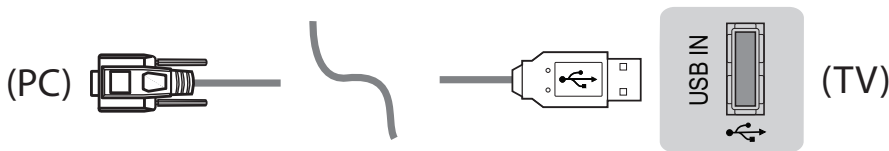

- LGTV supports PL2303 chip-based (Vendor ID : 0x0557, Product ID : 0x2008) USB to serial converter which is not made nor provided by LG.
- It can be purchased from computer stores that carry accessories for IT support professionals.

RS-232C with RS-232C Cable (Legacy)

Phone jack Type

- You need to purchase the phone-jack to RS-232 cable required for the connection between the PC and the TV, which is specified in the manual.
- * For other models, connect to the USB port.

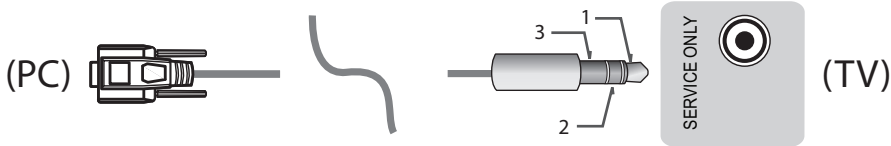

- This connection can only be used for the following models: 55/47/39LN5450-UA, 55/50/47/42LN5400-UA, 42/39/32LN5300-UA, and 37/32LN530B-UA.

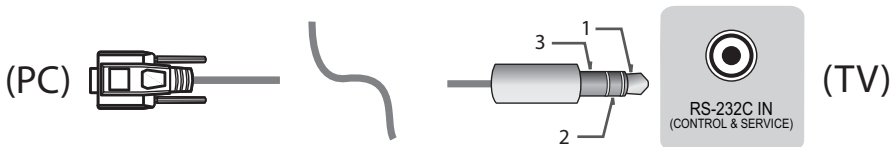

- This connection can only be used for the following models: 42/50PN4500-UA, 50/60PN5300-UF, 50/60PN6500-UA, and 60PN6550-UA.

Customer Computer

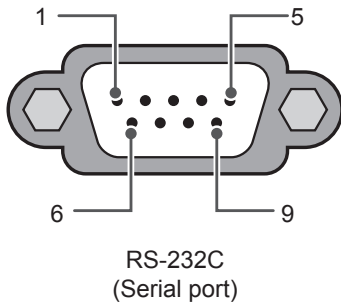

RS-232C configurations

3-Wire Configurations(Not standard)

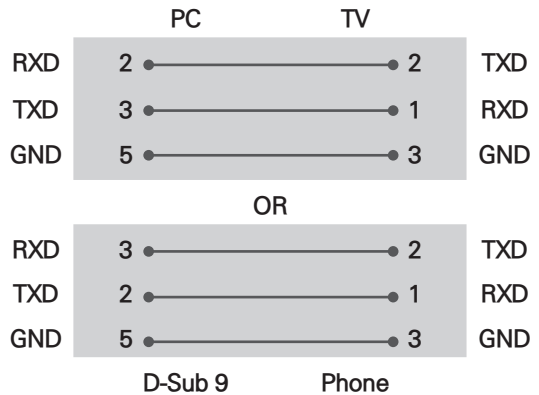

Set ID

For Set ID number, see "Real Data Mapping" on p.6

1. Press **SETTINGS** to access the main menus.
2. Press the Navigation buttons to scroll to **OPTION** and press **OK**.
3. Press the Navigation buttons to scroll to **SET ID** and press **OK**.
4. Scroll left or right to select a set ID number and select **CLOSE**. The adjustment range is 1-99.
5. When you are finished, press **EXIT**.

Communication Parameters

- Baud rate : 9600 bps (UART)
- Data length : 8 bits
- Parity : None
- Stop bit : 1 bit
- Communication code : ASCII code
- Use a crossed (reverse) cable.

Command reference list

(Depending on model)

| | COMMAND1 | COMMAND2 | DATA (Hexadecimal) | | COMMAND1 | COMMAND2 | DATA (Hexadecimal) |
|------------------------------|----------|----------|-----------------------|---------------------------------------------|----------|----------|-----------------------|
| 01. Power off | k | a | 00 | 13. Balance | k | t | 00 to 64 |
| 02. Aspect Ratio | k | c | (p.7) | 14. Color (Colour) Temperature | x | u | 00 to 64 |
| 03. Screen Mute | k | d | (p.7) | 15. ISM Method (Only Plasma TV) | j | p | (p.8) |
| 04. Volume Mute | k | e | 00 to 01 | 16. Energy Saving | j | q | 00 to 05 |
| 05. Volume Control | k | f | 00 to 64 | 17. Tune Command | m | a | (p.8) |
| 06. Contrast | k | g | 00 to 64 | 18. Channel (Programme) Add/Del(Skip) | m | b | 00 to 01 |
| 07. Brightness | k | h | 00 to 64 | 19. Key | m | c | Key Codes |
| 08. Color/ Colour | k | i | 00 to 64 | 20. Control Back Light, Control Panel Light | m | g | 00 to 64 |
| 09. Tint | k | j | 00 to 64 | 21. Input select (Main) | x | b | (p.10) |
| 10. Sharpness | k | k | 00 to 32 | 22. 3D (Only 3D models) | x | t | (p.11) |
| 11. OSD Select | k | l | 00 to 01 | 23. Extended 3D (Only 3D models) | x | v | (p.11) |
| 12. Remote Control Lock Mode | k | m | 00 to 01 | | | | |

* Note: During USB operations such as DivX or EMF, all commands except Power(ka) and Key(mc) are not executed and treated as NG.

Transmission / Receiving Protocol

Transmission

[Command1][Command2][][Set ID][][Data][Cr]

[Command 1] : First command to control the TV. (j, k, m or x)

[Command 2] : Second command to control the TV.

[Set ID] : You can adjust the [Set ID] to choose desired monitor ID number in option menu.

Adjustment range in TV is 1 to 99. If [Set ID] value is selected to '0', every connected set can be controlled.

* [Set ID] is indicated as decimal (1 to 99) on menu and as Hexadecimal (0x00 to 0x63) on transmission/receiving protocol.

[DATA] : To transmit command data (hexadecimal). Transmit 'FF' data to read status of command.

[Cr] : Carriage Return - ASCII code '0x0D'

[] : Space – ASCII code '0x20'

OK Acknowledgement

[Command2][][Set ID][][OK][Data][x]

* The set transmits ACK (acknowledgement) based on this format when receiving normal data. At this time, if the data is data read mode, it indicates present status data. If the data is data write mode, it returns the data of the PC computer.

Error Acknowledgement

[Command2][][Set ID][][NG][Data][x]

* The set transmits ACK (acknowledgement) based on this format when receiving abnormal data from non-viable functions or communication errors.

Data 00: Illegal Code

Real data mapping (Hexadecimal → Decimal)

* When you enter the [data] in hexadecimal, refer to following conversion table.

* Channel Tune (ma) Command uses two-byte hexadecimal value([data]) to select channel number.

| | | |
|--------------------------|--------------------------|-------------------|
| 00 : Step 0 | 32 : Step 50 (Set ID 50) | FE : Step 254 |
| 01 : Step 1 (Set ID 1) | 33 : Step 51 (Set ID 51) | FF : Step 255 |
| ... | ... | ... |
| 0A : Step 10 (Set ID 10) | 63 : Step 99 (Set ID 99) | 01 00 : Step 256 |
| ... | ... | ... |
| 0F : Step 15 (Set ID 15) | C7 : Step 199 | 27 0E : Step 9998 |
| 10 : Step 16 (Set ID 16) | C8 : Step 200 | 27 0F : Step 9999 |
| ... | ... | ... |

* Commands may work differently depending on model and signal.

01. Power (Command: k a)

- ▶ To control Power Off of the set.

Transmission [k][a][][Set ID][][Data][Cr]

Data 00 : Power Off

Ack [a][][Set ID][][OK/NG][Data][x]

- ▶ To Show Power On. (Works TV is On Only)

Transmission [k][a][][Set ID][][FF][Cr]

Ack [a][][Set ID][][OK][01][x]

* Similarly, if other functions transmit 'FF' data based on this format, Acknowledgement feedback presents status about each function.

02. Aspect Ratio (Command: k c) (Main Picture Size)

- ▶ To adjust the screen format. (Main picture format)
You can also adjust the screen format using the Aspect Ratio in the Q.MENU. or PICTURE menu.

Transmission [k][c][][Set ID][][Data][Cr]

| | |
|--------------------------------------------|------------------------------------------------------------------------|
| Data 01 : Normal screen (4:3) | 07 : 14:9 (Europe, Colombia, Mid-East, |
| 02 : Wide screen (16:9) | Asia except South Korea and Japan) |
| 04 : Zoom | 09 : * Just Scan |
| 05 : Zoom 2 | 0B : Full Wide |
| (Latin America except Colombia Only) | (Europe, Colombia, Mid- East, Asia except South Korea and Japan) |
| 06 : Set by Program/ Original | 10 to 1F : Cinema Zoom 1 to 16 |

Ack [c][][Set ID][][OK/NG][Data][x]

- * Using the PC input, you select either 16:9 or 4:3 screen aspect ratio.
- * In DTV/HDMI/Component mode (high-definition), Just Scan is available.
- * Full wide mode may work differently based on model and is supported for DTV fully, and ATV, AV partially.

03. Screen Mute (Command: k d)

- ▶ To select screen mute on/off.

Transmission [k][d][][Set ID][][Data][Cr]

Data 00 : Screen mute off (Picture on)
Video mute off
01 : Screen mute on (Picture off)
10 : Video mute on

Ack [d][][Set ID][][OK/NG][Data][x]

* In case of video mute on only, TV will display On Screen Display(OSD). But, in case of Screen mute on, TV will not display OSD.

04. Volume Mute (Command: k e)

- ▶ To control volume mute on/off.
You can also adjust mute using the MUTE button on remote control.

Transmission [k][e][][Set ID][][Data][Cr]

Data 00 : Volume mute on (Volume off)
01 : Volume mute off (Volume on)

Ack [e][][Set ID][][OK/NG][Data][x]

05. Volume Control (Command: k f)

- ▶ To adjust volume.
You can also adjust volume with the volume buttons on remote control.

Transmission [k][f][][Set ID][][Data][Cr]

Data Min : 00 to Max : 64

Ack [f][][Set ID][][OK/NG][Data][x]

06. Contrast (Command: k g)

- ▶ To adjust screen contrast.
You can also adjust contrast in the PICTURE menu.

Transmission [k][g][][Set ID][][Data][Cr]

Data Min : 00 to Max : 64

Ack [g][][Set ID][][OK/NG][Data][x]

07. Brightness (Command: k h)

- ▶ To adjust screen brightness.
You can also adjust brightness in the PICTURE menu.

Transmission [k][h][][Set ID][][Data][Cr]

Data Min : 00 to Max : 64

Ack [h][][Set ID][][OK/NG][Data][x]

08. Color/Colour (Command: k i)

- ▶ To adjust the screen Color(Colour).
You can also adjust colour in the PICTURE menu.

Transmission [k][i][][Set ID][][Data][Cr]

Data Min : 00 to Max : 64

Ack [i][][Set ID][][OK/NG][Data][x]

09. Tint (Command: k j)

- ▶ To adjust the screen tint.
You can also adjust tint in the PICTURE menu.

Transmission [k][j][][Set ID][][Data][Cr]

Data Red : 00 to Green : 64

Ack [j][][Set ID][][OK/NG][Data][x]

10. Sharpness (Command: k k)

- ▶ To adjust the screen sharpness.
You can also adjust sharpness in the PICTURE menu.

Transmission [k][k][][Set ID][][Data][Cr]

Data Min : 00 to Max : 32

Ack [k][][Set ID][][OK/NG][Data][x]

11. OSD Select (Command: k l)

- ▶ To select OSD (On Screen Display) on/off when controlling remotely.

Transmission [k][l][][Set ID][][Data][Cr]

Data 01 : OSD off 01 : OSD on

Ack [l][][Set ID][][OK/NG][Data][x]

12. Remote control lock mode (Command: k m)

- ▶ To lock the front panel controls on the monitor and remote control.

Transmission [k][m][][Set ID][][Data][Cr]

Data 01 : Lock off 01 : Lock on

Ack [m][][Set ID][][OK/NG][Data][x]

- * If you are not using the remote control, use this mode.
When main power is off & on (plug-off and plug-in, after 20 - 30 seconds), external control lock is released.
- * In the standby mode (DC off by off timer or 'ka', 'mc' command), and if key lock is on, TV will not turn on by power on key of IR & Local Key.

13. Balance (Command: k t)

- ▶ To adjust balance.
You can also adjust balance in the AUDIO menu.

Transmission [k][t][][Set ID][][Data][Cr]

Data Min : 00 to Max : 64

Ack [t][][Set ID][][OK/NG][Data][x]

14. Color(Colour) Temperature (Command: x u)

- ▶ To adjust colour temperature. You can also adjust Color(Colour) Temperature in the PICTURE menu.

Transmission [x][u][][Set ID][][Data][Cr]

Data Min : 00 to Max : 64

Ack [u][][Set ID][][OK/NG][Data][x]

15. ISM Method (Command: j p) (Only Plasma TV)

- ▶ To control the ISM method. You can also adjust ISM Method in OPTION menu.

Transmission [j][p][][Set ID][][Data][Cr]

Data Min : 02: Orbiter

08: Normal

20: Color(Colour) Wash

Ack [p][][Set ID][][OK/NG][Data][x]

16. Energy Saving (Command: j q)

- ▶ To reduce the power consumption of the TV. You can also adjust Energy Saving in PICTURE menu.

Transmission [j][q][][Set ID][][Data][Cr]

Data

00 : Off

01 : Minimum

02 : Medium

03 : Maximum

04 : Auto

05 : Screen off

- * (Depending on model)

Ack [q][][Set ID][][OK/NG][Data][x]

17. Tune Command (Command: m a)

- * This command may work differently depending on model and signal.
- For Europe, Mid-East, Colombia, Asia except South Korea and Japan, Model
- ▶ Select channel to following physical number.

Transmission [m][a][][Set ID][][Data 00][][Data 01][][Data 02][Cr]

- * Analogue Terrestrial/Cable

[Data 00][Data 01] Channel Data

Data 00 : High byte channel data

Data 01 : Low byte channel data
- 00 00 ~ 00 C7 (Decimal : 0 ~ 199)

Data 02 : Input Source (Analogue)

- 00 : Terrestrial TV (ATV)

- 80 : Cable TV (CATV)

* Digital Terrestrial/Cable/Satellite

[Data 00][Data 01]: Channel Data

Data 00 : High Channel data

Data 01 : Low Channel data

- 00 00 ~ 27 0F (Decimal: 0 ~ 9999)

Data 02 : Input Source (Digital)

- 10 : Terrestrial TV (DTV)

- 20 : Terrestrial Radio (Radio)

- 40 : Satellite TV (SDTV)

- 50 : Satellite Radio (S-Radio)

- 90 : Cable TV (CADTV)

- a0 : Cable Radio (CA-Radio)

* Tune Command Examples:

1. Tune to the analogue terrestrial (PAL) Channel 10.

Set ID = All = 00

Data 00 & 01 = Channel Data is 10 = 00 0a

Data 02 = Analogue Terrestrial TV = 00

Result = **ma 00 00 0a 00**

2. Tune to the digital terrestrial (DVB-T) Channel 01.

Set ID = All = 00

Data 00 & 01 = Channel Data is 1 = 00 01

Data 02 = Digital Terrestrial TV = 10

Result = **ma 00 00 01 10**

3. Tune to the satellite (DVB-S) Channel 1000.

Set ID = All = 00

Data 00 & 01 = Channel Data is 1000 = 03 E8

Data 02 = Digital Satellite TV = 40

Result = **ma 00 03 E8 40**

Ack [a][][Set ID][][OK][Data 00][Data 01]

[Data 02][x][a][][Set ID][][NG][Data 00][x]

- For South Korea, North/Latin America except Colombia Model

- ▶ To tune channel to following physical/major/minor number.

Transmission [m][a][][0][][Data00][][Data01]

[][Data02][][Data03][][Data04][][Data05][Cr]

Digital channels have a Physical, Major, and Minor channel number. The Physical number is the actual digital channel number, the Major is the number that the channel should be mapped to, and the Minor is the sub-channel. Since the ATSC tuner automatically maps the channel from the Major / Minor number, the Physical number is not required when sending a command in Digital.

* Analogue Terrestrial/Cable

Data 00 : Physical Channel Number

- Terrestrial (ATV) : 02~45 (Decimal: 2 ~ 69)

- Cable (CATV) : 01, 0E~7D (Decimal : 1, 14~125)

[Data 01 ~ 04]: Major/Minor Channel Number

Data 01 & 02: xx (Don't care)

Data 03 & 04: xx (Don't care)

Data 05: Input Source (Analogue)

- 00 : Terrestrial TV (ATV)

- 01 : Cable TV (CATV)

* Digital Terrestrial/Cable

Data 00 : xx (Don't care)

[Data 01][Data 02]: Major Channel Number

Data 01 : High byte Channel Data

Data 02 : Low byte Channel Data

- 00 01 ~ 27 0F (Decimal: 1 ~ 9999)

[Data 03][Data 04]: Minor Channel Number

Data 03 : High byte Channel Data

Data 04 : Low byte Channel Data

Data 05 : Input Source (Digital)

- 02 : Terrestrial TV (DTV) – Use Physical Channel Number

- 06 : Cable TV (CADTV) – Use Physical Channel Number

- 22 : Terrestrial TV (DTV) – Don't Use Physical Channel Number

- 26 : Cable TV (CADTV) - Don't Use Physical Channel Number

- 46 : Cable TV (CADTV) – Use Major Channel Number Only (One Part Channel)

Two bytes are available for each major and minor channel data, but usually the low byte is used alone (high byte is 0).

* Tune Command Examples:

1. Tune to the analogue cable (NTSC) channel 35.

Set ID = All = 00

Data 00 = Channel Data is 35 = 23

Data 01 & 02 = No Major = 00 00

Data 03 & 04 = No Minor = 00 00

Data 05 = Analogue Cable TV = 01

Total = **ma 00 23 00 00 00 01**

2. Tune to the digital terrestrial (ATSC) channel 30-3.

Set ID = All = 00

Data 00 = Don't know Physical = 00

Data 01 & 02 = Major is 30 = 00 1E

Data 03 & 04 = Minor is 3 = 00 03

Data 05 = Digital Terrestrial TV = 22

Total = **ma 00 00 00 1E 00 03 22**

Ack [a][][Set ID][][OK][Data 00][Data 01]

[Data 02][Data 03][Data 04][Data 05]

[x][a][][Set ID][][NG][Data 00][x]

- For Japan Model

- ▶ To tune channel to following physical/major/minor number.

Transmission [m][a][][0][][Data00][][Data01]

[][Data02][][Data03][][Data04][][Data05][Cr]

* Digital Terrestrial/Satellite

Data 00: xx (Don't care)

[Data 01][Data 02]: Major Channel Number

Data 01: High byte Channel Data

Data 02: Low byte Channel Data

- 00 01 ~ 27 0F (Decimal: 1 ~ 9999)

[Data 03][Data 04]: Minor/Branch Channel Number

(Don't care in Satellite)

Data 03: High byte Channel Data

Data 04: Low byte Channel Data

Data 05 : Input Source (Digital/Satellite for Japan)

- 02 : Terrestrial TV (DTV)

- 07 : BS (Broadcasting Satellite)

- 08 : CS1 (Communication Satellite 1)

- 09 : CS2 (Communication Satellite 2)

* Tune Command Examples:

1. Tune to the digital terrestrial (ISDB-T) channel 17-1.

Set ID = All = 00

Data 00 = Don't know Physical = 00

Data 01 & 02 = Major is 17 = 00 11

Data 03 & 04 = Minor/Branch is 1 = 00 01

Data 05 = Digital Terrestrial TV = 02

Total = **ma 00 00 00 11 00 01 02**

2. Tune to the BS (ISDB-BS) channel 30.

Set ID = All = 00

Data 00 = Don't know Physical = 00

Data 01 & 02 = Major is 30 = 00 1E

Data 03 & 04 = Don't Care = 00 00

Data 05 = Digital BS TV = 07

Total = **ma 00 00 00 1E 00 00 07**

* This feature is varied based on the model.

Ack [a][][Set ID][][OK][Data 00][Data 01]

[Data 02][Data 03][Data 04][Data 05]

[x][a][][Set ID][][NG][Data 00][x]

18. Channel(Programme) Add/Del(Skip)

(Command: m b)

► To skip current channel(programme) for next time.

Transmission [m][b][][Set ID][][Data][Cr]

Data 00 : Del(ATSC,ISDB)/Skip(DVB) 01 : Add

Ack [b][][Set ID][][OK/NG][Data][x]

* Set the saved channel status to del(ATSC, ISDB)/skip(DVB) or add.

19. Key (Command: m c)

► To send IR remote key code.

Transmission [m][c][][Set ID][][Data][Cr]

Data Key code - p.2.

Ack [c][][Set ID][][OK/NG][Data][x]

20. Control Back Light (Command: m g)

• For LCD TV / LED TV

► To control the back light.

Transmission [m][g][][Set ID][][Data][Cr]

Data Min : 00 to Max : 64

Ack [g][][Set ID][][OK/NG][Data][x]

Control Panel Light (Command: m g)

• For Plasma TV

► To control the panel light.

Transmission [m][g][][Set ID][][Data][Cr]

Data Min : 00 to Max : 64

Ack [g][][Set ID][][OK/NG][Data][x]

21. Input select (Command: x b)

(Main Picture Input)

► To select input source for main picture.

Transmission [x][b][][Set ID][][Data][Cr]

Data

00 : DTV 01 : CADTV

02 : Satellite DTV 10 : ATV

ISDB-BS (Japan)

03 : ISDB-CS1 (Japan)

04 : ISDB-CS2 (Japan)

11 : CATV

20 : AV or AV1

21 : AV2

40 : Component1

41 : Component2

90 : HDMI1

91 : HDMI2

92 : HDMI3

93 : HDMI4

Ack [b][][Set ID][][OK/NG][Data][x]

* This function depends on model and signal.

22. 3D(Command: x t) (only 3D models) (Depending on model)

- ▶ To change 3D mode for TV.

```
Transmission [x][t][ ][Set ID][ ][Data 00][ ][Data 01]
[ ][Data 02][ ][Data 03][Cr]
```

Data Structure

[Data 00] 00 : 3D On
01 : 3D Off
02 : 3D to 2D
03 : 2D to 3D

[Data 01] 00 : Top and Bottom
01 : Side by Side
02 : Check Board
03 : Frame Sequential
04 : Column interleaving
05 : Row interleaving

[Data 02] 00 : Right to Left
01 : Left to Right

[Data 03] 3D Effect(3D Depth): Min : 00 - Max : 14
(*transmit by Hexadecimal code)

- * If [Data 00] is 00 (3D On), [Data 03] has no meaning.
- * If [Data 00] is 01 (3D off) or 02 (3D to 2D), [Data 01], [Data 02] and [Data 03] have no meaning.
- * If [Data 00] is 03(2D to 3D), [Data 01] and [Data 02] have no meaning.
- * All 3D pattern options ([Data 01]) may not be available according to broadcasting/video signal.

| [Data 00] | [Data 01] | [Data 02] | [Data 03] |
|-----------|-----------|-----------|-----------|
| 00 | O | O | X |
| 01 | X | X | X |
| 02 | X | X | X |
| 03 | X | X | O |

X : don't care

```
Ack [t][ ][Set ID][ ][OK][Data00][Data01][Data02]
[Data03][x]
[t][ ][Set ID][ ][NG][Data00][x]
```

23. Extended 3D(Command: x v) (only 3D models) (Depending on model)

- ▶ To change 3D option for TV.

```
Transmission [x][v][ ][Set ID][ ][Data 00][ ]
[Data 01][Cr]
```

[Data 00] 3D option
00 : 3D Picture Correction
01 : 3D Depth (3D Mode is Manual Only)
02 : 3D Viewpoint
06 : 3D Color Correction
07 : 3D Sound Zooming
08 : Normal Image View
09 : 3D Mode (Genre)

[Data 01] It has own range for each 3D option determined by [Data 00].

- 1) When [Data 00] is 00
00 : Right to Left
01 : Left to Right
- 2) When [Data 00] is 01, 02
Data Min: 0 - Max: 14 (*transmit by Hexadecimal code)
Data value range(0 - 20) converts Viewpoint range (-10 - +10) automatically (Depending on model)
- 3) When [Data 00] is 06, 07, 08
00 : Off
01 : On
- 4) When [Data 00] is 09
00 : Standard 01 : Sport
02 : Cinema 03 : Extreme
04 : Manual

```
Ack [v][ ][Set ID][ ][OK][Data00][Data01][x]
[v][ ][Set ID][ ][NG][Data00][x]
```

