

OWNER'S MANUAL

Digital Video Recorder

Please read this manual carefully before operating your set and retain it for future reference.

MODELS

LRD5160 Series

LRD5080 Series



1

Safety Information



CAUTION

**RISK OF ELECTRIC SHOCK
DO NOT OPEN**



CAUTION: TO REDUCE THE RISK OF ELECTRIC SHOCK
DO NOT REMOVE COVER (OR BACK)
NO USER-SERVICEABLE PARTS INSIDE
REFER SERVICING TO QUALIFIED SERVICE PERSONNEL.



This lightning flash with arrowhead symbol within an equilateral triangle is intended to alert the user to the presence of uninsulated dangerous voltage within the product's enclosure that may be of sufficient magnitude to constitute a risk of electric shock to persons.



The exclamation point within an equilateral triangle is intended to alert the user to the presence of important operating and maintenance (servicing) instructions in the literature accompanying the product.

FCC WARNING: This equipment may generate or use radio frequency energy. Changes or modifications to this equipment may cause harmful interference unless the modifications are expressly approved in the instruction manual. The user could lose the authority to operate this equipment if an unauthorized change or modification is made.

REGULATORY INFORMATION: FCC Part 15

This equipment has been tested and found to comply with the limits for a Class A digital device, pursuant to Part 15 of the FCC Rules. These limits are designed to provide reasonable protection against harmful interference when the equipment is operated in a commercial environment.

This equipment generates, uses, and can radiate radio frequency energy and, if not installed and used in accordance with the instruction manual, may cause harmful interference to radio communications.

Operation of this equipment in a residential area is likely to cause harmful interference in which case the user will be required to correct the interference at his own expense.

- A suitable conduit entries, knock-outs or glands shall be provided in the cable entries of this product in the end user.
- Caution: Danger of explosion if battery is incorrectly replaced. Replaced only with the same or equivalent type recommended by the manufacturer. Dispose of used batteries according to the manufacturer's instructions.
- Holes in metal, through which insulated wires pass, shall have smooth well rounded surfaces or shall be provided with brushings.

This Class A digital apparatus complies with Canadian ICES-003. Cet appareil numérique de la classe A est conforme à la norme NMB-003 du Canada.

Warning: Do not install this equipment in a confined space such as a bookcase or similar unit.

Warning: Wiring methods shall be in accordance with the National Electric Code, ANSI/NFPA 70.

Warning: This is a class A product. In a domestic environment this product may cause radio interference in which case the user may be required to take adequate measures.

Warning: To reduce a risk of fire or electric shock, do not expose this product to rain or moisture.

Caution: This installation should be made by a qualified service person and should conform to all local codes.

Caution: To avoid electrical shock, do not open the cabinet. Refer servicing to qualified personnel only.

Caution: The apparatus should not be exposed to water (dripping or splashing) and no objects filled with liquids, such as vases, should be placed on the apparatus.

Caution:

This product employs a Laser System. To ensure proper use of this product, please read this owner's manual carefully and retain it for future reference. Should the unit require maintenance, contact an authorized service center. Use of controls, adjustments, or the performance of procedures other than those specified herein may result in hazardous radiation exposure. To prevent direct exposure to laser beam, do not try to open the enclosure.

To disconnect power from mains, pull out the mains cord plug. When installing the product, ensure that the plug is easily accessible.



LG Electronics hereby declares that this/these product(s) is/are in compliance with the essential requirements and other relevant provisions of Directive 2004/108/EC, 2006/95/EC, and 2011/65/EU.

Contact office for compliance of this product :

LG Electronics Inc.
EU Representative, Krijgsman 1,
1186 DM Amstelveen, The Netherlands

- Please note that this is NOT a Customer Service contact point. For Customer Service Information, see Warranty Card or contact the dealer that you purchased this product.

Disposal of your old appliance



1. When this crossed-out wheeled bin symbol is attached to a product it means the product is covered by the European Directive 2002/96/EC.
2. All electrical and electronic products should be disposed of separately from the municipal waste stream via designated collection facilities appointed by the government or the local authorities.
3. The correct disposal of your old appliance will help prevent potential negative consequences for the environment and human health.
4. For more detailed information about disposal of your old appliance, please contact your city office, waste disposal service or the shop where you purchased the product.

EEE Compliance with Directive. (for Turkey only)

Safety way to remove the battery or the battery from the equipment:

Remove the old battery or battery pack, follow the steps in reverse order than the assembly. To prevent contamination of the environment and bring on possible threat to human and animal health, the old battery or the battery put it in the appropriate container at designated collection points. Do not dispose of batteries or battery together with other waste. It is recommended that you use local, free reimbursement systems batteries and accumulators. The battery shall not be exposed to excessive heat such as sunshine, fire or the lile.

Disposal of waste batteries/accumulators



1. When this crossed-out wheeled bin symbol is attached to batteries/accumulators of Your product it means they are covered by European Directive 2006/66/EC.
2. This symbol may be combined with chemical symbols for mercury(Hg), cadmium(Cd) or lead(Pb) if the battery Contains more that 0.0005% of mercury, 0.002% of cadmium or 0.004% of lead.
3. All batteries/accumulators should be disposed separately from the municipal waste stream via designated collection facilities appointed by the government or the local authorities.
4. The correct disposal of Your old batteries/ accumulators will help to prevent potential negative consequences for the environment, animal and human health.
5. For more detailed information about disposal of Your old batteries/accumulators, please contact Your city office, waste disposal service or the shop where You purchased the product.

IMPORTANT SAFETY INSTRUCTIONS

1. Read these instructions.
 2. Keep these instructions.
 3. Heed all warnings.
 4. Follow all instructions.
 5. Do not use this apparatus near water.
 6. Clean only with dry cloth.
 7. Do not block any ventilation openings. Install in accordance with the manufacturer's instructions.
 8. Do not install near any heat sources such as radiators, heat registers, stoves, or other apparatus (including amplifiers) that produce heat.
 9. Do not defeat the safety purpose of the polarized or grounding-type plug. A polarized plug has two blades with one wider than the other. A grounding type plug has two blades and a third grounding prong. The wide blade or the third prong are provided for your safety. If the provided plug does not fit into your outlet, consult an electrician for replacement of the obsolete outlet.
 10. Protect the power cord from being walked on or pinched particularly at plugs, convenience receptacles, and the point where they exit from the apparatus.
 11. Only use attachments/accessories specified by the manufacturer.
 12. Use only with the cart, stand, tripod, bracket, or table specified by the manufacturer, or sold with the apparatus. When a cart is used, use caution when moving the cart/apparatus combination to avoid injury from tip-over.
- 
13. Unplug this apparatus during lightning storms or when unused for long periods of time.
 14. Refer all servicing to qualified service personnel. Servicing is required when the apparatus has been damaged in any way, such as power-supply cord or plug is damaged, liquid has been spilled or objects have fallen into the apparatus, the apparatus has been exposed to rain or moisture, does not operate normally, or has been dropped.

Safety warnings and Cautions

The following are warnings and cautions for the safety of the users and for the prevention of any property damage. Please read the following carefully.

WARNING

- Turn off the system before installation. Do not plug in several electric devices to the same outlet.
 - This may cause heating, fire, or electric shock.
- Do not place any liquid container on the system, such as water, coffee, or other beverage.
 - If liquid is poured onto the system, it can cause a system breakdown or fire.
- Prevent the power cable from being severely bent or having pressure exerted on it by a heavy object.
 - This may cause fire.
- Clean the dust around the system on a regular basis. When cleaning the system, always use a dry cloth. Do not use a wet cloth or other organic solvents.
 - This may damage the surface of the system and can cause a system breakdown or electric shock.
- Avoid any place with moisture, dust, or soot.
 - This can cause fire or electric shock.
- When pulling the power cable from the plug, do so gently. Do not touch the plug with wet hands and avoid using the plug if the holes in the outlet are too loose.
 - This may cause fire or electric shock.
- Do not attempt to disassemble, repair, or modify the system on your own. It is extremely dangerous due to the high voltage running through the system.
 - This may cause fire, electric shock, or serious injury.
- Check for any danger signs such as a moist floor, a loosened or damaged power cable, or an unstable surface. If you encounter any problems, ask your dealer for assistance.
 - This may cause fire or electric shock.
- Keep a distance of at least 15 cm between the back of the system and the wall for the cables connected to the system otherwise, they may be bent, damaged, or cut.
 - This may cause fire, electric shock, or injury.
- Install the system in a cool place without direct sunlight and always maintain room temperature. Avoid candlelight and heat generating devices such as heaters. Keep the system away from places where many people pass.
 - This may cause fire.
- Install the system on a plain surface with sufficient air ventilation. Do not place the system on an elevated surface.
 - This may cause system breakdown or serious injury.
- The power outlet must be placed on the ground, and the voltage range must be within 10 % of the voltage rate. Do not use the same outlet with a hair dryer, iron, refrigerator, or any heating appliances.
 - This may cause fire, over heating or electric shock.
- When the system's battery is depleted, replace it with the same or equivalent type of battery specified by the manufacturer. Depleted batteries should be discarded according to the manufacturer's instructions.
 - This may cause an explosion.
- If the system's HDD exceeds its life span, you may not be able to recover any data stored inside the HDD. If the video on the system screen appears 'damaged' while playing a recording stored inside the system's HDD, it must be replaced with a new one. Ask for an engineer's assistance for HDD replacement from your dealer.
 - LG Electronics is not responsible for deleted data caused by user mishandling.
- PLEASE DO NOT MOUNT OR UN-MOUNT HDDs WHILE SYSTEM IS POWERED ON.
 - This may cause system breakdown.

CAUTION

Please beware of the following precautions before installing the DVR.

- Avoid positioning the product in any place where the unit may come into contact with moisture, dust, or soot.
- Avoid placing in direct sunlight or near heating appliances.
- Keep the product away from electric sparks or magnetic substances.
- Do not place any conductive material through the ventilation grills.
- Keep the system turned off before installation.
- Ensure enough space is left for cable connections.
- Place the system on a solid surface with sufficient air ventilation. Avoid any surface that vibrates.
- Placing the system near electronic devices such as a radio or a TV may cause the product to breakdown.
- Do not disassemble the product without seeking assistance from LG Electronics.
- Do not place any heavy object on the system.
- Prevent any substances from being inserted into the system.
 - This may cause system breakdown.
- Install the system in a place with sufficient air ventilation.
 - Keep at least 15 cm distance between the back of the system and the wall, and at least 5 cm distance between the side of the system and the wall.
- Do not install the system in a place with high magnetic, electric wave, or wireless devices such as a radio or a TV.
 - Do not install the system in a place with magnetic objects, electric frequencies, or vibration.
- Do not place any heavy object on the system.
 - This may cause system breakdown.
- Install the system on a stable, level surface.
 - The system may not operate properly.
- Install the system in a place with appropriate moisture and temperature levels.
 - Avoid installing the system in a place with high (over 40 °C) or low (under 0 °C) temperature.
- The system can be damaged from a strong impact or vibration. Avoid throwing objects within the vicinity of the system.
- Avoid direct sunlight or any heating appliances.
 - Recommended operating temperature is over 0 °C (32 °F).
- Ventilate the air inside the system operation room, and tighten the system cover firmly.
 - System breakdown may be caused by an inappropriate environment. It is recommended to use AVR (Automatic Voltage Regulator) for a stable power supply. It is recommended to coil the core-ferrite around the connector of the system to avoid electromagnetic interference.
- The outlet must be placed on the ground.
- If there is strange sound or smell, unplug the power cable immediately and contact the service center.
 - This may cause fire or electric shock.
- In order to maintain stable system performance, have your system checked regularly by the service center.
 - LG Electronics is not held responsible for system breakdown caused by user mishandling.
 - There is a risk of explosion if a battery is replaced by an incorrect type. Dispose of used batteries according to the instructions.
- Do not overturn the product during use.

Contents

1

Safety Information

- 3 IMPORTANT SAFETY INSTRUCTIONS

2

Preparation

- 8 Introduction
- 8 Features
- 8 Accessories
- 9 Front Panel
- 11 Rear Panel
- 12 Remote Control

3

Installation

- 13 Connections
 - 13 Precautions
 - 13 Basic Connection Overview
 - 14 Connecting Camera
 - 14 Connecting the video distributor
 - 14 Connecting Display device
 - 15 Connecting Audio device
 - 15 Connecting USB device
 - 15 Connecting E-SATA device
 - 16 Connecting ATM/POS
 - 16 Connecting Network
 - 17 Connecting RS-485 device
 - 17 Connecting Alarm Input and Alarm Output
- 19 HDD INSTALLATION
 - 19 Note for Hard Disk Drive
 - 19 Installing the Hard Disk Drive
 - 19 Replacing the Hard Disk Drive
 - 19 Recommended HDD
- 20 System Operation
- 20 System Shutdown
- 20 General Explanation of the Live

Screen on the Main Monitor

- 20 Main Monitor Screen
- 21 Moving the Channel's Position
- 21 Selecting the Main Monitor screen mode
- 22 Selecting the Spot Monitor screen mode
- 22 Grouping channels
- 22 PTZ Camera Control
- 23 Using the Digital Zoom function
- 24 Export the recorded data
- 25 Viewing the System Log List
- 25 Viewing System Information
- 26 Configuration menu
- 27 System settings
 - 27 Properties
 - 27 TCP/IP v4
 - 27 TCP/IP v6
 - 28 Network
 - 28 Network Streaming
 - 29 Date/Time
 - 29 NTP
 - 29 Controller
 - 29 Update
 - 30 Backup
- 31 Device settings
 - 31 Camera
 - 31 PTZ
 - 32 ATM/POS
 - 32 Storage
- 33 Display settings
 - 33 OSD
 - 33 Sequence
 - 33 Video Adjustment
- 34 Record settings
 - 34 Normal Schedule Recording
 - 34 To Set a Recording Schedule for a Typical Day of the Week (Normal Schedule)
 - 35 To Set a Recording Schedule for a Special Day (Special Schedule)
 - 35 Copying the Recording Schedule
 - 36 Normal
 - 36 Sensor
 - 36 Motion
 - 36 Text
 - 37 Instant/Panic
- 37 Event settings
 - 37 Sensor
 - 37 Motion
 - 38 ATM/POS Data Format
 - 38 Event Popup

39	Notification	56	Factory Default Configuration Settings
39	Mail	62	Recording Time Table (250GB HDD)
39	Emergency	65	Specifications
40	SNMP		
40	Output		
41	Buzzer		
41	User settings		
41	Group Authority		
42	User		
42	Setup Wizard settings		
42	Step 1		
43	Step 2		
43	Step 3		
43	Step 4		
43	Step 5		

4 Operation

44	Instant Recording
44	Panic Recording
45	Instant Playback
45	Search and Playback
45	Date and Time Search
45	Event Search
46	Bookmark/Protect Search
46	ATM/POS Search
47	Export Search
47	Smart Search
48	Functions Available During Playback
49	Using the playback control menu
49	Using the Protect function

5 Troubleshooting

6 Appendix

53	Recommended Devices
53	Recommended USB Memory list
53	Recommended External Device list
53	Supported function list for device
54	Supported PTZ Camera list
55	Time zones

2 Preparation

Introduction

Model LRD5160 (16 Channel) is used for the description, operation and details provided in this operating guide.

Features

- Stable embedded Linux operating system.
- Journal filing system for HDD file recovery following power recovery.
- Small file sizes with H.264 compression.
- Internal storage expandable to 8 TB. (Expandable if new high capacity HDD is launched)
- NTSC and PAL selectable video format.
- Full real-time recording.

NTSC	Up to 480 IPS @ 352x240, LRD5160 Series Up to 240 IPS @ 352x240, LRD5080 Series
PAL	Up to 400 IPS @ 352x288, LRD5160 Series Up to 200 IPS @ 352x288, LRD5080 Series









- Various recording resolutions and quality levels.

NTSC	D1(704x480), Half D1(704x240), CIF(352x240)
PAL	D1(704x576), Half D1(704x288), CIF(352x288)

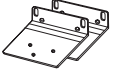
- 5 step quality level (Highest, High, Standard, Low, Lowest).
- Easy operation using various user interface & user friendly GUI.
 - Optical mouse, Full function IR remote controller
- Powerful multiplex function.
 - Simultaneous live display, recording, playback, network transmission, back-up.
- Various search function.
 - Date/time search (calendar search), Event search, Bookmark/Protect search, ATM/POS search, Export search, Smart search.
- Pre-alarm recording (Up to 1 minute).
- Motion event recording and preview test function of motion sensitivity.
- Recording image rate & quality adjustment per individual camera.
- Powerful record scheduling.
- Instant playback in live mode.
- Perfect audio/video synchronization.
- Automatic backup by schedule.
- Image authentication (Watermark).
- Three USB 2.0 ports for backup interface.

- Setup configuration export/import with USB memory stick.
- Easy system S/W update with USB memory stick or network.
- Clients S/W can manage max 300 DVR servers.
- Max five clients can access one DVR server simultaneously.
- Network bandwidth throttle.
 - Automatically adjust a bandwidth according to network speed status of unit.
- Remote alarm notification via client software or E-mail.
- Time and date sync from NTP server.
- Daylight saving mode.
- Covert camera protection.
- Support Gigabit Ethernet.
- E-SATA storage interface.
- Two-way audio.
- Text Input for ATM and POS device.
- User management (User level control).
- PTZ Control.
 - Dome camera telemetry control (Dome OSD control).

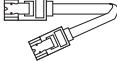
Accessories

CD (Software and Owner's Manual)		Screws	
Mouse		Rack Mount Bracket	
Remote Control		Power Plug	
AAA type batteries		SATA cable(s)	
Simple Manual			

Front Panel

Front of the LRD5160 series

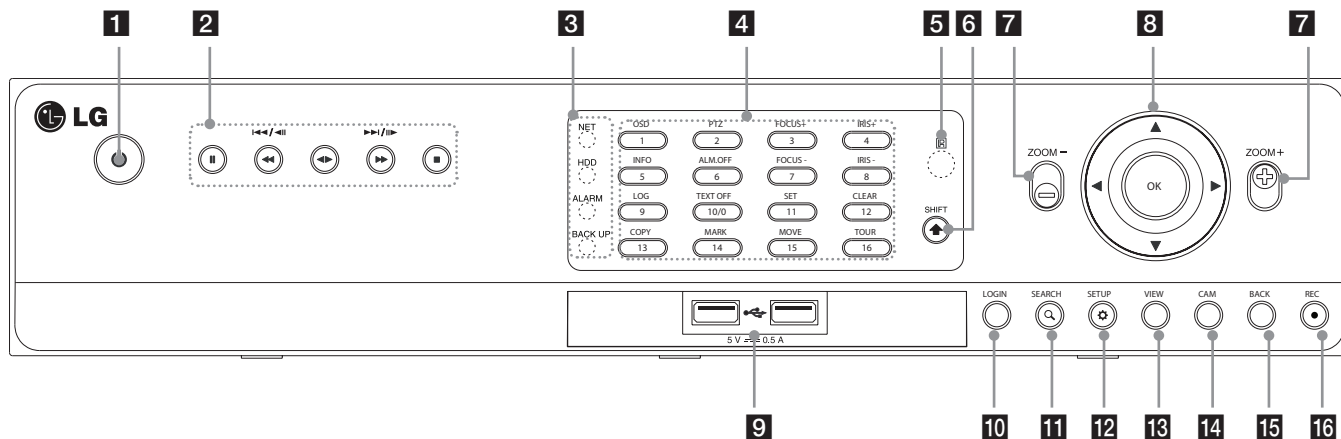

Front of the LRD5080 series

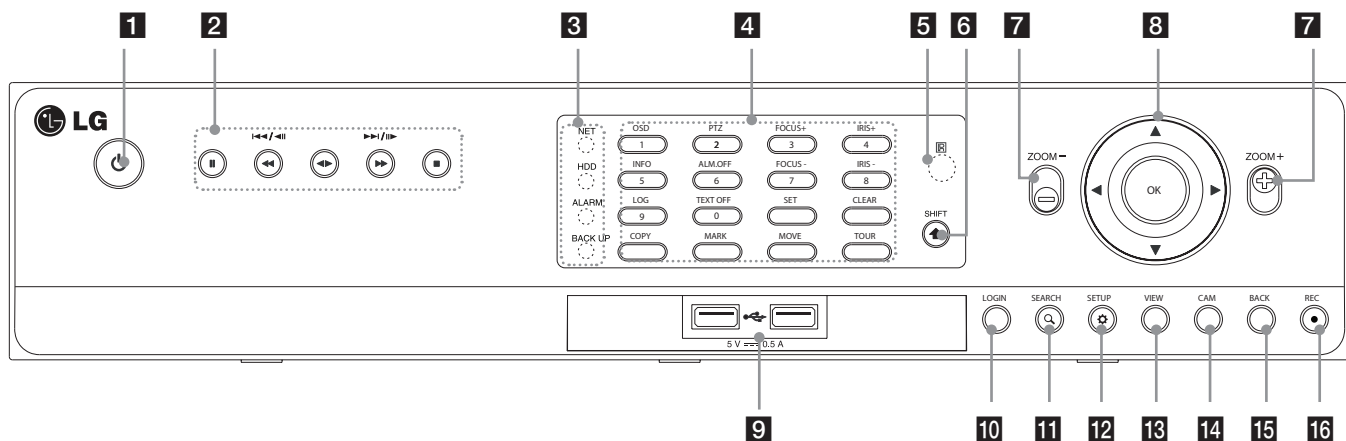

- 1** (Power): Turns DVR on or off. Press and hold for more than 2 seconds to turn on or off.
- 2** Playback Control Buttons
 - : Pauses playback.
 - : Searches the recorded images in reverse or skips the recorded images.
 - : Playback or reverse playback of recorded images.
 - : Forward searches the recorded images or skips the recorded images.
 - : Stops playback.
- 3** Indicator
 - NET: Blinks when the network is connected.
 - HDD: Lights when the HDD is accessed.
 - ALARM: Lights when the alarm out is in progress.
 - BACK UP: Lights when the data back up is in progress.

4 Channel Buttons: You can input a number with channel buttons. You can also use the channel buttons for sub-function with SHIFT button (11 to 16 buttons of 8 channel DVR are used for sub-function without SHIFT button.). You should press the OK button after input the channel number when you select the applicable channel.

- The LED in the button indicates the status as follows:
 - Off: The current status is for live mode.
 - Red: Recording mode.
 - Blinks when an event occurs.
- Sub-functions

Button number	Function	Description
1	OSD	Accesses or minimizes the System Control Bar (OSD).
2	PTZ	Switches this unit to PTZ mode to control the connected PTZ camera.
3/7	FOCUS - / FOCUS +	Adjusts focus position.
4/8	IRIS - / IRIS +	Adjust iris position.
5	INFO	Displays the system information.
6	ALM.OFF	Cancels alarm activation and returns the system to the condition before the alarm was activated.
9	LOG	Displays the System Log List.
10	TEXT OFF	Displays or disappears the text information if the recording data includes text data.
11	SET	Registers the PTZ camera's preset position.
12	CLEAR	Deletes a memorized preset position.
13	COPY	Displays the export menu.
14	MARK	Sets the mark point for recording search.
15	MOVE	Moves the camera to the preset position.
16	TOUR	Tours all registered preset positions in the camera.

5 Remote Sensor: Point the remote control here.

6 SHIFT button: If you use the Sub-function of the channel button, the button is activated.

7 ZOOM + / -: Zooms in/out on playback window.

8 Arrow and OK Buttons

- ▲▼◀▶: Select or move between the menu options.
- OK: Confirms menu selections.

9 USB Port: Connects an external USB device for backup or playback.

10 LOG-IN: Displays the User Log-In dialog box or logs out.

11 SEARCH: Displays the search menu.

12 SETUP: Displays the setup menu.

13 VIEW: Displays the split mode menu for MAIN Monitor and SPOT Monitor.

14 CAM: Displays the Monitor menu to set the first camera channel.

15 BACK: Exits the menu or returns to the previous screen.

16 REC: Starts or stops instant recording.

Rear Panel

Rear of the LRD5160 series

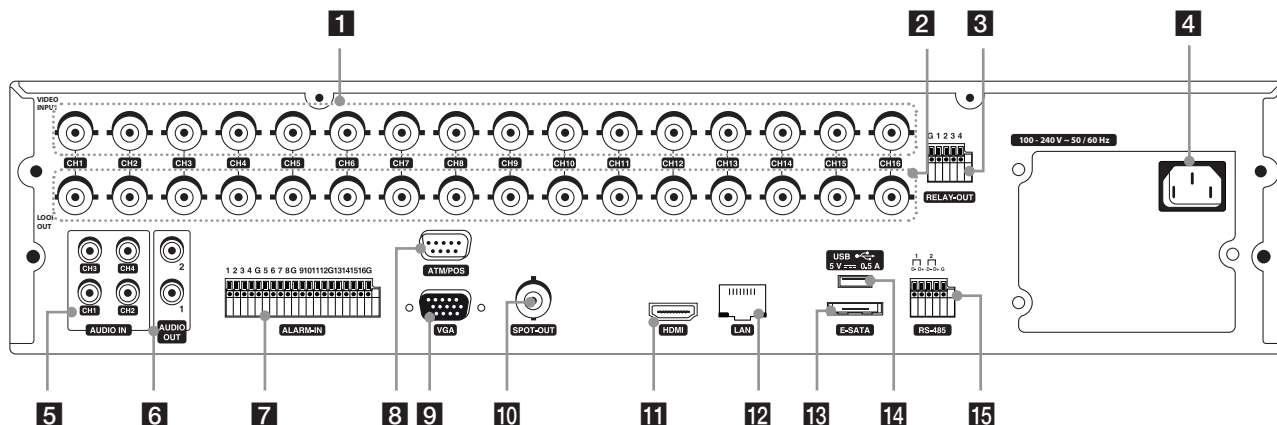

Rear of the LRD5080 series

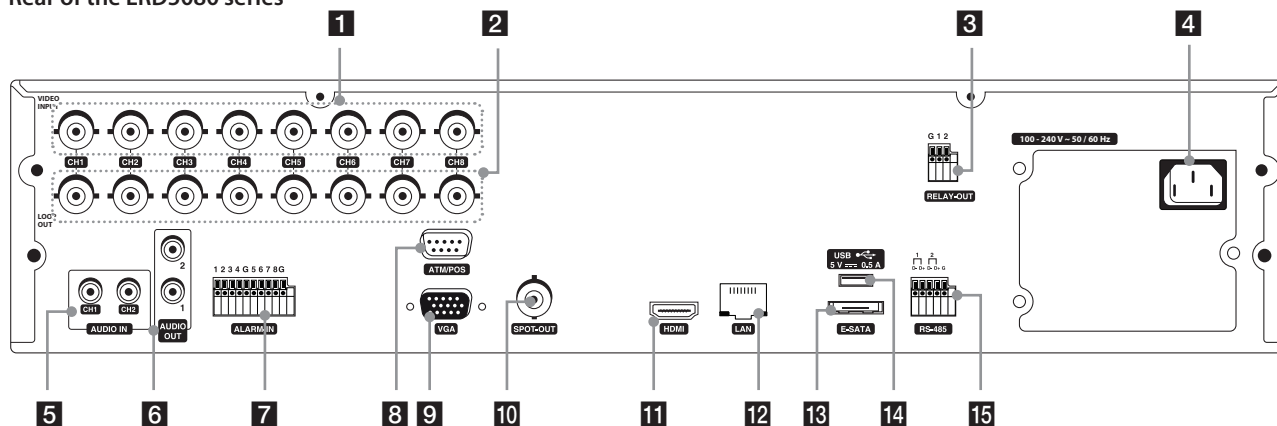

- 1** VIDEO INPUT: Connect the camera's video output to these BNC connectors.
- 2** LOOP OUT: The signal from VIDEO INPUT connector is looped out to this connector.
- 3** RELAY-OUT Terminals: Output terminals for alarm (relay) signal.
- 4** Power Cord Inlet (AC IN): Connect the power plug.
- 5** AUDIO IN: Connect the audio output of an external device.
- 6** AUDIO OUT 1 / 2: Connect to an active speaker with a built-in amplifier.
- 7** ALARM-IN Terminals: Input terminals for alarm (relay) signal.
- 8** ATM/POS: Used to connect to a ATM/POS device.
- 9** VGA: Connect a VGA monitor.
- 10** SPOT-OUT (BNC Type Connector): Connect to spot monitor or display device.
- 11** HDMI: Connect to monitor or display device with HDMI inputs. (Interface for digital audio and video)
- 12** LAN Ports: Connect the ethernet 10/100/1000 Mbps network cable for controlling this unit via a PC network.
- 13** E-SATA: Connect the external SATA device.
- 14** USB Port: Connect an optional extension USB device.
- 15** RS-485 Terminals: Connect RS-485 compatible cameras.

Remote Control

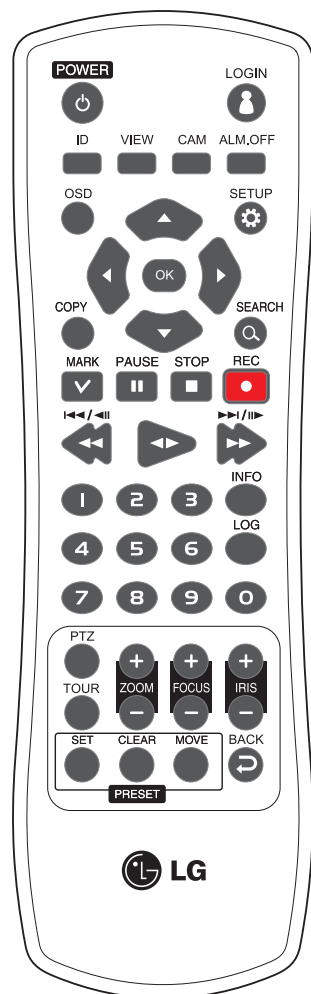

Button	Description
POWER (⏻)	Turns DVR on or off.
LOGIN	Displays the User Log-In dialog box or logs out.
ID	Set the appropriate DVR system ID to operate via the IR Remote Controller when using the multiple DVR. Press the ID button then press the number button within 2 seconds to select the system ID of the DVR. If you set the system ID to "0", you can control multiple DVR at the same time.
VIEW	Displays the split mode menu for MAIN Monitor and SPOT Monitor.
CAM	Displays the Monitor menu to set the first camera channel.
ALM.OFF	Cancels alarm activation and returns the system to the condition before the alarm was activated.
OSD	Accesses or minimizes the system control bar.
SETUP	Displays the setup menu.
▲▼◀▶	Selects or moves between the menu options.
OK	Confirms menu selections.
COPY	Copies the recording data to an external device.
SEARCH	Displays the search menu.
MARK	Sets the mark point for recording search. You can set the mark point during the single or multi channel playback of recorded data.
PAUSE (⏸)	Pauses playback.
STOP (■)	Stops playback.
REC (●)	Starts or stops recording.
◀◀, ◀◀/◀◀	Searches the recorded images in reverse or skips the recorded images.
◀◀	Playback or reverse playback of recorded images.
▶▶, ▶▶/▶▶	Forward searches the recorded images or skips the recorded images.
Number Buttons	Selects the PTZ preset number, ID or channel.
INFO	Displays the system information window.
LOG	Displays the System Log List window.
PTZ	Switches this unit to PTZ mode to control the connected PTZ camera.
TOUR	Tours all registered preset positions in the camera.
ZOOM + / -	Zooms in/out on the playback window. If you press ZOOM(+) button during viewing a live channel in full screen mode or playing back a channel in full screen mode, the digital zoom function is activated.
FOCUS + / -	Adjusts the focus of a camera.
IRIS + / -	Adjusts the iris of a camera.
SET	Registers the PTZ camera's preset positions.
CLEAR	Deletes a memorized preset position.
MOVE	Moves the camera to the preset position.
BACK	Exits the menu or returns to the previous screen.

3 Installation

Connections

Precautions

- Depending on the camera and other equipment there are various ways to connect the unit. Please refer to the camera manual or manuals for other devices as necessary for additional connection information.
- Be sure to switch off the camera before installation and connection.

Basic Connection Overview

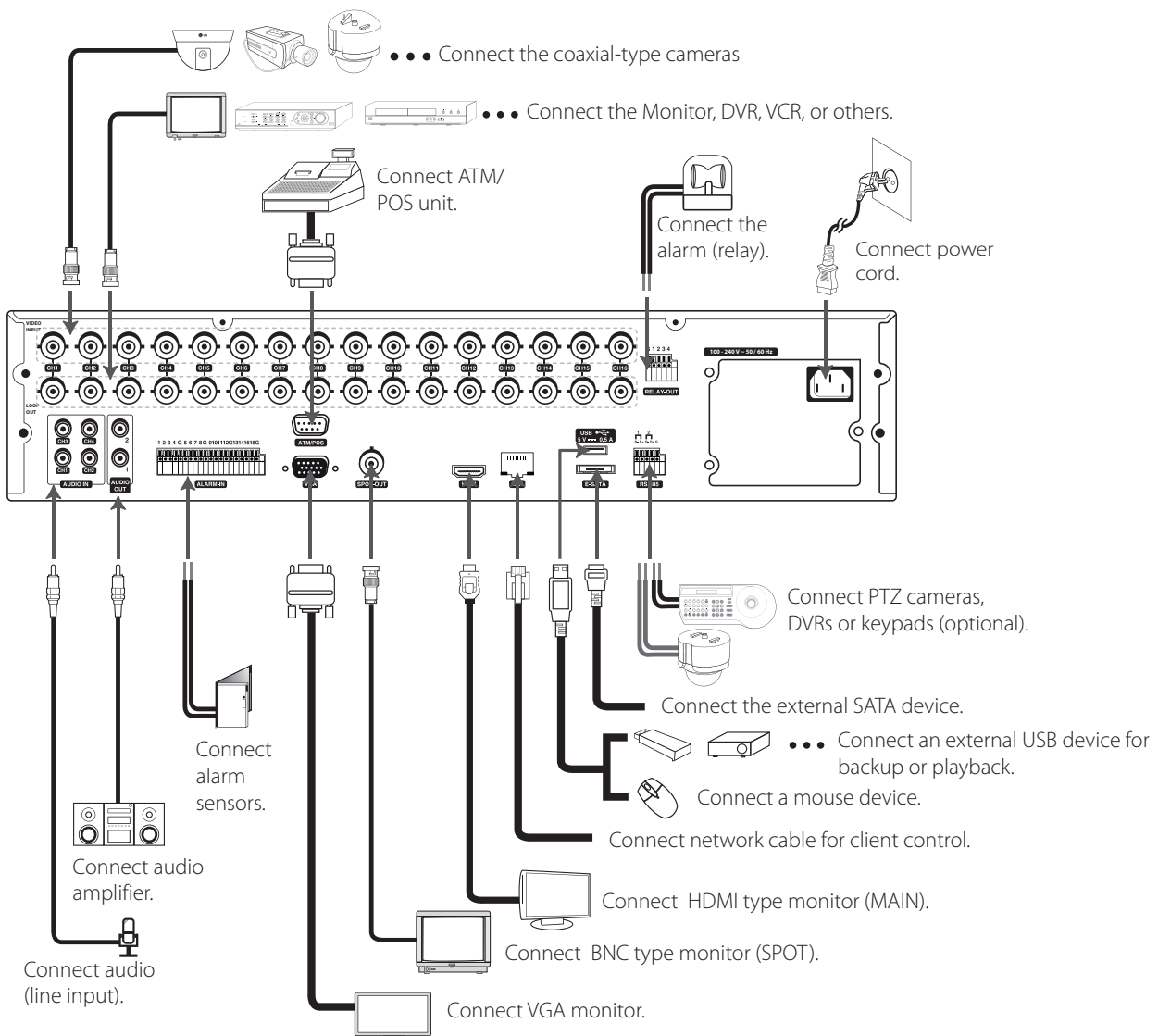

Connecting Camera

Connect the video output of your camera to the unit, using a standard 75 Ω video coaxial cable with BNC connector. LOOF OUT connector passes the video signal from VIDEO INPUT connector to connect to other device.

Camera connection

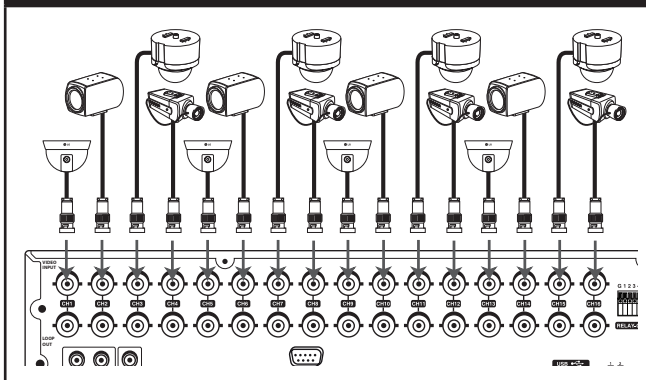

NOTE

If the distance between the camera and DVR is too long, the noise may be generated. In this case, we recommend you to ground DVR's power and not to ground camera's power.

Connecting the video distributor

Connect the video signal of the camera to the input connector of the video distributor using a 75 Ω video coaxial cable with BNC connector. Connect the video output of the video distributor to the VIDEO INPUT connector of DVR using a using a 75 Ω video coaxial cable with BNC connector. Connect your monitor to the video output connector of the video distributor.

Connecting the video distributor

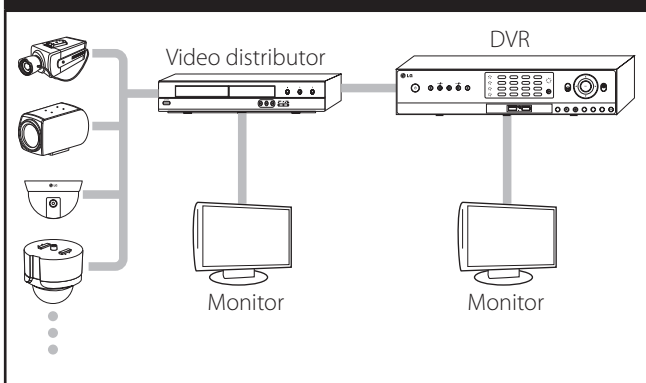

NOTE

- If the cable's length is too long, DVR's parts may be damaged due to an external static electricity. Before connecting the video cable, touch the end of the cable to DVR's case to avoid the risk of static buildup.
- Please check the images via a monitor after installation of the video distributor.

Connecting Display device

This unit can be output simultaneously from the HDMI, VGA and SPOT OUT jack. The video signal connection between the DVR and the monitor.

VGA Monitor connection

Connect the VGA jacks on the rear of the unit to the corresponding input jacks on the TV or monitor using the VGA cable.

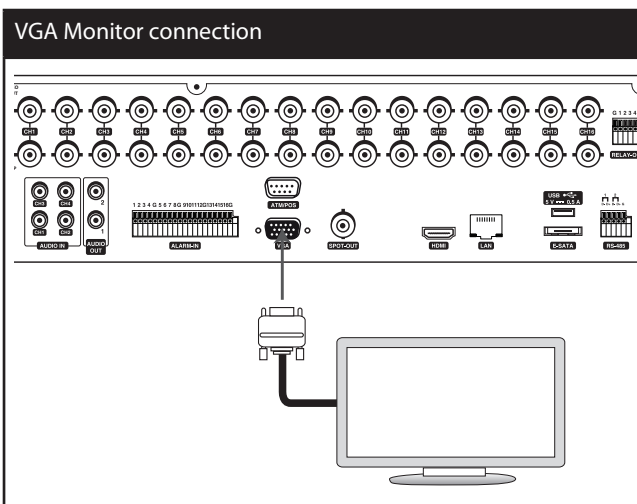

SPOT Monitor connection

Connect the unit to the SPOT monitor using 75 Ω video coaxial cables with BNC connector.

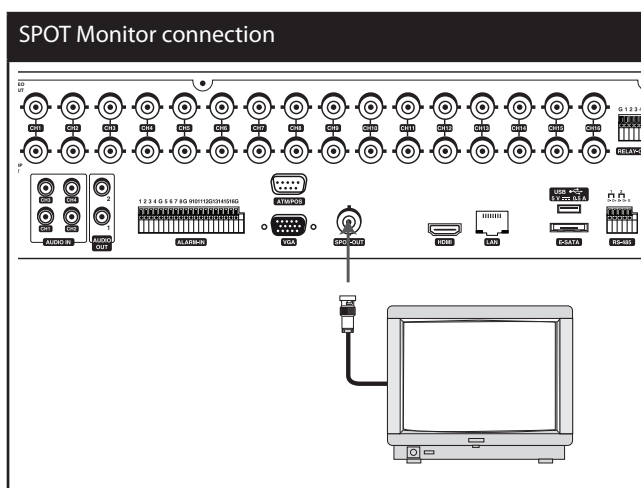

HDMI Monitor connection

Connect the unit to the HDMI monitor using a HDMI cable (Type A, High Speed HDMI™ Cable).

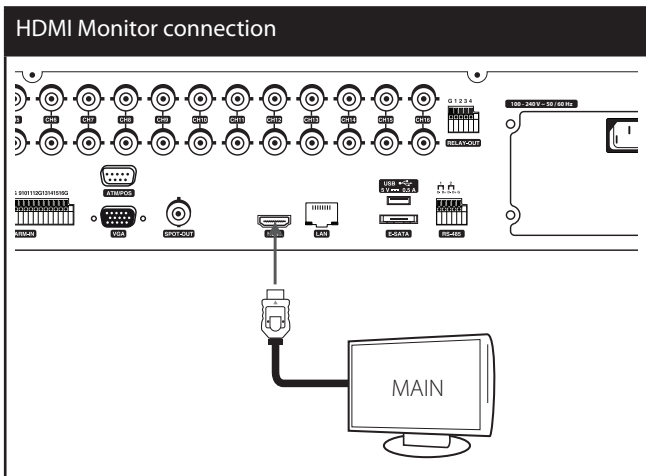

Connecting Audio device

Connect the AUDIO OUT jacks on the unit to the mono audio in jacks on your audio device.

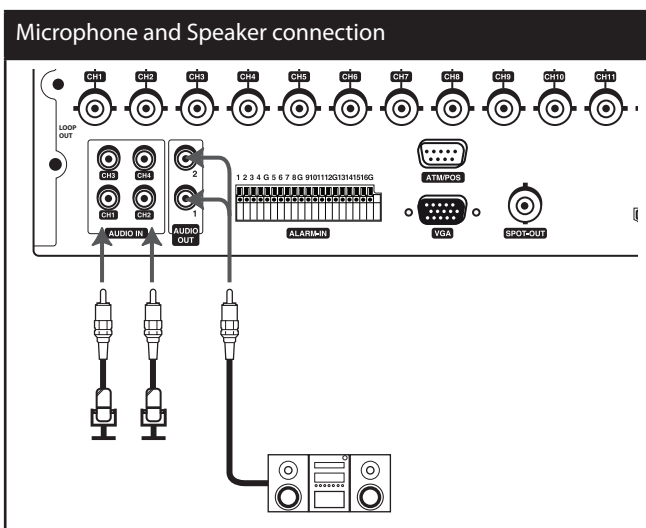

Connecting USB device

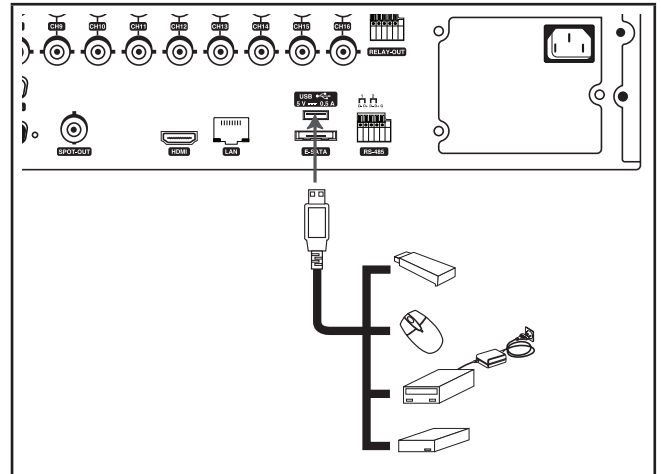
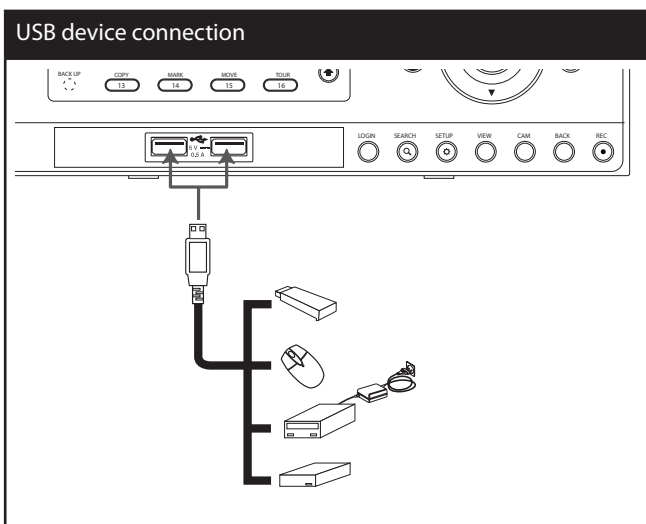

USB Memory device

Insert the memory device into the USB port. The system automatically recognizes the device. The system software can be easily upgraded using a USB memory device.

USB External device

Connect the external device to the USB port. (Example: External HDD or other external storage.)

Mouse

Connect the USB mouse to operate the functions of the DVR.

Connecting E-SATA device

You can use E-SATA storage for data back-up or recording.

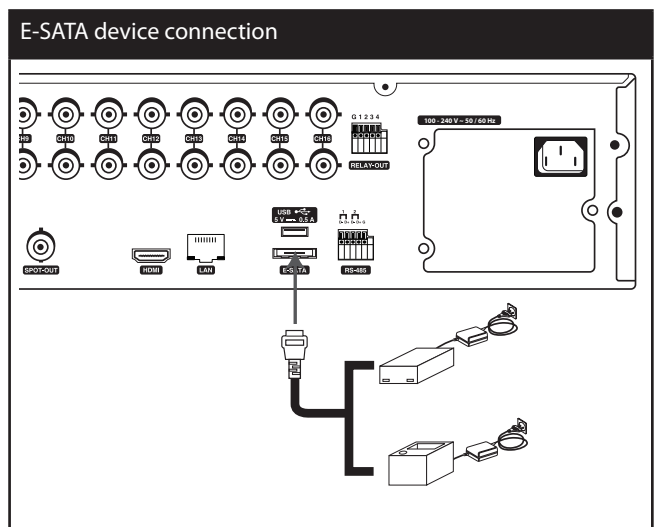

Connecting ATM/POS

Connect the ATM/POS unit to the ATM/POS port.

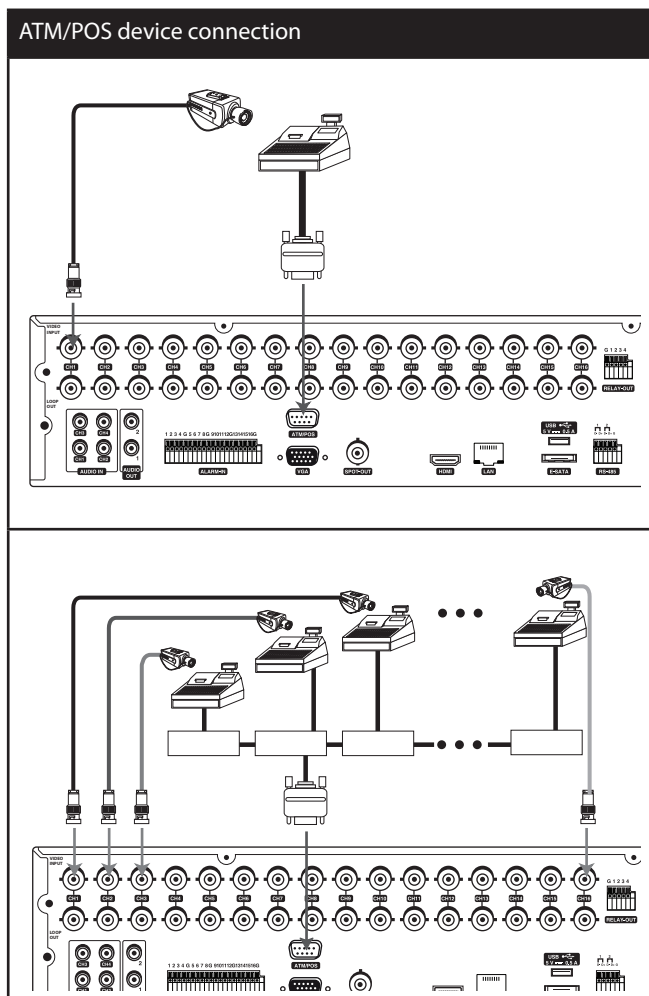

NOTE

- The following device has been tested and compatibility is ensured. When you use the multiple ATM/POS device, use the recommended device.
 - AVE Products
 - > VSI-PRO: Video serial interface
 - > Regcom: RS-485 networker
 - > Hydra: RS-485 to RS-232 converter
- The installation and connection work should be done by qualified service personnel or system installers and should be conformed to all local codes.

Connecting Network

You can control and monitor the system via network. With the remote control (monitoring), you can change the system configuration or monitor the image via network. After the installation, check the network settings for the remote control and monitoring work.

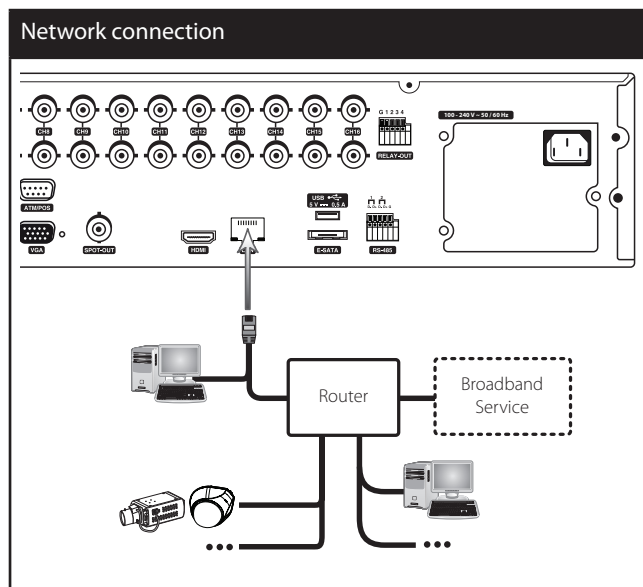

LAN connection

Connect the LAN port to an available 10/100/1000 base-T port with a straight ethernet cable (not supplied). The NET indicator on the front panel will be lit.

Automatic network configuration

The DVR can automatically obtain and configure the network interface via DHCP.

Manually configure network

The DVR may be manually configured by assigning an IP address, subnet mask, gateway and DNS.

NOTE

This unit can be supported IPv4 and IPv6 network.

Connecting RS-485 device

This DVR has two data terminals. Use this port to connect PTZ cameras, DVRs or keypads (optional).

RS-485 Terminal	Description
D - (DATA -)	Data Transmission/Reception
D + (DATA +)	Data Transmission/Reception
GND	Shield

Connecting the PTZ device

Connecting the PTZ serial communication lines to the RS-485 terminal.

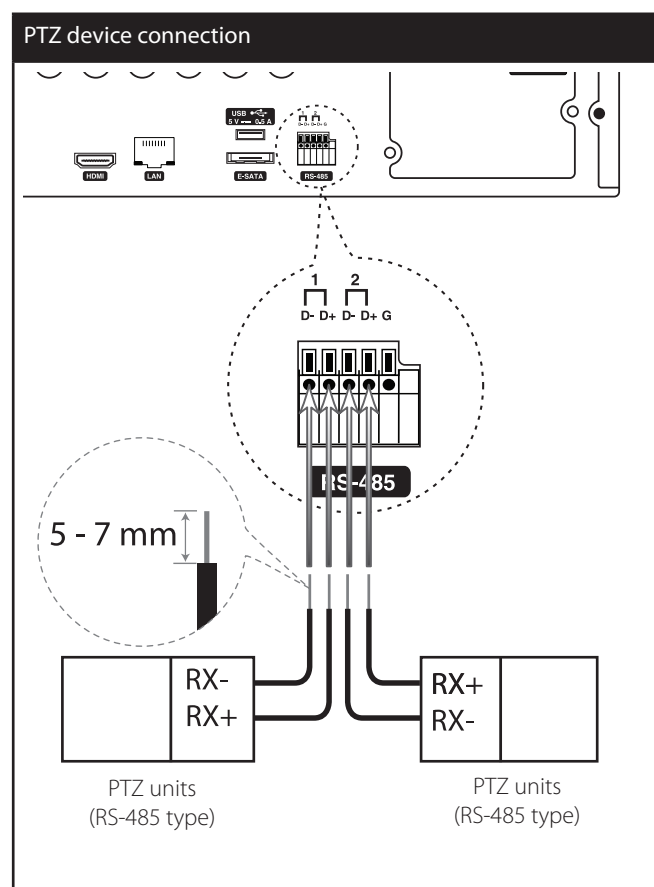

NOTE

- When connecting lines, connect the "D -" of the DVR to "RX -" of the PTZ unit and "D +" of the DVR to "RX +" of the PTZ unit correctly.
- Recommended initial data are 9600 Baud Rate, 8 Data bits, 1 Stop bit and No parity.
- When connecting PTZ cameras to DVRs it is necessary to set the setup menu for this unit according to the RS-485 settings of the camera and DVRs.

Connecting LKD1000 controller

Connect the LKD1000 controller to control the DVR. (Refer to the manuals of the LKD1000 controller for more details.) The LKD1000 controller has to be connected to the 2 (DATA 2) port as shown illustration. If you connect the LKD1000 controller to the 1 (DATA 1) port, the LKD1000 controller will not be activated.

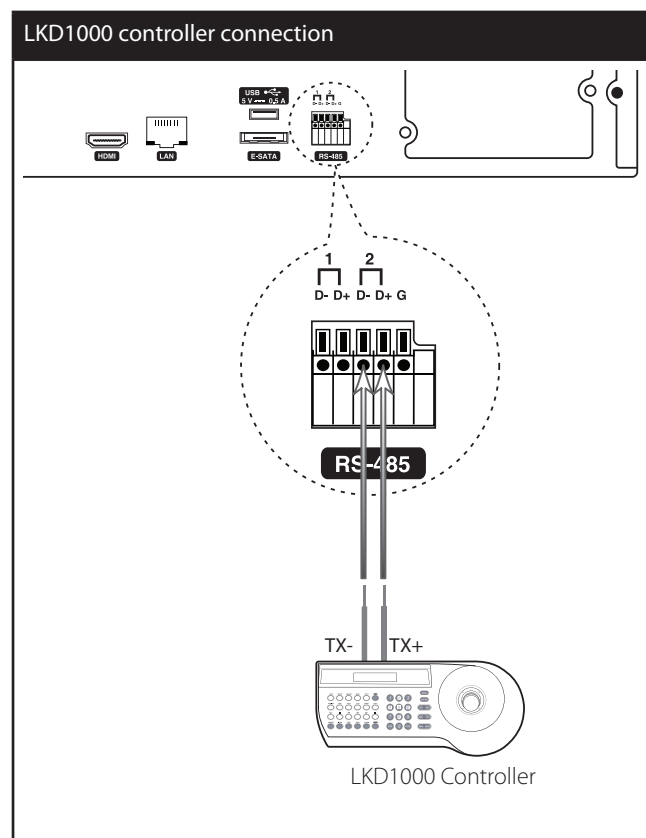

NOTE

Do not connect a PTZ camera and LKD1000 controller to the D1 or D2 port at the same time. It may cause a malfunction.

Connecting Alarm Input and Alarm Output

Alarm terminals are used to connect the alarm devices such as sensors, door switches, etc.

Alarm Input

You can connect up to 16 alarm sensors (LRD5080: 8 alarm sensors). Each alarm sensor should be connected with G (GND). The signal state is adjustable to N/O (Normal Open) or N/C (Normal Close) through the setup menu.

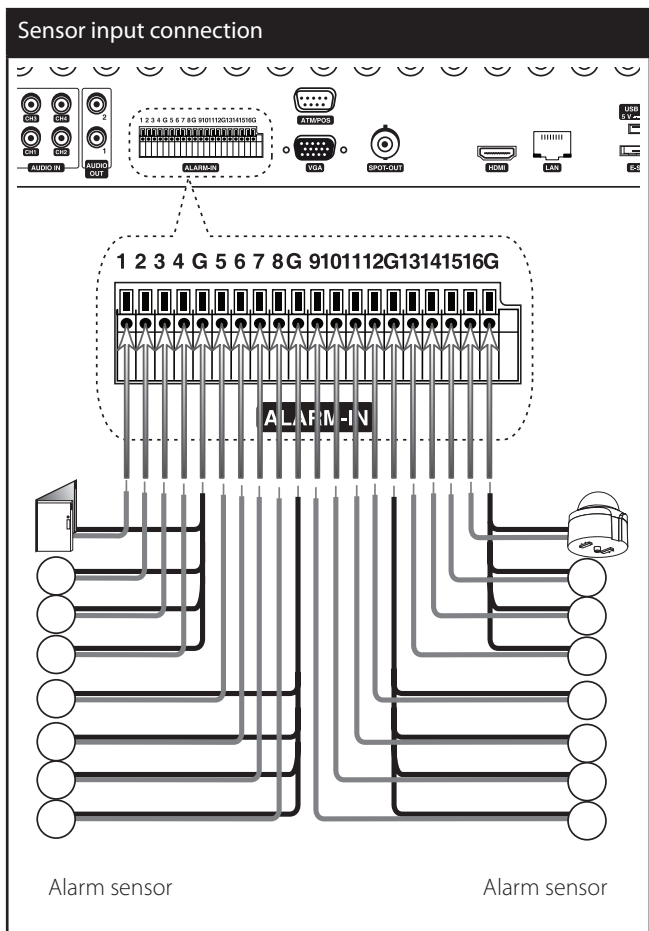

Terminal No.	Description
1	Sensor Input 1
2	Sensor Input 2
3	Sensor Input 3
4	Sensor Input 4
G	Ground
5	Sensor Input 5
6	Sensor Input 6
7	Sensor Input 7
8	Sensor Input 8
G	Ground
9	Sensor Input 9
10	Sensor Input 10
11	Sensor Input 11
12	Sensor Input 12
G	Ground
13	Sensor Input 13
14	Sensor Input 14
15	Sensor Input 15
16	Sensor Input 16
G	Ground

Alarm Output

Connect the alarm device to the alarm output. Alarm signal outputs when an event occur.

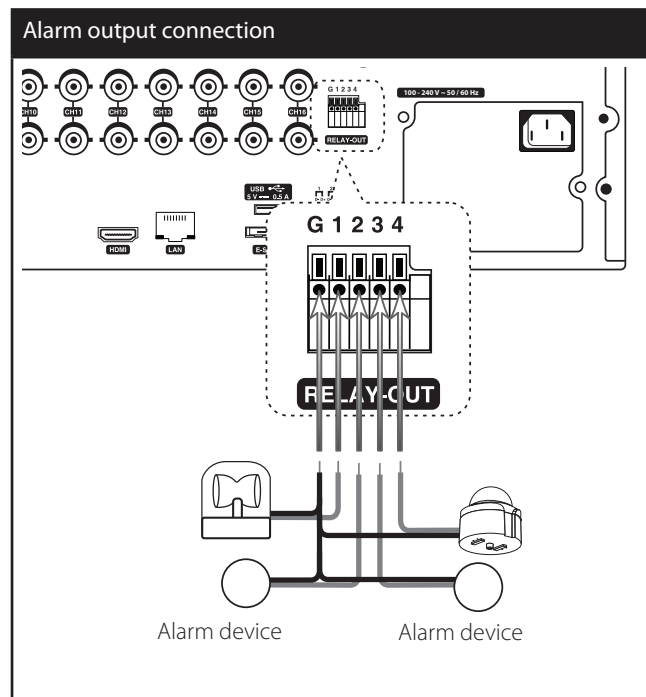

Terminal No.	Description
G	Ground
1	Alarm Output 1
2	Alarm Output 2
3	Alarm Output 3
4	Alarm Output 4

NOTE
 The internal switching relays are rated for 0.3 A at 125 V AC or 1 A at 30 V DC. If the electric current is higher than that the unit can be damaged.

HDD INSTALLATION

Note for Hard Disk Drive

The internal hard disk drive (HDD) is a fragile piece of equipment. Please follow the guidelines below when using the DVR to protect against possible HDD failure. We recommend that you back up your important recordings onto an external backup device in order to prevent accidental loss.

Make sure that the power is turned OFF when attaching or removing the HDD.

- Do not move the DVR while the power is on.
- Do not use the DVR in excessively hot or humid places, or in places that may be subject to sudden changes in temperature. Sudden changes in temperature can cause condensation to form inside the DVR. This can be a cause of HDD failure.
- While the DVR is switched on, do not unplug from the wall socket or switch the electricity off from the breaker switch.
- If there's a power failure while the DVR is on, some data on the HDD may be lost.
- Do not drop the HDD. Also do not put the metallic object such as coins or screwdrivers into the HDD tray.
- When a power failure occurs during recording, avoid adding, replacing or transporting the HDD as the recorded data may be erased. In this case, turn the power back on to boot up the unit normally with the HDD that was being used at the time of the power failure attached. Then add, replace, or transport the HDD.
- The HDD is very delicate. Handle the HDD with care and follow the precautions below because even a tiny shock may damage the internal components of the HDD.
 - Do not place the HDD on the desk or table directly. Put a thick cushion under the HDD because even a small shock may damage the internal components of the HDD.
 - Do not use an electric screwdriver. Vibrations and shocks caused by an electric screwdriver may damage the internal components of the HDD.
 - When replacing the HDD, do not knock the HDD with other components such as another HDD and the HDD tray.
 - Do not knock the HDD with tools such as a driver when replacing the HDD.
- Protect the hard disk drives from static electricity.

Installing the Hard Disk Drive

You can install up to 4 HDDs.

Improper installation or setup may disturb HDD recognition or normal product operation. So you should consult with an expert from the store where the product was purchased.

1. Detach the top case by sliding it after removing the screws.
2. Remove the screws and detach the hard disk mounting brackets from the unit.
3. Attach the HDD onto the hard disk mounting brackets with four screws.
4. Attach the hard disk mounting brackets with the screws.
5. Connect the HDD power cable to the HDD.
6. Connect the SATA cable to the HDD.

7. Connect the SATA cable to the SATA connector on the main board.
8. Assemble the top case.
9. Fix the screws.
10. When you turn the power of the unit on, the new HDD is detected and formatted automatically.

Replacing the Hard Disk Drive

Turn the power of the unit off and detach the power plug from the outlet.

1. Follow steps 1 to 2 described in "Installing the Hard Disk Drive".
2. Remove the connector from the HDD.
3. Remove the screws from the hard disk drive on the left/right side of the hard disk mounting bracket.
4. Remove the HDD from the hard disk mounting bracket.
5. Install the new HDD.
6. After replacing the hard disk drive, insert the power plug into the outlet and turn the power of the unit on. The new HDD is detected and formatted automatically.



NOTE

Do not use an electric screwdriver to fix them.

Recommended HDD

For the latest recommended HDD list, please visit <http://www.lgecommercial.com>



NOTE

If you do not use the recommended HDD, the system may not be operated normally.

System Operation

1. Turn on the unit. System booting will commence. The LG logo image will be displayed on the main monitor during the system booting.
2. When the booting is completed the live window will be displayed. Click the  icon on the system control bar or press the LOGIN button on the remote control to display the log-in window.
3. Select a user name by using the mouse or arrow and the OK button on the remote control or front panel. For the first time, you can select the ADMINISTRATOR user name only. You can register a new user with various access rights using the user setup menu.
4. Enter the password by using the virtual keyboard. (Note that the default administrator password is "000000".)
5. Click the [OK] icon.
You can see the live screen and operate the system.

NOTE

- This DVR is based on a VGA monitor using OSD. We recommend you to using the VGA monitor with this unit. If you use a composite monitor, the OSD quality may be low to read it.
- If the DVR is turned off accidentally and then turned on again, the DVR may take a long time to be rebooted.

System Shutdown

1. First, you must stop playback and exit the setup menu. In playback, press STOP.
2. Press and hold  (POWER) button until the beep sounds and the logout window will be displayed.
3. Enter the password by using the virtual keyboard.
4. Click the [OK] icon. The system will shutdown.

General Explanation of the Live Screen on the Main Monitor

Main Monitor Screen



1 Channel Number

Displays the channel number.

2 Channel Name

Displays the edited channel name.

3 Channel FPS





Displays the channel FPS value.

4 Selected Channel







Displays the selected channel with red box.

5 Quick Buttons

The Quick Buttons will appear when the mouse is moved to the camera's live screen. You can use the following functions by clicking it for the selected channel.

	You can use the playback function.
	You can use the digital zoom function.
	You can control the PTZ Camera. (optional)
	You can use the video adjustment (Brightness, Contrast, Color) function. (Analog Channel Only)

6 Camera Status Icon











	Displays the PTZ camera status.
	Displays the input audio status.
	Gold "C" indicates continuous recording.
	Gold "I" indicates Instant recording.
	Red "S" indicates sensor triggered recording.
	Green "M" indicates motion detection recording.
	Gray "N" indicates the channel is not being recorded.

T	Violet "T" indicates text event recording.
----------	--



7 Live Screen

Displays the current surveillance live screen.

8 System Control Bar

	Displays date and time.
	Login (Logout) : Display the User Log-In dialog box or logs out.
	Search: Displays the search menu.
	Alarm Off: Turns the alarm off.
	Camera: Displays the Monitor menu to set the first camera channel.
	Split mode: Displays the menu for selecting the screen division.
	Video Export: Displays the export menu.
	System Log: Displays the system log list window.
	System Information: Displays the system information window.
	Setup: Displays the setup menu.
	Minimizes the System Control Bar.

NOTE

- **To display / minimize the system control bar**
To display or minimize System Control Bar, press OSD after pressing the SHIFT button on the front panel or click  or  in the System Control Bar.
- You can also use the system control's options by clicking the right button of the mouse on the Main Monitor screen.
- While the main monitor is performing the sequence mode, the  mark is displayed on the system control bar.

Moving the Channel's Position

You can change the camera channel's position in a split screen of the Main Monitor.

1. Select a desired channel by clicking the left button of the mouse.
2. Drag and drop it to a desired location and the channel's position will be changed.

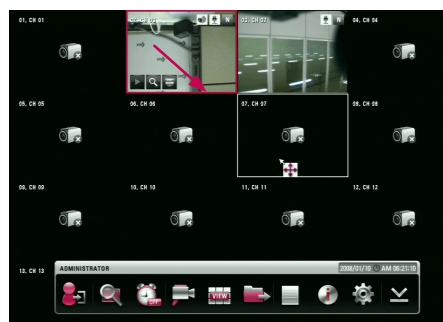

Selecting the Main Monitor screen mode

You can select the live screen mode to display a full, 4-split, 6-split, 8-split, 9-split, 16-split, 17-split or 25-split screens on the main monitor.

1. Press VIEW or click  icon in the system control bar.
2. Select [Main Monitor].
3. Select a screen mode.

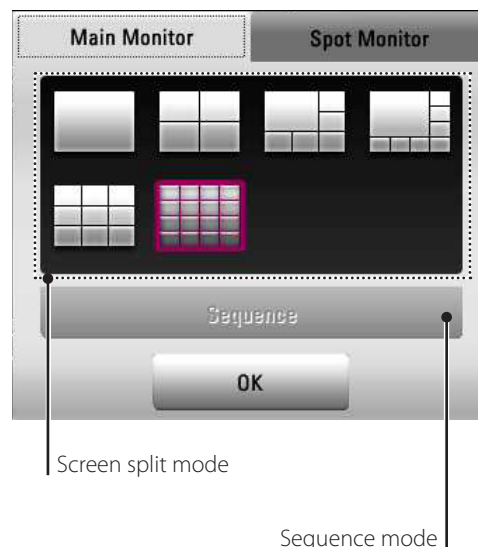

- **Full Screen Mode:** You can view the live window in full screen mode.
- **4, 9, 16, 1+5, 1+7 Split Mode:** Displays selected split screens on the main monitor.
- **Sequence:** You can view all the channels in sequence. You cannot use sequence mode with the 16 split (LRD5080 series: 1+7 and 9 split).

4. Select [OK] and press OK to confirm your selection.

NOTE

To display the screen you want to watch in full screen mode, double click the desired channel.

Selecting the Spot Monitor screen mode

You can select the live screen mode to full, 4-split, 9-split or 16-split screens on the spot monitor.

1. Press VIEW or click the  icon in the system control bar.
2. Select [Spot Monitor].
3. Select a screen mode.

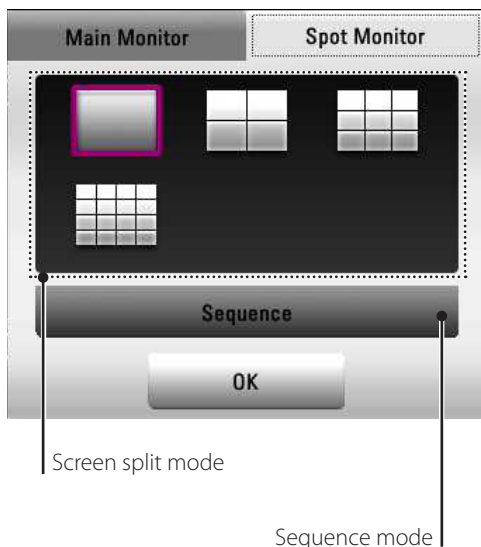

- Full Screen Mode: You can view the live window in full screen mode.
 - 4, 9 and 16 Split Mode: Displays selected split screens on the spot monitor.
 - Sequence: You can view all the channels in sequence. You cannot use sequence mode with the 16 split (LRD5080 series: 9 split).
3. Select [OK] and press OK to confirm your selection.

Grouping channels

You can group channels you want.

1. Press CAM or click the  icon in the system control bar.
2. Select [Main Monitor] or [Spot Monitor] on the menu.
3. Select a camera number for including group.
 - [Restore to Default] : Reset channels to ascending sort and change the [Split Mode] to 16 split (LRD5080 series: 1+7 and 9 split).

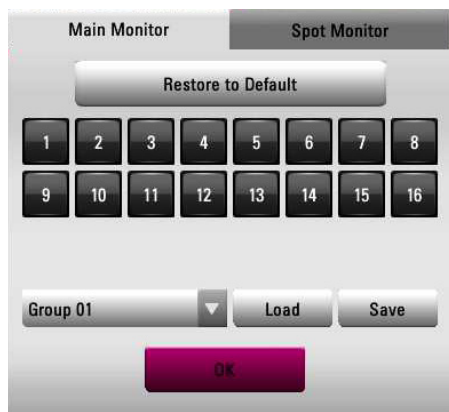

4. Select group number on the drop-down list.
5. Click [Load] or [Save] button to configure your group.
6. Select [OK] and press OK to confirm your selection.

















NOTE

The [Split Mode] changes according to a number of selected cameras.

PTZ Camera Control

You can control the cameras connected via the data port of RS-485 terminal or Network. You must set the configuration between the PTZ camera and the DVR.

1. Select the PTZ camera channel on the main monitor you want to control.
2. Press PTZ or click the  icon that appears when the mouse is moved to PTZ camera's screen. Virtual PTZ remote control is displayed on the main monitor.
3. Use each item to control the PTZ camera.

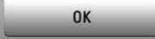
Button	Function
	Displays the PTZ control guide.
	Displays the setup menu of the PTZ camera.
	Minimizes PTZ virtual remote control.
	Removes the PTZ virtual remote control.
	Use to pan/tilt the camera.
	You can select the Pan/Tilt/Zoom speed.
	You can adjust the camera zoom.
	You can adjust the focus of a camera manually.
	You can adjust the iris of a camera manually.
	Displays or disappear the preset control options in the virtual PTZ remote control
	Displays the Selected Preset number.
	To input the preset number.
	To register preset positions.
	To delete a memorized preset position.
	To move the camera to the preset position.
	To start a preset tour.
	Confirm the preset position.

NOTE

You can use some options by clicking the right button of the mouse in PTZ camera control mode.

- PTZ Control Guide: Shows the guide for using the mouse.
- Exit: Exits from the PTZ camera control mode.

Preset Settings

Preset position is the function to register camera monitoring positions (preset positions) associated with position numbers. By entering the position numbers, you can move cameras to the preset positions.



NOTE

To activate this function, you need to register the preset positions of the PTZ cameras.

To Register Preset Positions

1. Move the camera to a point you wish by using the





2. Press SET or click the  icon.
3. Select the preset number you wish to register.
4. Press OK or click the  icon.
The position and its number are memorized.
5. Repeat steps 1 to 4 to add additional positions.

NOTE

Preset numbers from 0 to 255 are available on this unit but the actual preset range differs depending on PTZ cameras.



Changing to a Picture in a Preset Position

The following function is available only with cameras provided with the preset function. The preset function makes the combination camera move to the programmed preset position. It is necessary to program preset positions for the combination camera beforehand.

1. Press the MOVE button or click the  icon.
2. Use number buttons to enter the memorized preset position's index number then press OK or click the  icon.
The camera moves to the preset position and the picture of the camera in that position appears on the monitor.

To Clear the Preset Position

You can clear a memorized preset position.



1. Press the CLEAR button or Click the  icon.
2. Use number buttons to enter the memorized preset index number then press OK or Click the  icon to clear the preset positions.

NOTE

This function may not be available depending on PTZ cameras.











To Tour The Preset Positions

You can tour all preset positions.

1. Press the TOUR button or Click the  icon.
All registered preset positions in the camera will be selected and the camera position image will be switched on the active monitor.
2. You can stop the tour by pressing the TOUR button or clicking the  icon.

Setup for PTZ Cameras

You can adapt the camera to your requirements by setting up the respective items in menus.





1. Click the  icon.
The setup menu appears in the selected window of the main monitor.
2. Use         and  buttons to set the options.

NOTE

- Refer to the manuals of the PTZ camera for more details.
- Some PTZ cameras may not operated properly with this unit.
- You cannot control the other functions when the PTZ virtual remote control is displayed.

Using the Digital Zoom function

You can enlarge the current screen 2 times using the digital zoom function on one live channel with full screen mode or one channel playback with full screen mode.

1. Press ZOOM(+) button during viewing a live channel in full screen mode or playing back a channel in full screen mode.
2. You can use the zoom screen as following.
 - You can move the position of the zoom screen by using the     buttons.
 - You can move the zoom screen by using the mouse. Drag & drop a point to the specific point to move the zoom screen.
3. Press BACK button to exit.

NOTE

The zoom function is deactivated when below case.

- When double click the left mouse button.
- Press the specific channel or function button which front panel of the unit.
- Press the STOP button during the playback.

You can use some options by clicking the right button of the mouse in the digital zoom mode.

- Digital Zoom Control Guide: Shows the guide for using the mouse.
- Exit: Exits from the digital zoom mode.

Export the recorded data

This unit can manually copy recorded images and audio from built-in HDD to the external recording devices.

1. Press EXPORT or click the  icon in the system control bar. The [Video Export] menu appears.

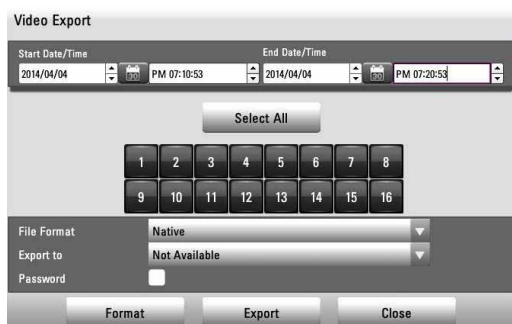

2. Set the [Start Date/Time] and [End Date/Time] to copy.
 - ◀/▶/▲/▼: Moves to the options.
 - ▲/▼: Sets the selected option.
 - OK: Selects option or confirms the setting.
3. Select the channel number and press OK. Repeat this step to select multi channels.
4. Select the one of file format on the drop-down list of the [File Format].
 - Native: The Native file is saved with the extension of "*.exp". The saved native file can playback using the Export Viewer program.
 - AVI LG: To playing AVI LG file, you have to install the LG DVR Codec. If you install the LG Network Client, do not need to install the LG DVR Codec.
 - AVI: If you select AVI file format, it can play on any media player.
5. Select [Export to] then press OK.
6. Use ▲/▼ to select a target device to export.
7. Press OK to confirm it.
8. You can set the password in case of the native file. To register the password, click the checkbox of [Password]. The password window is displayed. And then, enter the password by using alphabetic letter and numeric digit 4-12 characters.
9. Click the [Export] icon to start exporting. The exported data will be authorized by the unit before saving and it can only be played back with the exclusive player.

! NOTE

- Check the export device before you proceed.
- You can also use the EXPORT button on the front panel for export function.
- You can export the recorded data only in the live mode.
- If you use the external device, the external device has to be formatted on this unit.
 1. Connect the external device to the USB port on the front or the rear of the DVR.
 2. Select the [Format] icon then press OK. Confirm window is displayed after format is completed.
 3. Select [OK] and press OK to close the window.
- Check the size of the selected data and free space of the external device. If the device does not have enough space, create space on the device or erase the previously stored data.
- Export can not be executed while the backup is in progress.
- You can search the exported data with the supplied viewer software.
- When you export the recorded data, the video data, audio data, the system log and event log data will also be exported.
- When you export the recorded data the export viewer program will also be exported in the [ExportViewer] folder of the device. The exported data file name is made automatically as the [Channel name_export date_export time.exp] type.
- Do not remove the USB device while the export is in progress, it may cause a malfunction.
- The warning message appears for the conditions listed below.
 - When the start date/time and end date/time are the same value.
 - When the start date/time is later than the end date/time.
 - The export media does not have enough space.
 - When you set the time for data that does not exist.
- An external media has to be formatted on this unit to prevent a malfunction.

Viewing the System Log List

To view the system log list:

1. Press the LOG button or click the  icon in the system control bar. The system log list window is displayed on the main monitor.

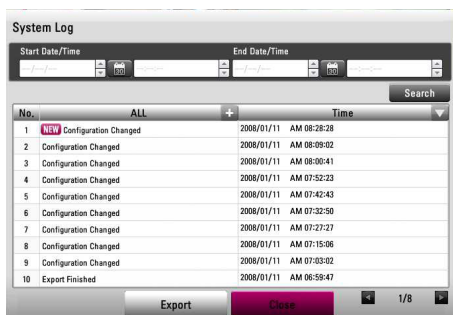

2. Set the [Start Date/Time] and [End Date/Time] to copy.
 - ◀/▶/▲/▼: Moves to the options.
 - ▲/▼: Sets the selected option.
 - OK: Selects option or confirms the setting.
3. Use ◀/▶ to see the previous or next log list.
4. Press the BACK button or click the [Close] button to exit the window.

NOTE

Refer to the following system log list.

No.	Log Message
1	Power On
2	Power Off
3	Login (Remote)
4	Logout (Remote)
5	Login (Local)
6	Logout (Local)
7	Configuration Changed
8	Configuration Imported
9	Factory Default Set
10	Power Recovery
11	Backup Started
12	Backup Finished
13	Backup Failed
14	Export Started
15	Export Finished
16	Export Failed
17	S/W Updated
18	HDD Damaged
19	HDD Added
20	HDD Deleted
21	HDD Formatted
22	HDD Changed
23	System Fan Failure

Viewing System Information

To view system information:

1. Press the INFO button or click the  icon in the system control bar. The system information window is displayed on the main monitor.



- Ethernet 0 : Displays the detail information of the Network.
- Camera Information: Displays the detail information of the camera framerate.

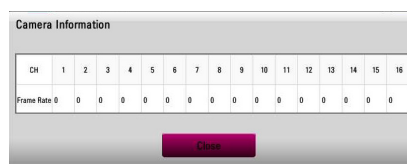

- HDD Information: Displays the detail information of the HDD.

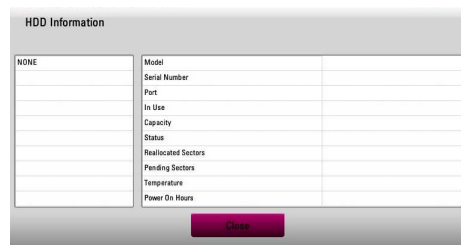

- Refresh: Updates the system information.
2. Press the BACK button or click the [Close] button to exit the window.



Configuration menu

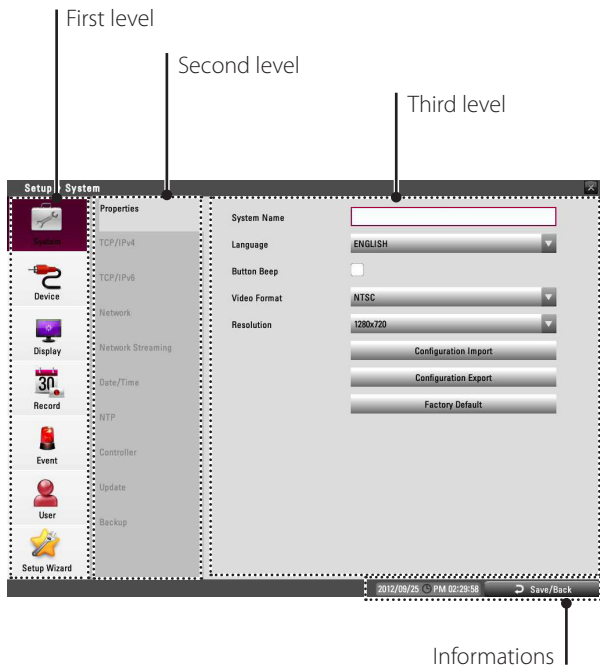

The features and options of the DVR are configured through the menu. The operations of this unit can be set via a menu displayed on the main monitor. You can select and set the operational conditions by using the buttons on the front panel and the remote control or using a Mouse connected to the unit.









Using a mouse to set a menu

Use the left or right mouse buttons to set the menu.

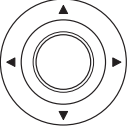
Button	Function
 Left button	<ul style="list-style-type: none"> Use to select a required item or decrease the options value. If you double click the button, you can see the selected channel on the full screen.
 Right button	Use to increase the options value.

- Click the  icon on the System control bar with the left mouse button to display a setup menu.
- Click the desired option with the left mouse button to display the second or third level menu options.
- Click the desired option with the left mouse button.
- Set the selected options value.
- Click the  icon or click  icon repeatedly to exit setup menu.
If the save message appears, click [OK] with the left mouse button to save the settings.

Setting the Menu Using the Front Panel Buttons or Remote Control Buttons

Front Panel	Remote Control	Description
		Use these buttons to select the menu options or adjust the options value.
		Select the option or confirm the setting.
		Return to the previous menu or level.

- Press SETUP to display the setup menu.
- Use ▲/▼ to select the desired menu item, then press OK to display the submenu.
- Use ▲/▼ to select the desired submenu item, then press OK to display the setting options.
- Use ▲/▼ to select the desired option then press OK to set the value.
- Use ◀/▶ to select the desired setting then press OK to confirm your selection.
- Press BACK repeatedly to exit the Setup menu.
If the save message appears, select [OK] and press OK to save the settings.

NOTE

- When you operate the function menu by using the remote control and front panel buttons, both buttons are operated in the same way to control the function menu.
- To use other functions of number buttons on the front panel, follow the below steps.
 - Press SHIFT. The button indicator turns red.
 - Select the function button you want.
- All the operation explanations are based on using the remote control.

System settings

Properties

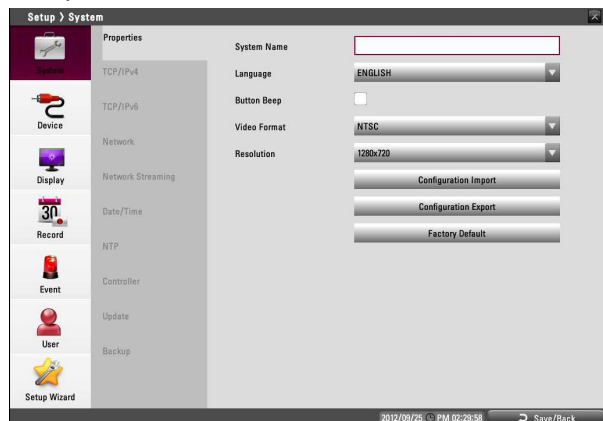

- System Name: Enter the system name by using alphabetic letter, numeric digit and symbols up to 21 characters.
- Language: Select a language for the setup menu and information display.
- Button Beep: Marks up to activate the button beep. The button beep is activated when using the buttons.
- Video Format: Selects the video format to NTSC or PAL according to your video system format. If you change the video format, the HDD is formatted with selected video format. After the HDD has been formatted, the confirmation message is displayed. Select [OK] and press OK. The system will reboot.



NOTE

All cameras must be disconnected before you change the video format to prevent malfunction.

- Resolution: Sets the output resolution of the HDMI video signal.
- Configuration Import: Import the DVRs configuration data from the USB memory stick.
- Configuration Export: Export the configuration data from this DVR to the USB memory stick.
- Factory Default: You can reset the DVR to its original factory settings. Some options cannot be reset (date, time, daylight saving, time zone and user password settings).

TCP/IP v4

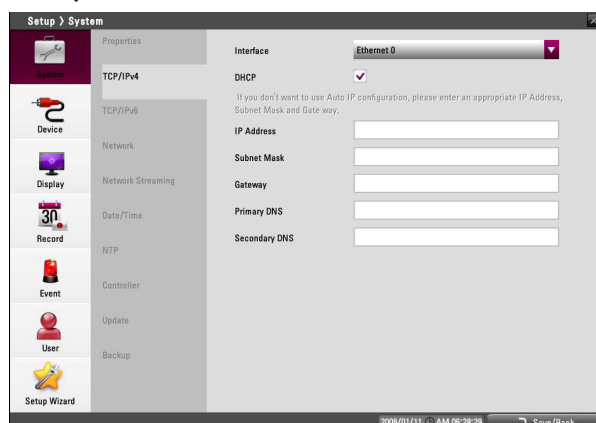

- Interface: Select a LAN port you want to use (Ethernet 0).
- DHCP: Select this option when a DHCP server is installed on the network to allow IP address assignment. With this setting, the IP address is assigned automatically.
- IP Address: Enter the IP address.
- Subnet Mask: Enter the subnet mask address.
- Gateway: Enter the gateway address.
- Primary DNS: Enter the Primary domain name server that translates the hostnames into IP address.
- Secondary DNS : Enter the Secondary DNS server address that backups the Primary DNS.

TCP/IP v6

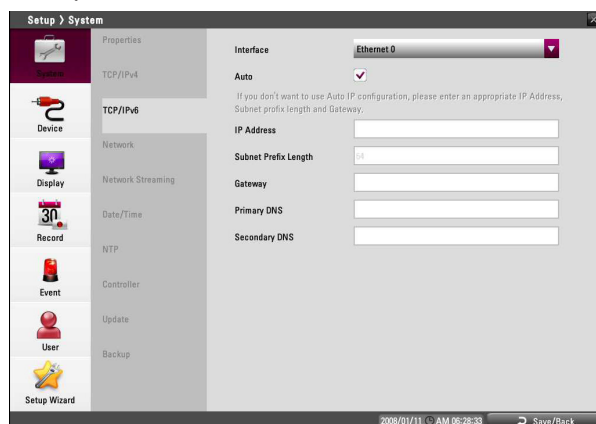

- Interface: Select a LAN port you want to use (Ethernet 0).
- Auto: Select this option to assign the IP address automatically.
- IP Address: Enter the IP address.
- Subnet Prefix Length: Enter the Subnet Prefix length. An IPV6 prefix indicates the portion of the address used for routing or identifying an address range.
- Gateway: Enter the gateway address.
- Primary DNS: Enter the Primary domain name server that translates the hostnames into IP address.
- Secondary DNS : Enter the Secondary DNS server address that backups the Primary DNS.

Network

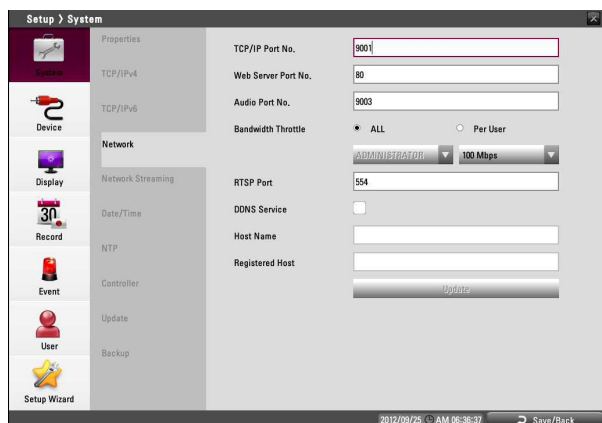

- TCP/IP Port No.: Enter the TCP/IP Port number. You can watch the live surveillance image over the network with the PC Client program. The factory default port for transmission of video and audio data is 9001. However in some cases it is better to change this port number for added flexibility or security. You can edit this port between 1025 and 65535.
- Web Server Port No.: Enter the Web Server Port number. You can watch the live surveillance image over the network with a web browser. Typically the TCP port used by HTTP is 80. However in some cases it is better to change this port number for added flexibility or security. You can edit this port to 80 or between 1025 and 65535.
- Audio Port No.: Enter the Audio Port number. You can edit this port between 1025 and 65535.
- Bandwidth Throttle: Select [All] or [Per User] to set the bandwidth value.
 - All: Set same bandwidth to all of users.
 - Per User: You can set the bandwidth value per each user. Select [User ID] from the left drop-down list. And then, set the bandwidth from right drop-down list
- RTSP Port : Enter the RTSP Port number. You can edit this port between 1 and 65535. Default Port number is 554.
- DDNS Service: Marks up to activate the DDNS function. This free service is very useful when combined with the LG DDNS Server. It allows the user to connect the IP device using the URL, rather than an IP Address. This also solves the problem of having a dynamic IP address.
- Host Name: Enter the host name you want to use. You can not use the "www", "mail", "http", "ftp", "com", "lg", "lge", "lgddns", "lgeddns", "ddns" for host name.
- Registered Host: The registered host name appears.
- Update: Register the host name you typed in [Host Name] to LG DDNS server.

How to register DDNS host name

With the DDNS function, you can easily use LG DVR.

When you use the DDNS function for the first time after you purchased LG DVR

1. Displays the DVR setup menu.
2. Select [System] > [Network] option.
3. Marks up for the [DDNS Service] option.
4. Enter the host name in the [Host Name] option.
5. Press the [Update] button. If host registration is properly completed, the host name will be displayed in the [Registered Host] option. If the host name is not registered after updating,

please check network connection.

When you want to change DDNS host name

If you want to change the registered host name to new one, follow as shown below.

1. Enter a new host name in the [Host Name] option.
2. Press the [Update] button. The confirmation window will be displayed to change your host name.
3. Click the [OK] button. When host name is properly changed, the changed host name will be displayed in the [Registered Host] option. If host name is not changed after updating, please check network connection.

Network Streaming

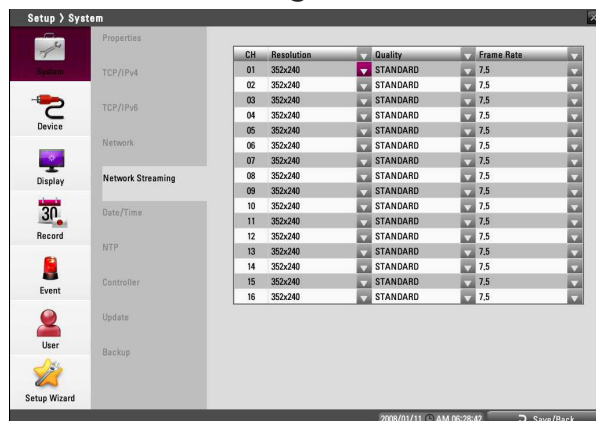

- CH: Displays the channel number.
- Resolution : Selects the recording resolution.
- Quality: Selects the recording picture quality.
- Frame Rate: Selects the frame rate. The frame rate is the number of transportable frames per second. According to resolution, the frame rate is set automatically. If you wish to set manually, refer to the below.

	Resolution	Frame Rate
NTSC	352*240	1, 3, 5, 7.5, 10, 15, 30
	704*240	1, 3, 5, 7.5, 10, 15
	704*480	1, 3, 5, 7.5
PAL	352*288	1, 3, 5, 6, 7.5, 12.5, 25
	704*288	1, 3, 5, 6, 7.5, 12.5
	704*576	1, 3, 5, 6

Date/Time

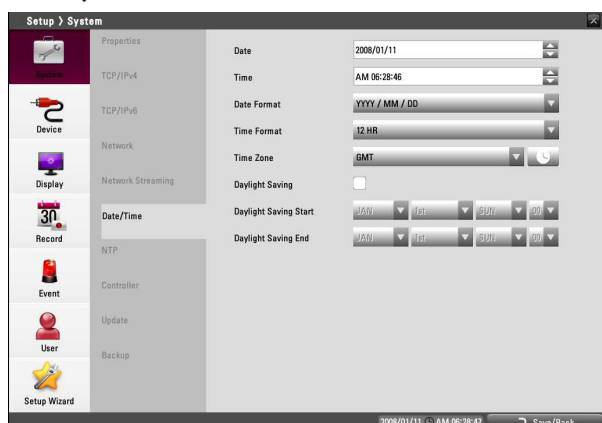

- Date: Select the current year, month and day.
- Time: Select the current time.
- Date Format: Select the date display format.
- Time Format: Select the time display format.
- Time Zone: Select the time zone in the area where the DVR is installed.
- Daylight Saving: Mark up if you want to use the daylight saving function.
- Daylight Saving Start: Select the Daylight Saving start time.
- Daylight Saving End: Select the Daylight Saving end time.

NTP

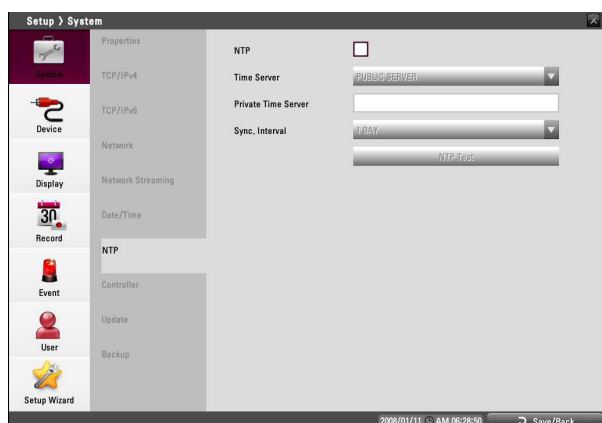

- NTP: Marks up, if you want to synchronize the DVR's date and time with those of the time server called NTP. (Network Time Protocol) Specify the NTP server's name.
- Time Server: For most cases select public. The DVR will obtain the average time among 5 public servers (time.nist.gov, time-a.nist.gov, time-b.nist.gov, ntp.nasa.gov, clock.isc.org).
- Private Time Server: Enter the private time server's IP address or host name using the virtual keyboard.
- Sync. Interval: You can set synchronized intervals with the NTP time server to 1 day, 1 week, 1 month and 1 hour.
- NTP Test: Select [NTP Test] to test the NTP server.

NOTE

If the NTP option is not set to this system, there can be a gap between the system time and actual time. Using NTP is recommended.

Controller

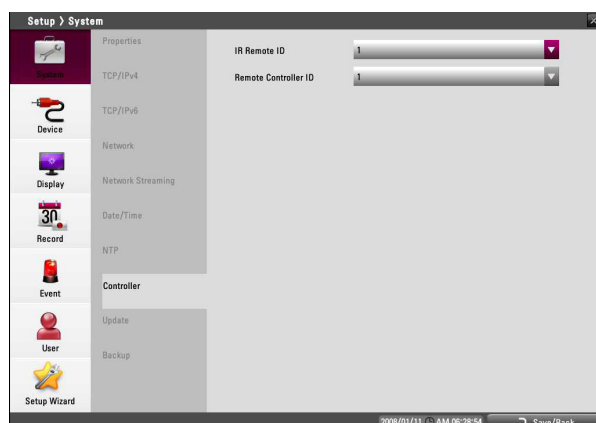

- IR Remote ID: Select the IR Remote ID for this unit. If you use multi systems set the IR Remote ID for each DVR unit.
- Remote Controller ID: Select the Remote Controller ID for this unit. If you use multi systems, set the Remote Controller ID for each DVR unit. You can control the DVR by using the LKD1000 controller. (For more details refer to the LKD1000 owner's manual.)

Update

The update feature allows you to upgrade DVR software and add/upgrade PTZ protocols. In this case, the current DVR settings are not deleted or replaced during the update process.

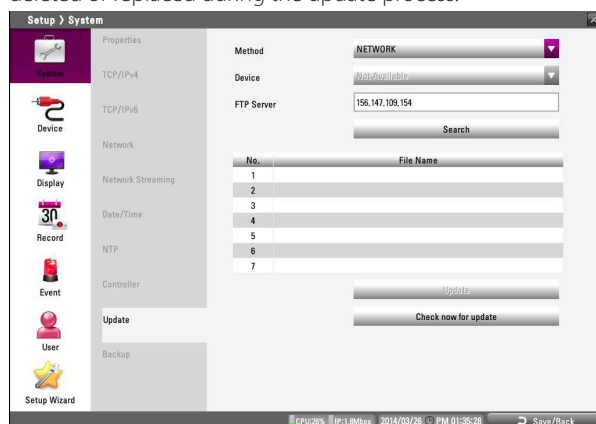

1. Selects the update method.
2. Selects the device included update file or enter the FTP server name.

NOTE

If you select the update method to [LOCAL], the [FTP Server] option will be disabled and the [Device] option is activated. And if you select update method to [NETWORK], the [Device] option will be disabled and [FTP Server] option is activated.

3. Select the [Search] button and press OK. The update file is displayed in the list.
4. Choose the update file from the list.
5. Select the [Update] button and press OK. The confirmation window is displayed.
6. Select [OK] to begin the update process or click [Cancel] to stop and exit. After the update process is completed, the [Restart the system] message appears.

7. Click [OK] to restart the DVR.
8. To confirm the latest version, click the [Check now for update] button to visit <http://www.lgecommercial.com>

NOTE

- Do not turn the power off during the update process to prevent the malfunction.
- Do not remove the external device for update while the update is in progress. It may cause a malfunction.

Backup

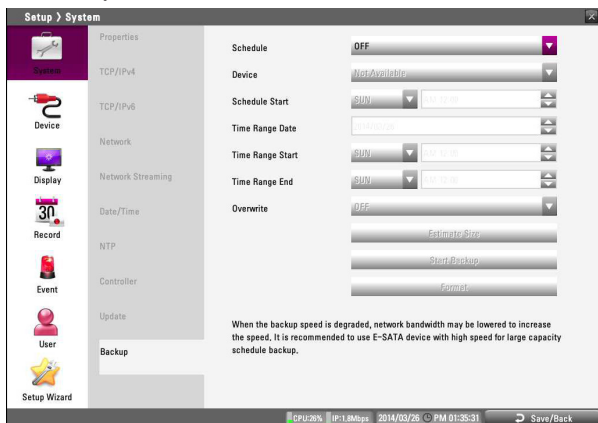

- Schedule: You can set the backup schedule.
 - OFF: All options are disabled.
 - WEEKLY or DAILY: The backup data will be automatically saved according to the setting.
 - INSTANT: The backup data is saved manually.
- Device: Select a backup device.
- Schedule Start: Set the schedule start date (A day of the week and time).
- Time Range Date: Enter the backup time range. Enter the date you want to backup.
- Time Range Start: Enter the start day of the week or time.
- Time Range End: Enter the end day of the week or time.
- Overwrite: Sets whether you use Overwriting function for schedule backup.
- Estimate Size: Displays the size of backup data and the free space of external devices.
- Start Backup: To start backup.
- Erase Media: To erase the media.

Instant Backup

1. Connect the backup USB device or insert a recordable disk to the disc driver for backup.
2. Select the partition you want to backup.
3. Select INSTANT from the schedule options.
4. Select the backup device.
5. Select the Time Range Date, Time Range Start time, and Time Range End time for backup.
6. Select the [Estimate Size] icon and press OK.
7. Check the size of the selected data and free space. If the device does not have enough space, create space on the device or erase the previously stored data.

8. Select the [Start Backup] icon and press OK to start backup.
9. Exit the setup menu. You can check the backup status on the system control bar in backup progress.

Daily/Weekly backup

1. Connect the USB device for backup.
2. Select WEEKLY or DAILY on the schedule options.
3. Select the backup device.
4. Enter the date and/or time to start backup on the schedule start option.
5. Enter the day of week and/or time on the Time Range Start option.
6. Enter the day of week and/or time on the Time Range End option.
7. Select On or Off in the [Overwrite] option.
8. Select the [Estimation Size] icon and press OK.
9. Check the size of selected data and free space of USB device. If the USB device does not have enough space, change the USB device to a USB which has enough space or erase data of the connected USB device.

NOTE

- The backup function is not supported on the external USB CD-ROM driver.
- Available external device for backup.

Device	Capacity
USB HDD	Up to 2 TB.
E-SATA HDD	Up to 2 TB.

- Use the recommended external USB devices for preventing malfunction (See page 53).
- For the latest recommended HDD list, please visit <http://www.lgecommercial.com>
- An external media has to be formatted on this unit to prevent malfunction.
- You cannot use the [Estimate size], [Start Backup] and [Erase Media] options in backup progressing.
- Do not remove the external device while the backup is in progress, it may cause a malfunction.
- If you format the external media by using a PC with FAT32, the media may not be used on this unit.
- Check the size of the selected data and free space of the external device. If the device does not have enough space, create space on the device or erase the previously stored data.
 1. Select the [Estimate Size] icon and press OK.
The size of the selected data and free space is displayed.
 2. Select [OK] and press OK to close the window.

NOTE

- You cannot stop the backup when the backup is in progress.
- The warning message will appear for the conditions listed below.
 - When the start time and end time are the same value.
 - When the start time is later than the end time.
 - When you set the time for data that does not exist.
 - When the start time and end time setting are wrong.
 - A media does not have enough space.
 - When the selected USB device is disconnected.
- The disc burning is carried out by a multi session mode.
- You can see the backup progress status on the system control bar.
- The estimated size of backup data is only the approximate size. So you must prepare sufficient space on the media to prevent lack of space.
- At the scheduled recording time, you can check the backup status on the system control bar.
- While export is in progress or searching the backup data from the external USB device, the scheduled backup will not be started. After the export or backup search is finished, scheduled backup will be restarted.
- When you set the schedule backup, the backup data size is estimated from the recording settings of the Setup menu. If the real recorded data size is over the estimated recording data size, the schedule backup may not be activated.
- If you use the overwrite function in the [Backup] option, the oldest backup data is deleted.
- Although all of backup data is deleted, backup is not implemented if the device does not have enough space.

Device settings

Camera

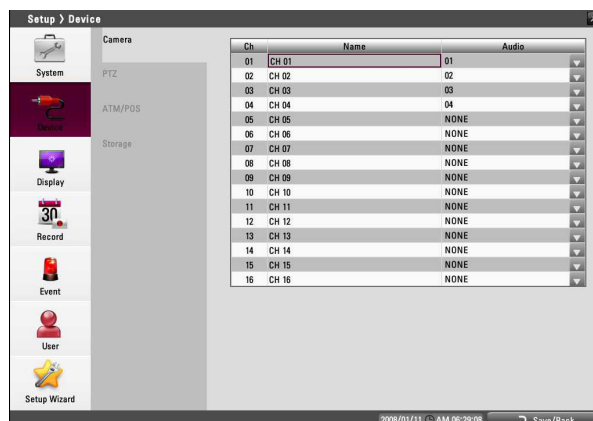

- Ch: Displays the channel number.
- Name : Set the channel name by using alphabetic letter, numeric digit and symbols up to 21 characters.
- Audio: Select the input audio channel. You can hear from the selected input audio channel.

PTZ

Settings for the PTZ cameras connected via the data port of the RS-485 terminal.

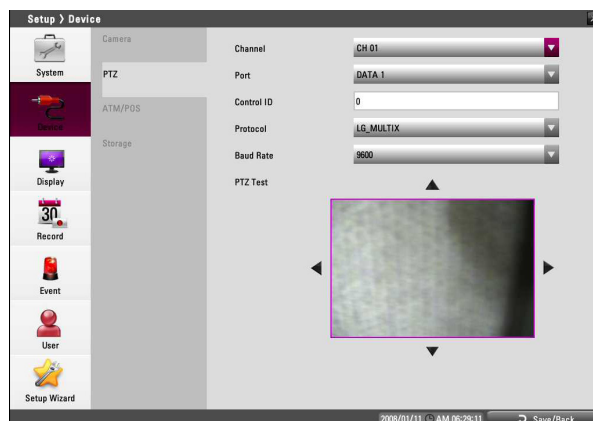

- Channel: Selects the desired channel to set the connected PTZ camera.
- Port: Selects the connected data port of the RS-485 terminal on the rear panel. The DATA 2 port is used to control the PTZ camera connected to DVR or to control by using the LKD1000 controller. If you want to use the PTZ camera via DATA 2 port, you should set the [Remote Controller ID] to [NONE]. If you use the LKD1000 controller to control the DVR via DATA 2 port, you should set the [Remote Controller ID] number between 1 and 16.
- Control ID: Selects the PTZ camera ID. Make the same settings as the PTZ camera.
- Protocol: Selects the protocol supported by PTZ camera.
- Baud Rate: Selects the communication speed.
- PTZ Test: After the PTZ setting, you can test the pan/tilt function for the selected PTZ camera. You can see the test screen from the preview windows on the right side of the PTZ test option.
 - ◀/▶: Tests the pan direction.

- ▲/▼: Tests the tilt direction.



NOTE

The supported PTZ camera list is on page 54 for reference.

ATM/POS



- Interface Device: Select the interface device from the drop-down list.
 - NONE: Selects when the ATM/POS device is connected with the DVR directly.
 - AVE Hydra: Selects when the ATM/POS device is connected via the AVE Hydra device to the DVR. If you set to AVE Hydra, the [Camera], [Baud Rate], [Data Bits], [Stop Bits] and [Parity] options are dimmed and these options cannot be set.
- Camera: Select the camera number for mapping with ATM/POS device.
- Baud Rate: Select the desired parameter to set the communication speed between DVR and ATM/POS device.
- Data Bits: Select the number of the data bits for RS-485 communication.
- Stop Bits: Select the desired parameter. The stop bit is added to the last of data, in asynchronous communication.
- Parity: Select the desired parameter. The parity bit is added to the data, to perform parity check.

date, the recorded data will be deleted except the data within the selected date period of time. The Auto Delete function is activated every 35 minutes.

- Storage Saving : Saves the storage space by reducing the quality of the recorded data.
- Format: Initializes the HDD (Hard Disk Drive). All data on the HDD will be erased.
- E-SATA : Selects the E-SATA device.
- Insert: Uses the selected E-SATA storage for recording data.
- Eject: Uses the selected E-SATA storage for data back-up.

Storage

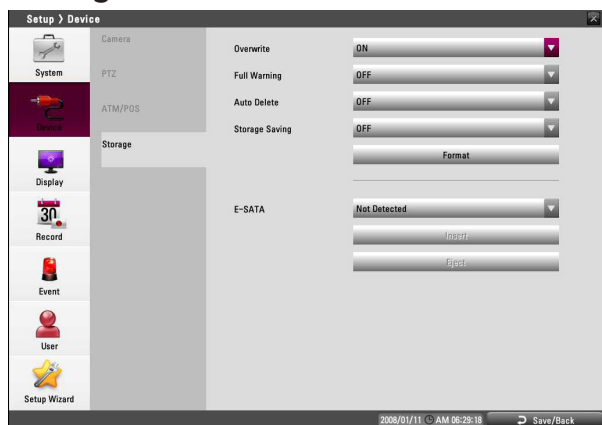

- Overwrite: : Sets whether you use Overwriting function.
- Full Warning: When the HDD has overflowed a warning message is displayed.
- Auto Delete: Sets the auto delete date. If you set the auto delete

Display settings

OSD

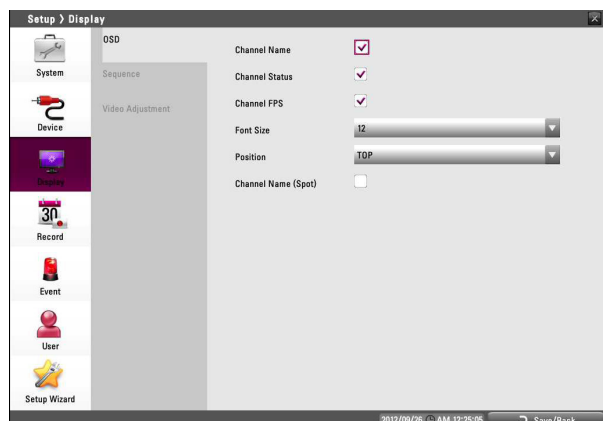

- Channel Name: Mark up to display or remove the channel name in the channel window.
- Channel Status: Mark up to display or remove the channel status in the channel window.
- Channel FPS: Mark up to displays or removes the channel FPS (Frame Per Seconds) in the channel window.
- Font Size: Selects the font size of characters such as the channel name and playback time which displayed on the channel window.
- Position: Selects the position of characters such as the channel name and playback time which displayed on the channel window.
- Channel Name (Spot): Mark up to display or remove the channel name on the spot monitor.

Video Adjustment

Adjust the brightness, contrast and color settings of each camera channel. You can see the settings screen from the preview windows.

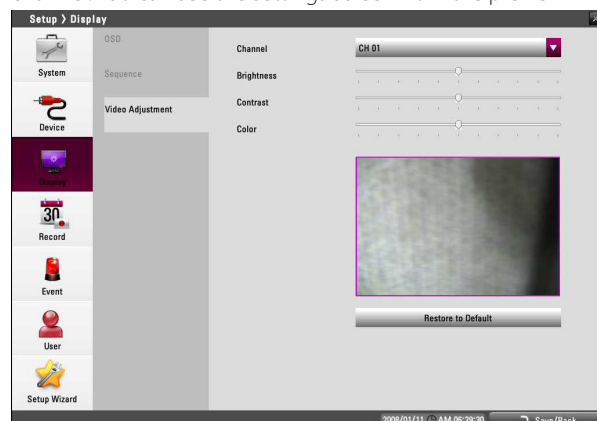

- Channel: Selects the desired channel to adjust.
- Brightness: Adjust the brightness value from 0 to 100 for the selected channel.
- Contrast: Adjust the contrast value from 0 to 100 for the selected channel.
- Color: Adjust the color value from 0 to 100 for the selected channel.
- Restore to Default: Sets to default setting value.

Sequence

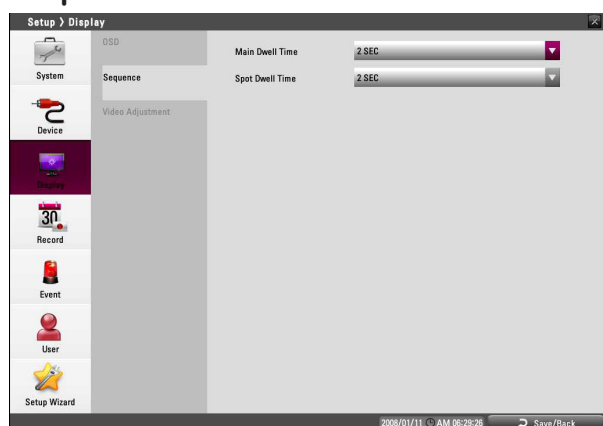

You can view all the channels in sequence in the selected screen division mode. You cannot use sequence mode with the 16 split (LRD5080 series: 8 split). While the sequence mode condition, if you change the screen division mode, the sequence function will be canceled.

- Main Dwell Time: Selects the channel sequence time for main monitor.
- Spot Dwell Time: Selects the channel sequence time for spot monitor.

Record settings

Normal Schedule Recording

A Normal schedule recording can be activated at preset times, in a repeating pattern on selected weekdays. The DVR can record according to a schedule set by the user. It can also record manually regardless of date and time. The recording can be made either continuously or triggered by events (Sensor and motion detection).

The recording schedule screen displays one day of the week showing the schedule of all channels over a 24-hour period. For each 1-hour cell block the recording method can be specified. The recording method for each block is shown in color for easy viewing.

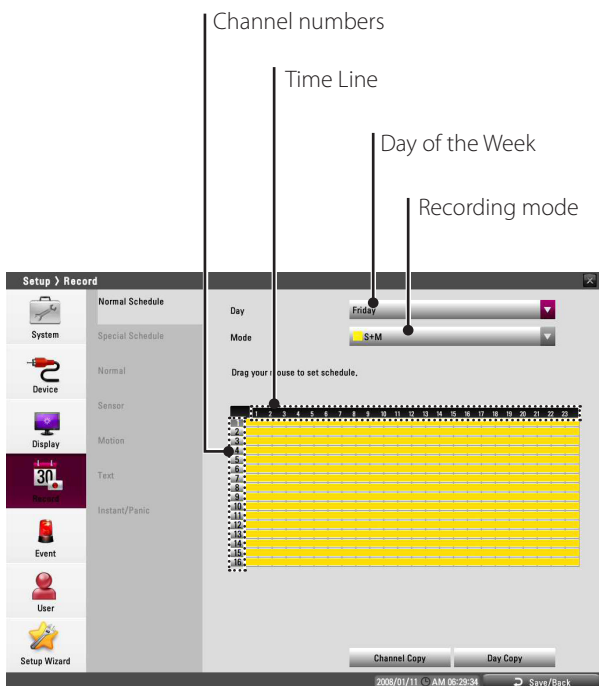

To Set a Recording Schedule for a Typical Day of the Week (Normal Schedule)

1. Select a day of the week.

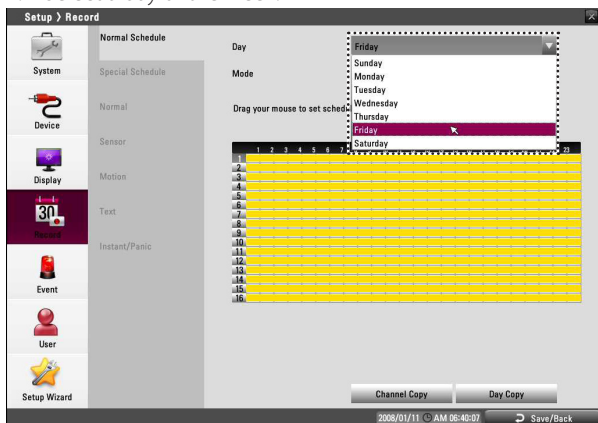

2. Select a recording mode.

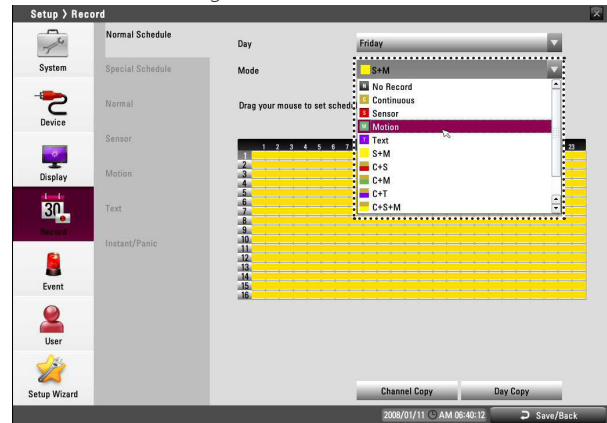

- Gray (No recording): No schedule recording.
- Gold (Continuous recording): Recording starts automatically from the preset time.
- Red (Sensor event recording): Recording starts automatically when the sensor occurs within a designated time.
- Green (Motion event recording): Recording starts automatically when motion is detected within a designated time.
- Violet (Text event recording): Recording starts automatically when text input is detected within a designated time.
- Yellow (Sensor+Motion recording): Recording starts automatically when the sensor signal has input or motion has been detected.
- Gold+Red (Continuous+Sensor event recording): Recording starts automatically from the preset time. When the sensor occurs within a designated time, changes the continuous recording mode to sensor event recording mode and recording starts automatically.
- Gold+Green (Continuous+Motion event recording): Recording starts automatically from the preset time. When the motion is detected within a designated time, changes the continuous recording mode to motion event recording mode and recording starts automatically.
- Gold+Violet (Continuous+Text event recording): Recording starts automatically from the preset time. When the text input occurs within a designated time, changes the continuous recording mode to text event recording mode and recording starts automatically.
- Gold+Yellow (Continuous+Sensor+Motion event recording): Recording starts automatically from the preset time. When the sensor signal has been input or motion has been detected, changes the continuous recording mode to motion event recording mode and recording starts automatically.
- Yellow+Violet (Sensor+Motion+Text event recording): When the sensor signal has been input, motion has been detected or the text input occurs and then recording starts automatically.
- Sky blue (Continuous+Sensor+Motion+Text event recording): Recording starts automatically from the preset time. When the sensor signal has been input, motion has been detected or the text input occurs within a designated time, changes the continuous recording mode to occurred event recording mode and recording starts automatically.

3. Drag and drop with left button of the mouse to set the channel and time you want to record. The color of the time block is changed depending on the selected mode.

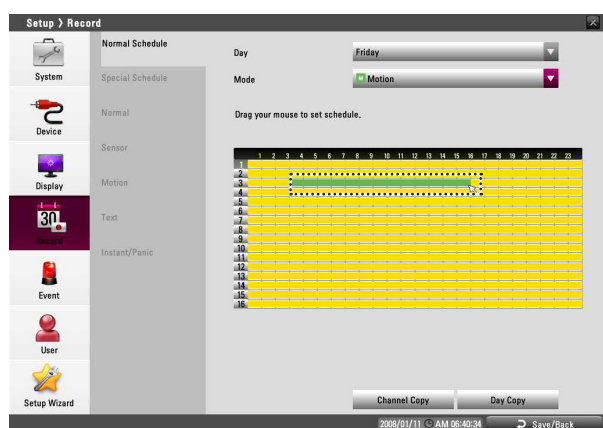
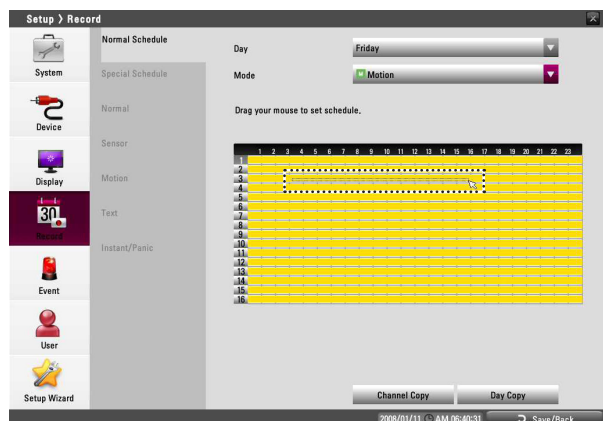

4. Press BACK to move to the previous menu. If the save message appears, select [OK] and press OK to save the settings.
5. Press BACK repeatedly to exit the Setup menu.

To Set a Recording Schedule for a Special Day (Special Schedule)

In addition to the weekly schedule, up to 15 specific date/time periods can be defined. To configure the specific recording schedule select Specific Dates.

1. Select an Item number.

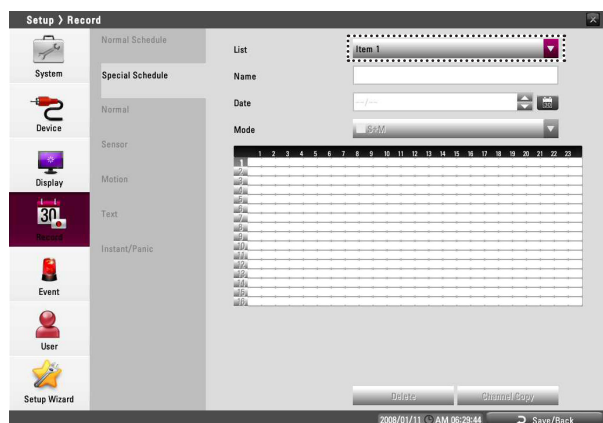

2. Enter the name of the special day. Use ▲/▼/◀/▶ to select the [Name] column and press OK. The virtual keyboard menu appears.

3. Use ▲/▼/◀/▶ to enter the necessary information for year, month and date. You can use the calendar icon to select the date.
4. Select the time cell block on the desired channel.

NOTE
If the special day recording schedule is duplicated with the other recordings, only the special day recording is possible.

Copying the Recording Schedule

Copying from the Scheduled Data of the Channel

You can copy the schedule data of the channel to the other channel(s) within the selected day of the week.

1. Select the day of the week and press OK on the [Normal Schedule] or [Special Schedule] menu.
2. Select [Channel Copy] then press OK then the channel selection menu appears.
3. Use ▲/▼/◀/▶ to select a channel then press OK to select the target channel(s). You can cancel the selected channel by pressing OK.
4. Select [OK] then press OK to confirm your selection.

Copying from the Scheduled Data of the Day

You can copy the scheduled day of the week to another day of the week, weekday and weekend.

1. Select the day of week that you want to copy.
2. Select [Day Copy] then press OK then the channel selection menu appears.
3. Use ▲/▼/◀/▶ to day of the week then press OK to select the target date(s). You can cancel the selected channel by pressing OK.
4. Select [OK] then press OK to confirm your selection.

Normal

Settings concerning normal recording.

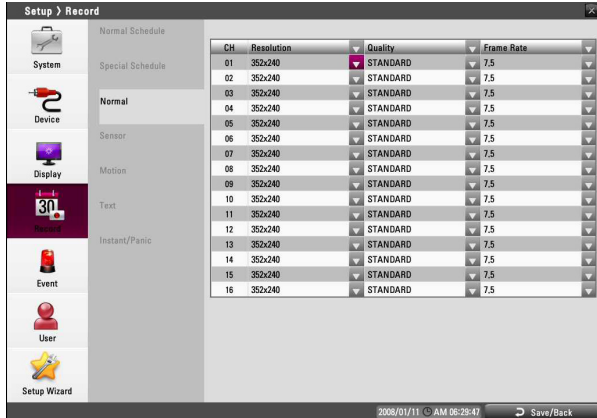

- Ch: Displays the channel number.
- Resolution: Selects the recording resolution.
- Quality: Selects the recording picture quality.
- Frame Rate: Selects the frame rate. The frame rate is the number of recorded frames per second. According to resolution, the frame rate is set automatically.

Sensor

Settings concerning sensor recording.

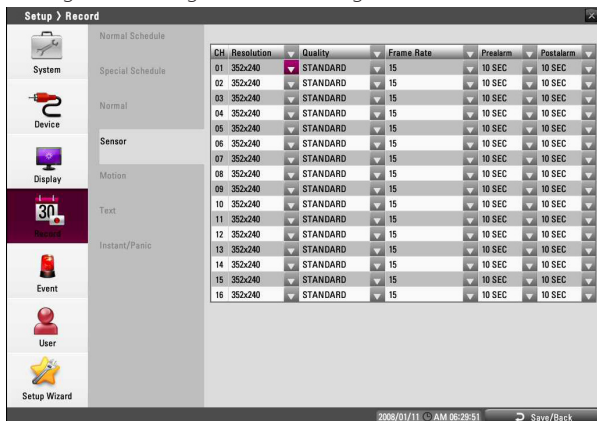

- Ch: Displays the channel number.
- Resolution: Selects the recording resolution.
- Quality: Selects the recording picture quality.
- Frame Rate: Selects the frame rate. The frame rate is the number of recorded frames per second. According to resolution, the frame rate is set automatically.
- Prealarm: Specify the pre-event recording time. When the Event signal is detected, the DVR records the data before the event during the setting time.
- Postalarm: Specify the post-event recording time. When the Event signal is detected, the DVR records the data after the event during the setting time.

Motion

Settings concerning motion recording.

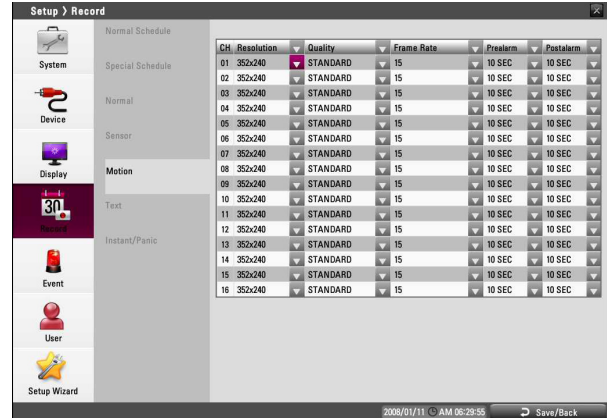

- Ch: Displays the channel number.
- Resolution: Selects the recording resolution.
- Quality: Selects the recording picture quality.
- Frame Rate: Selects the frame rate. The frame rate is the number of recorded frames per second. According to resolution, the frame rate is set automatically.
- Prealarm: Specify the pre-event recording time. When the Event signal is detected, the DVR records the data before the event during the setting time.
- Postalarm: Specify the post-event recording time. When the Event signal is detected, the DVR records the data after the event during the setting time.

Text

Settings concerning text recording.

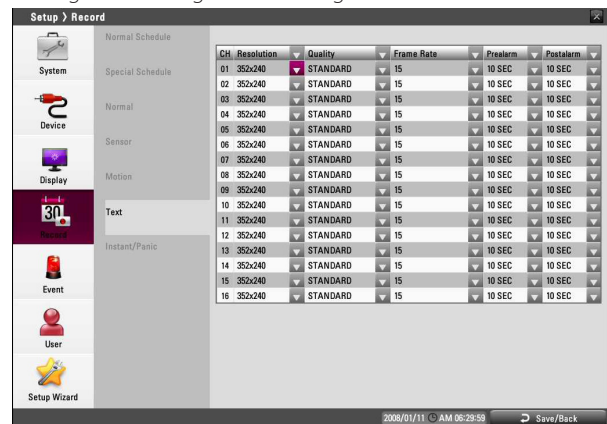

- Ch: Displays the channel number.
- Resolution: Selects the recording resolution.
- Quality: Selects the recording picture quality.
- Frame Rate: Selects the frame rate. The frame rate is the number of recorded frames per second. According to resolution, the frame rate is set automatically.
- Prealarm: Specify the pre-event recording time. When the Event signal is detected, the DVR records the data before the event during the setting time.
- Postalarm: Specify the post-event recording time. When the Event signal is detected, the DVR records the data after the event during the setting time.

Instant/Panic

Settings concerning instant/panic recording.

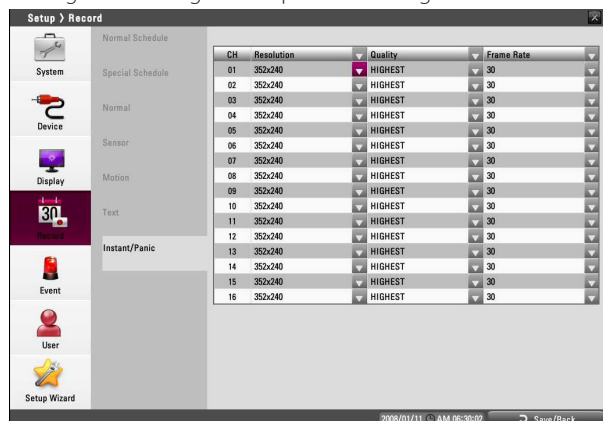

- CH: Displays the channel number.
- Resolution: Selects the recording resolution.
- Quality: Selects the recording picture quality
- Frame Rate: Selects the frame rate. The frame rate is the number of recorded frames per second. According to resolution, the frame rate is set automatically.

NOTE

Instant is single-channel setting and Panic is multi-channel setting.

Event settings

Sensor

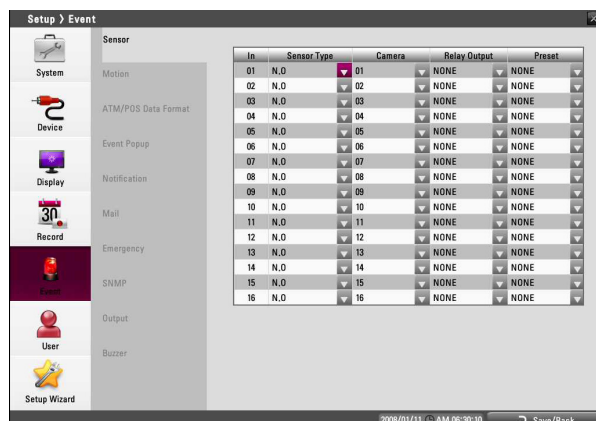

- In: Displays the number of the ALARM-IN terminal.
- Sensor Type: The sensor state can be set to either N.O. (Normally Open) or N.C. (Normally Closed).
- Camera: Select the camera channel connected to the ALARM-IN terminal.
- Relay Output: Select the alarm (relay) output number for the RELAY-OUT terminal for the output alarm (relay) signal.
- Preset: Select the preset number. When the input is activated, the camera moves to the selected preset position and the picture of the camera in that position appears on the monitor.

Motion

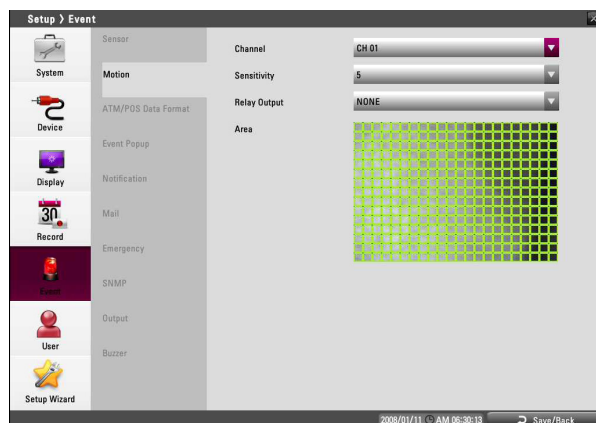

- Channel: Select the channel to set motion detection.
- Sensitivity: Set the level of sensitivity for the created motion detection area. Sensitivity can be set from level 1 to 10 or OFF.
- Relay Output: Select the number of the RELAY-OUT terminal for the output alarm (relay) signal when motion is detected.
- Area: Select the desired motion detection area on the preview window screen.
 - ▲/▼/◀/▶: Moves the yellow cell box to another cell zone.
 - OK: Selects or cancels the motion detection area at the current cell position.
 - Press BACK to exit the settings.

NOTE

- You can select the motion detection area by using the mouse.
 - To select the area: Drag & drop a cell to the right to select the motion detection area.
 - To cancel area: Drag & drop a cell point of a selected cell area to the left to cancel the motion detection area.
- In the condition that illumination is low and the outline of object is not clear enough to see, regardless of sensitivity, Motion Event may not happen. You must check Motion Event before setting.

ATM/POS Data Format

The DVR can be set to react to text input from devices such as ATMs (Automated Teller Machines) and POS (Point of Sale; i.e., cash registers). This screen allows you to configure the DVR for your input device.



- Input Channel: Select the mapping camera channel.
- Transaction Start: Enter a Transaction Start string. Refer to the device manufacturer's documentation for the text string that the device first sends when a transaction starts.
- Transaction End: Enter a Transaction End string. Refer to the device manufacturer's documentation for the text string that the device sends when a transaction ends.
- Delimiter: Enter the character(s) that the device uses to indicate the end of a line. Refer to the device manufacturer's documentation for Line Delimiter character(s).
- Ignore String: Enter the any strings of text that you want the DVR to ignore. Refer to the device manufacturer's documentation for text strings that the device sends during transactions, so you will know which ones you do not want recorded.
- Time Out: Select the Recording end time.

- Relay Output:
 - 01 to 04: Outputs the alarm (relay) signal via the RELAY-OUT terminal. When the DVR detects text input, it triggers output signals on all the associated RELAY-OUT connectors.
 - NONE: Not used.

NOTE

ATM/POS Recording Information.

Option setting	ATM/POS Recording Action
When the Transaction Start and Transaction End options are set.	Recording is started automatically when the Transaction start data is detected. When the Transaction end data is detected, the recording is stopped after post-alarm time.
When the Transaction Start and Transaction End option is not set.	Recording is started automatically when the transaction data is detected. When the transaction data is not detected, the recording is stopped after post-alarm time and the time you set in the Time Out option.

Event Popup

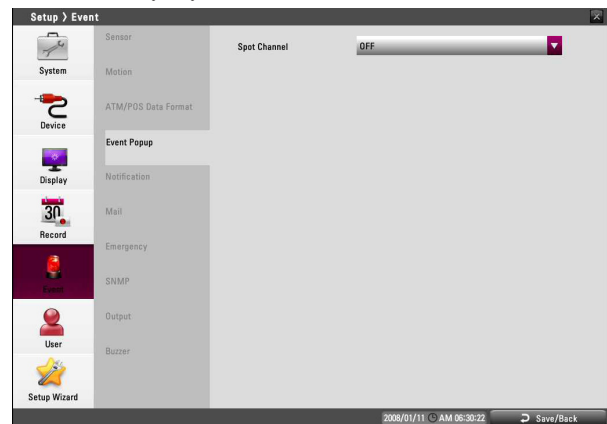

- Spot Channel: Select the event type for the spot monitor display when the event is activated.

Notification

Marks up when you want to activate the selected option. If the selected notification option is activated, the device will notify the user about the information of selected option by E-mail.

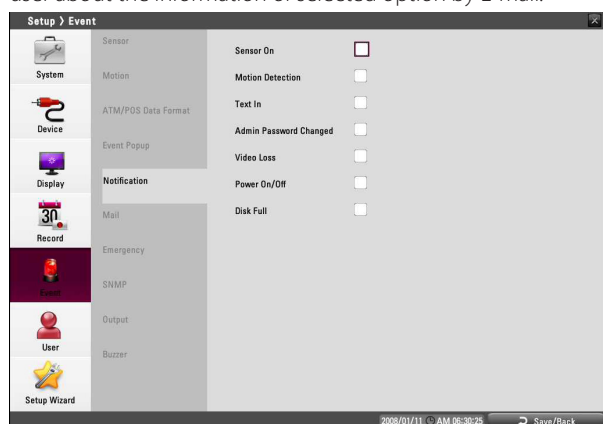

- Sensor On: Sends an e-mail when a sensor has occurred.
- Motion Detection: Sends an e-mail when a motion detection has occurred.
- Text In: Sends an e-mail when a text input is detected.
- Admin Password Changed: Sends an e-mail when the administrator password has been changed.
- Video Loss: Sends an e-mail when a video signal from the camera has stopped because of a cable disconnection or malfunction of a camera.
- Power On/Off: Sends an e-mail when power is on or off.
- Disk Full: Sends an e-mail when the HDD has fully recorded.

Mail

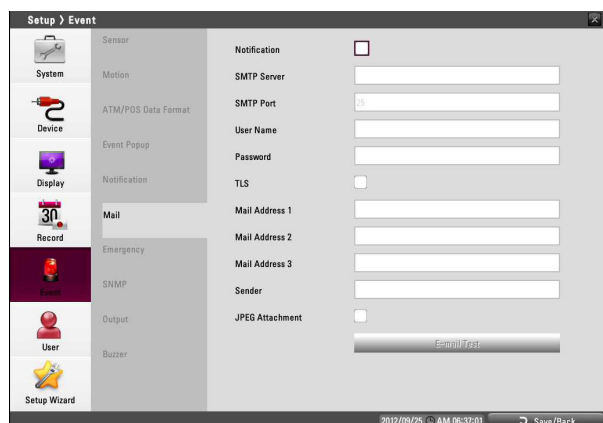

- Notification: Mark up to be notified the unit's operating information according to notification settings by e-mail.
- SMTP Server: Enter the SMTP Server address. If notification option is not mark up and the SMTP server option is empty, the SMTP Port, User Name, Password and TLS options cannot be set.
- SMTP Port: Enter the SMTP Port Number. Typically the port used for SMTP is 25. However in some cases it is better to change this port number for added flexibility or security. You can edit this port between 1 and 65535.
- User Name: Enter the user name.
- Password: Enter the password.
- TLS: Mark up if you use the TLS (Transport Layer Security) function.

- Mail Address (1 to 3): Enter the mail address. You can input up to 3 e-mail addresses.
- Sender: Enter the sender.
- JPEG Attachment: Click the check box to send a mail which want to attach a JPEG file.
- E-mail Test: Select [E-mail Test] to test sending an e-mail.

NOTE

- The SMTP server, SMTP port no., user name or password settings are optional. The DVR can send e-mail directly without the use of an SMTP server or MTA (message transfer agent). In certain cases all e-mail should be forwarded to a specific SMTP server. Specify the server host name or IP address in such a case. For more detail on SMTP setup, ask your network administrator and/or mail service provider.
- [JPEG Attachment] option is operated when event of [Sensor In], [Motion Detection] and [Text In] is occurred.

Emergency

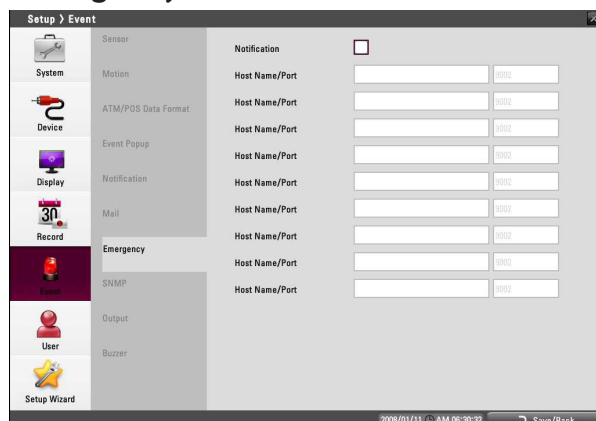

- Notification: Mark up to be notified the emergency agent about the unit's operating information according to your notification settings.
- Host Name/Port: Enter the Host Name and port number of the emergency agent program. The factory default port for this function is 9002. However in some cases it is better to change this port number for added flexibility or security. You can edit this port between 1025 and 65535. You can set up to 9 Host Name and port numbers.

SNMP

The Simple Network Management Protocol (SNMP) is an application protocol to exchange the management information of network devices.

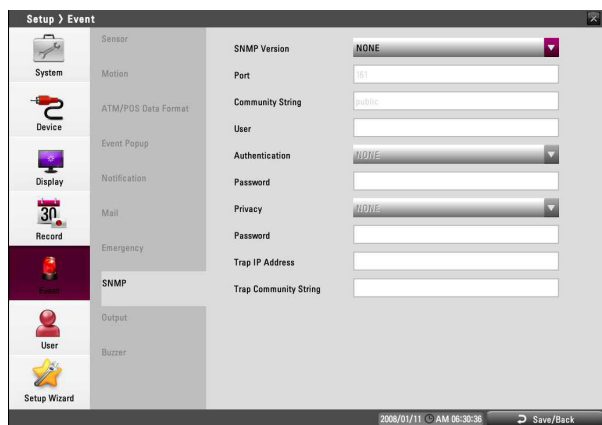

- **SNMP Version:** Selects a SNMP version if SNMP is allowed to access to this device.
- **Port:** Enter the number for SNMP port.
- **Community String (V2 only):** Specifies the SNMP management community in which you want to enable this system (e.g. lgecommunity or public).
- **User (V3 only):** Enter the security name for the SNMP.
- **Authentication (V3 only):** Select a mode for the SNMP Authentication. (MD5 or SHA)
- **Password (V3 only):** Enter the password for the SNMP Authentication.
- **Privacy (V3 only):** Select a privacy mode for the SNMP Authentication. (DES or AES)
- **Password (V3 only):** Enter the password for the privacy mode.
- **Trap IP Address:** Specifies the IP address of the computer you intend to use as your network management station and to which SNMP traps will be sent.
- **Trap Community String:** Specifies the SNMP trap community in which you want to enable this system (e.g. lgecommunity or public).

Output

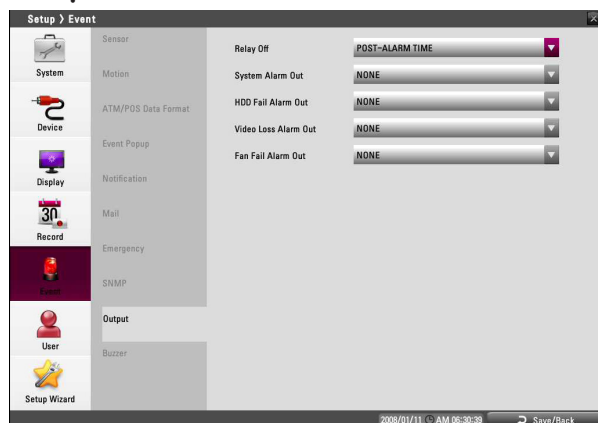

- **Relay Off**
 - **ALARM ACKNOWLEDGE:** Use the ALM.OFF button to stop alarm.
 - **POST-ALARM TIME:** The alarm is stopped after post-alarm time.
- **System Alarm Out:** Outputs the alarm (relay) signal via the selected alarm out terminal number when the system has some problem. If you do not use this function, select [NONE] option.
- **HDD Fail Alarm Out:** Outputs the alarm (relay) signal via the selected alarm out terminal number when the HDD is failed. If you do not use this function, select [NONE] option.
- **Video Loss Alarm Out:** Outputs the alarm (relay) signal via the selected alarm out terminal number when a video signal from the camera has stopped because of a cable disconnection or malfunction of a camera. If you do not use this function, select [NONE] option.
- **Fan Fail Alarm Out:** Outputs the alarm(relay) signal via the selected alarm out terminal number when the fan is failed. If you do not use this function, select [NONE]option.

Buzzer

Marks up when you want to activate the selected option.

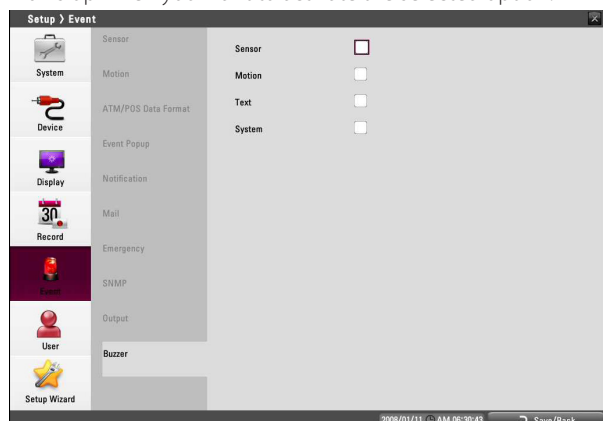

- Sensor: Makes a sound when a sensor occurs.
- Motion : Makes a sound when a motion is detected.
- Text: Makes a sound when the DVR detects text input.
- System: Makes a sound when a cooling fan is not activated or the HDD has bad sector.

NOTE

- Data cannot be saved in HDD which is occurred bad sector. But if HDD is installed more than 2 on this unit, data is saved in other normal HDD.
- When HDD has bad hold, can not operate normally. Replace the HDD immediately .

User settings

Group Authority

You can register a new user group with various access rights.

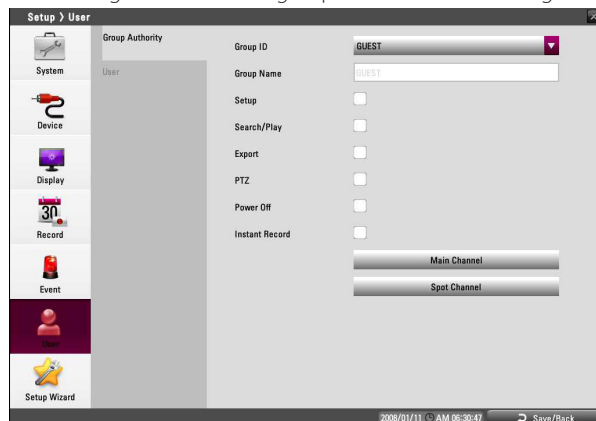

- Group ID: Select the group ID to assign authority.
 - GUEST: The GUEST group has the limited authority of the system. Users in this group are available to see the live image and to set the covert function of the Main or Spot channel.
 - ADMINISTRATOR: The ADMINISTRATOR group has the unlimited authority of the system. Users in this group are available to use all of the functions.
 - [Group 01] to [Group 08]: Users in this group are available to set the authority of the function manually.

NOTE

The GUEST and ADMINISTRATOR group are set initially for the authority. You cannot change the initial settings and group name (GUEST and ADMINISTRATOR).

- Group Name: If you select one of the group numbers from the Group ID option, you can register the group name. Enter the group name.
 - Setup, Search/Play, Export, PTZ, Power Off, Instant Record: Set the authority for the selected group. Mark up the option to activate it.
- Main Channel/Spot Channel: Selects the channel to allow the operation for the group user. The LG logo is displayed on the covert channel(s).

User

You can set the user name for the selected User ID.

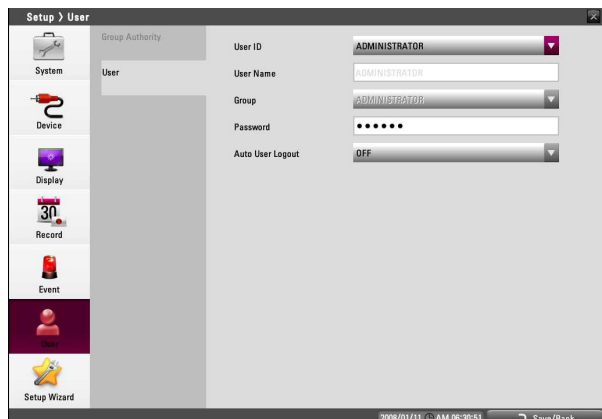

1. Select [User ID] from the drop-down list.
2. Enter the user name of the selected user ID.
3. Select the user group from the drop-down list.
4. Enter the Password.
5. Select the auto user logout time from the drop-down list.
6. Press BACK button to display the confirmation window.
7. Select [OK] to save the setting or [Cancel] to cancel the setting.

NOTE

- It is strongly recommended that you change the password of the administrator for the protection of the security of personal information. Do not leave 000000 as the default password. Make sure that you keep your password and write it down in a safe place so that you do not forget it.
- If you set the user ID to [ADMINISTRATOR], you cannot change the [User Name] and [Group] option but you can change the password.
- The user name and password are case-sensitive.
- The password must be entered more than 4 characters.

Setup Wizard settings

The Setup Wizard appears on the screen when you turn on the unit for the first time or select [Setup Wizard] on the Setup menu. You can set the system name, display language, date, time, network settings, recording schedule and recording mode on the initial setup wizard.

NOTE

If you run the Setup Wizard when DVR Setup has already been completed, the data previously configured could be deleted.

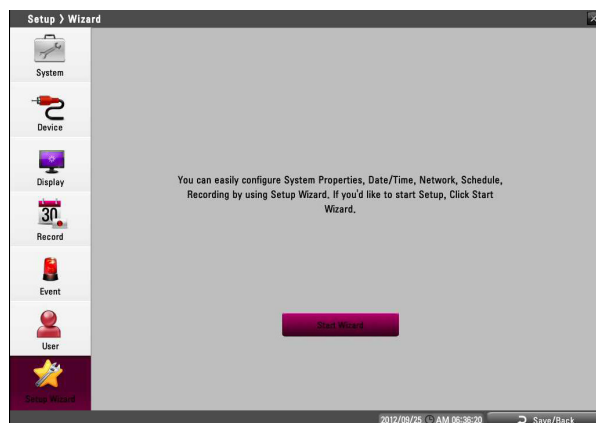

Step 1

Set the system name and display language.

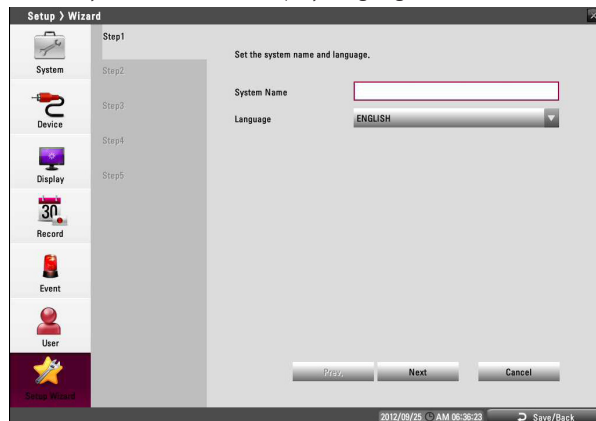

- System Name: Enter the system name by using alphabetic letter, numeric digit and symbols up to 21 characters.
- Language: Select a language for the setup menu and information display.

Step 2

Set date and time.

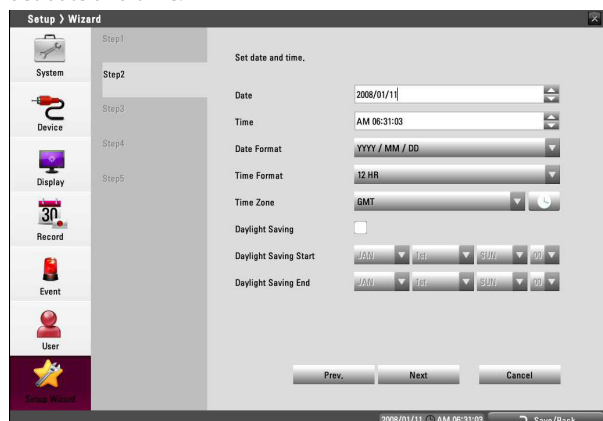

- Date: Select the current year, month and day.
- Time: Select the current time.
- Date Format: Select the date display format.
- Time Format: Select the time display format.
- Time Zone: Select the time zone in the area where the DVR is installed.
- Daylight Saving: Mark up when you use the daylight saving function.
- Daylight Saving Start: Select the Daylight Saving start time.
- Daylight Saving End: Selecting the Daylight Saving end time.

Step 3

Set network address for LAN ports.

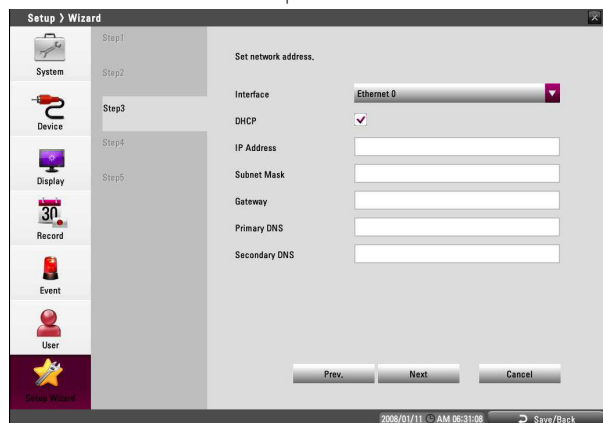

- Interface: Select a LAN port you want to use (Ethernet 0).
- DHCP: Select this option when a DHCP server is installed on the network to allow IP address assignment. With this setting, the IP address is assigned automatically.
- IP Address: Enter the IP address.
- Subnet Mask: Enter the subnet mask address.
- Gateway: Enter the gateway address.
- Primary DNS: Enter the Primary domain name server that translates the hostnames into IP address.
- Secondary DNS : Enter the Secondary DNS server address that backups the Primary DNS.

Step 4

Set recording schedule.

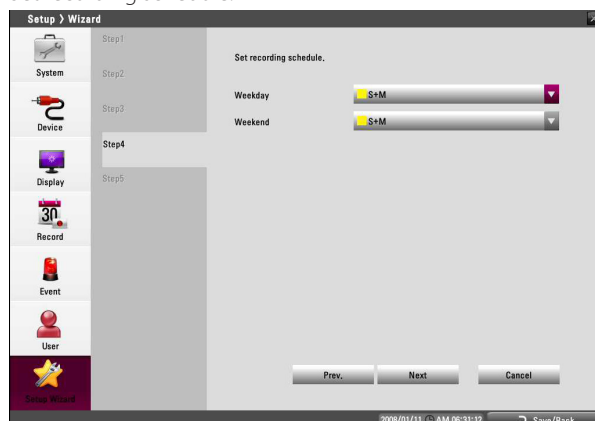

- Weekday: Sets the recording mode to weekday (Mon-Fri).
- Weekend: Sets the recording mode to weekend (Sat-Sun).

Step 5

Set recording mode for the Continuous and Event recording.

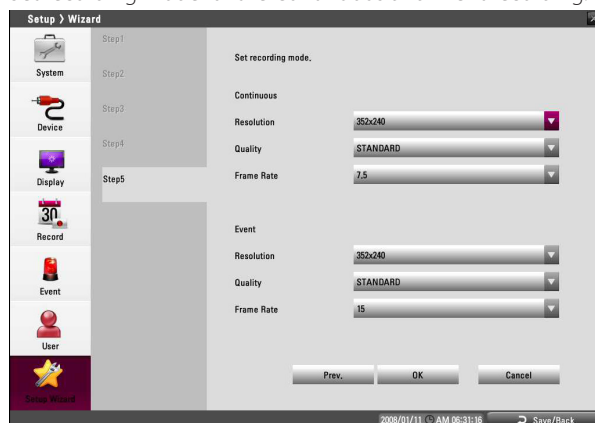

- Resolution: Selects the recording resolution.
- Quality: Selects the recording picture quality.
- Frame Rate: Selects the frame rate. The frame rate is the number of recorded frames per second. According to resolution, the frame rate is set automatically.

4 Operation

Instant Recording

Images from a camera will be recorded on the built-in hard disk. Ensure all the cameras are connected and that time and date have been set correctly.

Before you start recording, first check the repeat recording settings in the recording menu of the system setup, and then make the recording settings.

1. Press the REC button and then press the channel button you want to record. The recording type indicator turns gold on the selected channel screen of the main monitor.

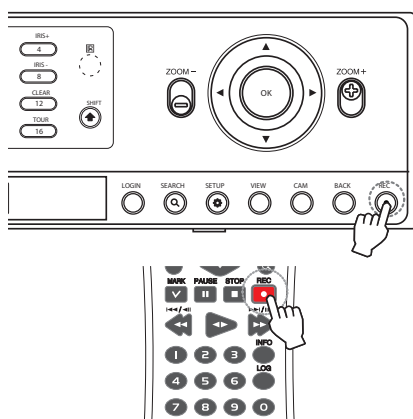

2. Press the REC button and then press the channel button you want to stop recording. If you stop instant recording, the recording mode will be changed into the scheduled recording mode (Continuous/ Sensor / Motion records). If the schedule is not set, the button indicator turns off and the recording type indicator turns gray on the selected channel screen of the main monitor.

! NOTE

- External recording devices can be used as copy areas for images recorded on the hard disk. It is impossible to record images on the external recording devices directly.
- You can record instantly with the left mouse button.
 1. Move the cursor to the desired channel screen on the main monitor.
 2. Click the recording type indicator with the left mouse button and recording starts. Click it once again and the instant record stops and the recording type indicator will be changed into the scheduled recording mode (Continuous / Sensor / Motion record). If the schedule is not set, the recording type indicator turns gray.
- You can use the instant recording also for the channels scheduled such as sensor, motion or continuous.
- Once you stop instant recording, the recording type indicator will be changed to the scheduled recording mode.
- You can not record the Instant and Continuous recording in following conditions.
 - A HDD is not attached.
 - A HDD is not formatted.
 - The channel has no video input for display.
 - Overwrite is set to "OFF".
 - The schedule (Sensor/Motion) record is not set.
- Priority of record.
Instant record > Sensor record > Motion record > Continuous record.
- The Warning message is displayed when the HDD problem occurs during the recording.

Panic Recording

You can record the all channels at the same time.

This function is activated for a live channel only.

1. Press and hold the REC button until the Recording Type indicator turns gold on the all live channel screens. The DVR will start recording.
2. Press and hold the REC button until the Recording Type indicator turns gray on the all live channel screens. The DVR will stop recording.

Instant Playback

It is possible to play a recorded image without stopping recording.

1. Select a channel you want to playback.
2. Press ◀▶ (Play) button to play a recorded image of the previous 1 or 2 minutes of recording. The playback image will be displayed on the full screen window.
3. Press ■ (STOP) button to stop the playback.

Search and Playback

The various search functions of this unit can be used to go to the beginning of the desired picture. Press SEARCH to display the search menu.

Date and Time Search

Use to search recorded pictures by specifying date, hour and minute.

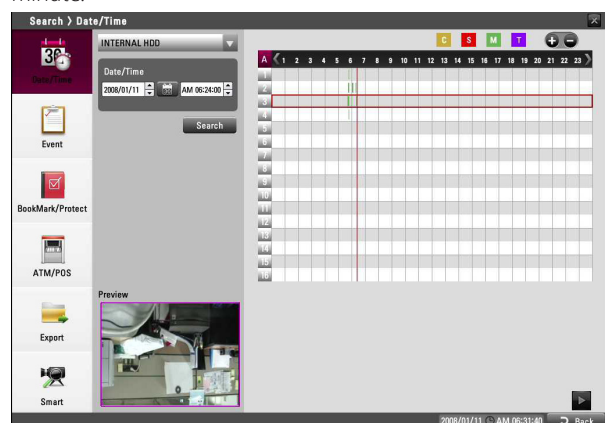

1. Press SEARCH or click the 🔍 icon on the System Control Bar and [Search] menu appears.
2. Use ▲/▼ button to select the [Date/Time] icon then press OK.
3. Select the desired source device.
 - INTERNAL HDD: Plays back or searches recorded contents of the internal HDD device.
 - Source Device: Plays back or searches backup contents of the source device.
4. Set the year, month, date and time.
 - ◀/▶: Moves to the previous or next column.
 - ▲/▼: Changes the value at the current position.
 - OK: Selects the column or confirms the setting.
5. Select the [Search] icon then press OK. The search result is displayed.
6. Use ▲/▼ button to select the channel and press OK. Repeat this step to select the other channels.

7. Press ◀▶ (Play) button or click ▶ button to start playback. The picture(s) is (are) displayed on the main monitor.
8. Press STOP (■) to stop playback and return to the search menu.
9. Press BACK repeatedly to exit the [Date/Time] menu.

Using the calendar icon to select a date

1. Select the 📅 icon then press OK.
2. Press BACK to move to the [▲] or [▼] option selecting a year and a month.
3. Press OK repeatedly to select a desired year and month.
4. Use ▲/▼/◀/▶ to select a date then press OK.
5. Select [OK] button and press OK to confirm the settings.

NOTE

- While the backup is in progress, you can not search the data on the backup device.
- Do not remove the external USB device from the USB device whilst the backup search is in progress. It may cause a malfunction.
- Recorded data shown on the time graph will be displayed in different colors depending on the recording type.
 - Gold: Continuous recording.
 - Red: Sensor recording.
 - Green: Motion-detection recording.
 - Gray: No recording.
 - Violet: ATM/POS recording.
- Use + - button to view the detailed time by 6 hour intervals.
- If you do not select the channels in the Date/Time search, playback is implemented as current main monitor screen mode.

Event Search

Search a recorded picture by date and type of event.

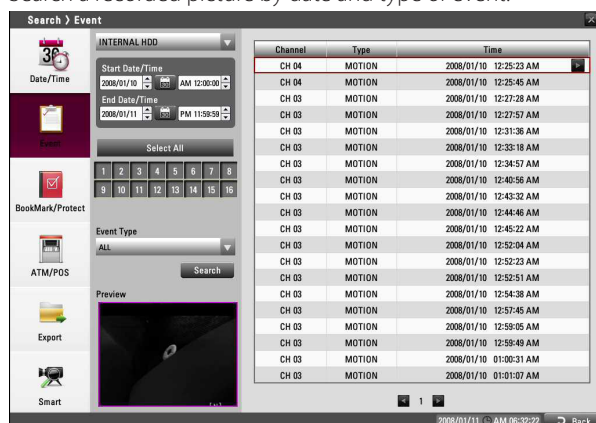

1. Press SEARCH or click the 🔍 icon on the System Control Bar and [Search] menu appears.
2. Use ▲/▼ button to select the [Event] icon then press OK.
3. Select the desired source device.
4. Set the year, month, date and time.
 - ◀/▶: Moves to the previous or next column.
 - ▲/▼: Changes the value at the current position.

- OK: Selects the column or confirms the setting.
5. Use ▲/▼/◀/▶ button to select the channel and press OK button to confirm the selection. If you want to select the all channels, mark up the [Select All] option.
 6. Select the [Event Type] from the drop-down list.
 7. Select the [Search] button then press OK. The event list menu appears. You can see the images through preview screen if you select a data in Event list.
 8. Select a recording data on the event list then press ◀▶ (Play) button or click ▶ button to play back the selected data. The picture is displayed on the main monitor.
 9. Press STOP (■) to stop playback and return to the event list menu.
 10. Press BACK repeatedly to exit the event search menu.

Bookmark/Protect Search

Searches the recorded data included a bookmark or the protected section.

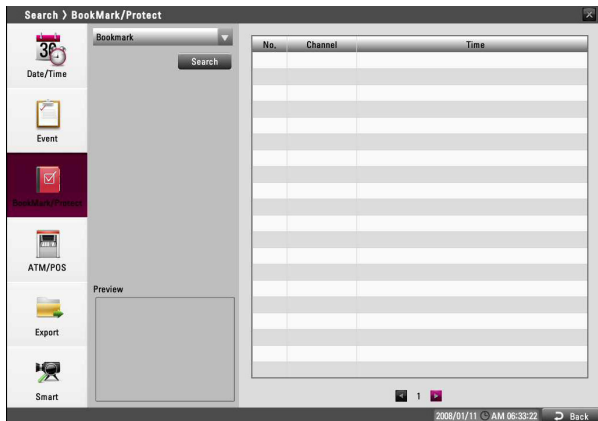

1. Press SEARCH or click 🔍 icon on the System Control Bar and [Search] menu appears.
2. Select the [Bookmark] or [Protect] from drop-down list.
3. Select the [Search] icon then press OK. The Bookmark (or Protect) list appears.
4. Use ▲/▼ button to select a bookmark (or protect) then press OK.
5. Press ◀▶ (Play) or click ▶ button to play back the selected data.

NOTE

- Backup data cannot be played back by a Bookmark/Protect Search.
- You can register a bookmark only in the single channel playback.
- If you want to delete the bookmark/protect on the list, select the recording data and select ✕ button and press OK.

ATM/POS Search

Search the recorded text information by ATM/POS device. This function is available with backup data of the internal or external HDD only.



1. Press SEARCH or click 🔍 icon on the System Control Bar and [Search] menu appears.
2. Use ▲/▼ button to select the [ATM/POS] icon then press OK.
3. Select the desired source device.
4. Set the year, month, date and time.
 - ◀/▶: Moves to the previous or next column.
 - ▲/▼: Changes the value at the current position.
 - OK: Selects the column or confirms the setting.
5. Use ▲/▼/◀/▶ button to select the channel and press OK button to confirm the selection. If you want to select the all channels, mark up the [Select All] option.
6. Set the detail search options.
 - Number: Displays the preset number.
 - Option Item: Enter the text to search what you want.
 - AND/OR: Select the Boolean operator when you use the Text search and Number search function simultaneously.
 - Value: Enter the number to search what you want.
 - >, <, <=, =, >= (compare symbols): Select the compare symbol for number search.

>	To find the lower value than the input value.
<	To find the higher value than the input value.
<=	To find the higher or even value than the input value.
=	To find the even value than the input value.
>=	To find the lower or even value than the input value.

7. Select the [Search] icon then press OK.
8. Select a text data on the list then press ◀▶ (Play) button or click ▶ button to play back the selected data. The picture is displayed on the main monitor.
9. Press STOP (■) to stop playback and return to the ATM/POS search list menu.

Export Search

Searches an exported data in the external device. Check the export device before you proceed.

If you want to use this function, you have to connect the external device otherwise the warning message will be displayed.

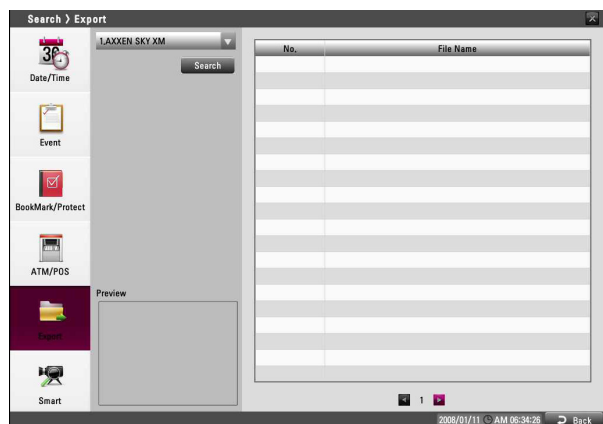

1. Press SEARCH or click icon on the System Control Bar and [Search] menu appears.
2. Use ▲/▼ button to select the [Export] icon then press OK.
3. Select the desired source device.
4. Select the [Search] icon then press OK. The exported file list menu appears.
5. Select the exported file on the exported file list then press ◀▶ (Play) button or click to start playback. The picture is displayed on the main monitor.
6. Press STOP (■) to stop playback and return to the exported file list menu.

NOTE

The exported data with password cannot preview the image. When you play the exported data with password, logon screen appears. To unlock the data, enter the password.

Smart Search

You can be searched the recorded data by specifying the motion detection conditions.

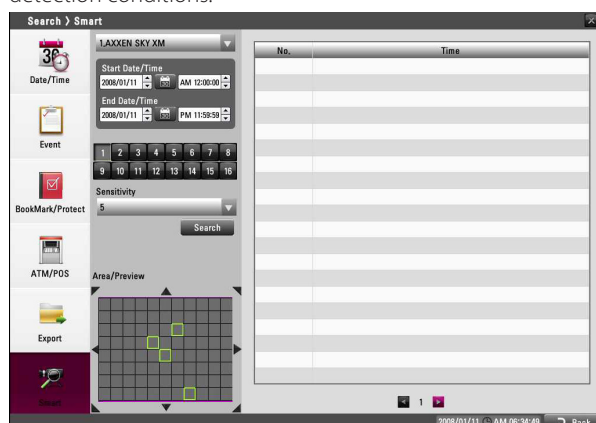

1. Press SEARCH or click icon on the System Control Bar and [Search] menu appears.
2. Use ▲/▼ to select the [Smart] icon then press OK. The smart search menu is displayed.
3. Select the desired source device.
4. Specify the Start Date/Time, End Date/Time, Channel and Sensitivity options.
 - ▲▼◀▶: Moves to the options.
 - ▲/▼: Changes the value at the current position.
 - OK: Selects option or confirms the setting.
5. Set the motion mask setting. The area switches between active and inactive each time you press OK. Click the one point and drag & drop the end point to select the motion using the mouse. The active areas are indicated in red.
6. Select a motion direction button.
7. Press BACK repeatedly to exit the mask setting.
8. Select [Search] then press OK. The search result is displayed on the list.
9. Select the recording data on the list then press ◀▶ (Play) button or click button to play back the selected data. The picture is displayed on the main monitor.
10. Press STOP (■) to stop playback and return to the smart list menu.
11. Press BACK repeatedly to exit the Smart Search menu.

Using the playback control menu

You can use various playback function using playback control menu.

1. Play a data recorded.

Playback control menu appears at the bottom of the screen.

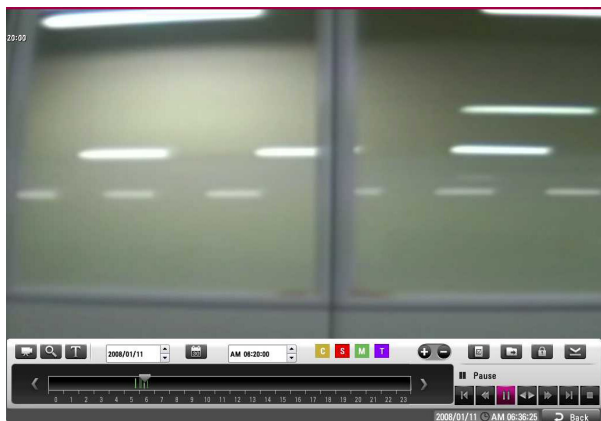

	Selects the camera you want to play.
	Enlarge the current screen using the digital zoom function
	Displays or disappears the text information if the recording data includes text data.
	Displays the date of the data recorded. You can choose the date you want to see.
	Displays the time of the data recorded. You can choose the time you want to see.
	Displays the record mode.
	Increases or decreases the time interval of the Time Line.
	Registers a bookmark.
	Displays the [Export] menu.
	Displays the [Protect] menu.
	Minimizes the Playback control menu.
	Displays the current position, recording mode and recording section.
	Playback control buttons

NOTE

The exported data with password cannot preview the image. When you play the exported data with password, logon screen appears. To unlock the data, enter the password.

Using the Protect function

This function allows you to protect the recorded data against being automatically overwritten.

How to select Protect section.

1. Click icon on the Playback control menu. The [Protect] menu appears.



2. If you want to change the time period, select starting and ending point of a part that you want to protect.
3. Click the [OK] icon and the part is protected. The protected data is shown shaded in the timeline area.

NOTE

- Protect function dose not work when two or more protected parts overlap or when no data does not exist in the selected part.
- The protected section can be released when the time is set in the past or by Auto delete function.

How to release the Protect section.

1. Select any position in the protected section on the Playback control menu.
2. Click the icon. The confirm message appears.
3. Click the [OK] icon. The protected data is released.

5 Troubleshooting

Check the following guide for the possible cause of a problem before contacting service.

Symptoms	Cause & Solution
The system power does not turn on.	Check the power cable is connected correctly.
	Check the input voltage is correct.
	If the system power does not turn on even if the power cable is connected correctly, please contact the service center.
The system power is turned on but no video data is displayed on the monitor.	Check the monitor power cable is connected properly.
	Make sure the monitor is turned on.
	Check the video output cable of the LG DVR is properly connected to the monitor.
	Unplug the power cable and plug it in again.
The camera numbers are displayed on the screen but the camera images are not displayed.	Check the camera video output is connected to the DVR system correctly.
	Check the power cable on the camera is connected correctly.
	Check there is no problem with the video cable connection between the camera and the LG DVR system.
	Turn off the DVR system and turn it on again.
The camera video is shown on the screen but the system does not record the video.	Check the recording mode in the record setting menu.
	Check the HDD detection status in the System Information window. If the HDD detection status is abnormal, check the HDD formatting and the connection of the HDD.
	Check the recordable disk space in the HDD.
	Check the overwrite option in the setup menu for overwrite recording.
It is impossible to search through the recorded video.	Check if there is recorded video data at the time that you are trying to search on the table.
	If there is no recorded video data, check the recording mode in the record setting menu.
	Check the HDD detection status in the system information window. If the HDD detection status is abnormal, check the HDD formatting and the connection of the HDD.
	Check the user type. The search function is not available for an unauthorized user.

Symptoms	Cause & Solution
Audio data recorded with video data is not playing.	Check the audio recording option is correctly set for the camera you wish to record audio.
	Check the speaker and audio (line input) on the rear of system are connected correctly.
	Check the connected speaker is working properly.
The colors of some camera videos are strange or videos are displayed abnormally.	If the camera connected to the system has a problem, make sure whether the camera is damaged by trying to connect another camera to the video input jack.
	Check the video format setting of the unit is the same as the connected camera's video format. Depending on your region, the camera's video format can support either PAL or NTSC. Depending on the camera's video format, the video process can differ greatly, therefore it can be difficult to recognize the video data if the video format setting is different from the camera's video format.
There is a lot of (screen) noise accompanying the image.	Check if the video signal output from the camera has a problem. Ensure the camera is not damaged by trying another camera with a working video output.
	Check if the video cable connection between the camera and the DVR is cut, crosswired or shorted.
	Check if there is a high voltage wire around the video cable connection between camera and DVR system. It can cause interference and affect video quality.
	Check the video cable connection between the camera and the DVR system is the correct video cable. When a normal power-supplying cable is used instead of the video cable, screen noise can be generated.
	When the video is connected to various system and the video is being output from video distributor, the noise can be generated because the video signal may be weak. In this case, connect the video signal of that camera to DVR directly to confirm and solve this problem.
	If the distance between the camera and DVR is long, the noise may be generated on some camera channel. In this case, connect that video signal to the other video input connector of DVR to confirm this problem. If the noise is generated equally, please check the camera's ground connection and cable.
The connected sensor is not operating.	Check the type of sensor in the camera setting is the same as with the connected sensor.
	Check the system is set to use the sensor in the recording schedule window in the recording setting menu.
	Check the sensor is properly connected to the ALARM-IN.
The connected PTZ camera is not operating.	Check the system is set to use the PTZ camera in the camera setting menu.
	Check the power cable of the PTZ camera is properly connected.
	Check the signal cable of the PTZ camera is properly connected.
	Check the selected channel to control the PTZ camera.
	Check the user type. The PTZ camera control is not available for a normal user.

Symptoms	Cause & Solution
An E-mail sent from this product was not received.	E-mail reception failed without SMTP server setting. <ul style="list-style-type: none"> • Make sure the network is correctly set. • Make sure the mail address is input correctly. • Check the spam mail setting of the input mail address. (If you set the spam mail, some mails are deleted automatically or classified in the spam mail box) • Some of SMTP mail services do not support an E-mails from private SMTP servers. In this case use the public SMTP server.
	E-mail reception failed even if the SMTP server was set. <ul style="list-style-type: none"> • When the [Please check the SMTP information or internet cable] message is displayed. <ul style="list-style-type: none"> - Check the SMTP server address. - Check the SMTP port number. (Default setting is 25) - Check the network settings. • When the [Please check the authentication information] message is displayed. <ul style="list-style-type: none"> - Check the user name. - Check the password. • The mail reception failed without error message. <ul style="list-style-type: none"> - Check the receiver's mail address. - Check your E-mail is not classified as a spam mail on the receiver's mail setting.
The remote control does not work properly.	Check the batteries in the remote control.
	Check the ID setting for the remote control (See page 29).



NOTE

If you observe any of the following symptoms:

- Some of the front panel LEDs do not light.
- The DVR does not operate normally.

You can reboot the DVR as follows:

1. Turn off the DVR and turn it on again after a few seconds.
2. When the recorder does not work normally after rebooting, contact the service center.

6

Appendix

Recommended Devices

Recommended USB Memory list

No.	Maker	Model Name	Capacity
1	LG Electronics	XTICK SPIN	2 G
2	LG Electronics	XTICK UF1	32 G
3	Lexar	Jump Drive	1 G
4	Memorive	SLC	2 G
5	TRANSCEND	JF	16 G
6	SKYDRV	x2	2 G
7	SANDISK	Cruzer	16 G
8	Samsung Electronics	SUM-LSB8	8 G
9	Samsung Electronics	SUM-PSB	32 G

! NOTE

- Some USB memory devices other than the ones on the above table may not work properly, even if this DVR reads them.
- For the latest recommended USB list, please visit <http://www.lgecommercial.com>

Recommended External Device list

Device	Capacity	File system	Backup search function for the client program
USB HDD	Up to 2 TB.	FAT 32 (This file system is compatible with Windows and Linux system.)	Yes
E-SATA HDD	Up to 2 TB.	XFS (Linux file system) This file system is not compatible with Windows system.	No

! NOTE

The E-SATA device with the FireLynx Series of Malgn Technology is supported only for data storage. Other device or manufacture may cause a malfunction.

Supported function list for device

Device	Instant backup	Schedule backup	Export	Configuration Import/Export
USB memory	<input type="radio"/>	<input type="radio"/>	<input type="radio"/>	<input type="radio"/>
USB HDD	<input type="radio"/>	<input type="radio"/>	<input type="radio"/>	<input type="radio"/>
E-SATA HDD	<input type="radio"/>	<input type="radio"/>	<input type="radio"/>	<input type="radio"/>

! NOTE

If you use a USB memory stick or USB HDD for configuration import/export you must disconnect the other external USB devices.

Supported PTZ Camera list

Protocol Name	Maker	Pan/Tilt	Zoom	Focus	Iris	Preset	Tour	Setup
		Speed control						
LG_MULTIX	LG	YES	YES	YES	YES	YES	YES	YES
		YES	NO					
LG_MULTIX EXTENTION	LG	NO	YES	YES	YES	NO	NO	YES
		NO	NO					
LG_SD168	LG	YES	YES	YES	YES	YES	YES	YES
		YES	NO					
LG_LS903	LG	NO	NO	NO	NO	NO	NO	YES
		NO	NO					
LG_ZOOM	LG	NO	YES	YES	YES	NO	NO	YES
		NO	NO					
LPT_A100L	LG	YES	NO	NO	NO	NO	NO	NO
		NO	NO					
PELCO_D	PELCO	YES	YES	YES	YES	YES	YES	YES
		YES	NO					
PELCO_P	PELCO	YES	YES	YES	YES	YES	YES	YES
		YES	NO					
GANZ_DSCP	CBC	YES	YES	YES	YES	YES	YES	YES
		YES	YES					
GANZ_P360V1	CBC	YES	YES	YES	YES	YES	YES	NO
		YES	NO					
GE KALATEL_CYBERDOM	KALATEL	YES	YES	YES	YES	YES	YES	NO
		YES	NO					
PANASONIC_CS850	PANASONIC	YES	YES	YES	YES	YES	YES	YES
		YES	NO					
BOSCH_AUTODOME	BOSCH	YES	YES	YES	YES	YES	YES	NO
		YES	YES					
SAMSUNG_SCC	SAMSUNG	YES	YES	YES	YES	YES	YES	YES
		YES	NO					
SAMSUNG_E	SAMSUNG	YES	YES	YES	YES	YES	YES	YES
		YES	NO					

Time zones

Timezone name	Timezone Abbreviation	Timezone	DST
Eniwetok, Kwajalein	EK	-12:00	
Midway Island, Samoa	MIS	-11:00	
Hawaii	HAW	-10:00	
Alaska	ALA	-09:00	-08:00
Pacific Time (US and Canada); Tajuana	PST	-08:00	-07:00
Mountain Time (US and Canada), Chihuahua, La Paz, Mazatlan, Arizona	MST	-07:00	-06:00
Central Time (US and Canada), Saskatchewan, Guadalajara, Mexico City, Monterrey, Central America	CST	-06:00	-05:00
Eastern Time (US and Canada), Indiana (East), Bogota, Lima, Quito	EST	-05:00	-04:00
Atlantic Time (Canada), Caracas, La Paz, Santiago	AST	-04:00	
Newfoundland	NWF	-03:30	-02:30
Brasilia, Buenos Aires, Georgetown, Greenland	BBA	-03:00	
Mid-Atlantic	MAT	-02:00	
Azores, Cape Verde Islands	AZO	-01:00	
Greenwich Mean Time: Dublin, Edinburgh, Lisbon, London, Casablanca, Monrovia	GMT	0	+01:00
Amsterdam, Belgrade, Bratislava, Budapest, Ljubljana, Prague, Sarajevo, Skopje, Warsaw, Zagreb, Brussels, Copenhagen, Madrid, Paris, Berlin, Bern, Rome, Stockholm, Vienna, West Central Africa	AMS	+01:00	+02:00
Athens, Istanbul, Minsk	AIM	+02:00	+03:00
Bucharest, Cairo, Pretoria, Jerusalem, Harare, Pretoria	BCP	+02:00	+03:00
Helsinki, Riga, Israel, Kyiv, Sofia, Tallinn, Vilnius	HRI	+02:00	+03:00
Baghdad, Kuwait, Riyadh, Nairobi	BKR	+03:00	+04:00
Moscow, St.Petersburg, Volgograd	MSV	+03:00	+04:00
Tehran	THE	+03:30	+04:30
Abu Dhabi, Muscat, Baku, Tbilisi, Yerevan	ABT	+04:00	
Kabul	KAB	+04:30	
Ekaterinburg, Islamabad, Karachi, Tashkent	EIK	+05:00	
Bombay, Calcutta, Madras, New Delhi, Chennai, Kolkata	BCD	+05:30	
Almaty, Dhaka, Colombo, Astana, Sri Jayawardanapura, Novosibirsk	ADC	+06:00	
Yangon	MMT	+06:30	
Bangkok, Hanoi, Jakarta, Krasnoyarsk	BHJ	+07:00	
Beijing, Changqing, Hong Kong, Urumqi	BHU	+08:00	
Perth, Singapore, Taipei, Beijing, Chongqing, Hong Kong SAR, Urumqi, Kuala Lumpur, Irkutsk, Ulaan Bataar	SST	+08:00	
Osaka, Sapporo, Tokyo	OST	+09:00	
Seoul, Yakutsk	SYA	+09:00	
Adelaide, Darwin	ADA	+09:30	
Brisbane, Guam, Port Moresby	BGP	+10:00	
Canberra, Melbourne, Sydney	CMS	+10:00	
Hobart, Vladivostok	HVL	+10:00	
Magadan, Solomon Islands, New Caledonia	MSN	+11:00	+12:00
Auckland, Wellington	AWE	+12:00	
Fiji Islands, Kamchatka, Marshall Islands	FKM	+12:00	

Factory Default Configuration Settings

1st level	2nd level	3rd level	Default Value	Factory Default setting
System	Properties	System Name	NULL	YES
		Language	The option depends on the model.	YES
		Button Beep	OFF	YES
		Video Format	NTSC or PAL	NO
		Resolution	1024*768	NO
		Configuration Import	-	-
		Configuration Export	-	-
		Factory Default	-	-
	TCP/IP4	Interface	Ethernet 0	-
		DHCP	ON	YES
		IP Address	NULL	YES
		Subnet Mask	NULL	YES
		Gateway	NULL	YES
		Primary DNS	NULL	YES
		Secondary DNS	NULL	YES
	TCP/IP6	Interface	Ethernet 0	-
		Auto	ON	YES
		IP Address	NULL	YES
		Subnet Prefix Length	64	YES
		Gateway	NULL	YES
		Primary DNS	NULL	YES
		Secondary DNS	NULL	YES
	Network	TCP/IP Port No.	9001	YES
		Web Server Port No.	80	YES
		Audio Port No.	9003	YES
		Bandwidth Throttle	ALL / 100 Mbps	YES
		RTSP Port	554	YES
		DDNS Service	OFF	YES
		Host Name	NULL	YES
		Registered Host	NULL	YES
		Update	-	-
	Network Streaming	CH	-	-
		Resolution	352x240 (NTSC) / 352x288 (PAL)	YES
Quality		STANDARD	YES	
Frame Rate		7.5 (NTSC) / 6 (PAL)	YES	

System	Date/Time	Date	Current Date	NO
		Time	Current Time	NO
		Date Format	YYYY/MM/DD	YES
		Time Format	12 HR	YES
		Time Zone	The option depends on the model.	NO
		Daylight Saving	OFF	NO
		Daylight Saving Start	JAN, 1st, SUN, 00	NO
		Daylight Saving End	JAN, 1st, SUN, 00	NO
	NTP	NTP	OFF	YES
		Time Server	PUBLIC SERVER	YES
		Private Time Server	NULL	YES
		Sync. Interval	1 DAY	YES
		NTP Test	-	-
	Controller	IR Remote ID	1	YES
		Remote Controller ID	NONE	YES
	Update	Method	LOCAL	YES
		Device	-	YES
		FTP Server	-	YES
		Search	-	-
		No.	-	-
		File Name	NULL	-
		Update	-	-
		Check now for update	-	-
	Backup	Schedule	OFF	YES
		Device	-	YES
		Schedule Start	SUN, 12:00:00 AM	YES
		Time Range Date	Current Date	YES
		Time Range Start	SUN, 00:00	YES
		Time Range End	SUN, 00:00	YES
		Overwrite	ON	YES
		Estimate Size	-	-
		Start Backup	-	-
		Erase Media	-	-

Device	Camera	Ch	-	
		Name	CH 01 to CH 16	YES
		Audio	01 to 04, NONE	YES
	PTZ	Channel	CH 01	-
		Port	NONE	YES
		Control ID	0	YES
		Protocol	LG_MULTIX	YES
		Baud Rate	9600	YES
		PTZ Test	-	-
		ATM/POS	Interface Device	NONE
	Camera		CH 01	YES
	Baud Rate		9600	YES
	Data Bits		8	YES
	Stop Bits		1	YES
	Parity		NONE	YES
	Storage	Overwrite	ON	YES
		Full Warning	OFF	YES
		Auto Delete	OFF	YES
		Storage Saving	OFF	NO
		Format	-	-
		E-SATA	-	-
		Insert	-	-
		Eject	-	-
Display	OSD	Channel Name	ON	YES
		Channel Status	ON	YES
		Channel FPS	OFF	YES
		Channel Name (Spot)	ON	YES
		Font Size	12	YES
		Position	TOP	YES
	Sequence	Main Dwell Time	2 SEC	YES
		Spot Dwell Time	2 SEC	YES
	Video Adjustment	Channel	CH 01	-
		Brightness	50	YES
		Contrast	50	YES
		Color	50	YES
		Restore to Default	-	-

Record	Normal Schedule	Day	Current day of the week	NO
		Mode	S+M	NO
		Channel Copy	-	-
		Day Copy	-	-
	Special Schedule	List	Item 1	YES
		Name	NULL	YES
		Date	--/--	YES
		Mode	S+M	NO
		Delete	-	-
		Channel Copy	-	-
	Normal	CH	-	-
		Resolution	352x240 (NTSC) / 352x288 (PAL)	YES
		Quality	STANDARD	YES
		Frame Rate	7.5 (NTSC) / 6 (PAL)	YES
	Sensor	CH	-	-
		Resolution	352x240 (NTSC) / 352x288 (PAL)	YES
		Quality	STANDARD	YES
		Frame Rate	15 (NTSC) / 12.5 (PAL)	YES
		Prealarm	10 SEC	YES
		Postalarm	10 SEC	YES
	Motion	CH	-	-
		Resolution	352x240 (NTSC) / 352x288 (PAL)	YES
		Quality	STANDARD	YES
		Frame Rate	15 (NTSC) / 12.5 (PAL)	YES
		Prealarm	10 SEC	YES
		Postalarm	10 SEC	YES
	Text	CH	-	-
		Resolution	352x240 (NTSC) / 352x288 (PAL)	YES
		Quality	STANDARD	YES
		Frame Rate	15 (NTSC) / 12.5 (PAL)	YES
		Prealarm	10 SEC	YES
		Postalarm	10 SEC	YES
Instant/Panic	CH	-	-	
	Resolution	352x240 (NTSC) / 352x288 (PAL)	YES	
	Quality	HIGHEST	YES	
	Frame Rate	30 (NTSC) / 25 (PAL)	YES	

Event	Sensor	In	-	YES
		Sensor Type	N.O	YES
		Camera	01 to 16	YES
		Relay Output	NONE	YES
		Preset	NONE	YES
	Motion	Channel	CH 01	-
		Sensitivity	5	YES
		Relay Output	NONE	YES
		Area	All selected	-
	ATM/POS Data Format	Input Channel	01	-
		Transaction Start	NULL	YES
		Transaction End	NULL	YES
		Delimiter	CARRIAGE RETURN	YES
		Ignore String	NULL	YES
		Time Out	10 MIN	YES
		Relay Output	NONE	YES
	Event Popup	Spot Channel	OFF	YES
	Notification	Sensor On	OFF	YES
		Motion Detection	OFF	YES
		Text In	OFF	YES
		Admin Password Changed	OFF	YES
		Video Loss	OFF	YES
		Power On/Off	OFF	YES
		Disk Full	OFF	YES
	Mail	Notification	OFF	YES
		SMTP Server	NULL	YES
		SMTP Port	25	YES
		User Name	NULL	YES
		Password	NULL	YES
		TLS	OFF	YES
		Mail Address 1	NULL	YES
		Mail Address 2	NULL	YES
Mail Address 3		NULL	YES	
Sender		NULL	YES	
JPEG Attachment		OFF	YES	
E-mail Test		-	-	

Event	Emergency	Notification	OFF	YES
		Host Name	NULL	YES
		Port	9002	YES
	SNMP	SNMP Version	NONE	YES
		Port	161	YES
		Community String	public	YES
		User	NULL	YES
		Authentication	NONE	YES
		Password	NULL	YES
		Privacy	NONE	YES
		Password	NULL	YES
		Trap IP Address	NULL	YES
		Trap Community String	NULL	YES
	Output	Relay Off	ALARM ACKNOWLEDGE	YES
		System Alarm Out	NONE	YES
		HDD Fail Alarm Out	NONE	YES
Video Loss Alarm Out		NONE	YES	
Fan Fail Alarm Out		NONE	YES	
Buzzer	Sensor	OFF	YES	
	Motion Detection	OFF	YES	
	Text	OFF	YES	
	System	OFF	YES	
User	Group Authority	Group ID	GUEST	YES
		Group Name	GUEST	YES
		Setup	OFF	YES
		Search/Play	OFF	YES
		Export	OFF	YES
		PTZ	OFF	YES
		Power Off	OFF	YES
		Instant Record	OFF	YES
		Main Channel	All Enable	YES
		Spot Channel	All Enable	YES
	User	User ID	ADMINISTRATOR	YES
		User Name	ADMINISTRATOR	YES
		Group	ADMINISTRATOR	YES
		Password	"000000"	YES
Auto User Logout		OFF	YES	

Recording Time Table (250GB HDD)

Resolution (NTSC/PAL)	Quality	FPS		Recording Time (Hr)							
				Video (NTSC/PAL)				Video + Audio (NTSC/PAL)			
		NTSC	PAL	(8 CH, Video) NTSC/PAL	(16 CH, Video) NTSC/PAL	(8 CH, Video+Audio) NTSC/PAL	(16 CH, Video+Audio) NTSC/PAL	(8 CH, Video+Audio) NTSC/PAL	(16 CH, Video+Audio) NTSC/PAL		
352x240 /352x288	Lowest	30.0	25.0	699.75	711.50	349.88	355.75	650.89	661.04	325.44	330.52
		15.0	12.5	1119.60	1166.25	559.80	583.13	999.54	1036.55	499.77	518.28
		10.0	8.0	1393.23	1390.32	696.61	695.16	1212.05	1209.85	606.03	604.92
		7.5	6.0	1643.86	1414.80	821.93	707.40	1397.40	1228.34	698.70	614.17
		5.0	5.0	1856.71	1464.36	928.35	732.18	1548.28	1265.54	774.14	632.77
		3.0	3.0	2150.10	1506.01	1075.05	753.00	1747.08	1296.52	873.54	648.26
		1.0	1.0	2412.81	1613.97	1206.40	806.98	1916.65	1375.75	958.33	687.87
	Low	30.0	25.0	371.19	362.32	185.60	181.16	356.98	348.76	178.49	174.38
		15.0	12.5	566.43	583.56	283.22	291.78	533.98	549.18	266.99	274.59
		10.0	8.0	708.80	722.31	354.40	361.15	658.70	670.36	329.35	335.18
		7.5	6.0	833.24	827.62	416.62	413.81	764.87	760.13	382.43	380.06
		5.0	5.0	945.30	888.53	472.65	444.26	858.26	811.20	429.13	405.60
		3.0	3.0	1103.30	1041.18	551.65	520.59	986.52	936.56	493.26	468.28
		1.0	1.0	2298.56	1613.41	1149.28	806.71	1843.85	1375.34	921.93	687.67
	Normal	30.0	25.0	186.94	185.67	93.47	92.84	183.26	182.04	91.63	91.02
		15.0	12.5	283.99	292.00	142.00	146.00	275.60	283.13	137.80	141.57
		10.0	8.0	355.07	362.73	177.54	181.36	342.04	349.14	171.02	174.57
		7.5	6.0	418.32	413.04	209.16	206.52	400.36	395.51	200.18	197.76
		5.0	5.0	474.46	443.84	237.23	221.92	451.47	423.67	225.74	211.83
		3.0	3.0	547.66	518.94	273.83	259.47	517.27	491.57	258.63	245.79
		1.0	1.0	1362.27	1314.44	681.14	657.22	1188.56	1151.98	594.28	575.99
	High	30.0	25.0	88.92	88.92	44.46	44.46	88.08	88.08	44.04	44.04
		15.0	12.5	142.09	145.70	71.05	72.85	139.96	143.46	69.98	71.73
		10.0	8.0	177.94	181.45	88.97	90.72	174.61	177.98	87.30	88.99
		7.5	6.0	209.23	206.71	104.61	103.36	204.63	202.23	102.32	101.11
		5.0	5.0	236.99	222.32	118.49	111.16	231.11	217.14	115.56	108.57
		3.0	3.0	274.73	259.08	137.36	129.54	266.86	252.07	133.43	126.04
		1.0	1.0	708.20	738.68	354.10	369.34	658.19	684.44	329.10	342.22
Highest	30.0	25.0	59.24	59.34	29.62	29.67	58.86	58.96	29.43	29.48	
	15.0	12.5	94.87	97.11	47.43	48.56	93.91	96.11	46.96	48.06	
	10.0	8.0	118.54	121.10	59.27	60.55	117.05	119.54	58.52	59.77	
	7.5	6.0	139.46	137.97	69.73	68.99	137.40	135.96	68.70	67.98	
	5.0	5.0	158.12	148.19	79.06	74.10	155.49	145.87	77.74	72.94	
	3.0	3.0	183.98	174.52	91.99	87.26	180.42	171.31	90.21	85.65	
	1.0	1.0	474.29	493.68	237.14	246.84	451.32	468.85	225.66	234.42	

Resolution (NTSC/PAL)	Quality	FPS		Recording Time (Hr)							
				Video (NTSC/PAL)				Video + Audio (NTSC/PAL)			
		NTSC	PAL	(8 CH, Video) NTSC/PAL		(16 CH, Video) NTSC/PAL		(8 CH, Video+Audio) NTSC/PAL		(16 CH, Video+Audio) NTSC/PAL	
704x240 /704x288	Lowest	30.0	25.0	357.94	356.09	178.97	178.05	344.70	342.99	172.35	171.49
		15.0	12.5	564.38	583.56	282.19	291.78	532.15	549.18	266.08	274.59
		10.0	8.0	705.04	725.91	352.52	362.95	655.46	673.46	327.73	336.73
		7.5	6.0	834.81	826.30	417.41	413.15	766.19	759.01	383.09	379.51
		5.0	5.0	945.30	888.95	472.65	444.48	858.26	811.55	429.13	405.78
		3.0	3.0	1089.37	1034.94	544.69	517.47	975.37	931.51	487.69	465.75
		1.0	1.0	1544.69	1127.59	772.35	563.80	1325.09	1005.90	662.54	502.95
	Low	30.0	25.0	186.60	185.39	93.30	92.70	182.94	181.78	91.47	90.89
		15.0	12.5	285.04	291.23	142.52	145.62	276.58	282.41	138.29	141.21
		10.0	8.0	355.34	362.05	177.67	181.03	342.29	348.51	171.15	174.26
		7.5	6.0	418.19	412.16	209.10	206.08	400.24	394.71	200.12	197.35
		5.0	5.0	474.33	443.10	237.17	221.55	451.36	422.99	225.68	211.50
		3.0	3.0	542.03	522.78	271.01	261.39	512.24	495.02	256.12	247.51
		1.0	1.0	1259.21	1097.45	629.61	548.73	1109.34	981.85	554.67	490.92
	Normal	30.0	25.0	88.97	89.13	44.49	44.56	88.13	88.28	44.07	44.14
		15.0	12.5	142.19	146.06	71.10	73.03	140.06	143.80	70.03	71.90
		10.0	8.0	177.81	181.45	88.90	90.72	174.48	177.98	87.24	88.99
		7.5	6.0	209.26	206.74	104.63	103.37	204.67	202.25	102.33	101.13
		5.0	5.0	237.05	222.26	118.52	111.13	231.17	217.09	115.58	108.54
		3.0	3.0	274.51	261.13	137.25	130.56	266.66	254.01	133.33	127.01
		1.0	1.0	714.45	719.80	357.22	359.90	663.58	668.20	331.79	334.10
	High	30.0	25.0	59.25	59.24	29.62	29.62	58.87	58.87	29.44	29.44
		15.0	12.5	94.78	97.13	47.39	48.56	93.83	96.13	46.91	48.06
		10.0	8.0	118.40	120.95	59.20	60.47	116.92	119.40	58.46	59.70
		7.5	6.0	139.50	137.68	69.75	68.84	137.44	135.68	68.72	67.84
		5.0	5.0	158.23	148.02	79.12	74.01	155.59	145.70	77.80	72.85
		3.0	3.0	182.60	175.31	91.30	87.66	179.09	172.08	89.54	86.04
		1.0	1.0	488.71	499.10	244.35	249.55	464.36	473.73	232.18	236.87
Highest	30.0	25.0	44.47	44.48	22.24	22.24	44.26	44.27	22.13	22.14	
	15.0	12.5	71.17	72.90	35.58	36.45	70.63	72.34	35.31	36.17	
	10.0	8.0	89.00	90.65	44.50	45.33	88.16	89.78	44.08	44.89	
	7.5	6.0	104.64	103.47	52.32	51.73	103.48	102.33	51.74	51.17	
	5.0	5.0	118.61	111.19	59.31	55.59	117.12	109.87	58.56	54.94	
	3.0	3.0	136.27	131.59	68.13	65.80	134.30	129.76	67.15	64.88	
	1.0	1.0	377.19	379.99	188.59	189.99	362.52	365.10	181.26	182.55	

Resolution (NTSC/PAL)	Quality	FPS		Recording Time (Hr)							
				Video (NTSC/PAL)				Video + Audio (NTSC/PAL)			
		NTSC	PAL	(8 CH, Video) NTSC/PAL		(16 CH, Video) NTSC/PAL		(8 CH, Video+Audio) NTSC/PAL		(16 CH, Video+Audio) NTSC/PAL	
704x480 /704x576	Lowest	30.0	25.0	240.47	237.62	120.24	118.81	234.42	231.71	117.21	115.86
		15.0	12.5	379.82	388.56	189.91	194.28	364.94	373.01	182.47	186.50
		10.0	8.0	474.58	483.24	237.29	241.62	451.58	459.42	225.79	229.71
		7.5	6.0	557.12	550.67	278.56	275.34	525.70	519.95	262.85	259.98
		5.0	5.0	632.77	592.35	316.38	296.18	592.54	556.96	296.27	278.48
		3.0	3.0	731.21	674.24	365.60	337.12	678.02	628.76	339.01	314.38
		1.0	1.0	1029.45	746.13	514.73	373.07	927.06	690.83	463.53	345.41
	Low	30.0	25.0	103.43	104.35	51.71	52.17	102.29	103.19	51.15	51.60
		15.0	12.5	162.75	166.54	81.37	83.27	159.96	163.61	79.98	81.81
		10.0	8.0	203.20	207.09	101.60	103.54	198.86	202.59	99.43	101.29
		7.5	6.0	239.18	236.34	119.59	118.17	233.20	230.49	116.60	115.25
		5.0	5.0	272.02	254.18	136.01	127.09	264.30	247.43	132.15	123.71
		3.0	3.0	311.62	298.45	155.81	149.23	301.54	289.19	150.77	144.60
		1.0	1.0	784.77	691.91	392.38	345.95	723.82	644.09	361.91	322.05
	Normal	30.0	25.0	59.27	59.94	29.63	29.97	58.89	59.56	29.45	29.78
		15.0	12.5	94.78	98.58	47.39	49.29	93.83	97.55	46.91	48.77
		10.0	8.0	118.54	121.58	59.27	60.79	117.05	120.01	58.52	60.01
		7.5	6.0	139.56	137.75	69.78	68.88	137.50	135.75	68.75	67.87
		5.0	5.0	158.42	148.04	79.21	74.02	155.77	145.73	77.89	72.86
		3.0	3.0	183.02	174.31	91.51	87.15	179.49	171.11	89.75	85.55
		1.0	1.0	493.00	491.99	246.50	245.99	468.23	467.32	234.12	233.66
	High	30.0	25.0	44.44	44.43	22.22	22.22	44.23	44.22	22.12	22.11
		15.0	12.5	71.03	72.84	35.52	36.42	70.49	72.28	35.25	36.14
		10.0	8.0	88.87	90.68	44.43	45.34	88.03	89.81	44.02	44.90
		7.5	6.0	104.61	103.34	52.30	51.67	103.44	102.20	51.72	51.10
		5.0	5.0	118.54	111.27	59.27	55.63	117.05	109.95	58.52	54.98
		3.0	3.0	136.54	130.73	68.27	65.37	134.57	128.93	67.29	64.46
		1.0	1.0	377.62	379.92	188.81	189.96	362.91	365.04	181.46	182.52
Highest	30.0	25.0	35.54	35.55	17.77	17.78	35.41	35.42	17.70	17.71	
	15.0	12.5	56.89	58.26	28.45	29.13	56.55	57.90	28.27	28.95	
	10.0	8.0	71.11	72.66	35.55	36.33	70.57	72.10	35.28	36.05	
	7.5	6.0	83.76	82.69	41.88	41.34	83.01	81.96	41.51	40.98	
	5.0	5.0	94.81	88.88	47.41	44.44	93.86	88.04	46.93	44.02	
	3.0	3.0	109.26	104.60	54.63	52.30	107.99	103.44	53.99	51.72	
	1.0	1.0	302.82	304.11	151.41	152.06	293.29	294.50	146.64	147.25	

 **NOTE**

This recording time table is for reference only.
The recording time can be different depending on your surveillance environment.

Specifications

Model			LRD5160 Series	LRD5080 Series
Video	Input	Analog	16	8
	Output	Loop Through	16	8
		(Main) VGA	1	1
		(Main) HDMI	1	1
		(Spot) Composite	1	1
Audio	Input		4	2
	Output		2	2
Alarm	Input		16	8
	Output		4	2
	Notification	Buzzer	Support	Support
		e-mail	Support	Support
		Remote S/W (Client S/W, VMS)	Support	Support
Emergency S/W		Support	Support	
Recording (Analog)	Frame Rate (/Second)	NTSC	Up to 480 IPS @ 352x240 Up to 240 IPS @ 704x240 Up to 120 IPS @ 704x480	Up to 240 IPS @ 352x240 Up to 120 IPS @ 704x240 Up to 60 IPS @ 704x480
		PAL	Up to 400 IPS @ 352x288 Up to 200 IPS @ 704x288 Up to 100 IPS @ 704x576	Up to 200 IPS @ 352x288 Up to 100 IPS @ 704x288 Up to 50 IPS @ 704x576
Search	Playback Speed	FF/ Reverse	4 Steps (1x - 16x)	
		Frame Advance	Forward / Backward	
	Screen Division		Full, 4, 9, 16	Full, 4, 9
	Search Mode		Date/Time, Event, Export, Protect, Bookmark, ATM/POS, Smart	
Display	Frame Rate (/Second)	NTSC	480 IPS (Real time per channel)	240 IPS (Real time per channel)
		PAL	400 IPS (Real time per channel)	200 IPS (Real time per channel)
	Division Mode		Full, 4, 9, 16, 1+5, 1+7	Full, 4, 9, 1+5, 1+7
Storage	Internal HDD	Max Capacity	8 TB (Up to 4 HDDs)	
	External HDD	Interface Type	E-SATA	
Backup	Backup Interface		USB 2.0 (x3), Network, e-SATA	
Serial I/F	PTZ Control Interface		RS-485 (x2)	
Network	Network Connection		Ethernet 10/100/1000 Mbps	
	Network Transmission		Up to 240 IPS	
	Bandwidth Control		Yes	
Power			AC Free 100~240V, 50/60 Hz	

Power Consumption	Maximum 80 W (with 4 HDD)	
Dimension (W x D x H)	430 mm x 430.5 mm x 96 mm	
Net Weight (without HDD)	6.14 kg	6.06 kg
Net Weight (with 4 HDD)	8.6 kg	8.52 kg
Operating Temp. / Humidity	0 °C to 40 °C / 0 % RH to 80 % RH	

**NOTE**

Design and specifications are subject to change without notice.



The terms HDMI and HDMI High-Definition Multimedia Interface, and the HDMI logo are trademarks or registered trademarks of HDMI Licensing LLC in the United States and other countries.

