



# OWNER'S MANUAL

# CLEANING ROBOT

Before using, please carefully read the Safety Precautions pages to allow for safe operation of the product. After reading the operation manual, please keep it in an easily accessible location.

VR634\* ser.

VR635\* ser.



MFL68042510

[www.lg.com](http://www.lg.com)

# FEATURES

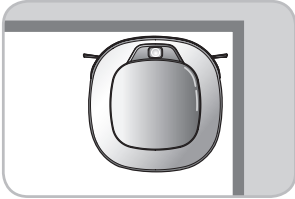

## Corner Master

By having adopted a brand new concept design that is appropriate for walls, the Robot Cleaner's cleaning performance is incredibly efficient.

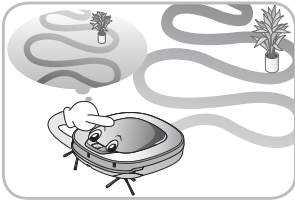

## Learning Mode

The Robot Cleaner is capable of memorizing the cleaning environment via its Smart Operation feature for smarter cleaning.

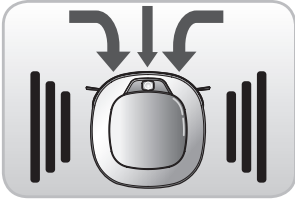

## Turbo Mode

In the "Turbo" mode, the Robot Cleaner runs more powerful giving cleaner results.

When selected, the "Turbo" mode is automatically activated on carpets, which enables the Robot Cleaner to run more efficiently.

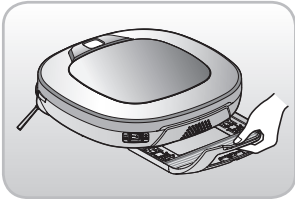

## Drawer Mop Plate (option)

The "Drawer mop plate" makes it much easier for users to change the mop without having to flip the device over.

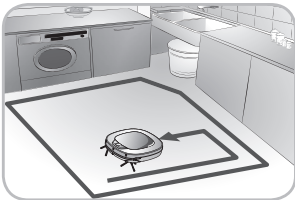

## My Space Mode

By commanding it to clean a particular space, the Robot Cleaner quickly cleans the desired space.

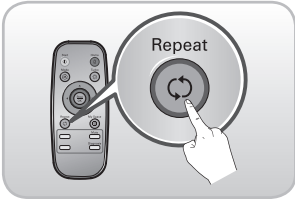

## Repeat Cleaning

The Robot Cleaner will continuously clean until the battery runs out.

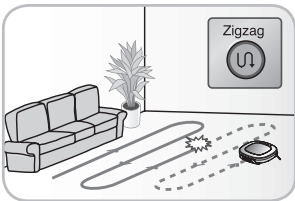

## Location Search Function

When the Robot Cleaner is moved from a spot while operating, the device will automatically search for the previous location and return to the spot from where it was interrupted.

# CONTENTS

## 1

### BEFORE USING

---

- 2~5 Safety precautions
- 6 Included with product
- 7~8 Parts description
- 9~10 Button functions
- 11 Display status information
- 12 Before you start
- 13 Overview

## 2

### METHOD OF USE

---

- 14 How to install the home station
- 15 How to turn the Robot Cleaner power supply on & off
- 16 How to start and stop cleaning
- 17 How to charge the battery
- 18~19 Cleaning modes
- 20 Auxiliary cleaning modes
- 21 Mop cleaning (option)
- 22 Location search function
- 23~24 Smart diagnosis

## 3

### HANDLING METHOD AFTER USE

---

- 25 Cleaning the dust bin
- 26 Cleaning the dust bin filter
- 27 Cleaning the brush
- 28 Cleaning the sensor/charging terminal
- 29 Cleaning the side brush
- 30 Cleaning the ultra microfiber mop (option)

## 4

### ADDITIONAL INFORMATION

---

- 31~33 Troubleshooting
- 34 Before you call for service

## 5

### REFERENCE

---

- 35 Product specifications
- 36 Reference items

# SAFETY PRECAUTIONS

The purpose of the safety precautions described below is for the user to use the product safely and correctly to prevent any unexpected risk of injury or damage.

## Basic safety precautions

After reading this manual, please keep it in an easily accessible location.



This is the safety alert symbol. This symbol alerts you to potential hazards that can result in property damage and/or serious bodily harm or death.



**WARNING** Indicates a hazardous situation which, if not avoided, could result in death or serious injury.



**CAUTION** Indicates a hazardous situation which, if not avoided, could result in minor or moderate injury.



## WARNING

1. This appliance is not intended for use by persons (including children) with reduced physical, sensory or mental capabilities, or lack of experience and knowledge, unless they have been given supervision or instruction concerning use of the appliance by a person responsible for their safety.
2. Children should be supervised to ensure that they do not play with the appliance.
3. If the supply cord is damaged, it must be replaced by LG Electronics Service Agent in order to avoid a hazard
4. This appliance can be used by children aged from 8 years and above and persons with reduced physical, sensory or mental capabilities or lack of experience and knowledge if they have been given supervision or instruction concerning use of the appliance in a safe way and understand the hazards involved. Children shall not play with the appliance. Cleaning and user maintenance must not be made by children without supervision.

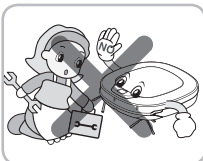

For your safety, do not remove the battery from the Robot Cleaner. If you need to replace the battery or the Robot Cleaner, take it to the nearest authorized LG Electronics service center or dealer for assistance.

Failure to follow this warning can cause fire or product failure.

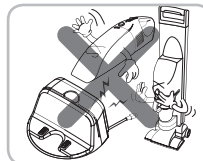

Never use the Robot Cleaner with a battery and/or home station from any other product than the Robot Cleaner.

Doing so can cause fire or product failure.

# SAFETY PRECAUTIONS

## WARNING

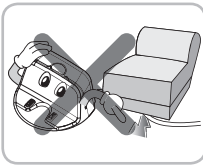

Make sure the power cord of the home station is not crushed under a heavy object or damaged by contact with sharp objects.

Failure to follow this warning can cause electric shock, fire or product failure. If the power cord is broken, do not plug it in. Take the product to an LG Electronics Authorised service repairer.

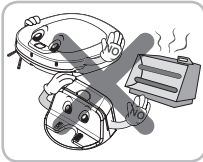

Do not place the home station and the Robot Cleaner near a heating device.

Doing so can cause product deformation, fire, or product failure.

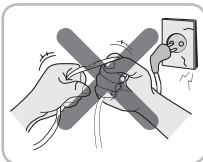

Do not force the power plug to bend. Do not use the power plug when it has been damaged or loosened.

Doing so can cause fire or product failure.



Do not touch the power plug with wet hands.

Doing so can cause electric shock.

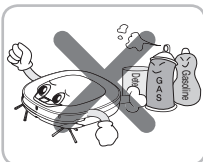

Do not spray or use inflammable materials, surfactants, or drinking water in the vicinity of the Robot Cleaner.

Doing so can cause fire or product failure.

\* Inflammable materials: gasoline, thinner, etc.  
\* Surfactant: detergent, articles for bath, etc.



Do not insert any part of the body, such as a hand or foot, below the brush or wheels of the Robot Cleaner while in use.

Doing so can cause injury or product damage.



Do not operate the Robot Cleaner on narrow and high furniture such as a wardrobe, refrigerator, desk, table, etc.

Doing so can cause injury, product failure or damage which is not covered by the warranty.

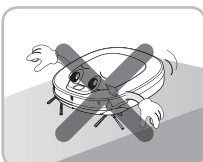

Do not activate the device on a floor that has more than a 10 degree incline.

The device may not work properly.

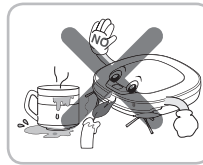

Do not use the Robot Cleaner when candles or fragile objects are placed on the floor.

Doing so can cause fire or product failure.

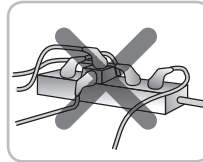

Always use a dedicated power outlet with a 10 amp rating.

If multiple appliances are connected to an outlet simultaneously, they can generate enough heat to cause a fire.

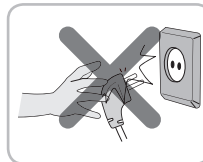

When pulling out the home station power plug, always pull it out by grabbing the plug, not the cord. When pulling out the power plug, do not to touch the prongs with your fingers.

Doing so can cause an electric shock.

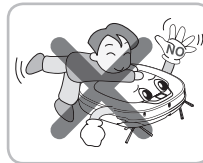

Do not allow children or pets to play with or rest upon the Robot Cleaner at any time. Do not use the Robot Cleaner while an object is hanging from it.

Doing so can cause injury or product damage.



Turn the power supply off immediately if any abnormal sound, odor, or smoke is generated from the Robot Cleaner by removing it from the home station and turning off the main switch on the rear side of the unit.

Failure to do so can cause fire or product failure.

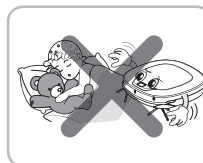

Do not operate the Robot Cleaner in a room where a child is sleeping.

Doing so can cause injury or product damage.

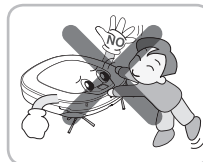

Do not leave Children or pets near the Robot Cleaner unsupervised.

Doing so can cause injury or product damage.

 This product is intended for indoor domestic home use and should not be used in mobile applications. It should not be used in commercial applications such as workshops or garage, etc.

# SAFETY PRECAUTIONS

## ! CAUTION

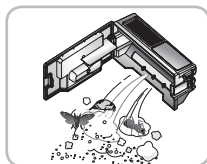

Frequently empty the dust bin and maintain its cleanliness.

The dust collected in the dust bin can trigger allergies and may contain harmful insects.



Do not drop the Robot Cleaner or subject it to strong impacts.

Doing so can cause injury or product failure not covered by the warranty.

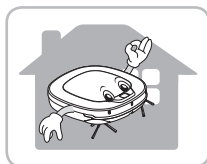

Use the Robot Cleaner indoors only.

Using it outdoors can cause product failure and irreparable damage to the unit.

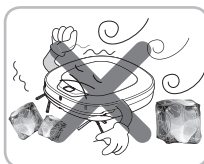

Do not expose the Robot Cleaner to cold temperatures (less than  $-5^{\circ}\text{C}$ ) for a long period of time.

Doing so can cause product failure.

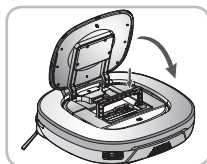

Close the cover of the dust bin on the main unit before starting cleaning.

If the cover is not closed, it can cause injury or product damage.

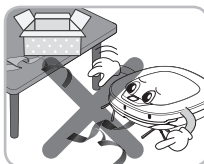

Remove any cables or string from the floor before starting.

Cable or string can get tangled in the wheels of Robot Cleaner and cause product failure or the cord of an appliance can be disconnected.

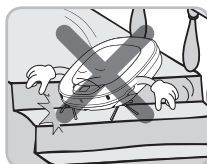

DO NOT use the Robot Cleaner around a banister, staircase or any other dangerous place.

Otherwise, the user or the product can be exposed to damage.

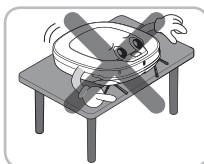

Make sure the Robot Cleaner is not put on a table or desk, with the power ON.

It may result in injury of the user or damage in the product.

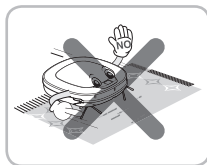

In rare cases, the Robot Cleaner's brush can damage the carpet. If this happens, immediately stop the cleaning operation.

When a carpet has long tassels, the tassels can be damaged.

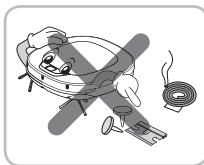

Do not allow the Robot Cleaner to sweep up liquids, blades, thumb tacks, kindling, etc.

These items can cause product failure.

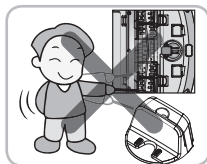

Do not let the main unit and charging terminal of the home station come into contact with metallic objects.

Doing so can cause product failure.

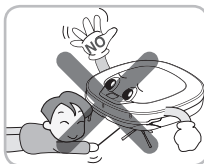

Do not put sharp objects into the opening of the Robot Cleaner's ultrasonic sensor.

Doing so can cause product failure.

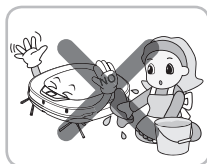

Do not put water, detergent, etc. into the Robot Cleaner.

Doing so can cause product failure. Do not put any water or detergent on the Robot Cleaner. If liquids get inside of the Robot Cleaner, turn off the power supply and contact an LG Electronics sales agent or customer care center.

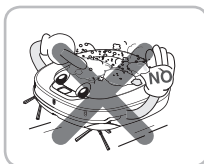

Do not use the Robot Cleaner when the dust bin is completely filled up.

Doing so can cause product failure.

# SAFETY PRECAUTIONS

## CAUTION



If the floor is wet or has wet spots, wipe them up before using the Robot Cleaner. Do not use the Robot Cleaner on a wet surface.

Failure to do so can cause product failure.

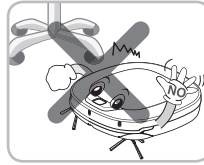

When the robot cleaner is operating, it may hit the chair leg, desk leg, table leg or other narrow pieces of furniture.

For quicker and better cleaning, place the dining chairs on top of the dining table.

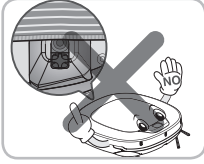

When attaching the mop, do not block the bottom camera sensor.

Blocking the bottom camera sensor may not allow the product to work smoothly. (Some models may not have the sensor.)

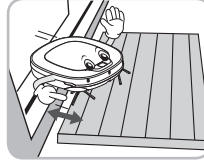

Make sure the plate on the floor is higher than 2 cm from the ground before starting the cleaning.

If the threshold is low, the Robot Cleaner can go over it and perhaps into an undesirable location. Make sure that all the doors of the rooms that are not to be cleaned are closed.

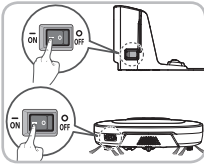

If you do not use it to save the energy, turn off the power switch, and turn on the power switch when you are cleaning or recharging it.



## Tip

Check the following items before use:

- Empty the dust bin after each operation or prior to it filling up.
- Remove any cables or long strings from the floor.
- Remove any moisture from the floor before cleaning.
- Close the cover of the dust bin before cleaning.
- Remove fragile or unnecessary objects from the room to be cleaned. For example, remove expensive ceramics and valuables from the floor.
- Confirm whether the battery has sufficient power, and if it is low, recharge it.
- Close the doors of any room that you do not want the Robot Cleaner to enter. During cleaning, the Robot Cleaner may enter another room and continue cleaning.
- Do not use this product in the room where a child is sleeping alone. The child can be hurt or woken.
- Remove towels, foot towel or any other thin cloth from the floor as they can get caught by the brush.
- Before starting the device, it's better to remove carpets that are thicker than 20 mm as they may cause it to malfunction.
- Please close any balcony doors. The wheels may get stuck while cleaning.

# INCLUDED WITH PRODUCT

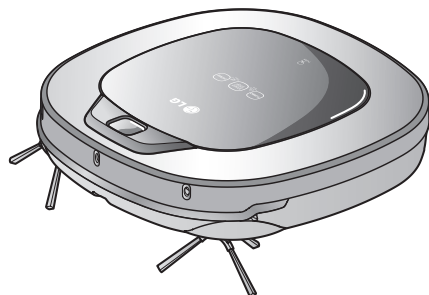

Robot Cleaner



Remote controller

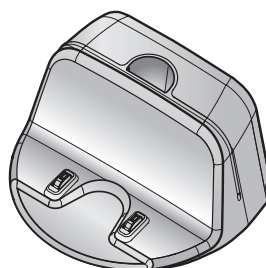

Home station

► Figures can be different from actual objects.

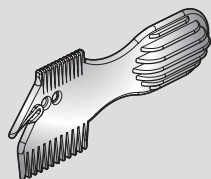

Cleaning Tool

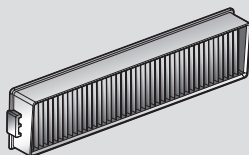

Dust bin filter (spare)  
(option)

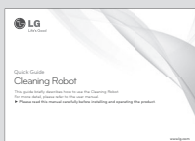

Quick guide



Operation manual

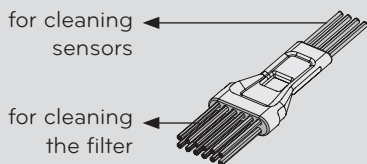

Cleaning brush  
(It's on the dust bin cover)

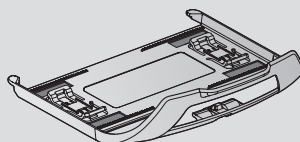

Mop plate (option)

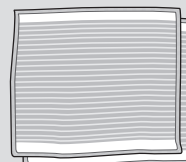

Ultra microfiber mop  
(2 pieces) (option)

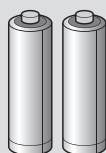

Dry cell for remote controller  
(2 units of AAA size)

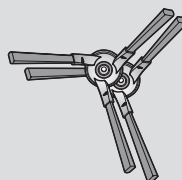

Side brush (2 pieces)  
(option)

# PARTS DESCRIPTION - ROBOT CLEANER

## Plan view

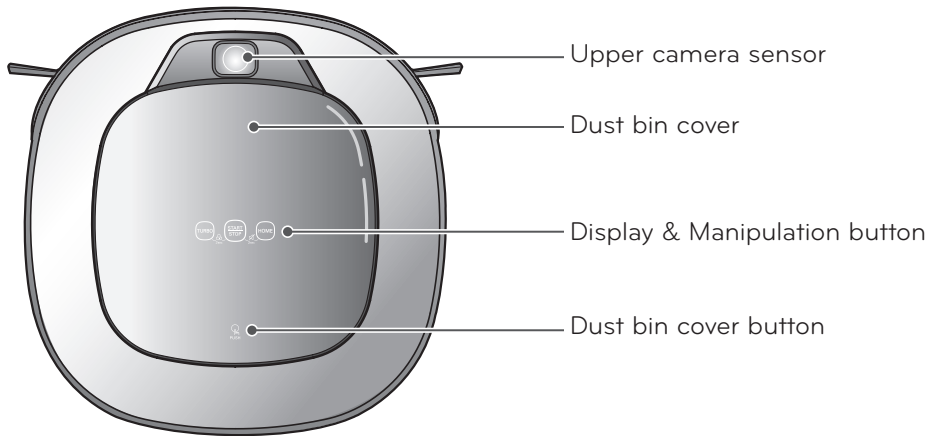

## Front view

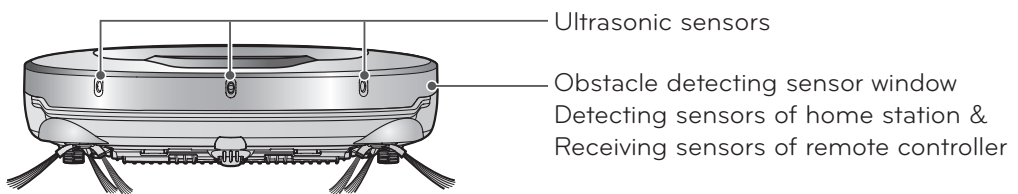

## Rear view

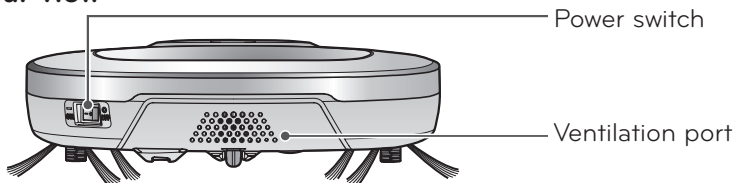

## Bottom view

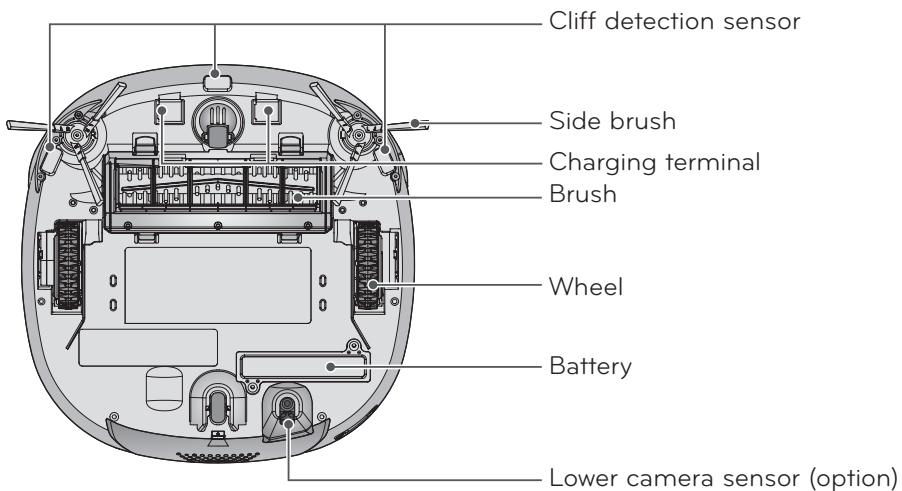

► Figures can be different from actual objects.

# PART DESCRIPTION – HOME STATION / DUST BIN

## Home station

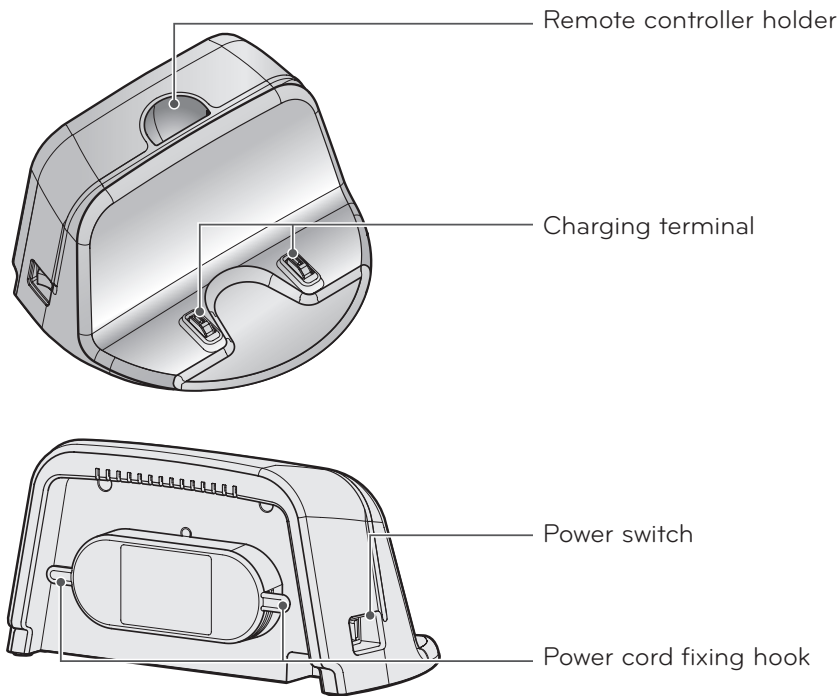

## Dust bin

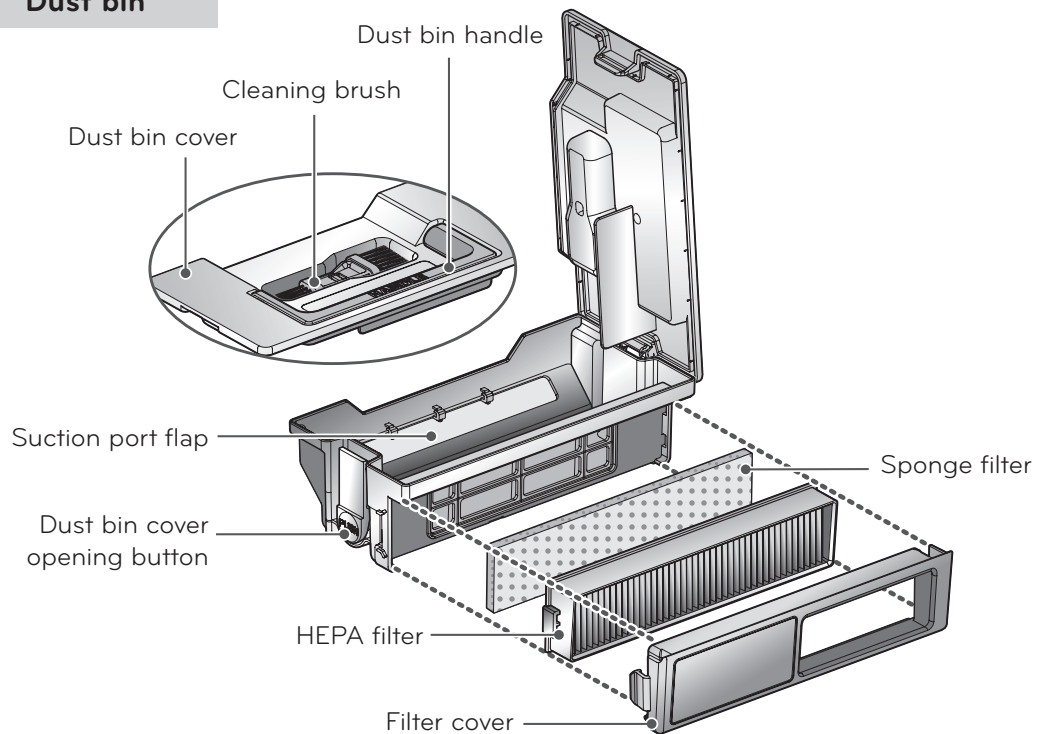

► Figures can be different from actual objects.

# BUTTON FUNCTIONS – ROBOT CLEANER

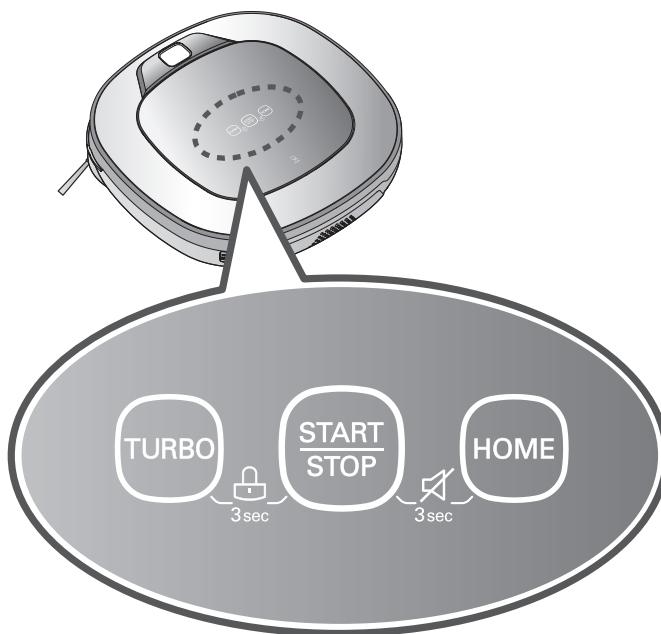

## TURBO

- If the button is pressed, 'Turbo Mode' will be set with a voice confirmation.
- If the button is pressed whilst in 'Turbo Mode', it will be canceled.

## START/STOP

- Used to turn the power ON, start or stop cleaning.
- If the button is pressed whilst the unit is powered ON, it will start cleaning.
- If button is pressed during the cleaning, it will stop the cleaning.
- If the button is pressed for about 2 sec. whilst the power is ON, the power will be OFF.
- If the button is pressed in 'Smart Diagnosis' mode, it will end the diagnosis.

## HOME

- Used to return the Robot Cleaner back to the home station for charging.
- If cleaning is finished or the battery is low, the Robot Cleaner will return to the Home Station by itself to recharge its battery.

## BUTTON LOCK On/Off

- Pressing the 'Turbo' and 'START/STOP' button for 3 seconds will activate or deactivate the Lock function.
- If 'Lock' is ON, a voice announcement "Key has been locked" will be heard each time a button is pressed.

## Voice Alert On / Off

- Press and hold both the Start and Charge button on the main unit for 3 sec. to turn ON/OFF the Voice Alert.
- If the Voice Alert is OFF, the Mute lamp is ON.
- You cannot use this feature with the buttons on the remote control.

# BUTTON FUNCTIONS – REMOTE CONTROLLER

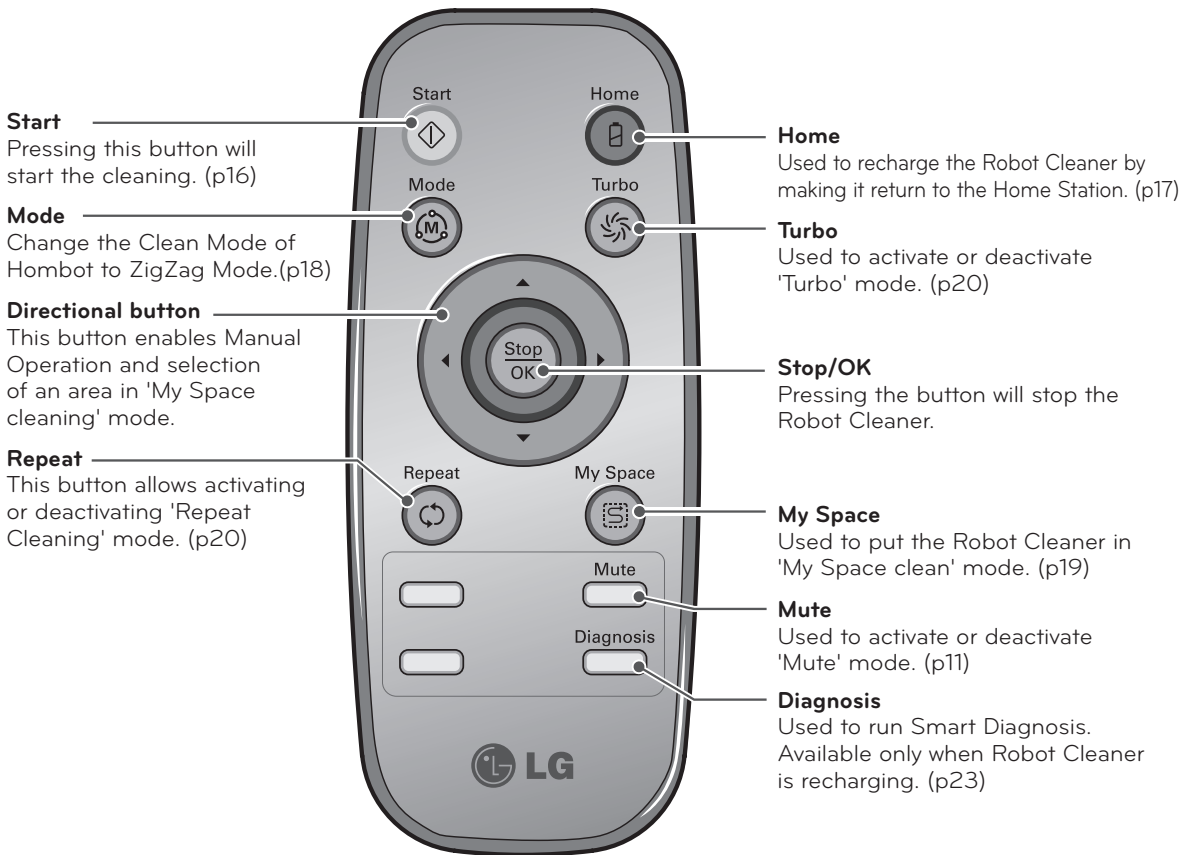

## Tip

- Remote Controller does NOT provide a Power ON function.
- With the machine's power OFF, the Remote Controller will not work.
- To turn the power ON/OFF, use the 'Start/Stop' button on the upper section of the Robot Cleaner.
- Only use the 'Mode', 'My Space' button after stopping Robot Cleaner.

# DISPLAY STATUS INFORMATION

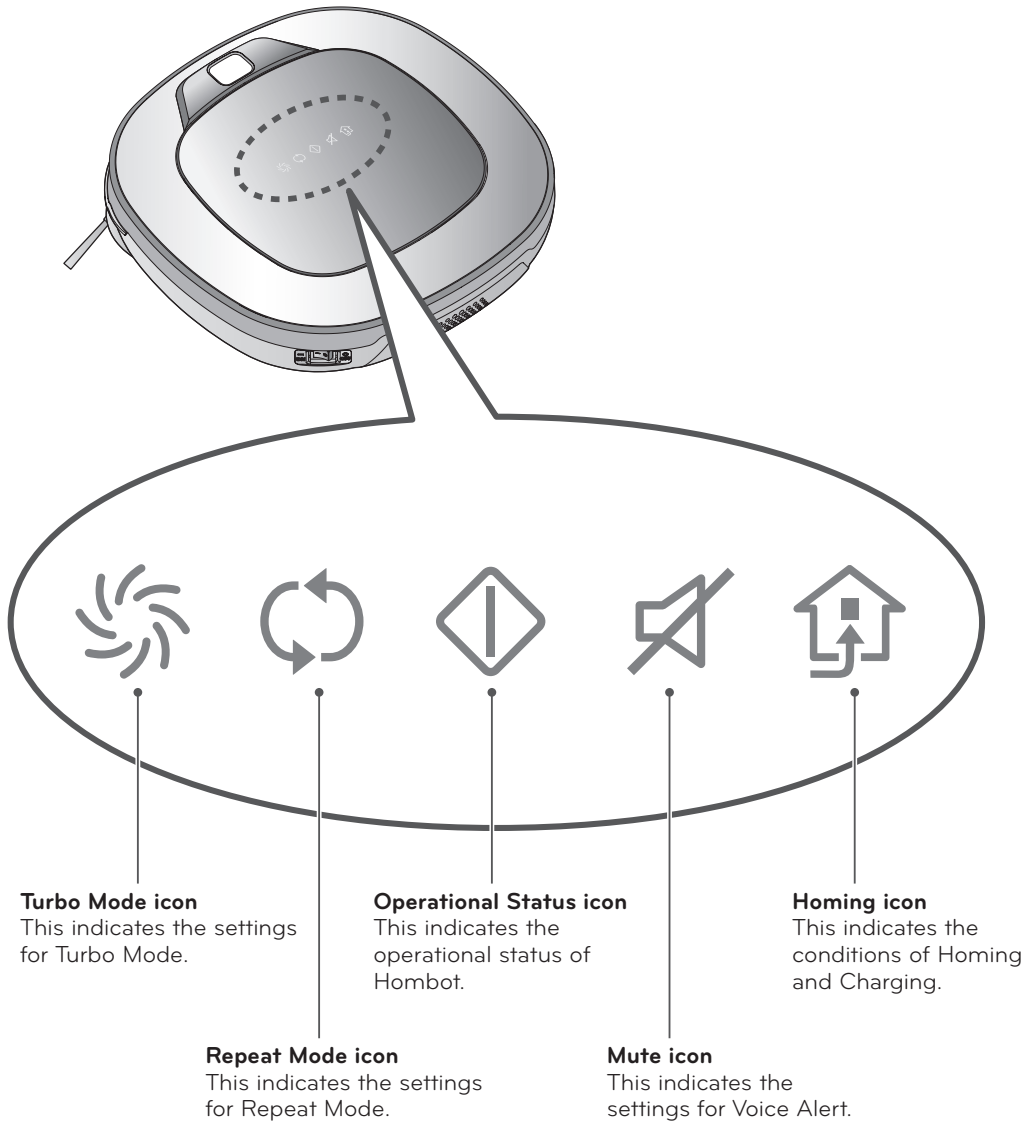

# BEFORE YOU START

## Check these items before cleaning

- Do not use this device in a room where a child is left alone. The child could be injured.
- Remove fragile or unnecessary objects from the room to be cleaned. Especially, remove expensive ceramics and valuables from the floor.
- Close the cover of the dust bin before cleaning.
- Remove any moisture that might be on the floor.
- Remove cables, strips, towels, mats etc. from the floor so they will not get caught by the brush.
- Confirm whether the battery charge is sufficient, and if it is low, recharge it.
- Empty the dust bin before or after each clean, or before it becomes full.
- Close the doors of any room that you do not want the Robot Cleaner to enter. During cleaning, the Robot Cleaner may enter another room and continue cleaning.
- When the mop is attached, Robot Cleaner will not be able to go over thresholds of 5 mm or higher. If you are not planning to use the mop for cleaning, separate the mop before using Robot Cleaner.
- Before starting the device, it's better to remove carpets that are thicker than 20 mm as they may cause it to malfunction.
- Please close any balcony doors. The wheels may get stuck while cleaning.

## Loading the remote controller battery

1. Open the battery cover by lifting the rear hook of the remote controller.
2. Insert two AAA batteries, checking for +, - nodes while loading.
3. Close the battery cover completely so that the batteries will not fall out.

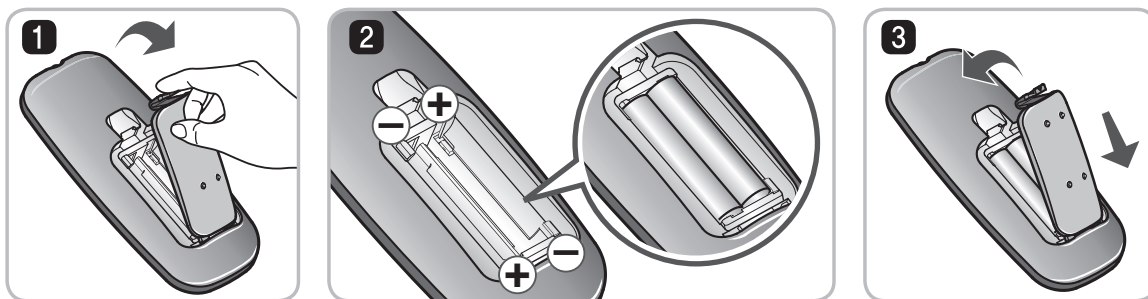

## Precautions while using the remote control

- Only press one button at a time.
- Do not drop or subject it to forceful impact.
- Do not store it near devices that give off heat, fire or hot air.
- Certain fluorescent lamps, such as the three band radiation lamp, can interfere with the activation of the remote control. Therefore, use it as far away as possible from such lamps.
- If the remote control is far from the Robot Cleaner when activated, it may fail to operate properly. Use the device within 3 m of the Robot Cleaner if possible.

1

## Install the home station. (p14)

Insert the power cord plug into an outlet and locate the station against a wall. If power is not supplied to the home station, the Robot Cleaner will not charge.

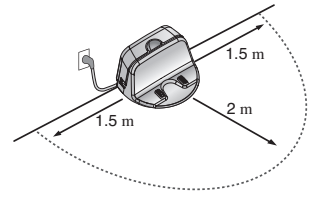

2

## Turn on the power supply of the Robot Cleaner. (p15)

Turn ON the power switch on the rear-left of Robot Cleaner, and press the 'Start/Stop' button on the top.

\* If the power supply is not turned on, refer to page 15.

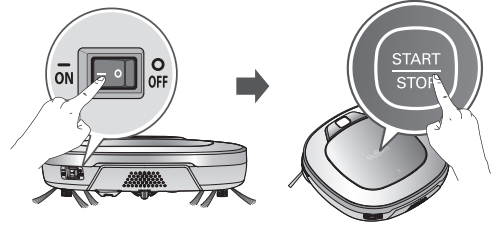

3

## Check the dust bin.

Check the cleanness of the dust bin before start cleaning and close the cover of the dust bin on the main unit.

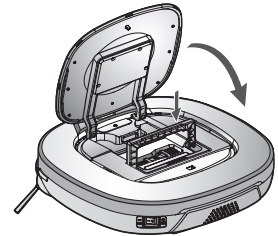

4

## Start cleaning. (p16)

Press the START/STOP button once again while the Robot Cleaner is turned on. You will hear the sound of cleaning and cleaning will begin.

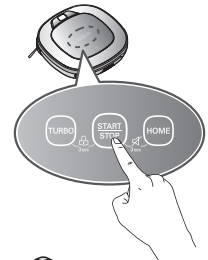

5

## Automatic charge. (p17)

The Robot Cleaner will self-diagnose and automatically return to the home station to recharge before the complete discharge of the battery. It takes approximately three hours to charge the battery.

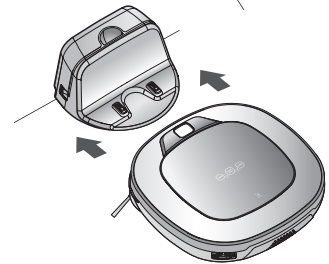

6

## Use the cleaning mode and auxiliary functions. (p18~21)

Use the buttons on Robot cleaner and Remote Controller to use each cleaning mode and supporting feature.

For Cleaning Mode, you can choose among ZigZag, Zone, and Repeat; for secondary features, Manual and Microfibre Mop (option).



< Warning > When Robot Cleaner is operated with the cover of the dust bin open, it can cause an injury or serious damage to the product.

# HOW TO INSTALL THE HOME STATION

## How to Install the Home Station

1. Position the home station against a wall on hard level flooring to prevent sliding during docking.

Remove objects within 1.5 m to the right and left side and within 2 m to the front.

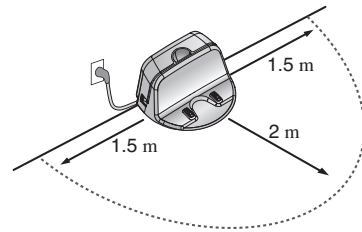
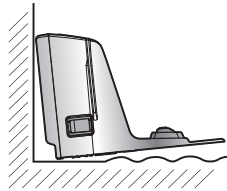
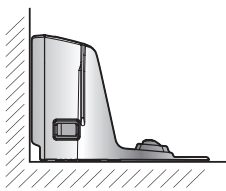

2. Plug the power cord into an outlet.

Wrap the power cord around the fixed hook on the back side of the home station or along the wall surface so that the travel path of the Robot Cleaner will not be obstructed.

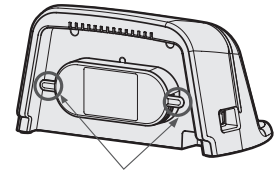

Fixing hook of power cord

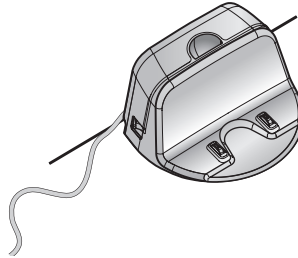
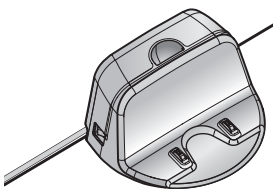

3. Fix the home station against the wall so that it does not move. Please turn on the power switch.

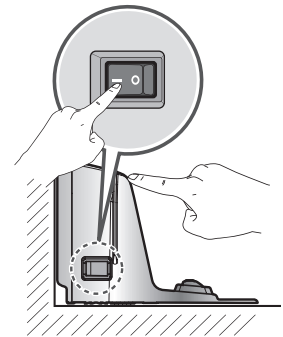

4. When the remote controller is not used, store it on the remote controller holder on the home station.

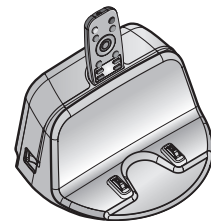

### Tip

- Always keep the home station plugged in. If the home station is not plugged in, the Robot Cleaner will not return to the station to charge automatically.

### < Warning >

**Do not operate the Robot Cleaner if the Home Station has a damaged cord or plug, if it is not working properly, or if it has been damaged or dropped. To avoid hazard, the cord must be replaced by LG Electronics, Inc. or a qualified service person.**

# HOW TO TURN THE ROBOT CLEANER POWER SUPPLY ON & OFF

## Turning on the main power supply

Make sure the Power Switch on the rear-left of the Robot Cleaner.

If the power is OFF, turn the switch ON.

- \* When turning on the power switch, do not press the button located at the upper section of the Robot Cleaner. Operation of the button can be delayed.
- \* Turn off the power switch if the Robot Cleaner will not be used for a long period of time, in order to protect the battery. The Robotic Cleaner cannot charge if the main switch is in the "OFF" position.

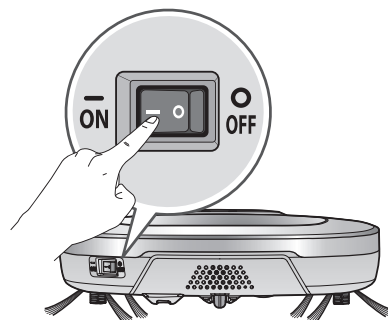

## Turning on from Stand By power.

With the power of Robot Cleaner OFF, press 'Start/Stop' button for 1 second until a "Ting" sound is heard. In about 10 seconds, the power will be on and a melody will sound.

- \* If 10 minutes elapse without the Robot Cleaner having being given an active command after being turned on, the power will automatically turn OFF.



## Turning off the power supply

Press the START/STOP button for two seconds while the Robot Cleaner is turned on. A melody will sound when the power is turned off.



### Tip

- If the power cannot be turned on, do the following.
  - Turn on the power switch and wait for more than 3 seconds.
  - Press the 'START/STOP' button when the power switch is turned on.
  - If the power is not turned on or if there is no display but only the "Ting" sound, put the Robot Cleaner manually on to the home station.

# HOW TO START AND STOP CLEANING

## Using the buttons on the Robot Cleaner

After the Robot Cleaner is turned on, press the START/STOP button to begin cleaning. A melody will sound and cleaning will begin.

Press the START/STOP button during the cleaning cycle to stop cleaning.

- \* When the 'START/STOP' button is pressed while the power supply of the Robot Cleaner is turned off, the power will be turned on. Press the 'START/STOP' button one more time to start cleaning.

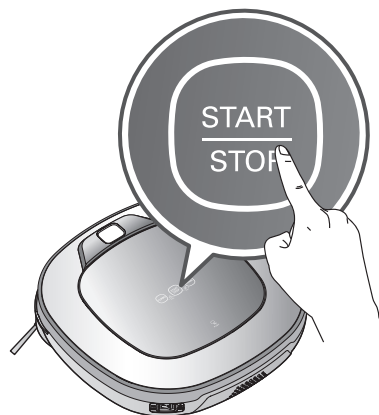

## Using the remote controller

After the Robot Cleaner is turned on from the Robotic Cleaner, press the START button on the remote control. A melody will sound and cleaning will begin.

Press the Stop/OK button during the cleaning cycle to stop cleaning.

- \* The Robot Cleaner cannot be turned on from Stand By, by using the remote controller when the power of the Robot Cleaner is off. When the power is off, press the 'START/STOP' button on the upper side of Robot Cleaner to turn the power on and to allow the remote to be used.



- \* During cleaning, collisions can happen when the sensor cannot detect objects because of their shape (Thin chairs and table legs, furniture corner). When this happens, the internal impact detecting sensor will react by using a backward motion.
- \* If the Robot Cleaner is set to start cleaning at a location away from the home station, put the Robot Cleaner on a flat floor in order to prevent a malfunction of the obstacle detecting sensor. In addition, start cleaning from a location where there are no obstacles such as curtains or walls within 30 cm of the Robot Cleaner.



### Tip

For best results:

- Briefly scan the area to be cleaned for big and small objects that will cause difficulty for the Robot Cleaner.
- If cleaning is started when the Robot Cleaner is at the home station, the device can rapidly be returned to the home station as the current home position has been accurately read.
- When the mop plate is installed, to prevent a 2<sup>nd</sup> contamination from the contaminated mop, it will not go over door sills of 5 mm or higher.

# HOW TO CHARGE THE BATTERY

## Automatic charging

The Robot Cleaner returns to the home station at the end of a cleaning cycle or when its battery is running low.

- \* If 10 minutes elapse without the Robot Cleaner moving or the battery is too low, the power will automatically be turned OFF.
- \* **Do NOT turn OFF the Main Power Switch as the battery will not be recharged. If the machine is returned manually with the Main Power Switch OFF, it shows an error message, "Main power switch on the back of the HOM-BOT is turned off. Please turn the switch on."**
- \* In the event that the unit returns to the Home Station due to a low battery during the cleaning, cleaning will be started, after the charging, from the nearest place of the area which has not been cleaned before.
- \* If Robot Cleaner is unable to dock to the home station on its first attempt, it will try again until it docks successfully.
- \* When Robot Cleaner has completed all areas that it can clean, it will return to the home station even when the battery level is not low.

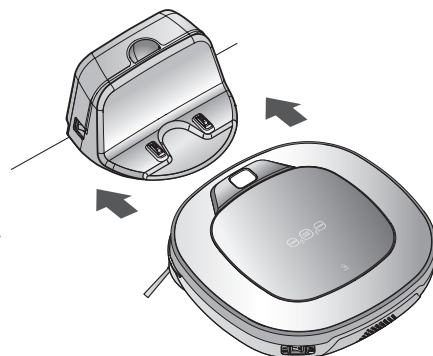

## Manual charging

If using the Robot Cleaner for the first time or when charging the battery during cleaning, you can manually charge the battery.

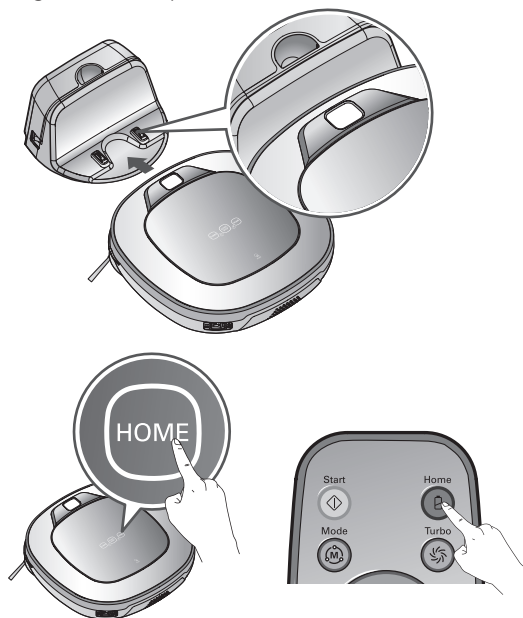

**Method 1.** Attach the Robot Cleaner to the home station by aligning to the front side of the home station. A melody sound will be generated along with an audio message to start charging.

- \* If a voice message, "Main power switch on the back of the HOM-BOT is turned off. Please turn the switch on." is announced repeatedly, then turn on the Main Power Switch.

**Method 2.** When the 'HOME' button of the remote control or the Robot Cleaner is pressed, charging will be prompted by automatically generating a searching signal and returning the Robot Cleaner to the home station.

- \* If the Robot Cleaner did not start cleaning from the home station or if the Robot Cleaner is manually charged by pressing the Home button, it may take slightly longer to find the home station.
- \* If the Robot Cleaner is within 10 cm of the front of the charging terminal while the power supply is turned on, it will automatically be returned to the home station and charging will begin.



### Tip

Take the following precautions when using the home station:

- If foreign material is caught in the charging terminal, charging may not proceed smoothly. Wipe the terminal from time to time with a dry cloth after the power plug is disconnected.(p28)
- To prevent electric shock or damage to the home station, do not touch the charging terminal with any metallic objects.
- To avoid fire or electric shock, never disassemble or modify the home station.
- Do not place the home station or power plug near a heating source.

# CLEANING MODES

## Zigzag Cleaning

In 'Zigzag Clean' mode, Robot Cleaner repeats a zigzag operation to clean every and each spot in the cleaning area.

If you need to quickly clean an area choose 'Zigzag Clean' mode.

Press 'Mode' button on Remote Controller to select 'Zigzag Clean' mode and press 'Start' button.

\* Factory release default setting is 'Zigzag Clean.'

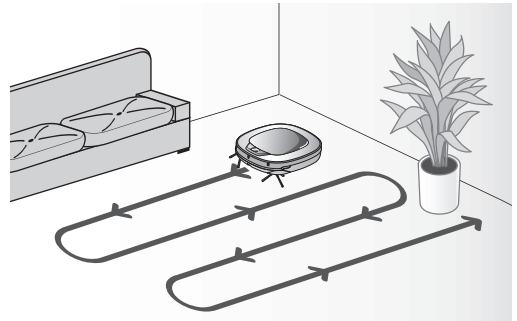
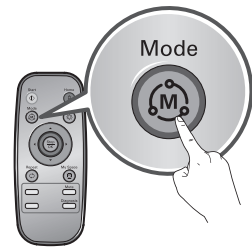

## Manual cleaning

By pressing a direction key on Remote Controller, you can move Robot Cleaner in a Manual mode.

Robot Cleaner will clean the area, moving forward/backward/left/right, according to the input of the direction key.

While in 'Manual' mode, the robot cleaner will run into obstacles placed behind it if the backward key on the remote remains held down.



# CLEANING MODES

## My Space Cleaning

Pressing 'My Space' on Remote Controller will set the My Space cleaning mode with a voice message.

For cleaning of particular spaces, select this mode.

### The 1st stage:

Use the Remote Controller to manually run the cleaning on outskirts of each cleaning block.

- \* This cleaning mode will be accepted when the distance of the start and end position is less than 1 m.

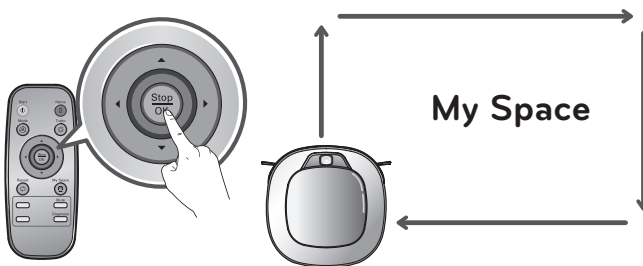

### The 2nd stage:

Pressing the 'Start' button will then make the Robot Cleaner clean the manually outlined area by itself.

- \* Upon failure to correctly outline a zone, a voice will announce, which says "Area does not meet the specified conditions. Please continue to make specified area for cleaning process."  
Use the Remote Controller to assign a zone, again.
- \* If Zone cleaning is complete, the mode is switched to Auto Clean (ZigZag).

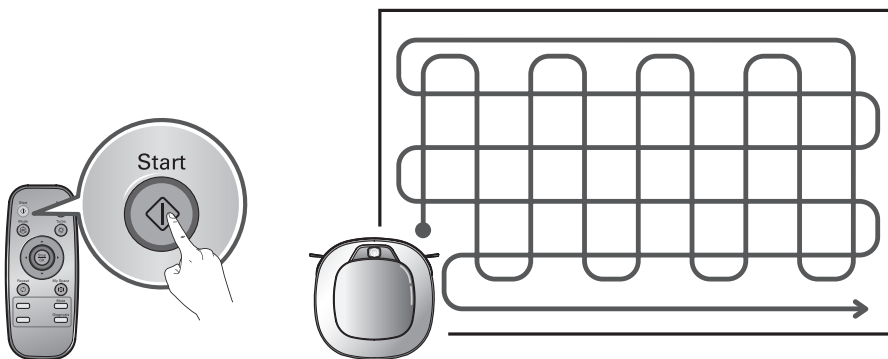

### Tip

- While recharging, you cannot activate 'My Space clean' mode.
- To change the cleaning mode while Robot Cleaner is in operation, press 'Stop/OK' button first to select a mode. The cleaning will start from the beginning.

# AUXILIARY CLEANING MODES

## Turbo Mode

Pressing 'Turbo' button on Remote Controller or main unit will activate 'Turbo' mode, with a voice message.

While in 'Turbo' mode, pressing the same button will cancel 'Turbo' mode, with a voice message.

In 'Turbo' mode, Robot Cleaner runs more intensely for a powerful clean.

### \* <Turbo Mode (Floor Master Function)>

'Turbo mode' will automatically operate when the Robot Cleaner cleans carpets (10 mm ↑).

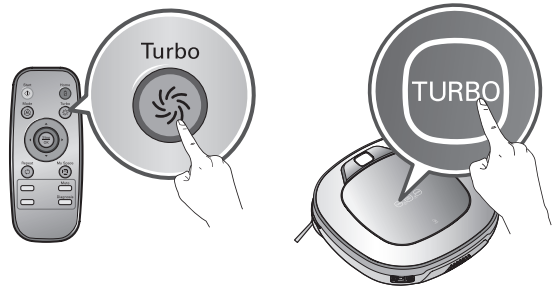

## Repeat Mode

Pressing 'Repeat' button on Remote Controller will activate 'Repeat' mode, with a voice message.

While in 'Repeat' mode, pressing the same button will cancel 'Repeat' mode, with a voice message.

In 'Repeat' mode, Robot Cleaner repeats the cleaning in progress until the battery runs out.

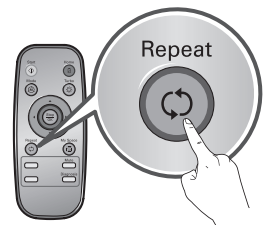

## Learning Mode

Robot Cleaner is capable of memorising the cleaning environment through its Learning mode for an intelligent cleaning operation.

\* 'Learning Mode' is available only when the machine starts cleaning from the Home Station.

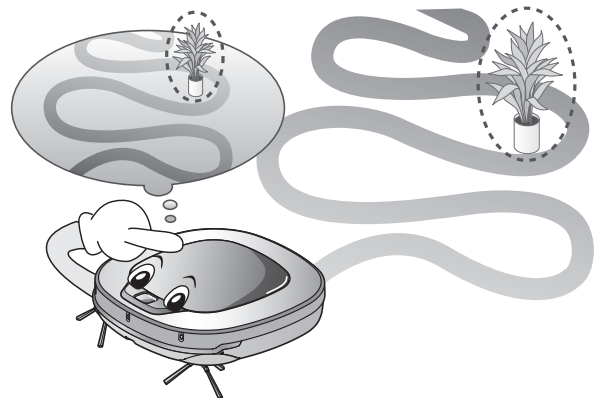

### Tip

#### • Precautions with Smart Operation

- This Learning mode enables memorizing locations with obstacles to bypass them. Robot Cleaner memorizes every aspect of the environment it was put under from when it started cleaning from the Home Station to the moment it finishes its course.
- Robot Cleaner learns the new conditions when the location of Home Station has been changed.
- If the learning mode is accepted, a voice message will say "The learning cleaning process is complete."

# MOP CLEANING (OPTION)

By attaching the ultra microfiber mop, you can effectively use the Robot Cleaner to remove dust.

When the mop plate is attached, the Robot Cleaner will not climb on to carpets or over thresholds, in order to prevent transferring dirt from the mop.

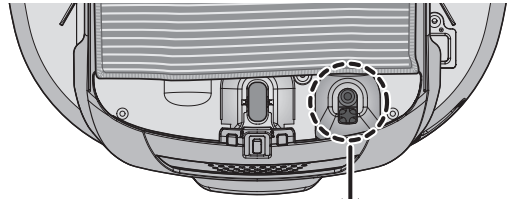

**⚠ Caution**  
Do not cover the bottom camera sensor by mop.

For mop cleaning, mount the mop and mop plate to the Robot Cleaner according to the following instructions:

1. Attach the ultra microfiber mop to the Velcro of the mop plate as shown in the figure.

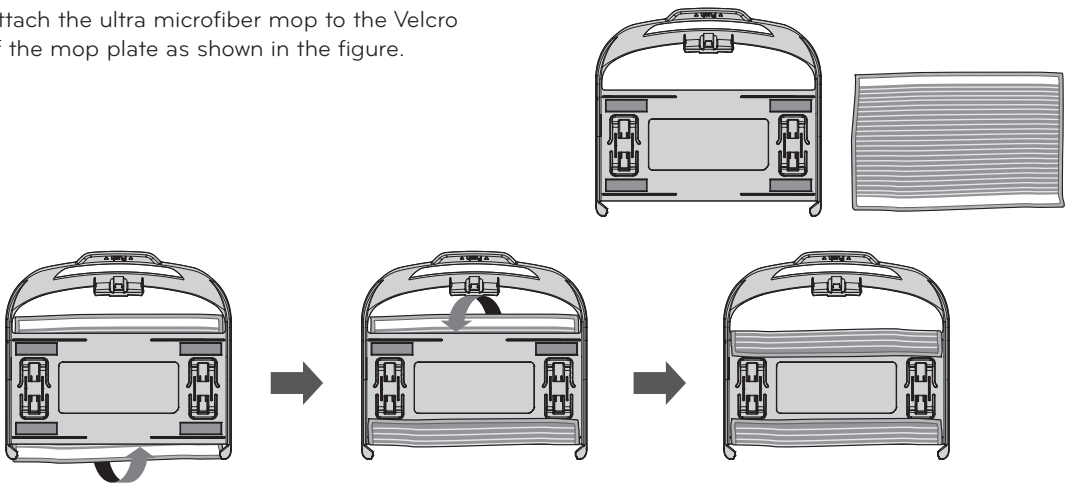

2. Firmly push the Mop Plate into the furrows until you hear a 'click' sound.

\* Note that, if the Mop Plate is not secured correctly, it may separate during the cleaning.

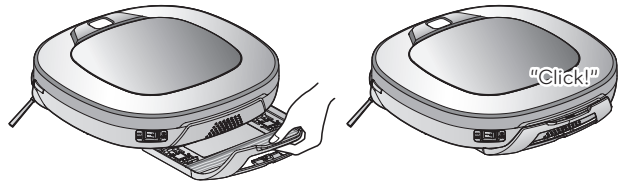

3. It is essential that the fixing hooks on the Mop Plate align correctly on to the fixing grooves on the underside of the cleaner.

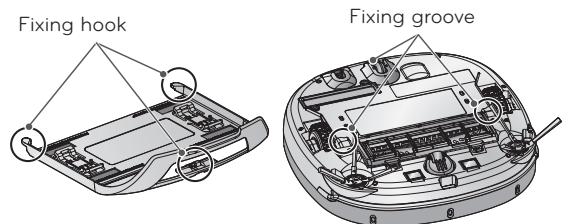

## Tip

- To avoid odors, wash any foreign material or dust off the mop after cleaning is complete.
- To avoid staining floors, do not use the ultra microfiber mop to clean when dirt is mixed with liquids such as coffee or ink.
- To avoid damage to carpets from the Velcro or dirt transfer from the mop, do not clean the carpet while the mop plate or mop is attached.
- Keep the ultra microfiber mop dry. Do not use it on wet surfaces.  
If there is moisture, it can interfere with the navigation.
- Smart Diagnosis feature is not available, when the Mop Plate is attached.
- Some models may not come with Microfibre Mop or Mop Plate.

# LOCATION SEARCH FUNCTION

The Robot Cleaner remembers its location while cleaning.

If the user moves the Robot Cleaner while it is operating, it will search for the location it was moved from by using its navigational location search function before continuing to clean.

- \* The navigating function will be activated after the Robot Cleaner adequately recognizes the cleaning environment.

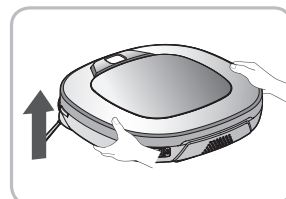

Change location

## Manual Relocation.

1. Locate the Robot Cleaner near the location where it was originally moved from.

- \* The location search is more effective when the Robot Cleaner is closer to the location where it was moved from.
- \* If it is moved from its original cleaning position by more than 1 m, it becomes difficult for the Robot Cleaner to search for its previous location.

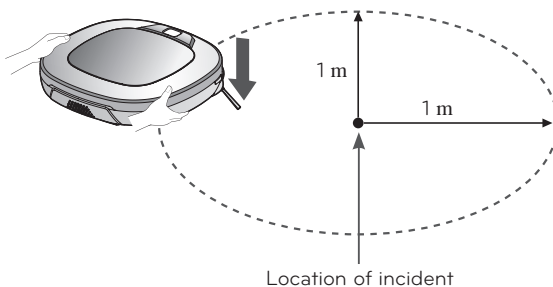

Location of incident

2. Press the START/STOP button on the Robot Cleaner or START button on the remote controller. Robot Cleaner will then start the location search function along with an audio guide.

- \* When the location search is successfully completed, it will continue cleaning from where it was moved. If the location search fails, it will start again from the beginning.

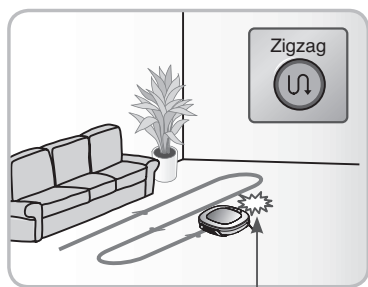

Location of incident

To improve its accuracy, do not stand near the HOM-BOT when it is in location search mode.

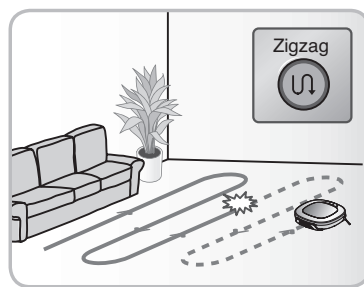

## Tip

- When the power is turned off after the location search function is set, the location search function will be canceled.
- Location search will be more effective when the Robot Cleaner is closer to the location where it was moved from.

# SMART DIAGNOSIS

Robot Cleaner uses this Smart Diagnosis feature to run a self-diagnosis.

If any irregularity is found from the diagnosis, please contact the local LG Electronics service center.

✳ **During Smart Diagnosis, the Robot Cleaner will move about within a 50 cm radius. So, make sure no objects are in the way within a 1 m radius around the Home Station, before starting Smart Diagnosis.**

1. Turn ON the Main Power Switch on the back after making sure the Robot Cleaner is attached to the Home Station.

✳ **Smart Diagnosis is only possible when the Robot Cleaner is attached to the Home Station.**



2. Press 'Diagnosis' button on the Remote Controller, then the process will start with a voice message which says "Starting HOM-BOT smart diagnosis. Please step away and remove any items within 1 meter, or about 3 feet."

✳ **If the Mop Plate is attached, the process will not be activated.**



3. When the Smart Diagnosis has successfully finished, Robot Cleaner will return back to the Home Station and inform the result through a voice message. After the voice message, pressing the 'HOME' button on the Remote Controller or main unit will allow the voice message to be repeated. To terminate the diagnosing process, press the 'Stop/OK' button on the Remote Controller or main unit.

✳ **After the Smart Diagnosis voice message, the Robot Cleaner will start recharging after 1 minute.**

✳ **If an error is detected with any of the Sensors whilst in Smart Diagnosis, a voice message will announce, and the unit will not return to the home station.**

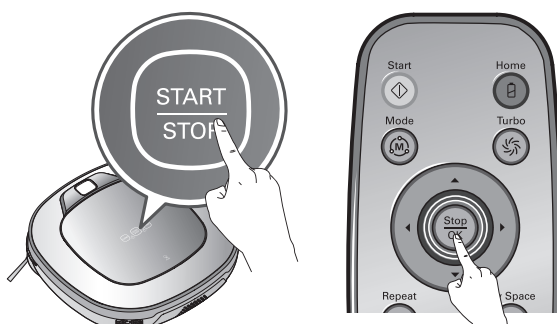

## Tip

- Be careful not to touch the Robot Cleaner or disturb its operation before Smart Diagnosis is complete. If it is accidentally interrupted, turn the main power switch OFF then ON again to resume the diagnosis.
- Smart Diagnosis will not be activated in each of the following cases. In each case, check the problem and try again.
  - Robot Cleaner is detached from Home Station
  - Battery level is insufficient
  - No Dust Bin Filter is fitted.
  - Mop Plate is attached

# SMART DIAGNOSIS

If a voice message is announced after Smart Diagnosis, refer to the following table to take proper actions.

Voice message	Measures (for reference)
Starting HOM-BOT smart diagnosis. Please step away and remove any items within 1 meter, or about 3 feet.	Clear any object within a 1 m radius around Home Station, and stay back until the diagnosis is complete.
HOM-BOT needs to be charging in order to activate smart diagnosis. Please dock the HOM-BOT to the home station.	Move Robot cleaner to the Home Station to recharge it.
Starting HOM-BOT smart diagnosis. Reservation has been cancelled for smart diagnosis. Please step away and remove any items within 1 meter, or about 3 feet.	
No defect found during diagnosis.	
Unable to initiate smart diagnosis due to a low battery. Please try again after battery is charged.	Try the Smart Diagnosis again after recharging the battery.
Please check that the dust bin and filter are properly installed.	Open the Dust Bin Cover and examine the bin.
HOM-BOT will not charge due to infrared sensor error. Please try smart diagnosis again after turning the main power switch on the back of the HOM-BOT 'Off' then 'On' again. If the problem continues, please contact LG Electronics customer care.	Run Smart Diagnosis again and, if the same message is announced, contact an LG Electronics service center.
HOM-BOT will not charge due to ultrasonic sensor error.	Run Smart Diagnosis again and, if the same message is announced, contact an LG Electronics service center.
HOM-BOT will not charge due to a problem with the cliff sensors on bottom. Please wipe the sensors clean.	Clean the three Cliff Sensors on the bottom at the front of the unit.
Please clean the camera sensor on bottom right side.	Clean the lens of Camera Sensor on the bottom-right
Please clean the obstacle detecting sensor windows on the left and right side of the HOM-BOT.	Clean the lens of the Obstacle Sensors on both the left and right hand sides.
A problem has been found on the Gyro Sensor. Please try smart diagnosis again after turning the main power switch on the back of the HOM-BOT 'Off' then 'On' again. If the problem continues, please contact LG Electronics customer care.	Run Smart Diagnosis again and, if the same message is announced, contact an LG Electronics service center.
Please check for foreign material on the left wheel.	Check for foreign materials on the left wheel.
Please check for foreign material on the right wheel.	Check for foreign materials on the right wheel.
A problem has been found on the left wheel sensor. Please try smart diagnosis again after turning the main power switch on the back of the HOM-BOT 'Off' then 'On' again. If the problem continues, please contact LG Electronics customer care.	Run Smart Diagnosis again and, if the same message is announced, contact an LG Electronics service center.
A problem has been found on the right wheel sensor. Please try smart diagnosis again after turning the main power switch on the back of the HOM-BOT 'Off' then 'On' again. If the problem continues, please contact LG Electronics customer care.	Run Smart Diagnosis again and, if the same message is announced, contact an LG Electronics service center.
A problem has been found with the brush. Please check for any foreign material.	Check for any foreign material stuck in the Brush.
A problem has been found in the suction motor. Please try smart diagnosis again after turning the main power switch on the back of the HOM-BOT 'Off' then 'On' again. If the problem continues, please contact LG Electronics customer care.	Run Smart Diagnosis again and, if the same message is announced, contact an LG Electronics service center.
A problem has been found in the acceleration sensor. Please try smart diagnosis again after turning the main power switch on the back of the HOM-BOT 'Off' then 'On' again. If the problem continues, please contact LG Electronics customer care.	Run Smart Diagnosis again and, if the same message is announced, contact an LG Electronics service center.
In order to listen to the smart diagnosis result again, please press the charging button. To stop, please press the stop button.	If you need to repeat the diagnosis result, press the 'Home' button, or press 'Stop/OK' button to finish the diagnosis.
Smart diagnosis mode will be turned off.	
Smart Diagnosis mode will not operate with the mop plate attached. Please try again after removing it.	Run Smart Diagnosis again after removing the Mop Plate.
Smart diagnosis has failed to complete its diagnostics. Please try again after turning the main power switch on the back of the HOM-BOT 'Off' then 'On' again.	Turn the main power switch OFF and then ON again to resume the diagnosis. Do NOT touch the robot or disturb its operation until the diagnosis is complete.
Please check if the charging terminal is damaged or dirty.	Clean the bottom of the machine and Charging Terminal on Home Station.

# CLEANING THE DUST BIN

If the dust bin is full, suction power can be reduced. Clean the dust bin before and after each cleaning session. Clean the dust bin using the following sequence:

1. Open the dust bin cover by pressing the PUSH button on the Robot Cleaner.

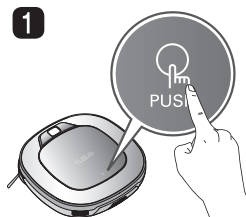

2. Grab the handle of the dust bin and pull it upward.

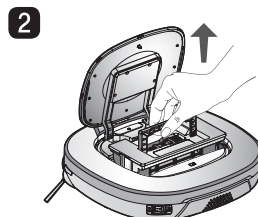

3. Pull the hook on the left of Filter Cover on the rear of Dust Bin to separate the filter and the sponge.

※ Note that separating the filter may result in dust dropping.

※ Refer to p.26 when cleaning the Dust Bin Filter.

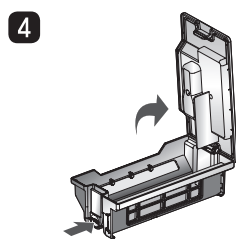
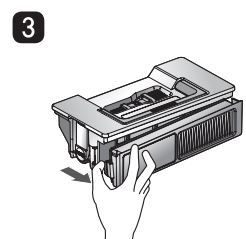

4. Lift the cover upward while pressing the separation button on the dust bin.

5. Empty the dust bin and clean it with a cleaning brush or under running water.

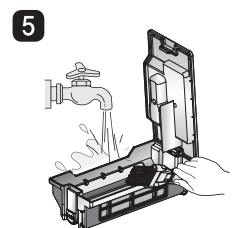

6. After cleaning with water, completely dry the dust bin in a well-ventilated area out of the direct sunlight.

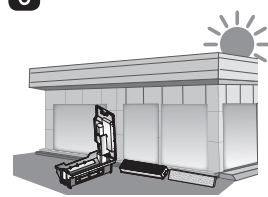

7. When reassembling or fitting the cleaned Dust Bin, close the cover and put in the Sponge and HEPA Filter.

※ Refer to p.26 for detailed assembly guides.

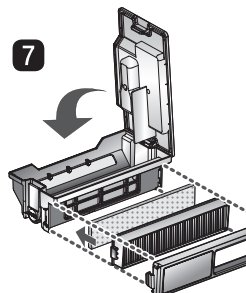

8. Put the dust bin into the Robot Cleaner and close the dust bin cover.

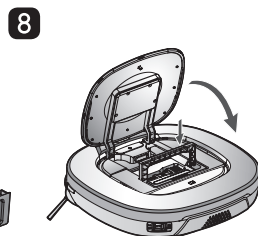

## Tip

- Operating the unit without Filters fitted to the dust bin can cause a motor malfunction not covered by warranty.
- After cleaning the Dust Bin, make sure to assemble the filter and fit it to the Dust Bin. If you initiate cleaning, with no filters fitted to the dust bin or Filter Cover not assembled, a voice message will be announced which says "Please check that the dust bin and filter are properly installed."
- Always ensure that the dust bin cover is refitted correctly after cleaning the dust bin so that it closes easily and accurately.

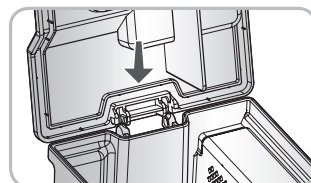

# CLEANING THE DUST BIN FILTER

The Dust Bin Filter consists of a HEPA Filter and Sponge Filter.  
Clean both the HEPA and Sponge filters as per the following sequence.

1. Pull the hook on the left of the HEPA Filter module on the rear side of Dust Bin to separate the HEPA Filter and the sponge.

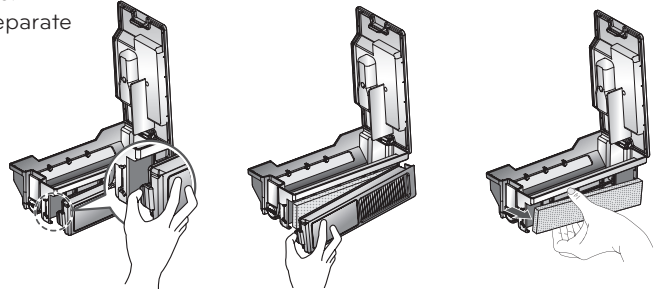

2. Thoroughly clean out the fine dust particles on the HEPA Filter, with a vacuum cleaner or cleaning brush.

※ Do NOT wash the HEPA Filter with water.  
Its suction power will be reduced.

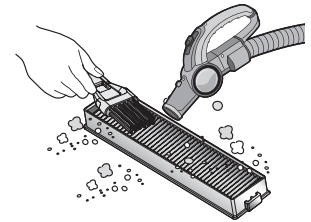

3. Use a cleaning brush to clean the Sponge Filter. If using water to clean it, allow it to dry completely in the shade before refitting.

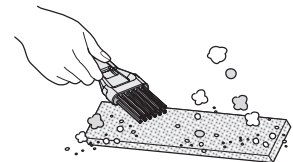

4. Assemble the HEPA and Sponge filters back onto the Filter Cover as per the following sequence.

※ Fit the rectangular locator on the HEPA Filter into the locating slot of the filter body.

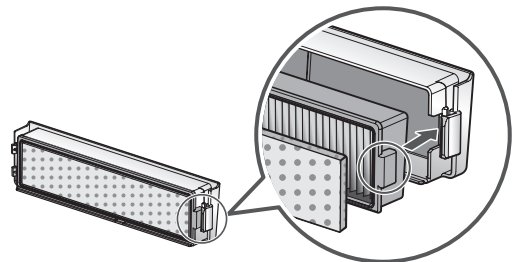

※ Be careful not to incorrectly assemble HEPA and Sponge Filter onto the Filter Cover.

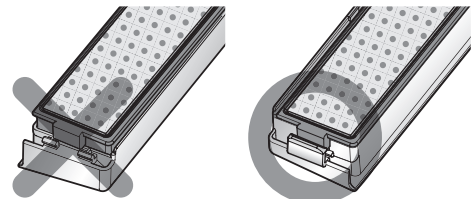

## Tip

- To preserve the performance of Robot Cleaner, clean the HEPA Filter at least once a week, with a brush or vacuum cleaner.
- If you run Robot Cleaner, with the Filter Cover assembled onto Dust Bin and without no filters inserted, it may involve dusts coming inside to cause a failure.

# CLEANING THE BRUSH

The rotating Brush, located on the bottom of Robot Cleaner, helps collect the dust. Clean the Brush as per the following sequence.

※ Before turning over the main unit, lay a soft cloth on the floor and remove the Dust Bin. Otherwise, the main unit can get scratches and dust will fall from Dust Bin.

- 1 Turn the Main Power Switch OFF before starting the clean. Put the Robot Cleaner upside down on a soft cloth.

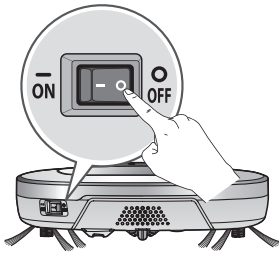

- 2 After checking for foreign materials, press down the Fixing Hook and pull it up to separate the brush Cover.

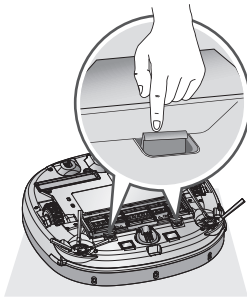

- 3 By using a cleaning tool, clear hairs and other debris and foreign materials on the Brush and from the 2 smaller jockey wheels.

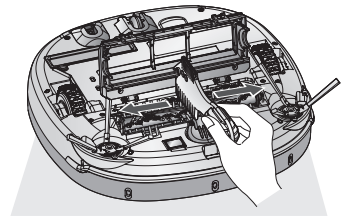

- 4 Push the Brush all the way into the yellow protrusion.

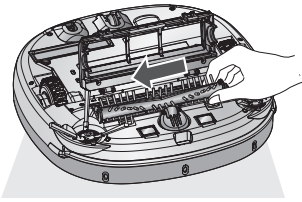

- 5 While pushing the Brush, lift the white protrusion part up to separate it from the main unit.

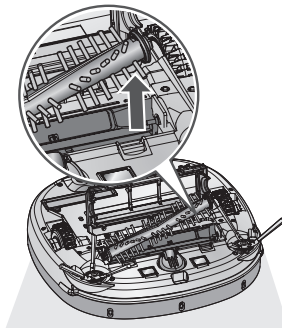

- 6 Carefully clean the Brush with a vacuum cleaner or scissors.

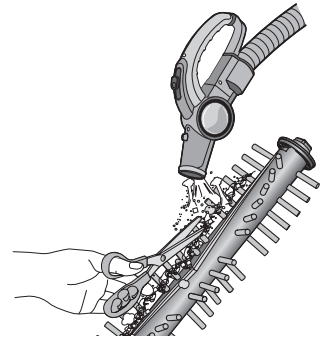

- 7 Fit the Fixing Hook (rectangular shape) on the side of the Brush into the slots, with the colors matching.

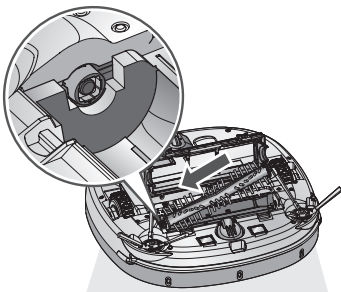

- 8 While pushing the Brush to the arrow direction, fit the Fixing Hook (rectangular shape) on the opposite side into the slot.

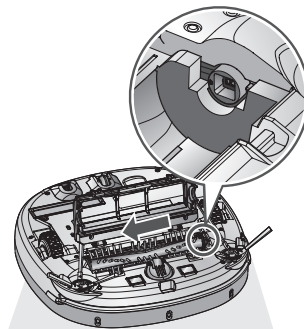

- 9 Press down and close the Cover until a 'crack' sound is heard from both sides of Fixing Hook.

※ Be careful not to trap the side brush bristles under the cover when closing it.

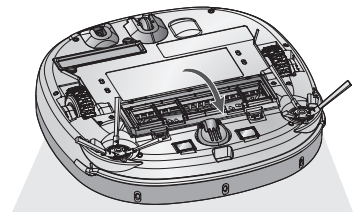

# CLEANING THE SENSOR/CHARGING TERMINAL

There are sensors on the Robot Cleaner that detect obstacles, stairways and the home station for charging the battery. In order to maintain the performance of the Robot Cleaner, regularly clean the sensors and charging terminal as follows:

1. Turn off the power switch on the bottom of the Robot Cleaner. Injury can be caused by the activation of the Robot Cleaner if the main power is not turned off.

2. Lay a smooth cloth on the floor, overturn the Robot Cleaner and put it on the cloth.

**\* Please make sure to remove the dust bin before rotating the main body. Otherwise, the dust in the dust bin may fall out.**

3. Use a smooth cloth or cleaning brush to wipe the dust off each cliff sensors, camera sensors and ultrasonic sensors and the charging terminal as described below.

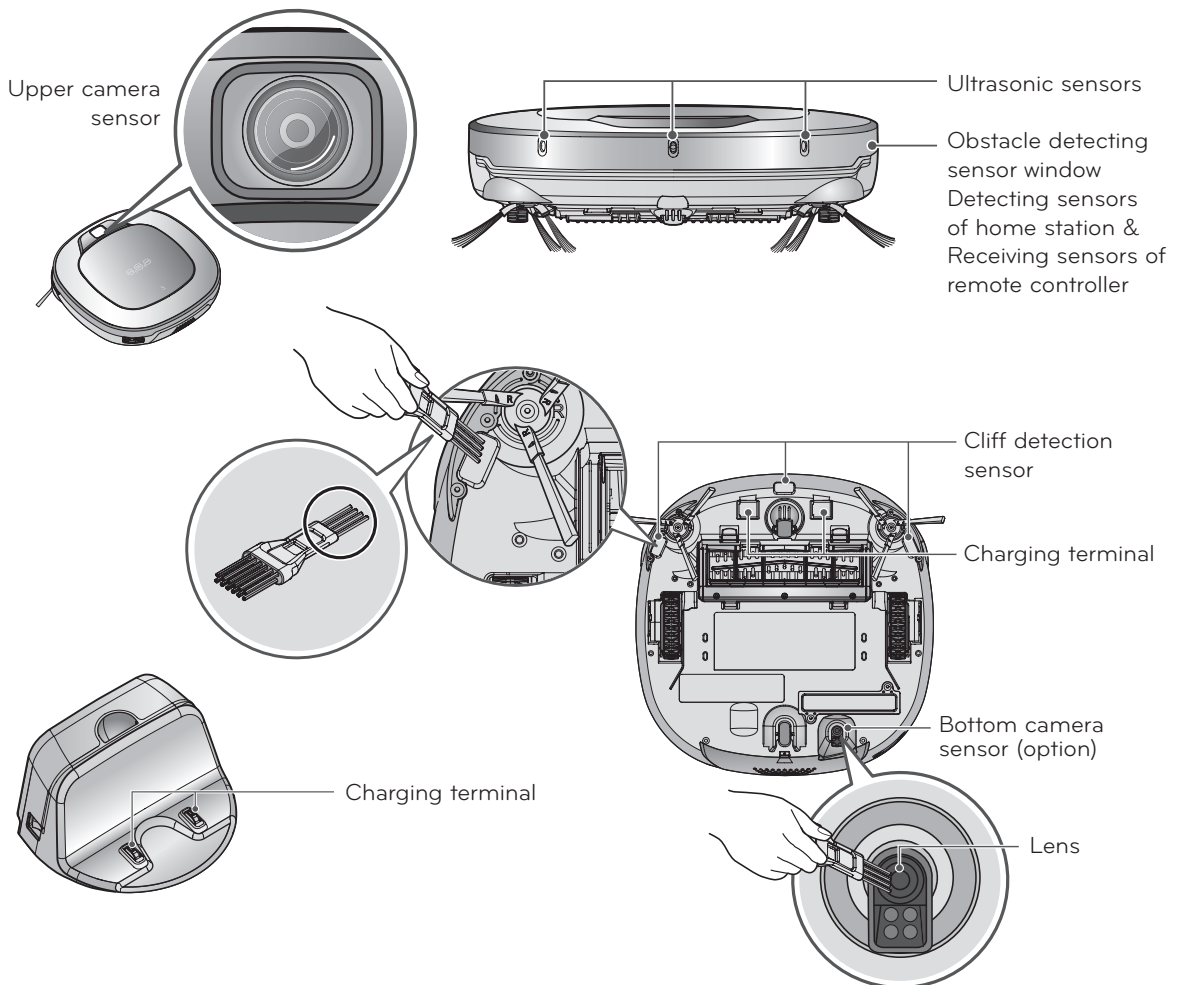
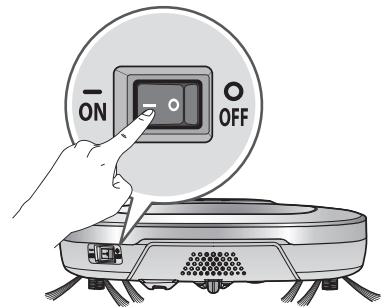

## Tip

- Do not clean the Robot Cleaner by directly spraying it with water, thinner, benzene, or any other liquids.
- Call the service center if the sensor or charging terminal is damaged. Sensor and terminal damage can cause the product to malfunction.
- To clean the sensor/charging terminal, use the cleaning brush.
- Some models may not have a Camera Sensor, on the bottom.

# CLEANING THE SIDE BRUSH

Foreign objects/materials such as hair can easily adhere to the side brush. Remove such materials at least once a week.

If excessive amounts of foreign materials are stuck to the brush, there is the risk of damage to the brushes.

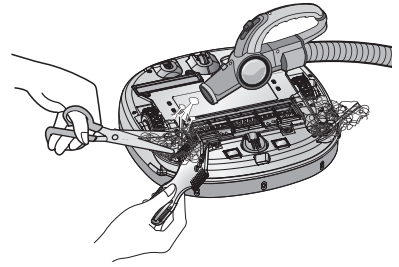

If the floor is rough or walls are frequently cleaned, the side brush may bend or become damaged. In this case, use the following method to straighten the side brush.

1. The following procedure is helpful in restoring deformed brushes.
2. Turn off the power by switching the main switch off on the rear of the unit.
3. Place the Robot Cleaner at the end of a table to make cleaning the side brush easier. Make sure that the Robot Cleaner is not in danger of falling.
4. Soak the side brush in warm water.
5. Press down on the side brush for about ten seconds so that it is completely submerged in the water.
6. Slowly wipe the side brush by sliding it through your hand.
7. Rotate the side brush and repeat steps 4-6 for each section of the brush.
8. Use the side brush only after it has completely dried.

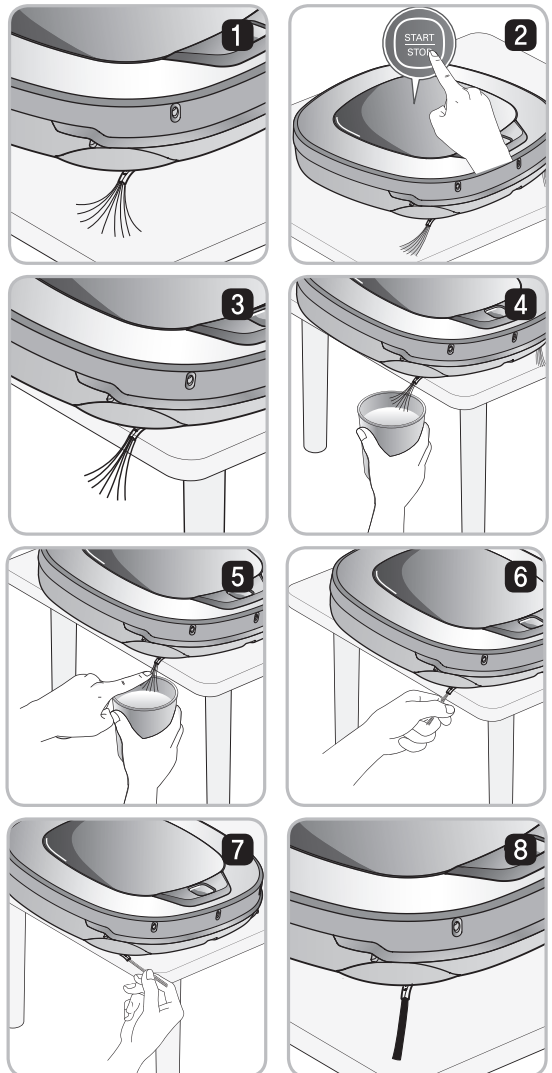

## Side Brush management

1. Remove the screws by using a driver and separate the Side Brush from the main unit.
2. Remove any hair after the separation.
3. Assemble the Side Brush by replacing it onto the bottom of the Robot Cleaner, with the 'R' and 'L' marking of the Brush matching the counterparts on Robot Cleaner.

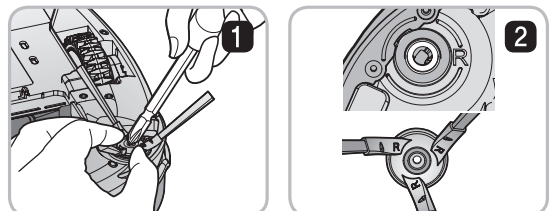

# CLEANING THE ULTRA MICROFIBER MOP (OPTION)

To avoid odors, dirt and dust should be washed off the mop after it is used for cleaning. Follow these directions to wash the ultra microfiber mop:

1. Separate the ultra microfiber mop from the mop plate.

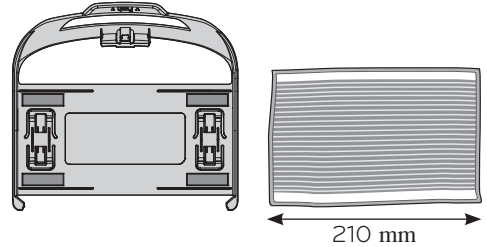

2. Carefully clean it with warm water.



3. Use the Mop after completely drying it in direct sunlight.

\* If the Mop is used in a damp or wet state, it will cause the Robot Cleaner to malfunction.

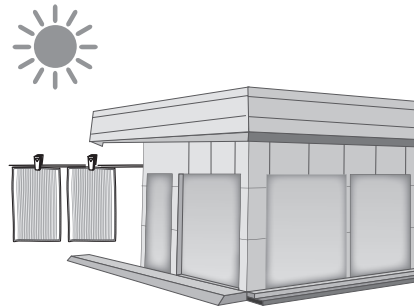

## Tip

- To avoid product malfunction, only use the ultra microfiber mop provided with the Robot Cleaner.
- Additional microfiber mops can be purchased by visiting a nearby LG Electronics service center.
- Some models may not come with Microfibre Mop or Mop Plate.

# TROUBLESHOOTING

## Upon a voice message, "The wheels are not touching the floor. Please move HOM-BOT onto flat floor."

A warning message will be given if a wheel does not contact the floor surface for any reason.

- Is a wheel trapped in the front door, balcony, stairway, etc?
  - ▶ Move the Robot Cleaner on to the flat floor.



## Upon a voice message, "Please remove any foreign material on the left/right wheel."

- Is any foreign material wound around the wheel?
  - ▶ Lay smooth cloth on the floor, overturn the Robot Cleaner, and put it on the cloth. Remove foreign material after observing the wheel.
  - ※ Please make sure to remove the dust bin before flipping the main body. Otherwise, the dust in the dust bin may fall out.

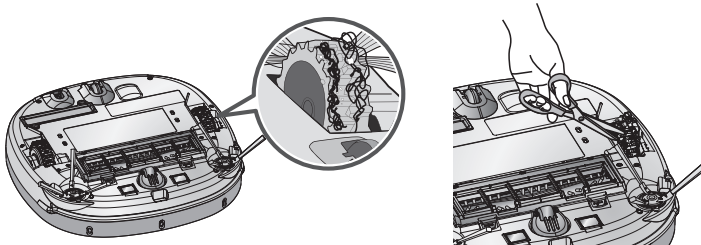

## Upon a voice message, "HOM-BOT cannot continue cleaning. Please check the area around it."

A warning message will be given if Robot Cleaner cannot go on cleaning due to any unfavourable condition.

- Is the Robot Cleaner stuck?
  - ▶ After removing the part that is stuck, place the Robot Cleaner on flat floor.

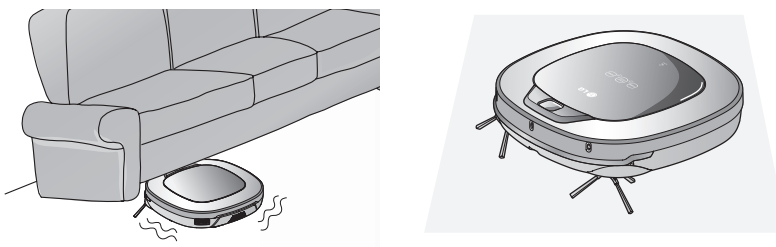

# TROUBLESHOOTING

## Upon a voice message, "Please check that the dust bin and filter are properly installed."

A warning message will be given if there is no Dust Bin or Filter Cover fitted.

- Is the Dust Bin fitted to the Robot Cleaner?
  - ▶ Open the Dust Bin Cover and check to ensure the Dust Bin is in place.
  - ▶ Do NOT leave the Dust Bin Cover open.

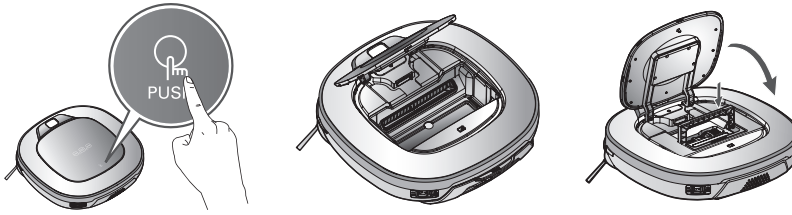

- Make sure the Filter Cover is assembled onto the Dust Bin.

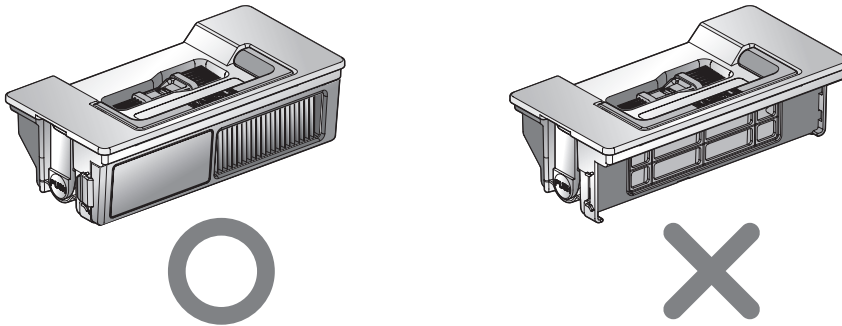

## Upon a voice message, "Battery is low. Please move HOM-BOT onto the home station to charge."

When the remaining amount of battery power is almost nil, the voice, "Battery is low", is generated.

- Initiate battery charging of the Robot Cleaner by moving it to the home station.
  - ▶ When the Robot Cleaner is attached to the docking station successfully, it will start the recharging with the recharging start melody.

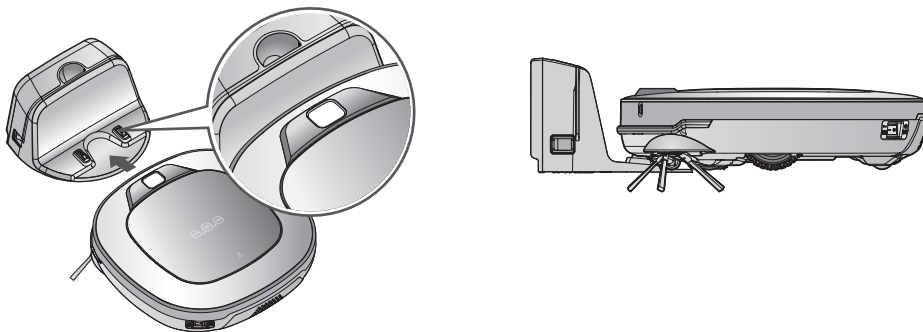

# TROUBLESHOOTING

Upon a voice message, "Please remove any foreign material from the brush on the bottom of the HOM-BOT."

A warning message will be given if foreign materials restrict the Brush's rotation.

Lay a soft cloth on the floor and put the Robot Cleaner upside down on it.

\* **Before turning over the main unit, remove the Dust Bin.**

**Otherwise, it will cause dust to fall from Dust Bin.**

• The brush is making a loud, abnormal sound.

▶ Confirm the correct assembly of the brush by checking the separation groove of the brush

▶ Remove the brush from Robot Cleaner and remove any foreign material from the brush.

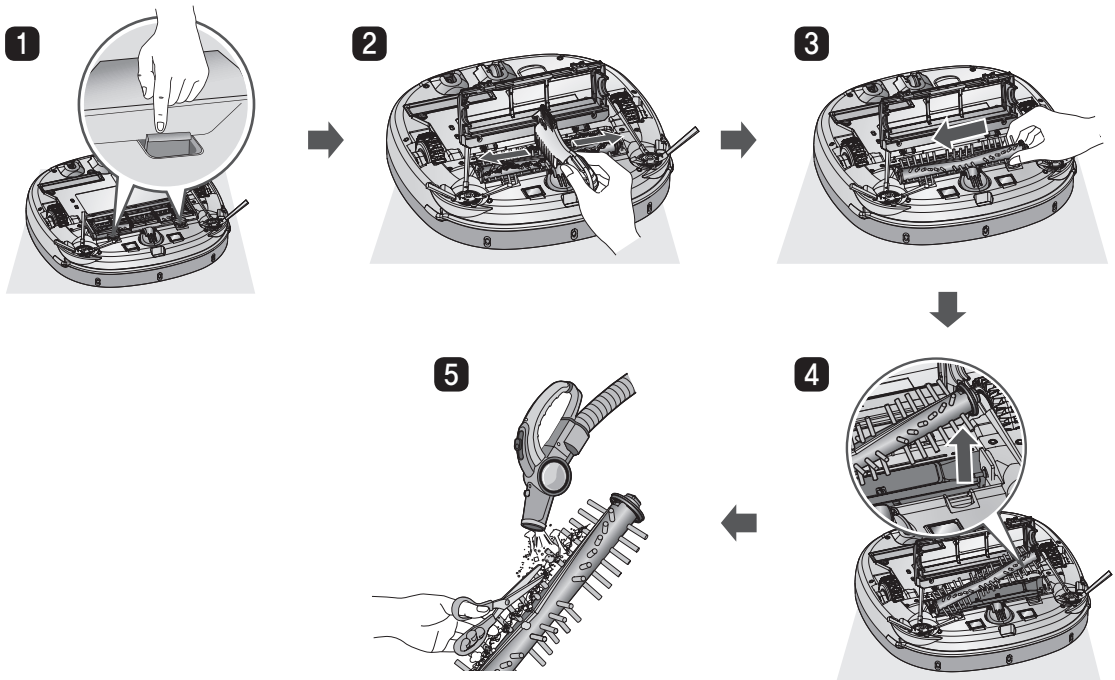

• The brush or side brush is stuck.

▶ Remove any foreign materials such as cables, thread or hair caught in the side brush or the brush.

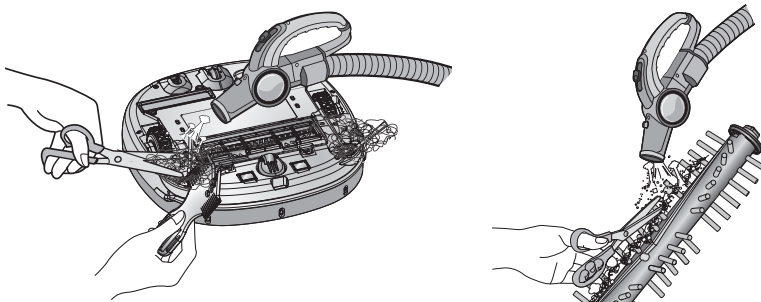

\* For a more detailed description of this process, refer to the instructions on page 27, 29.

# BEFORE YOU CALL FOR SERVICE

Confirm before reporting the failure of Robot Cleaner.

Problem	Solutions (Reference page)
The power supply cannot be turned on.	Check that the power switch is turned on. (Page 15)
The power supply automatically turns off.	This is not a failure. Robot Cleaner has its own power saving function. If it is not used for ten minutes after the power supply is turned on, the power will automatically turn off. (Page 17)
The Robot Cleaner will not charge.	<ul style="list-style-type: none"> <li>▶ Check whether the main power switch is turned on.</li> <li>▶ Remove objects around the home station. (Page 15)</li> <li>▶ Confirm that the power supply is connected to the home station. (Page 14)</li> <li>▶ Wipe the charging terminal with a dry cloth.</li> </ul>
Suction power becomes weak.	<ul style="list-style-type: none"> <li>▶ Check whether there is foreign material blocking the suction port. (Page 27)</li> <li>▶ Empty the dust bin. (Page 25)</li> <li>▶ Clean the dust bin filter. (Page 26)</li> </ul>
Noise becomes louder.	<ul style="list-style-type: none"> <li>▶ Confirm that the dust bin has been mounted properly.</li> <li>▶ Confirm that the dust bin filter has been mounted properly. (Page 26)</li> <li>▶ Check whether foreign material is caught in the brush. (Page 27)</li> </ul>
The Robot Cleaner will not activate.	<ul style="list-style-type: none"> <li>▶ Confirm that the power switch is turned on. (Page 15)</li> <li>▶ Confirm that the battery has been charged. (Page 17)</li> </ul>
The brush does not rotate.	<ul style="list-style-type: none"> <li>▶ Clean the brush. (Page 27)</li> <li>▶ Confirm that the brush has been mounted properly. (Page 27)</li> </ul>
Movements or travel path are abnormal.	<ul style="list-style-type: none"> <li>▶ Carefully wipe the sensor with a smooth cloth. (Page 28)</li> <li>▶ If the ultra microfiber mop is attached, confirm that it is mounted properly. (Page 21)</li> <li>▶ Turn the power switch off and on.</li> </ul>
The Robot Cleaner cannot be activated with the remote control.	<ul style="list-style-type: none"> <li>▶ Replace the remote control batteries. (Page 12)</li> <li>▶ Confirm that the control is within the coverage area of the main unit, which is less than 3 m. (Page 12)</li> <li>▶ Check whether the main power switch is turned on. (Page 15)</li> </ul>

# PRODUCT SPECIFICATIONS



Item/Model	LG Robot Cleaner VR634*, VR635* ser.
External Dimensions	340 mm × 340 mm × 89 mm
Weight	3 kg
Power Consumption	18 W
Battery (Fully Charging)	DC 16.8 V
Traveling Velocity	350 mm/s (Maximum)
Use Time	Approx. 100 minutes (Based on general wooden floor)
Charging Time	3 hours
Main Functions	Turbo Mode Learning Mode Obstacle Sensing Anti-Plunge function Error Displaying Navigation Auto/Manual Recharging Dry mop (option) Corner Clean Voice Messaging Map Drawing Repeat Cleaning My Space Cleaning Zigzag Cleaning

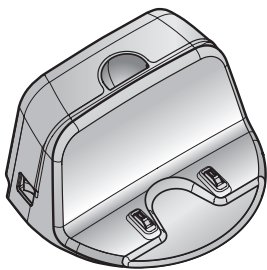

Item/Model	Home Station
External Dimensions	236 mm × 181 mm × 128 mm
Rating	230 V~ 50 Hz
Output Voltage/Current	DC 17.1 V / 1.1 A
Power Consumption	23 W

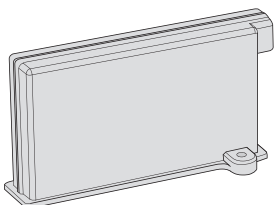

Item/Model	Battery
Type	Lithium Battery

# REFERENCE ITEMS

## Open source software notice

To obtain the source code under GPL, LGPL, MPL and other open source licenses, that is contained in this product, please visit <http://opensource.lge.com>.

In addition to the source code, all referred license terms, warranty disclaimers and copyright notices are available for download.

## Dis/Assembling the battery

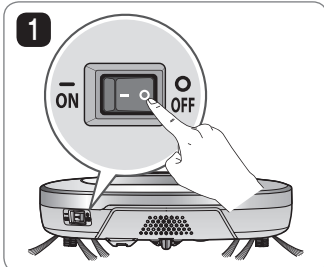

Turn off the main power switch on the back-left side of the Robot Cleaner.

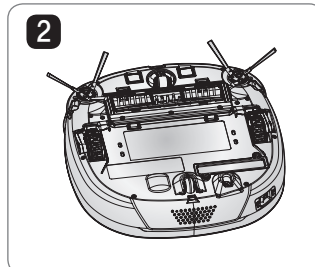

Place a soft cloth on the floor, remove the dust bin, and flip the Robot Cleaner over.

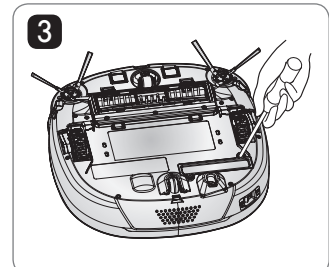

Remove the screw by using the screwdriver.

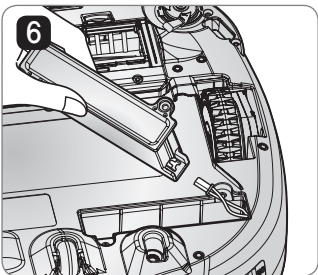

Please assemble the battery in the reverse order.

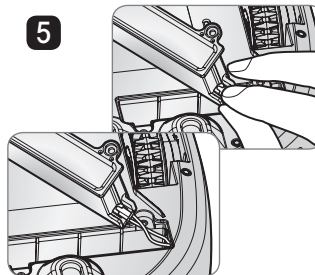

Separate the wire from the battery while pressing the connector hook.

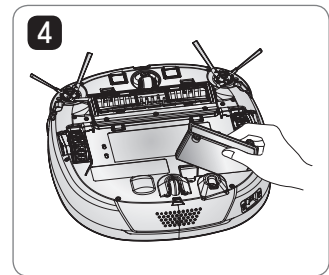

Remove the battery from the device.

## WARNING

**Please be careful of fire, explosion, electric shock, or breakdown.**

- Do not charge this Battery Pack(Pack hereafter) with any other type of charger than the one originally provided with the charger.
- Do not damage the Pack in such ways as drop, crush, puncture, cut or short external contacts.
- Do not attempt to disassembly the pack In any case. When the Pack is damaged or malfunctioning, bring it to the service center.
- Do not place this pack near a heat source or do not dispose of in fire or water.
- Please keep the Pack away from damp or wet environment when the pack is charged.
- Please keep away from children, infant or pets.



### **Disposal of waste batteries/accumulators**

1. When this crossed-out wheeled bin symbol is attached to batteries/accumulators of Your product it means they are covered by European Directive 2006/66/CE.
2. This symbol may be combined with chemical symbols for mercury(Hg), cadmium(Cd) or lead(Pb) if the battery Contains more than 0.0005% of mercury, 0.002% of cadmium or 0.004% of lead.
3. All batteries/accumulators should be disposed separately from the municipal waste stream via designated collection facilities appointed by the government or the local authorities.
4. The correct disposal of Your old batteries/accumulators will help to prevent potential negative consequences for the environment, animal and human health.
5. For more detailed information about disposal of Your old batteries/accumulators, please contact Your city office, waste disposal service or the shop where You purchased the product.



### **Disposal of your old appliance**

1. When this crossed-out wheeled bin symbol is attached to a product it means the product is covered by the European Directive 2002/96/EC.
2. All electrical and electronic products should be disposed of separately from the municipal waste stream via designated collection facilities appointed by the government or the local authorities.
3. The correct disposal of your old appliance will help prevent potential negative consequences for the environment and human health.
4. For more detailed information about disposal of your old appliance, please contact your city office, waste disposal service or the shop where you purchased the product.

