



ENGLISH

# OWNER'S MANUAL

# Micro Hi-Fi System

Please read this manual carefully before operating your set and retain it for future reference.

CM2630B (CM2630B, CMS2630F)



# Safety Information



**CAUTION:** TO REDUCE THE RISK OF ELECTRIC SHOCK DO NOT REMOVE COVER (OR BACK) NO USER-SERVICEABLE PARTS INSIDE REFER SERVICING TO QUALIFIED SERVICE PERSONNEL.



This lightning flash with arrowhead symbol within an equilateral triangle is intended to alert the user to the presence of uninsulated dangerous voltage within the product's enclosure that may be of sufficient magnitude to constitute a risk of electric shock to persons.



The exclamation point within an equilateral triangle is intended to alert the user to the presence of important operating and maintenance (servicing) instructions in the literature accompanying the product.

**WARNING:** TO PREVENT FIRE OR ELECTRIC SHOCK HAZARD, DO NOT EXPOSE THIS PRODUCT TO RAIN OR MOISTURE.

**WARNING:** Do not install this equipment in a confined space such as a book case or similar unit.

**CAUTION:** Do not block any ventilation openings. Install in accordance with the manufacturer's instructions.

Slots and openings in the cabinet are provided for ventilation and to ensure reliable operation of the product and to protect it from over heating. The openings shall be never be blocked by placing the product on a bed, sofa, rug or other similar surface. This product shall not be placed in a built-in installation such as a bookcase or rack unless proper ventilation is provided or the manufacturer's instruction has been adhered to.

**CAUTION:** This product employs a Laser System. To ensure proper use of this product, please read this owner's manual carefully and retain it for future reference. Shall the unit require maintenance, contact an authorized service center. Use of controls, adjustments or the performance of procedures other than those specified herein may result in hazardous radiation exposure. To prevent direct exposure to laser beam, do not try to open the enclosure.

### CAUTION concerning the Power Cord

Most appliances recommend they be placed upon a dedicated circuit;

That is, a single outlet circuit which powers only that appliance and has no additional outlets or branch circuits. Check the specification page of this owner's manual to be certain. Do not overload wall outlets. Overloaded wall outlets, loose or damaged wall outlets, extension cords, frayed power cords, or damaged or cracked wire insulation are dangerous. Any of these conditions could result in electric shock or fire. Periodically examine the cord of your appliance, and if its appearance indicates damage or deterioration, unplug it, discontinue use of the appliance, and have the cord replaced with an exact replacement part by an authorized service center. Protect the power cord from physical or mechanical abuse, such as being twisted, kinked, pinched, closed in a door, or walked upon. Pay particular attention to plugs, wall outlets, and the point where the cord exits the appliance. To disconnect power from the mains, pull out the mains cord plug. When installing the product, ensure that the plug is easily accessible.

This device is equipped with a portable battery or accumulator.

**Safety way to remove the battery or the battery from the equipment:** Remove the old battery or battery pack, follow the steps in reverse order than the assembly. To prevent contamination of the environment and bring on possible threat to human and animal health, the old battery or the battery put it in the appropriate container at designated collection points. Do not dispose of batteries or battery together with other waste. It is recommended that you use local, free reimbursement systems batteries and accumulators. The battery shall not be exposed to excessive heat such as sunshine, fire or the like.

**CAUTION:** The apparatus shall not be exposed to water (dripping or splashing) and no objects filled with liquids, such as vases, shall be placed on the apparatus.

### Disposal of your old appliance



1. When this crossed-out wheeled bin symbol is attached to a product it means the product is covered by the European Directive 2002/96/EC.
2. All electrical and electronic products should be disposed of separately from the municipal waste stream via designated collection facilities appointed by the government or the local authorities.
3. The correct disposal of your old appliance will help prevent potential negative consequences for the environment and human health.
4. For more detailed information about disposal of your old appliance, please contact your city office, waste disposal service or the shop where you purchased the product.

### Disposal of waste batteries/accumulators



1. When this crossed-out wheeled bin symbol is attached to batteries/accumulators of Your product it means they are covered by European Directive 2006/66/EC.
2. This symbol may be combined with chemical symbols for mercury(Hg), cadmium(Cd) or lead(Pb) if the battery Contains more that 0.0005% of mercury,0.002% of cadmium or 0.004% of lead.
3. All batteries/accumulators should be disposed separately from the municipal waste stream via designated collection facilities appointed by the government or the local authorities.
4. The correct disposal of Your old batteries/accumulators will help to prevent potential negative consequences for the environment, animal and human health.
5. For more detailed information about disposal of Your old batteries/accumulators, please contact Your city office, waste disposal service or the shop where You purchased the product.

## LG Bluetooth Remote

You can control this player with your iPhone or Android phone via Bluetooth. This player and your phone must be connected to Bluetooth. Visit “Apple App Store” or “Google Android Market (Google Play Store)”. And use this QR code to search for “LG Bluetooth Remote” app. For detailed information, refer to the 21 page.



(Apple iOS)



(Android OS)

# Table of Contents

## 1 Getting Started

---

- 2 Safety Information
- 4 LG Bluetooth Remote
- 6 Unique Features
- 6 Accessories
- 7 Playable file Requirement
- 8 Remote Control
- 9 Front Panel
- 10 Rear Panel

## 2 Connecting

---

- 11 Connecting to speakers
  - 11 – Attaching the speakers to the unit
- 11 Antenna Connection
- 12 Optional Equipment Connection
  - 12 – USB Connection
  - 12 – PORT. IN Connection
  - 13 – PHONES Connection

## 3 Operating

---

- 14 Basic Operations
  - 14 – CD/USB Operations
  - 14 – Selecting a folder and an MP3/WMA
- 15 Other Operation
  - 15 – Programmed Playback
  - 15 – Deleting an MP3/WMA file
  - 16 – Displaying file information
  - 16 – Turn off the sound temporarily
  - 16 – DEMO
  - 16 – Auto Power Down
- 16 Radio Operations
  - 16 Listening to the radio
    - 16 – Improving poor FM reception
    - 17 – Presetting the Radio Stations
    - 17 – Deleting all the saved stations
- 17 Sound adjustment
  - 17 – Setting the sound mode
- 18 Setting the Clock
  - 18 – Using your player as an alarm clock
  - 19 – Sleep Timer Setting

- 19 – Dimmer
- 19 Using a Bluetooth wireless technology
- 20 – Listening to music of a Bluetooth device
- 21 Using LG Bluetooth Remote app

## 4 Troubleshooting

---

- 23 Troubleshooting

## 5 Appendix

---

- 24 Trademarks and Licenses
- 25 Specifications
- 26 Maintenance
  - 26 – Notes on Discs
  - 26 – Handling the Unit

1

2

3

4

5

1

Getting Started

## Unique Features

### Portable In

Listens to music from your portable device. (MP3, Notebook, etc)

### Timer

Sets alarm which go off at desired time.

### Bluetooth®

Listens to music stored on your Bluetooth device.

### Time Sync

Sets your unit's clock automatically by using your Bluetooth device. (LG Bluetooth Remote app)

## Accessories

Please check and identify the supplied accessories.

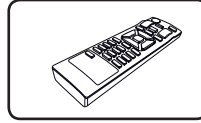

Remote Control (1)

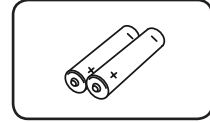

Battery (2)

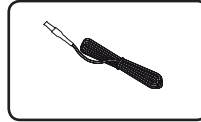

FM Antenna (1)

# Playable file Requirement

## MP3/ WMA music file requirement

MP3/ WMA file compatibility with this unit is limited as follows :

- Sampling frequency : within 8 to 48 kHz (MP3), within 8 to 48 kHz (WMA)
- Bit rate : within 8 to 320 kbps (MP3), 40 to 192 kbps (WMA)
- Maximum files : Under 999
- File extensions : “.mp3”/ “.wma”
- CD-ROM file format : ISO9660/ JOLIET
- You have to set the disc format option to [Mastered] in order to make the discs compatible with the LG players when formatting rewritable discs. When setting the option to Live File System, you cannot use it on LG players. (Mastered/ Live File System : Disc format system for Windows Vista)

## Compatible USB Devices

- MP3 Player : Flash type MP3 player.
- USB Flash Drive :  
Devices that support USB2.0 or USB1.1.
- The USB function of this unit does not support all USB devices.

## USB device requirement

- Devices which require additional program installation when you have connected it to a computer, are not supported.
- Do not extract the USB device while in operation.
- For a large capacity USB, it may take longer than a few minutes to be searched.
- To prevent data loss, back up all data.
- If you use a USB extension cable or USB hub, the USB device is not recognized.
- Using NTFS file system is not supported. (Only FAT(16/ 32) file system is supported.)
- This unit is not supported when the total number of files is 1 000 or more.
- External HDD, Card readers, Locked devices, or hard type USB devices, mobile phone are not supported.
- USB port of the unit cannot be connected to PC. The unit cannot be used as a storage device.
- Some USB may not work with this unit.

## Remote Control

1  
Getting Started

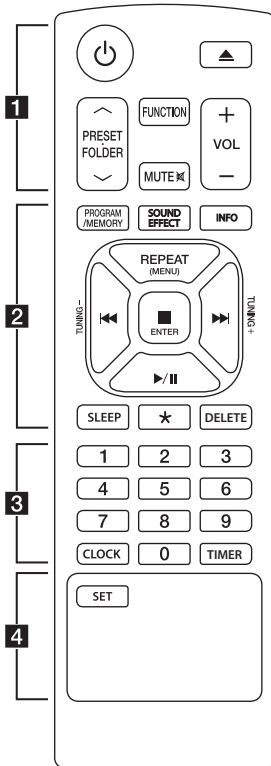

### Battery Installation

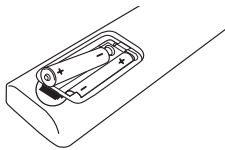

Remove the battery cover on the rear of the Remote Control, and insert two (size AAA) batteries with  $\oplus$  and  $\ominus$  matched correctly

..... **1** .....

**Power** (Power): Switches the unit ON or OFF.

**Open/Close** (Open/Close): Ejects the disc from slot loader.

**PRESET FOLDER  $\wedge$ /V** :

- Searches for a folder of MP3/WMA files. When a CD/USB containing MP3/WMA files in several folders is being played, press **PRESET FOLDER  $\wedge$ /V** to select the folder you want to play.

- Chooses a preset number for a radio station.

**FUNCTION** : Selects the function and input source.

**MUTE**  $\boxtimes$  : Mutes the sound.

**VOL +/-** : Adjusts speaker volume.

..... **2** .....

**PROGRAM/MEMORY** :

- Stores radio stations.
- Creates a playlist you want to listen to.

**SOUND EFFECT** : Chooses sound impressions.

**INFO** : Sees information about your music. MP3 files often come with ID3 tags. The tag gives the Title, Artist, Album or Time information.

**REPEAT (MENU)** : Listens to your tracks/files repeatedly or randomly.

**Navigation** (Skip/Search) :

- Skips Fast backward or Forward.

- Searches for a section within a track/file.

**TUNING +/-** :

Selects the radio stations.

**ENTER** :

- Stops playback.

- Cancels DELETE function.

- Confirms the clock and the alarm setting

**Play/Pause** (Play/Pause) :

- Starts or pauses playback.

- Starts or pauses playback.

**SLEEP** : Sets the system to turn off automatically at a specified time.(Dimmer : The display window will be darkened by half)

**\*** : The button is not available for any function.

**DELETE** : Deletes MP3/WMA files. (USB only)

..... **3** .....

**0 to 9 numerical buttons** :

Selects numbered tracks, files, or preset number.

**CLOCK** : Sets a clock and checks a time.

**TIMER** : Uses your player as an alarm clock.

..... **4** .....

**SET** :

Confirms the clock and the alarm setting

## Front Panel

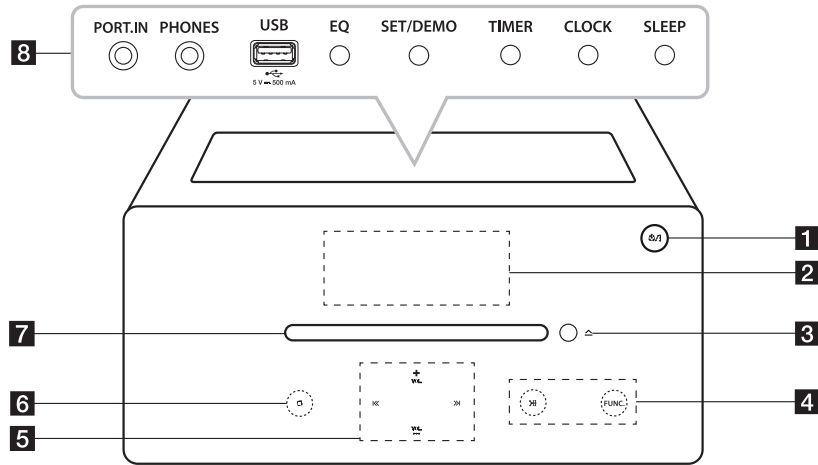

- 1** (Power)  
Switches the unit ON or OFF.
- 2** Display Window
- 3** (Insert/Eject)  
Inserts or ejects a disc.
- 4** (Play/Pause)  
- Starts and pauses playback.  
- Selects STEREO/MONO.  
**FUNC.**  
Selects the function and input source.
- 5** (Skip/Search)  
- Searches backward or forward.  
- Skips to the previous/next track/file.  
**VOL.+/-**  
Adjusts volume level.
- 6** (Stop)  
- Stops playback.  
- Cancels DELETE function.
- 7** Disc slot  
Loads a disc.
- 8** **PORT.IN**  
Listens to music from your portable device.
- PHONES**  
Listens to music with your headphone.  
(3.5 mm)
- USB Port**  
Plays the audio files by connecting the USB device.
- EQ**  
Chooses sound impressions.
- SET/DEMO**  
- Confirms the setting.  
- Demonstrates each of functions.
- TIMER**  
Uses your player as an alarm clock.
- CLOCK**  
Sets the clock and checks the time.
- SLEEP**  
Sets the system to turn off automatically at a specified time.  
(Dimmer : The display window will be darkened by half.)

## Rear Panel

1  
Getting Started

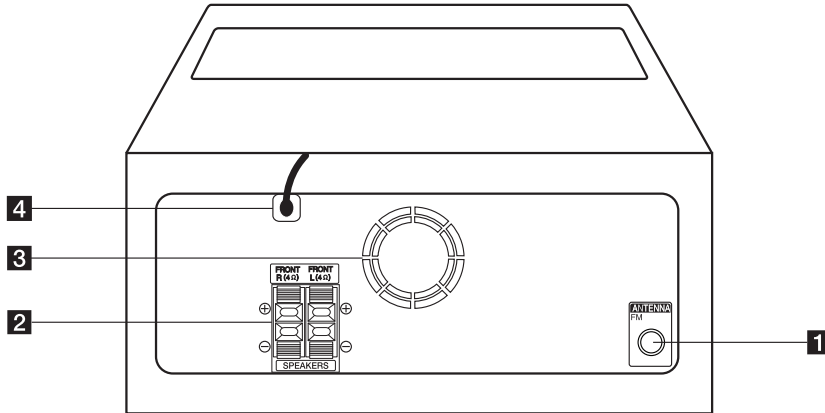

- 1 ANTENNA FM**  
Connects the FM wired antenna.
- 2 SPEAKERS terminal (R/L)**
- 3** Cooling fan
- 4** Power cord

### Caution

Precautions in using the touch buttons

- Use the touch buttons with clean and dry hands.
  - In a humid environment, wipe out any moisture on the touch buttons before using.
- Do not press the touch buttons hard to make it work.
  - If you apply too much strength, it can damage the sensor of the touch buttons.
- Touch the button that you want to work in order to operate the function correctly.
- Be careful not to have any conductive material such as metallic object on the touch buttons. It can cause malfunctions.

## Connecting to speakers

### Attaching the speakers to the unit

To connect the cable to the unit, press each plastic finger pad to open the connection terminals on the unit. Insert the wire and release the finger pad.

Connect the black wire to the terminals marked - (minus) and the other end to the terminals marked + (plus).

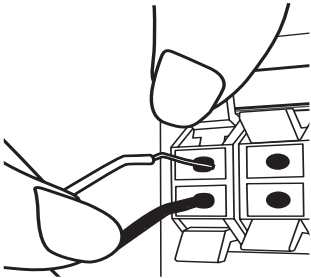

#### ⚠ Caution

The speakers contain magnet parts, so color irregularity may occur on the TV screen or PC monitor screen. Please use the speakers far away from either TV screen or PC monitor.

Color	Position
Red	Front right
White	Front left

## Antenna Connection

Connect the FM Wire antenna to ANTENNA FM connector.

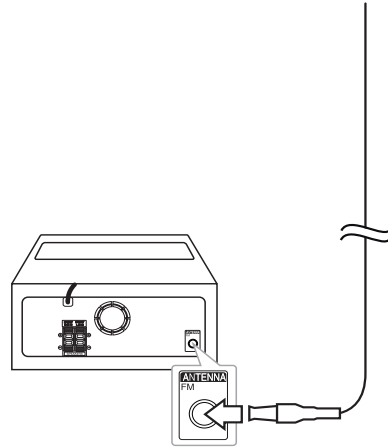

#### ⚠ Note

Be sure to fully extend the FM wire antenna.

2

Connecting

## Optional Equipment Connection

### USB Connection

Connect the USB port of USB Memory (or MP3 player, etc.) to the USB port on the unit.

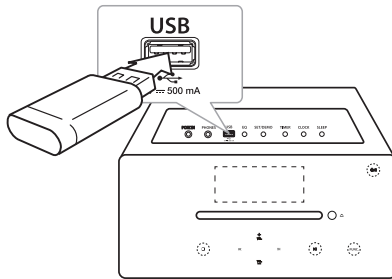

#### ! Note

Removing the USB Device from the unit

1. Choose a different function/mode or press **ENTER** or **□** twice in a row.
2. Remove the USB device from the unit.

### PORT. IN Connection

The unit can be used to play the music from many types of external device. (Portable cable is not supplied as an accessory with this unit.)

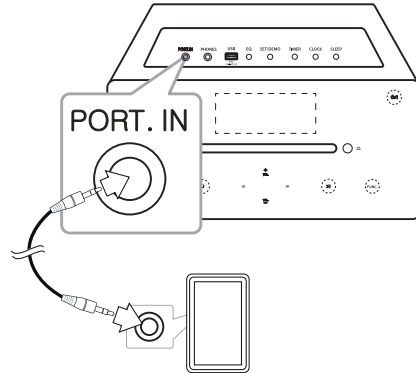

1. Connect the external device to the **PORT. IN** connector of the unit.
2. Turn the power on by pressing **⏻** or **⏻/|**.
3. Select the PORTABLE function by pressing **FUNCTION** or **FUNC.**
4. Turn the external device on and start playing it.

## PHONES Connection

Connect a pair of stereo headphones (Ø 3.5 mm phone plug) to PHONES jack on the unit for private listening. (Headphones are not supplied as an accessory with this unit.)

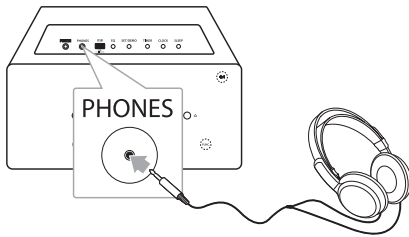

### ! Note

You can't hear any sound from speakers, while the headphones plug is inserted in the PHONES jack.

## Basic Operations

### CD/USB Operations

1. Insert a disc by pressing **▲** or connect the USB device to the USB port.
2. Select the CD or USB function by pressing **FUNCTION** on the remote control or **FUNC.** on the unit.
3. Select a track/file you want to play by pressing **◀◀/▶▶** on the remote control or **◀◀/▶▶** on the unit.

To	Do this
Stop	Press <b>■ENTER</b> or <b>□</b> .
Playback	Press <b>▶/  </b> or <b>&gt;  </b> .
Pause	During playback, Press <b>▶/  </b> or <b>&gt;  </b> .
Skipping to the next/previous track/file	During playback, press <b>▶▶</b> or <b>&gt;&gt; </b> to go to the next track/file.
	Playing less than 2 seconds, press <b>◀◀</b> or <b>◀◀</b> to go to the previous track/file. Playing after 3 seconds, press <b>◀◀</b> or <b>◀◀</b> to go to the beginning of the track/file.
Searching for a section within a track/file	Press and hold <b>◀◀/▶▶</b> or <b>◀◀/▶▶</b> during playback and release it at the point you want to listen to.
Searching for a section within a folder	Press <b>PRESETFOLDER ▲/▼</b> on the remote control.
Playing repeatedly or randomly	Press <b>REPEAT(MENU)</b> on the remote control repeatedly, the display window will be changed in the following order, RPT1 -> RPT DIR (only MP3/WMA) -> RPT ALL -> RANDOM -> OFF

### Selecting a folder and an MP3/WMA

1. **PRESETFOLDER ▲/▼** on the remote control repeatedly until a desired folder appears.
2. Press **▶/||** to play it. The first file of folder will be played. (During playback, if you selecting a folder you want, this step is not necessary.)

#### ! Note

- USB Folders/Files are recognized as below

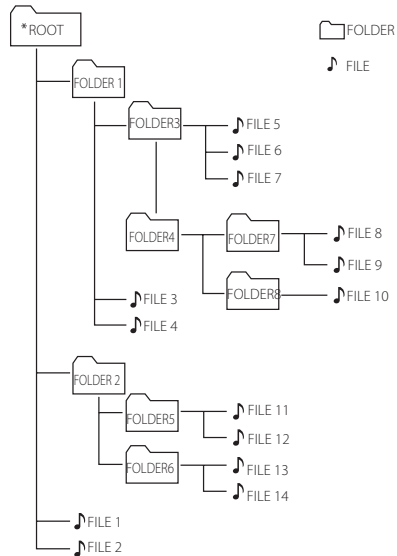

- If there is no file in a folder, the folder will not appear
- Folders will be presented as the following order;  
ROOT → FOLDER1 → FOLDER3 → FOLDER7 → FOLDER8 → FOLDER5 → FOLDER6
- File will be played from **♪** file No.1 to **♪** file No.14 one by one.
- Files and folders will be presented in order recorded and may be presented differently according to the record circumstances.
- \*ROOT : the first screen you can see when a computer recognize the USB is "ROOT".
- The DTS is not supported. In case of DTS audio format, audio is not output.

## Other Operation

### Programmed Playback

The program function enables you to store your favourite tracks/files from any disc or USB device.

A program can contain 20 tracks/files.

1. Insert a CD or connect USB and wait for it to be loaded.
2. Press **PROGRAM/MEMORY** on the remote control in stop state.
3. Press **◀◀/▶▶** or **|◀◀/▶▶|** to select a next track/file.
4. Press **PROGRAM/MEMORY** again to save and select a next track/file.
5. Press **▶/||** or **>||** to play the programmed music tracks/files.
6. To clear your selection, press and hold **■ENTER** or **□**.

#### ! Note

The programs are also cleared when the disc or USB device is removed, the unit is powered off or the function is switched to others.

### Deleting an MP3/WMA file

You can delete file, folder or format by pressing **DELETE** on the remote control. This function is supported only in stop state. (USB only)

1. -Select the file you want to delete by using **◀◀/▶▶** or **|◀◀/▶▶|**. And press **DELETE**.

-Select the folder you want to delete by pressing **PRESET FOLDER ▲/▼** on the remote control. Then press **DELETE**.

-Press and hold **DELETE** to format the USB device.

Or

Press **DELETE** repeatedly while searching a file.

The display window will be changed in the following order.

- DEL FILE? : Deletes file
- DEL FOLDER : Deletes folder
- FORMAT? : Formats USB

2. To delete file/folder or format, press **▶/||** or **>||**.
3. If you want to exit the current mode, press **■ENTER** or **□**.

#### ! Caution

- Do not extract the USB device during operation. (play, delete, etc.)
- Regular back up is recommended to prevent data loss.
- The delete function may not be supported according to the USB state. (lock, etc.)

## Displaying file information

While playing an MP3 file containing file information, you can display the information by pressing **INFO** on the remote control.

## Turn off the sound temporarily

Press **MUTE**  on the remote control to mute your sound.

You can mute the sound in order, for example, to answer the telephone. the mute symbol "M" will appear in the display window. To cancel mute function, press **MUTE**  again or adjust volume level by pressing **VOL+/-**.

## DEMO

In power off state, press **SET/DEMO** on the unit once. The unit will power on and display the each of functions in the display window. To cancel DEMO function, press **SET/DEMO** again.

## Auto Power Down

This unit will be off itself to save electronic consumption in the case main unit is not connected to external device and is not used for 25 minutes. So does this unit after 6 hours since Main unit has been connected to other device using analog input.

# Radio Operations

## Listening to the radio

1. Press **FUNCTION** or **FUNC.** until FM appears in the display window.  
The last received station is tuned in.
2. Auto tuning : Press and hold **TUNING-/+** on the remote control for about 2 seconds until the frequency indication starts changing, then release. Scanning stops when the unit tunes in a station.  
Manual tuning : Press **TUNING-/+** repeatedly.
3. Adjust the volume by pressing **VOL+/-**.

## Improving poor FM reception

Press **▶/||** or **>||**. This will change the tuner from stereo to mono. Then the reception will be better than before.

## Presetting the Radio Stations

You can preset 50 stations for FM. Before tuning, make sure to turn down the volume.

1. Press **FUNCTION** or **FUNC.** until FM appears in the display window.
2. Select the desired frequency by pressing **TUNING-/+**.
3. Press **PROGRAM/MEMORY** on the remote control. A preset number will blink in the display window.
4. Press **PRESETFOLDER ^/V** on the remote control to select the preset number you want.
5. Press **PROGRAM/MEMORY**. The station is stored.
6. Repeat steps 2 to 5 to store other stations.
7. To listen a preset station, press **PRESETFOLDER ^/V**.

## Deleting all the saved stations

1. Press and hold **PROGRAM/MEMORY** on the remote control for two seconds. "ERASE ALL" will blink on the display window.
2. Press **PROGRAM/MEMORY** to erase all saved radio stations.

## Sound adjustment

### Setting the sound mode

This system has a number of pre-set sound fields. You can select a desired sound mode by using **SOUND EFFECT** or **EQ**.

The displayed items for the Equalizer may be different depending on sound sources and effects.

On Display	Description
NATURAL	You can enjoy comfortable and natural sound.
AUTO EQ	Sets the sound equalizer on the mode that is the most similar to the genre which is included in the MP3 ID3 tag of song files.
POP CLASSIC JAZZ ROCK	This program lends an enthusiastic atmosphere to the sound, giving you the feeling you are at an actual rock, pop, jazz or classic concert.
MP3 -- OPT	This function is optimized for compressible MP3 file. It improves the treble sound.
BASS BLAST (BASS)	Reinforces the treble, bass and surround sound effect.
LOUDNESS	Improves the bass and treble sound.
BYPASS	You can enjoy the sound without equalizer effect.

### Note

Maybe you need to reset the sound mode, after switching the input, sometimes even after the sound track/file is changed.

## Setting the Clock

You have two ways to set the clock.

- **Setting the clock by connecting the BT.App.**

Set time you desired on Bluetooth device and connect the Bluetooth device to your unit via BT app. Then the clock setting in the display window will be synchronized with the Bluetooth device automatically.

- **Setting the clock by pressing the buttons.**

1. Turn the unit on.
2. Press and hold **CLOCK**.
3. Choose time mode by pressing **◀◀/▶▶**.  
- 12:00 (for an AM and PM display) or 0:00 (for a 24 hour display)
4. Press **SET** or **SET/DEMO** to confirm your selection.
5. Select the hours by pressing **◀◀/▶▶**.
6. Press **SET** or **SET/DEMO**.
7. Select the minutes by pressing **◀◀/▶▶**.
8. Press **SET** or **SET/DEMO**.
9. If you want to reset the clock, press and hold **CLOCK**. Then repeat steps 3-8.

## Using your player as an alarm clock

1. Turn the unit on.
2. Press and hold **TIMER** on the remote control to set the alarm function.
3. Alarm sound sources will blink. While each of sound sources blink, select the one you want by pressing **SET** or **SET/DEMO**.
4. "ON TIME" will blink. This is your desired time to turns unit on. Press **◀◀/▶▶** to change the hours and minutes and press **SET** or **SET/DEMO** to save.
5. "OFF TIME" will blink. This is your desired time to turn unit off. Press **◀◀/▶▶** to change the hours and minutes and press **SET** or **SET/DEMO** to save.
6. The volume setting will blink. Press **◀◀/▶▶** to change the volume and press **SET** or **SET/DEMO** to save.
7. Press **TIMER** to check the alarm information.
8. If you want to reset the clock, press and hold **TIMER**. Then repeat step 3-6.

### ! Note

- If you unplug the cord from an outlet, the clock setting you set won't be stored.
- If you synchronize the unit with your BT device for clock by using BT app, you can set 12 - Hour Time (ex - PM 11 : 00) or 24 - Hour Time (ex - 23 : 00). (Android O/S only)
- If you set the clock, you can check the time by pressing **CLOCK** although the unit is turned off.
- If you set the clock and alarm, you can check setting information by pressing **TIMER** although the unit is turned off. Then this function will work in everyday.
- Alarm function only works when the unit is turned off.
- When the alarm rings, you can deactivate the alarm by pressing **⏻/⏸** or **⏹**.

## Sleep Timer Setting

Press **SLEEP** repeatedly to select delay time between 10 and 180 minutes. After delay time, the unit will turn off. (You can see the following order, 180 -> 150 -> 120 -> 90 -> 80 -> 70 -> 60 -> 50 -> 40 -> 30 -> 20 -> 10)

To cancel the sleep function, press **SLEEP** repeatedly until the display window get bright.

### Note

- Press **SLEEP**. The remaining time appears in the display window.
- Sleep function will work after dimmer function.

## Dimmer

Press **SLEEP** once. The display window will be darkened by half. To cancel it, press **SLEEP** repeatedly until the display window get bright.

## Using a Bluetooth wireless technology

### About Bluetooth

**Bluetooth**® is wireless communication technology for short range connection.

The available range is within 10 meters.

(The sound may be interrupted when the connection is interfered by the other electronic wave or you connect the bluetooth in the other rooms.)

Connecting individual devices under **Bluetooth**® wireless technology does not incur any charges. A mobile phone with **Bluetooth**® wireless technology can be operated via the Cascade if the connection was made via **Bluetooth**® wireless technology.

Available Devices : Mobile phone, MP3, Laptop, PDA.

### Bluetooth Profiles

In order to use Bluetooth wireless technology, devices must be able to interpret certain profiles. This unit is compatible with following profile.

A2DP (Advanced Audio Distribution Profile)

## Listening to music of a Bluetooth device

Before you start the pairing procedure, make sure the Bluetooth feature is turned on in to your Bluetooth device. Refer to your Bluetooth device's user guide. Once a pairing operation is performed, it does not need to be performed again.

1. Select the Bluetooth function by using the **FUNCTION** on the remote control or **FUNC.** on the unit. "BT READY" appears in the display window.
2. Operate the Bluetooth device and perform the pairing operation. When searching for this unit with the Bluetooth device, a list of the devices found may appear in the Bluetooth device display depending on the type of Bluetooth device. Your unit displays as "LG MICRO(XX:XX)".

### ! Note

XX:XX means the last four digits of BT address. For example, if your unit has a BT address such as 9C:02:98:4A:F7:08, you will see "LG MICRO (F7:08)" on your Bluetooth device.

3. Enter the PIN code.  
PIN code : 0000
4. When this unit is successfully paired with your Bluetooth device, "BT CONN" and "BT PAIR" appears in the display window.

### ! Note

Depending on the Bluetooth device type, some devices have a different pairing way.

5. Listening to music.  
To play a music stored on your Bluetooth device, refer to your Bluetooth device's user guide. According to your Bluetooth device's volume level, the volume level of Bluetooth will be adjusted.

### ! Note

- Sound from the main set can be distorted if you raise the volume of Bluetooth device up to two-thirds or more.
- When you use the Bluetooth function, adjust the volume of a Bluetooth device to a proper level to listen to.

### ! Note

- After searching for this unit on your Bluetooth device, connect the Bluetooth device with this unit. Then play the file you want.
- The sound may be interrupted when the connection interfered by the other electronic wave.
- You cannot control the Bluetooth device with this unit.
- Pairing is limited one Bluetooth device per one unit and multi-pairing is not supported.
- Although the distance between your Bluetooth and the set is less than 10m, if there are obstacles between both, your Bluetooth device cannot be connected.
- Depending on the type of the device, you may not be able to use the Bluetooth function.
- You can enjoy wireless system using phone, MP3, Notebook, etc..
- When not connected the Bluetooth, "BT READY" appears in the display window.
- The Electrical malfunction due to devices using same frequency such as Medical equipment, Microwaves or wireless LAN devices, the connection will be disconnected.
- When someone stands and interrupts communication between Bluetooth device and the player, the connection will be disconnected.
- If the gotten away of the distance between Bluetooth and the unit, the sound quality is lower and lower. The connection will be disconnected when the space between the Bluetooth and the unit gets out of the operating range of Bluetooth.
- The device with Bluetooth wireless technology is disconnected, if you turn off the main unit or put the device away from the main unit more than 10m.
- If the Bluetooth device is disconnected, you should connect the Bluetooth device to your unit.

# Using LG Bluetooth Remote app

## About LG Bluetooth Remote app

LG Bluetooth Remote app bring a suite of new features to your unit. To enjoy more features, you are recommended to download and install free "LG Bluetooth Remote".

## Install " LG Bluetooth Remote app" through " Apple App Store" or "Google Android Market"

1. Tap the Apple App Store icon or Google Android Market(Google Play Store) icon.
2. In the search bar, type in the "LG Bluetooth Remote" and search it.
3. In the search result list, find and tap "LG Bluetooth Remote" to start downloading Bluetooth app.
4. Tap an icon for installation.
5. Tap an icon for downloading.

### ! Note

- Make sure that your powered Bluetooth device is connected to the Internet.
- Make sure that your powered Bluetooth device is equipped with " Apple App Store" or "Google Android Market(Google Play Store)"

## Install " LG Bluetooth Remote app " by using QR code

1. Install " LG Bluetooth Remote app" by using QR code. Use the scanning software to scan the QR code.
2. Tap an icon for installation.
3. Tap an icon for downloading.



(Apple iOS)



(Android OS)

### ! Note

- Make sure that your powered Bluetooth device is connected to the Internet.
- Make sure that your powered Bluetooth device has a scanning software application. If you don't have one, download one from "Google Android Market(Google Play Store)" or "Apple App Store"

## Activate Bluetooth with LG Bluetooth Remote app

LG Bluetooth Remote app helps to connect your powered Bluetooth device to the unit.

1. Tap LG Bluetooth Remote app icon on the home screen to open LG Bluetooth Remote app application, and go to the main menu.
2. Tap [Setting] and select the unit you want.
3. If you want to get more information to operate, tap [Setting] and [Help].

**! Note**

- BT app will be available in the software version as follow;  
Android O/S : 2.3.3(or late)  
iOS O/S : 4.3(or late)
- While using Bluetooth, you may not operate BT app. Disconnect Bluetooth device you have connected before to use BT app properly.
- If you use BT app for operation, there would be some differences between BT app and the supplied remote control. Use the supplied remote control as necessary.
- If you operate BT app with Bluetooth device connected, the Bluetooth connection you have connected before may be disconnected. (Depending on the smartpone's O/S, this process has a difference.)
- Depending on the Bluetooth device, BT.app may not work.
- In Bluetooth function, if you use BT app, the supplied remote control may not work.
- When using BT app for remote control, the operation may differ from the supplied remote control.
- According to the smartphone's operating system, you have some differences for BT app's operation.
- When your Bluetooth device have been already connected with other unit, disconnect the Bluetooth connection first. Then you can control your player through BT app.
- The connection you've made may be disconnected if you select other application or change the setting of the connected device via BT app.In such case, please check the connection status.
- After connection of BT app, music may be output from your device. In this case, try connecting procedure again.

# Troubleshooting

Problem	Correction
No Power.	<ul style="list-style-type: none"> <li>• Plug in the power cord.</li> <li>• Check the condition by operating other electronic devices.</li> </ul>
No sound.	Press <b>FUNCTION</b> or <b>FUNC.</b> and check the selected function.
The unit does not start playback.	<ul style="list-style-type: none"> <li>• Insert a playable disc.</li> <li>• Clean the disc. (Refer to the 26 page)</li> <li>• Insert the disc with the label or printed side facing upward.</li> </ul>
Radio stations cannot be tuned in properly.	<ul style="list-style-type: none"> <li>• Connect the antenna securely.</li> <li>• Tune to the station manually.</li> <li>• Preset some radio stations, see page 17 for details.</li> </ul>
The remote control does not work properly.	<ul style="list-style-type: none"> <li>• Operate the remote control within about 23 ft (7 m).</li> <li>• Remove the obstacle in the path of the remote control and the unit.</li> <li>• Replace the batteries with new ones.</li> </ul>
Clock is not displayed.	Connect your Bluetooth device to your unit through BT app for time sync.

## Trademarks and Licenses

---



*Bluetooth*® wireless technology is a system which allows radio contact between electronic devices within a max. range of 10 meters.

Connecting individual devices under *Bluetooth*® wireless technology does not incur any charges. A mobile phone with *Bluetooth*® wireless technology can be operated via the Cascade if the connection was made via *Bluetooth*® wireless technology.

The *Bluetooth*® word mark and logos are owned by the *Bluetooth*® SIG, Inc. and any use of such marks by LG Electronics is under license.

Other trademarks and trade names are those of their respective owners.

---

## Specifications

General	
Power supply	Refer to the main label.
Power consumption	Refer to the main label.
Dimensions (W x H x D)	286 x 135 x 293 mm
Net Weight (Approx.)	3.8 kg
Operating temperature	5 °C to 35 °C (41 °F to 95 °F)
Operating humidity	5 % to 90 %
Bus Power Supply	DC 5 V  500 mA

Inputs	
PORT. IN	0.5 Vrms (3.5 mm stereo jack)

Tuner	
FM Tuning Range	87.5 MHz to 108.0 MHz or 87.50 MHz to 108.00 MHz

Amplifier	
Stereo mode	80 W + 80 W
T.H.D	10 %

CD	
Frequency Response	30 to 20000 Hz
Signal-to-noise ratio	80 dB
Dynamic range	80 dB

Speakers	
Type	3 Way 4 Speaker
Impedance	4 Ω
Rated Input Power	80 W
Max. Input Power	160 W
Net Dimensions (WxHxD)	132 x 286 x 304 mm
Net Weight (1EA)	4 kg

- Design and specifications are subject to change without notice.

# Maintenance

## Notes on Discs

### Handling Discs

Never stick paper or tape on the disc.

### Storing Discs

After playing, store the disc in its case. Do not expose the disc to direct sunlight or sources of heat and never leave it in a parked car exposed to direct sunlight.

### Cleaning Discs

Do not use strong solvents such as alcohol, benzene, thinner, commercially available cleaners, or anti-static spray intended for older vinyl records.

## Handling the Unit

### When shipping the unit

Please save the original shipping carton and packing materials. If you need to ship the unit, for maximum protection, re-pack the unit as it was originally packed at the factory.

### Keeping the exterior surfaces clean

Do not use volatile liquids such as insecticide spray near the unit.

Wiping with strong pressure may damage the surface.

Do not leave rubber or plastic products in contact with the unit for a long period of time.

### Cleaning the unit

To clean the player, use a soft, dry cloth. If the surfaces are extremely dirty, use a soft cloth lightly moistened with a mild detergent solution. Do not use strong solvents such as alcohol, benzene, or thinner, as these might damage the surface of the unit.

### Maintaining the Unit

The unit is a high-tech, precision device. If the optical pick-up lens and disc drive parts are dirty or worn, the picture quality could be diminished. For details, please contact your nearest authorized service center.



	Телефон	Режим работы	Интернет
Россия	8-800-200-7676	Круглосуточно	<a href="http://www.lg.com">http://www.lg.com</a>
Беларусь	8-820-0071-1111		
Латвия	8-0200-201	9:00 - 17:00 (Пн.-Пт.)	
Литва	8-800-08-081		
Эстония	800-9990		
Украина	0-800-303-000	8:00 - 21:00 (Пн.-Пят.) 8:30 - 18:30 (Суб., Вс.)	
Казахстан	8-8000-805-805	9:00-20:00 (Пн.-Пят.)	
	2255 (GSM)	9:00-18:00 (Суб., Вс.)	
Узбекистан	8 800 120 2222	9:00 - 18:30 (Пн.- Пят.) 9:00 - 15:00 (Суб., Вс.)	
Кыргызстан	800 0071 0005	Круглосуточно	
Молдова	00-800-0071-0005 (Только для стационарных телефонов)	Круглосуточно	

### Україна

Найменування та адреса імпортера :

ПІІ 'ЛГ Електронікс Україна', Україна, 01004, м. Київ, вул. Басейна, 4 (літера А),

тел.: +38 (044) 201-43-50, факс: +38 (044) 201-43-73

### Российская Федерация

Импортер ООО "ЛГ Электроникс Рус"

Адрес импортера : 143160 Российская Федерация, Московская область, Рузский район, сельское поселение Дороховское, 86 км. Минского шоссе, д.9

Адрес производителя : ЛГ Электроникс (Хужоу) Инк., завод Хатаи, 516006, Китай, пров. ГуанДонг, г.

Хужоу, Промышленная зона Жонгкай, Индустриальный парк Хутаи, ХуФенг Донг Уи Роуд, 13.

Сделано в Китае

### Қазақстан Республикасы

Импорттаушы АҚ "ЭЛ Джи Электроникс Алматы Қазақстан", 050061, Алматы қ., к. Кокорай, 2А

Өндірушінің мекенжайы : 516006, Қытай, ГуанДонг ауданы, Хужоу қаласы, Жонгкай өнеркәсіптік аймағы, Хутай Индустриялық саябағы, ХуФенг Донг Уи Роуд, 13.

Қазақстан Республикасы территориясында тұтынушылардан келіп түскен талаптар мен ұсыныстарды қарайтын және тауарды жөндеу мен техникалық қызмет көрсететін ұжым:

АҚ «Эл Джи Электроникс Алматы Қазақстан», 050061, Қазақстан Республикасы, Алматы қ., Кокорай, 2А. Басқа сервис орталықтары жайында мағлұматты "Тұтынушыға қызмет көрсету орталығына" телефон шалу арқылы білуге болады.

Қытайда жасалған