



OWNER'S MANUAL

LED TV*

* LG LED TV applies LCD screen with LED backlights.

Please read this manual carefully before operating your set and retain it for future reference.

55LA9650

65LA9650



P/NO : MFL67652643 (1403-REV03)

www.lg.com

IMPORTANT SAFETY INSTRUCTIONS

Always comply with the following precautions to avoid dangerous situations and ensure peak performance of your product.



WARNING/CAUTION
RISK OF ELECTRIC SHOCK
DO NOT OPEN



TO REDUCE THE RISK OF ELECTRIC SHOCK DO NOT REMOVE COVER (OR BACK). NO USER SERVICEABLE PARTS INSIDE. REFER TO QUALIFIED SERVICE PERSONNEL.



The lightning flash with arrowhead symbol, within an equilateral triangle, is intended to alert the user to the presence of uninsulated "dangerous voltage" within the product's enclosure that may be of sufficient magnitude to constitute a risk of electric shock to persons.



The exclamation point within an equilateral triangle is intended to alert the user to the presence of important operating and maintenance (servicing) instructions in the literature accompanying the appliance.

WARNING/CAUTION

- TO REDUCE THE RISK OF FIRE AND ELECTRIC SHOCK, DO NOT EXPOSE THIS PRODUCT TO RAIN OR MOISTURE.



WARNING

If you ignore the warning message, you may be seriously injured or there is a possibility of accident or death.



CAUTION

If you ignore the caution message, you may be slightly injured or the product may be damaged.



NOTE

The note helps you understand and use the product safely. Please read the note carefully before using the product.

Read these instructions.

Keep these instructions.

Heed all warnings.

Follow all instructions.



- Do not use this apparatus near water.



- Clean only with a dry cloth.



- Do not block any ventilation openings. Install in accordance with the manufacturer's instructions.



- Do not install near any heat sources such as radiators, heat registers, stoves, or other apparatus (including amplifiers) that produce heat.



- Do not defeat the safety purpose of the polarized or grounding-type plug. A polarized plug has two blades with one wider than the other. A grounding type plug has two blades and a third grounding prong. The wide blade or the third prong are provided for your safety. If the provided plug does not fit into your outlet, consult an electrician for replacement of the obsolete outlet (Can differ by country).



- Do not press strongly upon the panel with a hand or a sharp object such as a nail, pencil or pen, or make a scratch on it.



- Protect the power cord from being walked on or pinched particularly at plugs, convenience receptacles, and the point where they exit from the apparatus.



- Only use attachments/accessories specified by the manufacturer.



- Use only with a cart, stand, tripod, bracket, or table specified by the manufacturer, or sold with the apparatus. When a cart is used, use caution when moving the cart/apparatus combination to avoid injury from tip-over.



- Unplug this apparatus during lightning storms or when unused for long periods of time.

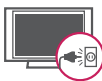

- Refer all servicing to qualified service personnel. Servicing is required when the apparatus has been damaged in any way, such as power-supply cord or plug is damaged, liquid has been spilled or objects have fallen into the apparatus, the apparatus has been exposed to rain or moisture, does not operate normally, or has been dropped.



- Do not stick metal objects or any other conductive material into the power cord. Do not touch the end of the power cord while it is plugged in.

- Keep the packing anti-moisture material or vinyl packing out of the reach of children. Anti-moisture material is harmful if swallowed. If swallowed by mistake, force the patient to vomit and visit the nearest hospital. Additionally, vinyl packing can cause suffocation. Keep it out of the reach of children.

- CAUTION** concerning the Power Cord (Can differ by country):
It is recommended that appliances be placed upon a dedicated circuit; that is, a single outlet circuit which powers only that appliance and has no additional outlets or branch circuits. Check the specification page of this owner's manual to be certain. Do not connect too many appliances to the same AC power outlet as this could result in fire or electric shock. Do not overload wall outlets. Overloaded wall outlets, loose or damaged wall outlets, extension cords, frayed power cords, or damaged or cracked wire insulation are dangerous. Any of these conditions could result in electric shock or fire. Periodically examine the cord of your appliance, and if its appearance indicates damage or deterioration, unplug it, discontinue use of the appliance, and have the cord replaced with an exact replacement part by an authorized service. Protect the power cord from physical or mechanical abuse, such as being twisted, kinked, pinched, closed in a door, or walked upon. Pay particular attention to plugs, wall outlets, and the point where the cord exits the appliance. Do not move the TV with the power cord plugged in. Do not use a damaged or loose power cord. Be sure do grasp the plug when unplugging the power cord. Do not pull on the power cord to unplug the TV.



- Warning** - To reduce the risk of fire or electrical shock, do not expose this product to rain, moisture or other liquids. Do not touch the TV with wet hands. Do not install this product near flammable objects such as gasoline or candles, or expose the TV to direct air conditioning.



- Do not expose to dripping or splashing and do not place objects filled with liquids, such as vases, cups, etc. on or over the apparatus (e.g. on shelves above the unit).



Grounding

(Except for devices which are not grounded.) Ensure that you connect the earth ground wire to prevent possible electric shock (i.e. a TV with a three-prong grounded AC plug must be connected to a three-prong grounded AC outlet). If grounding methods are not possible, have a qualified electrician install a separate circuit breaker. Do not try to ground the unit by connecting it to telephone wires, lightning rods, or gas pipes.

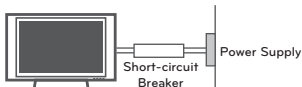

- As long as this unit is connected to the AC wall outlet, it is not disconnected from the AC power source even if the unit is turned off.
- Do not attempt to modify this product in any way without written authorization from LG Electronics. Unauthorized modification could void the user's authority to operate this product.
- Outdoor Antenna Grounding**
(Can differ by country):
If an outdoor antenna is installed, follow the precautions below. An outdoor antenna system should not be located in the vicinity of overhead power lines or other electric light or power circuits, or where it can come in contact with such power lines or circuits as death or serious injury can occur. Be sure the antenna system is grounded to provide some protection against voltage surges and built-up static charges. Section 810 of the National Electrical Code (NEC) in the U.S.A. provides information with respect to proper grounding of the mast and supporting structure, grounding of the lead-in wire to an antenna discharge unit, size of grounding conductors, location of antenna discharge unit, connection to grounding electrodes and requirements for the grounding electrode.

Antenna grounding according to the National Electrical Code, ANSI/NFPA 70

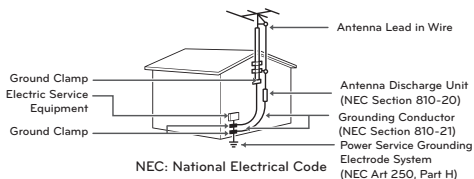

Cleaning

When cleaning, unplug the power cord and wipe gently with a soft cloth to prevent scratching. Do not spray water or other liquids directly on the TV as electric shock may occur. Do not clean with chemicals such as alcohol, thinners, or benzene.

Moving

Make sure the product is turned off, unplugged, and all cables have been removed. It may take 2 or more people to carry larger TVs. Do not press or put stress on the front panel of the TV.

Ventilation

Install your TV where there is proper ventilation. Do not install in a confined space such as a bookcase. Do not cover the product with cloth or other materials while plugged. Do not install in excessively dusty places.

- If you smell smoke or other odors coming from the TV, unplug the power cord and contact an authorized service center.
- Keep the product away from direct sunlight.
- Never touch this apparatus or antenna during a thunder or lightning storm.
- When mounting a TV on the wall, make sure not to install the TV by hanging the power and signal cables on the back of the TV.
- Do not allow an impact shock or any objects to fall into the product, and do not drop anything onto the screen.
- Disconnecting the Main Power**
The power outlet used with this device must remain easily accessible.
- Store the accessories (battery, etc.) in a safe location out of the reach of children.
- This apparatus use batteries. In your community there might be regulations that require you to dispose of these batteries properly due to environmental considerations. Please contact your local authorities for disposal or recycling information.
- Do not dispose of batteries in a fire.
- Do not short circuit, disassemble, or allow the batteries to overheat.

- **Dot Defect**

The Plasma or LCD panel is a high technology product with resolution of two million to six million pixels.

In a very few cases, you could see fine dots on the screen while you're viewing the TV. Those dots are deactivated pixels and do not affect the performance and reliability of the TV.

- **Generated Sound**

Cracking noise: A cracking noise that occurs when watching or turning off the TV is generated by plastic thermal contraction due to temperature and humidity. This noise is common for products where thermal deformation is required.

Electrical circuit humming/panel buzzing: A low level noise is generated from a high-speed switching circuit, which supplies a large amount of current to operate a product. It varies depending upon the product.

This generated sound does not affect the performance and reliability of the product.

- Take care not to touch the ventilation openings.

When watching the TV for a long period, the ventilation openings may become hot. This does not affect the performance of the product or cause defects in the product.

- If the TV feels cold to the touch, there may be a small flicker when it is turned on. This is normal, there is nothing wrong with TV. Some minute dot defects may be visible on the screen, appearing as tiny red, green, or blue spots. However, they have no adverse effect on the TV's performance. Avoid touching the LCD screen or holding your finger(s) against it for long periods of time. Doing so may produce some temporary distortion effects on the screen.

Preventing Image burn or Burn-in on your TV screen

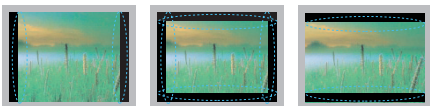

- If a fixed image displays on the TV screen for a long period of time, it will be imprinted and become a permanent disfigurement on the screen. This is image burn or burn-in and not covered by the warranty.
- If the aspect ratio of the TV is set to 4:3 for a long period of time, image burn may occur on the letterboxed area of the screen.
- Avoid displaying a fixed image on the TV screen for a long period of time (2 or more hours for LCD, 1 or more hours for the Plasma TV) to prevent image burn.

For USA and Canada

FCC NOTICE

This equipment has been tested and found to comply with the limits for a Class B digital device, pursuant to Part 15 of the FCC Rules. These limits are designed to provide reasonable protection against harmful interference in a residential installation. This equipment generates, uses and can radiate radio frequency energy and, if not installed and used in accordance with the instructions, may cause harmful interference to radio communications. However, there is no guarantee that interference will not occur in a particular installation. If this equipment does cause harmful interference to radio or television reception, which can be determined by turning the equipment off and on, the user is encouraged to try to correct the interference by one or more of the following measures:

- Reorient or relocate the receiving antenna.
- Increase the separation between the equipment and the receiver.
- Connect the equipment to an outlet on a circuit different from that to which the receiver is connected.
- Consult the dealer or an experienced radio/TV technician for help.

This device complies with part 15 of the FCC Rules. Operation is subject to the following two conditions: (1) this device may not cause harmful interference and (2) this device must accept any interference received, including interference that may cause undesired operation of the device. Any changes or modifications in construction of this device which are not expressly approved by the party responsible for compliance could void the user's authority to operate the equipment.

NOTE TO CABLE/TV INSTALLER

This reminder is provided to call the CATV system installer's attention to Article 820-40 of the National Electric Code (U.S.A.). The code provides guidelines for proper grounding and, in particular, specifies that the cable ground shall be connected to the grounding system of the building, as close to the point of the cable entry as practical.

Viewing 3D Imaging

WARNING

Viewing Environment

- Viewing Time
 - When watching 3D content, take 5 - 15 minute breaks every hour. Viewing 3D content for a long period of time may cause headache, dizziness, fatigue or eye strain.

Those that have a photosensitive seizure or chronic illness

- Some users may experience a seizure or other abnormal symptoms when they are exposed to a flashing light or particular pattern from 3D content.
- Do not watch 3D videos if you feel nauseous, are pregnant and/ or have a chronic illness such as epilepsy, cardiac disorder, or blood pressure disease, etc.
- 3D Content is not recommended for those who suffer from stereo blindness or stereo anomaly. Double images or discomfort in viewing may be experienced.
- If you have strabismus (cross-eyed), amblyopia (weak eyesight) or astigmatism, you may have trouble sensing depth and easily feel fatigue due to double images. It is advised to take more frequent breaks than the average adult.
- If your eyesight varies between your right and left eye, revise your eyesight prior to watching 3D content.

Symptoms which require discontinuation or refraining from watching 3D content

- Do not watch 3D content when you feel fatigue from lack of sleep, overwork, or intoxication.
- When these symptoms are experienced, stop using/watching 3D content and get enough rest until the symptom subsides.
 - Consult your doctor when the symptoms persist. Symptoms may include headache, eyeball pain, dizziness, nausea, palpitation, blurriness, discomfort, double image, visual inconvenience, or fatigue.

CAUTION

Viewing Environment

- Viewing Distance
 - Maintain a distance of at least twice the screen diagonal length when watching 3D content. If you feel discomfort in viewing 3D content, move further away from the TV.

Viewing Age

- Infants / Children
 - Usage/ Viewing 3D content for children under the age of 5 are prohibited.
 - Children under the age of 10 may overreact and become overly excited because their vision is in development (for example: trying to touch the screen or trying to jump into it. Special monitoring and extra attention is required for children watching 3D content.
 - Children have greater binocular disparity of 3D presentations than adults because the distance between the eyes is shorter than one of adults. Therefore they will perceive more stereoscopic depth compared to adults for the same 3D image.
- Teenagers
 - Teenagers under the age of 19 may be stimulated to light coming from 3D videos. Advise them not to watch 3D videos for a long time when they are tired.
- Elderly
 - The elderly may perceive less of a 3D effect than the youth. Do not sit closer to the TV than the recommended distance.

Cautions when using the 3D glasses

- Only use LG 3D glasses. Otherwise, you may not be able to view 3D videos properly.
- Do not use 3D glasses instead of your normal glasses, sunglasses, or protective goggles.
- Using modified 3D glasses may cause eye strain or image distortion.
- Do not keep your 3D glasses in extremely high or low temperatures. It will cause deformation.
- The 3D glasses are fragile and are easy to scratched. Use a soft, clean piece of cloth when wiping the lenses. Do not scratch the lenses of the 3D glasses with sharp objects or clean/wipe them with chemicals.

LICENSES

Supported licenses may differ by model. For more information about licenses, visit www.lg.com.



Manufactured under license from Dolby Laboratories. "Dolby" and the double-D symbol are trademarks of Dolby Laboratories.



The terms HDMI and HDMI High-Definition Multimedia Interface, and the HDMI logo are trademarks or registered trademarks of HDMI Licensing LLC in the United States and other countries.



ABOUT DIVX VIDEO: DivX[®] is a digital video format created by DivX, LLC, a subsidiary of Rovi Corporation. This is an official DivX Certified[®] device that plays DivX video. Visit divx.com for more information and software tools to convert your files into DivX video.

ABOUT DIVX VIDEO-ON-DEMAND: This DivX Certified[®] device must be registered in order to play purchased DivX Video-on-Demand (VOD) movies. To obtain your registration code, locate the DivX VOD section in your device setup menu. Go to vod.divx.com for more information on how to complete your registration.

"DivX Certified[®] to play DivX[®] video up to HD 1080p, including premium content."

"DivX[®], DivX Certified[®] and associated logos are trademarks of Rovi Corporation or its subsidiaries and are used under license."

"Covered by one or more of the following U.S. patents: 7,295,673; 7,460,668; 7,515,710; 7,519,274"



Manufactured under license under U.S. Patent Nos: 5,956,674; 5,974,380; 6,487,535 & other U.S. and worldwide patents issued & pending. DTS, the Symbol & DTS and the Symbol together are registered trademarks & DTS 2.0+Digital Out is a trademark of DTS, Inc. Product includes software. © DTS, Inc. All Rights Reserved.

OPEN SOURCE SOFTWARE NOTICE

To obtain the source code under GPL, LGPL, MPL and other open source licenses, that is contained in this product, please visit <http://opensource.lge.com>.

In addition to the source code, all referred license terms, warranty disclaimers and copyright notices are available for download.

LG Electronics will also provide open source code to you on CD-ROM for a charge covering the cost of performing such distribution (such as the cost of media, shipping and handling) upon email request to opensource@lge.com. This offer is valid for three (3) years from the date on which you purchased the product.

TABLE OF CONTENTS

2 IMPORTANT SAFETY INSTRUCTIONS

6 Viewing 3D Imaging

7 LICENSES

7 OPEN SOURCE SOFTWARE NOTICE

8 TABLE OF CONTENTS

9 INSTALLATION PROCEDURE

9 ASSEMBLING AND PREPARING

- 9 Unpacking
- 11 Optional Extras
- 12 Parts and Buttons
- 13 Lifting and Moving the TV
- 14 Setting up the TV
 - 14 - Attaching the Stand
 - 15 - Mounting on a Table
 - 16 - Tidying cables
 - 16 - Mounting on a Wall

18 MAKING CONNECTIONS

- 18 Connecting to an Antenna or Cable
- 19 Connecting to a HD receiver, DVD Player or VCR
 - 19 - HDMI Connection
 - 20 - DVI to HDMI Connection
 - 21 - Connecting to a Mobile Phone
 - 22 - Component Connection
 - 23 - Composite Connection
- 24 Connecting a PC
 - 24 - HDMI Connection or DVI to HDMI Connection
- 26 Connecting to an Audio System
 - 26 - Digital Optical Audio Connection
- 27 Connecting Headphones
- 28 Connecting a USB Device

29 MAGIC REMOTE CONTROL FUNCTIONS

- 30 Registering Magic Remote Control
- 30 How to use Magic Remote Control
- 30 Precautions to Take when Using the Magic Remote Control

31 WATCHING TV

- 31 Turning the TV on for the First Time

32 USING THE USER GUIDE

33 SPECIFICATIONS

37 EXTERNAL CONTROL DEVICE SETUP

38 MAINTENANCE

- 38 Cleaning Your TV
 - 38 - Screen, Frame, Cabinet, and Stand
 - 38 - Power Cord

38 TROUBLESHOOTING



NOTE

- Image shown may differ from your TV.
- Your TV's OSD (On Screen Display) may differ slightly from that shown in this manual.
- The available menus and options may differ from the input source or product model that you are using.
- New features may be added to this TV in the future.

INSTALLATION PROCEDURE

- 1 Open the package and make sure all the accessories are included.
- 2 Attach the stand to the TV set.
- 3 Connect an external device to the TV set.
- 4 Make sure the network connection is available.
You can use the TV network functions only when the network connection is made.

ASSEMBLING AND PREPARING

Unpacking

Check your product box for the following items. If there are any missing accessories, contact the local dealer where you purchased your product. The illustrations in this manual may differ from the actual product and item.

CAUTION

- Do not use any unapproved items to ensure the safety and product life span.
- Any damages or injuries by using unapproved items are not covered by the warranty.
- Some models appear to have a thin film on the screen. It is actually part of the screen; do not remove it.

NOTE

- The items supplied with your product may vary depending upon the model.
- Product specifications or contents of this manual may be changed without prior notice due to upgrade of product functions.
- For an optimal connection, HDMI cables and USB devices should have bezels less than 10 mm (0.39 inches) thick and 18 mm (0.7 inches) width.
- Use an extension cable that supports USB 2.0 if the USB cable or USB memory stick does not fit into your TV's USB port.

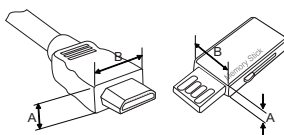

*A  10 mm (0.39 inches)

*B  18 mm (0.7 inches)

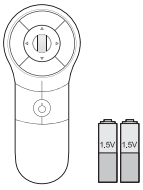

**Magic Remote Control,
Batteries (AA)**
(See page 29.)



Owner's Manual

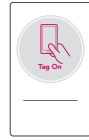

Tag On

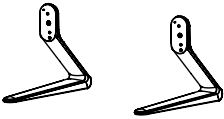

Stand Base
(See page 14.)



Stand Screws
4 EA, M4 x 14
(See page 14.)



Cable Holder
(See page 16.)

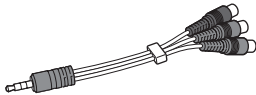

Component Video Cable
(See page 22.)

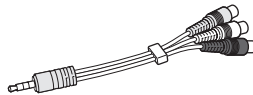

Composite Video Cable
(See page 22, 23.)



Cinema 3D Glasses
The number of 3D glasses
may differ depending upon
the model or country.
(Depending upon model)

Optional Extras

Optional extras can be changed or modified for quality improvement without any notification.

Contact your dealer to buy these items.

These devices only work with certain models.

The model name or design may be changed manufacturer's circumstances or policies.

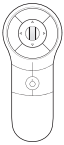

AN-MR400
Magic Remote



AG-F***
Cinema 3D Glasses



AG-F*DP**
Dual Play Glasses

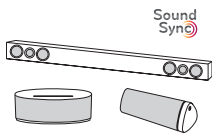

LG Audio Device



Tag On



AN-BL***
Wireless IR Blaster
(Depending upon model)

Parts and Buttons

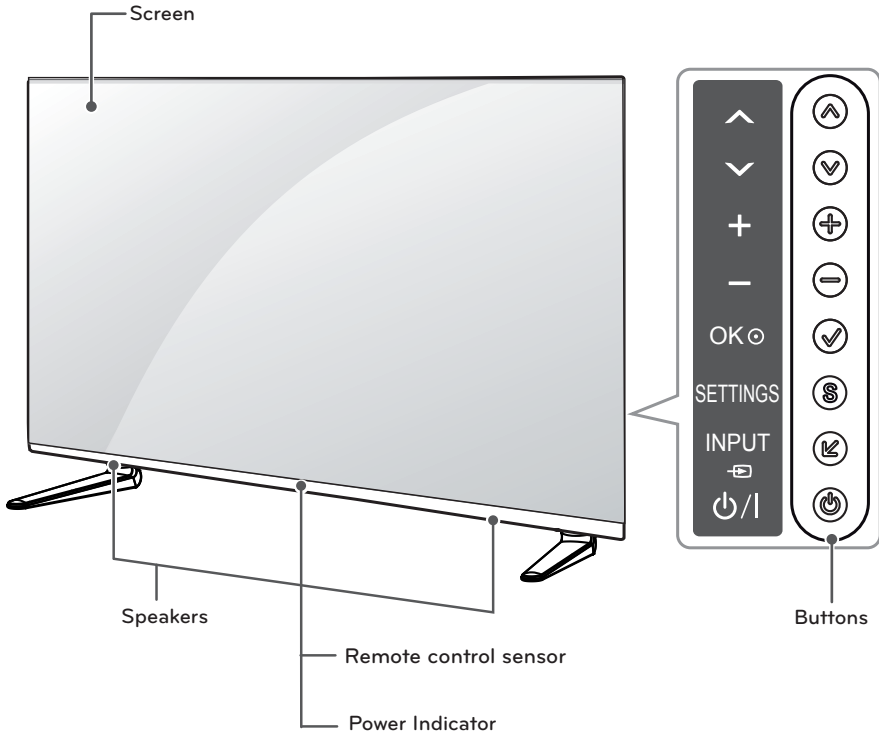

Button	Description
▲/▼ (▲/▼)	Scrolls through the saved channels.
+/- (+/-)	Adjusts the volume level.
✓ (OK ○)	Selects the highlighted menu option or confirms an input.
S (SETTINGS)	Accesses the main menus, or saves your input and exits the menus.
⏏ (INPUT ⏏)	Changes the input source.
⏻/⏼	Turns the power on or off.

⚠ CAUTION

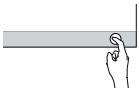

- To avoid possible SPEAKER damage or degradation in performance please keep contact of TV /Speaker out of reach of Children.

Lifting and Moving the TV

When moving or lifting the TV, read the following to prevent the TV from being scratched or damaged and for safe transportation regardless of its type and size.

CAUTION

- Avoid touching the screen at all times, as this may result in damage to the screen.
- Do not place the product on the floor with its front facing down. Doing so may result in damage to the screen.
- It is recommended to move the TV in the box or packing material that the TV originally came in.
- Before moving or lifting the TV, disconnect the power cord and all cables.
- When holding the TV, the screen should face away from you to avoid damage.



- Hold the top and bottom of the TV frame firmly. Make sure not to hold the transparent part, speaker, or speaker grill area.

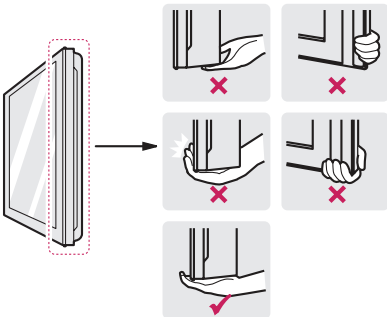

- When transporting a large TV, there should be at least 2 people.
- When transporting the TV by hand, hold the TV as shown in the following illustration.

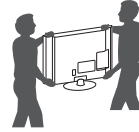

- When transporting the TV, do not expose the TV to jolts or excessive vibration.
- When transporting the TV, keep the TV upright, never turn the TV on its side or tilt towards the left or right.

Setting up the TV

You can mount your TV to a wall or attach the stand if you wish to place the TV on an entertainment center or other furniture.

Attaching the Stand

If you are not mounting the TV to a wall, use the following instructions to attach the stand.

CAUTION

- When attaching the stand to the TV set, place the screen facing down on a cushioned table or flat surface to protect the screen from scratches.
- Make sure that the screws are fastened tightly. (If they are not fastened securely enough, the TV may tilt forward after being installed.)
- Do not tighten the screws with too much force; otherwise they may be damaged and come loose later.

NOTE

- Remove the stand before installing the TV on a wall mount by performing the stand attachment in reverse.

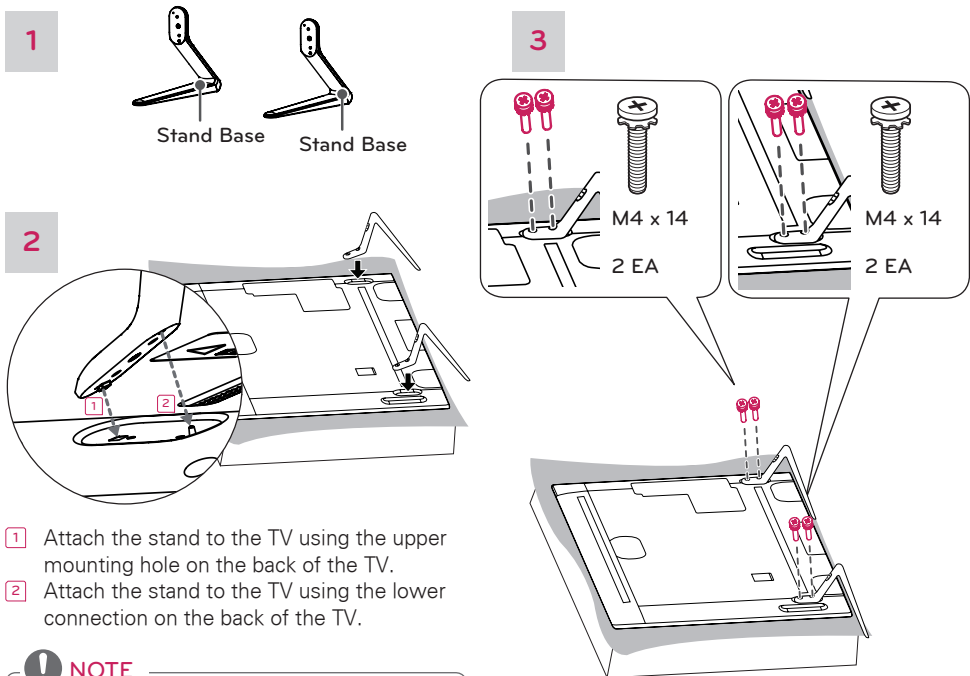

- 1 Attach the stand to the TV using the upper mounting hole on the back of the TV.
- 2 Attach the stand to the TV using the lower connection on the back of the TV.

NOTE

- Be sure to attach the upper mounting hole first, and then attach the lower connection second.

Mounting on a Table

- Lift and tilt the TV into its upright position on a table.
 - Leave a 10 cm (4 inches) (minimum) space from the wall for proper ventilation.

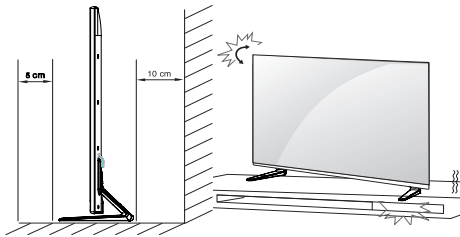
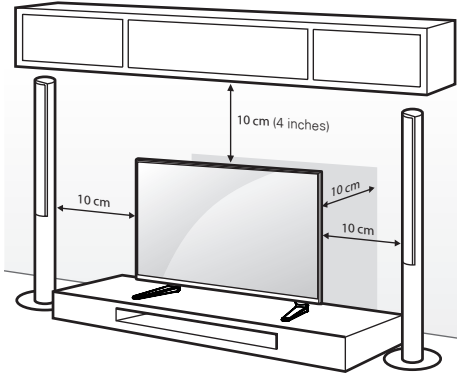

- Connect the power cord to a wall outlet.

CAUTION

- Do not place the TV near or on sources of heat, as this may result in fire or other damage.

Securing the TV to a wall (optional)

(Depending upon model)

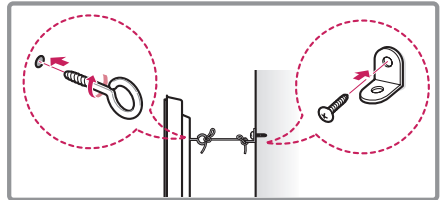
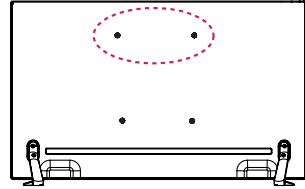

- Insert and tighten the eye-bolts, or TV brackets and bolts on the back of the TV.
 - If there are bolts inserted at the eye-bolts position, remove the bolts first.
- Mount the wall brackets with the bolts to the wall. Match the location of the wall bracket and the eye-bolts on the rear of the TV.
- Connect the eye-bolts and wall brackets tightly with a sturdy rope. Make sure to keep the rope horizontal with the flat surface.

CAUTION

- Make sure that children do not climb on or hang on the TV.

NOTE

- Use a platform or cabinet that is strong and large enough to support the TV securely.
- Brackets, bolts, and ropes are optional. You can obtain additional accessories from your local dealer.

Tidying cables

- 1 Gather and bind the cables with the Cable Management.

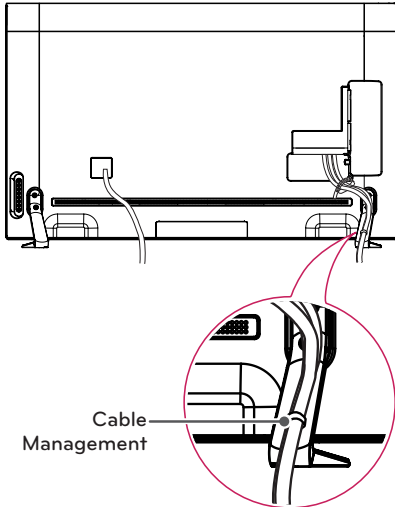

- 2 Gather and bind the cables with the Cable Holder.

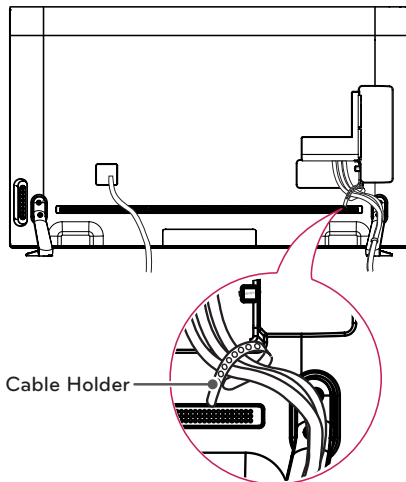

CAUTION

- Do not move the TV by holding the cable holder and cable management, as the cable holders may break, and injuries and damage to the TV may occur.

Mounting on a Wall

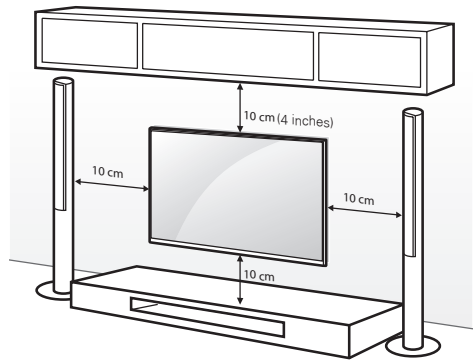

An optional wall mount can be used with your LG Television. Consult with your local dealer for a wall mount that supports the VESA standard used by your TV model. Carefully attach the wall mount bracket at the rear of the TV. Install the wall mount bracket on a solid wall perpendicular to the floor. If you are attaching the TV to other building materials, please contact qualified personnel to install the wall mount. Detailed instructions will be included with the wall mount. We recommend that you use an LG brand wall mount.

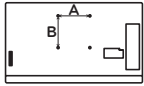

Make sure to use screws and wall mounts that meet the VESA standard. Standard dimensions for the wall mount kits are described in the following table.

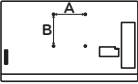
Model	55LA9650
VESA (A x B)	400 x 400
	
Standard screw	M6
Number of screws	4
Wall mount bracket (optional)	LSW430B MSW240

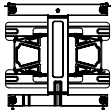
Model	65LA9650
VESA (A x B)	400 x 400
	
Standard screw	M6
Number of screws	4
Wall mount bracket (optional)	LSW430B

Wall mount bracket (optional)	
LSW430B	
MSW240	

NOTE

- Use the screws that are listed in the VESA standard screw specifications.
- The wall mount kit includes an installation manual and necessary parts.
- The wall mount bracket is optional. You can obtain additional accessories from your local dealer.
- The length of screws may differ depending upon the wall mount. Make sure to use the proper length.
- For more information, refer to the manual supplied with the wall mount.

CAUTION

- Disconnect the power before moving or installing the TV. Otherwise electric shock may occur.
- If you install the TV on a ceiling or slanted wall, it may fall and result in severe injury. Use an authorized LG wall mount and contact the local dealer or qualified personnel.
- Do not over tighten the screws as this may cause damage to the TV and void your warranty.
- Use the screws and wall mounts that meet the VESA standard. Any damages or injuries by misuse or using an improper accessory are not covered by the warranty.

MAKING CONNECTIONS

You can connect various external devices to the TV. Supported external devices are: HD receivers, DVD players, VCRs, audio systems, USB storage devices, PC, gaming devices, and other external devices. For more information on external device's connection, refer to the manual provided with each device.

! NOTE

- If you record a TV program on a DVD recorder or VCR, make sure to connect the TV signal input cable to the TV through a DVD recorder or VCR. For more information of recording, refer to the manual provided with the connected device.
- The external device connections shown may differ slightly from illustrations in this manual.
- Connect external devices to the TV regardless of the order of the TV port.
- If you connect a gaming device to the TV, use the cable supplied with the gaming device.
- Refer to the external equipment's manual for operating instructions.

Connecting to an Antenna or Cable

Connect an antenna, cable, or cable box to watch TV while referring to the following. The illustrations may differ from the actual items and a RF cable is optional.

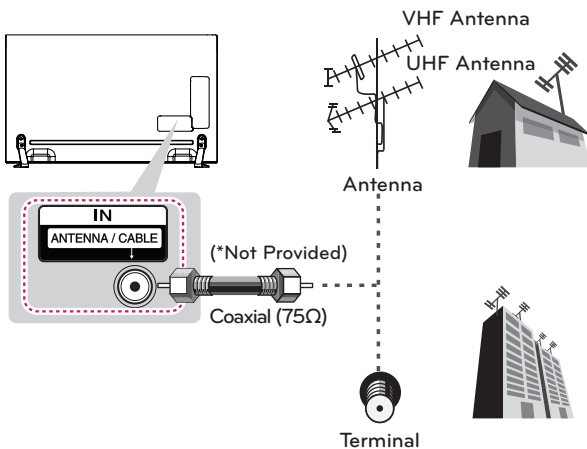

! CAUTION

- Make sure not to bend the copper wire of the RF cable.

Copper wire

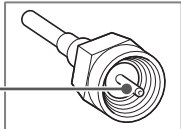

- Complete all connections between devices, and then connect the power cord to the power outlet to prevent damage to your TV.

! NOTE

- Use a signal splitter to use more than 2 TVs.
- DTV Audio Supported Codec: MPEG, Dolby Digital.
- Display of Ultra HD (3840 x 2160 pixels) content compatible; additional device capable of processing Ultra HD source content (in 2D or 3D) may be required and will be sold separately.

Connecting to a HD receiver, DVD Player or VCR

Connect a HD receiver, DVD Player, or VCR to the TV and select an appropriate input mode.

HDMI Connection

HDMI is the best way to connect a device.

Transmits digital video and audio signals from an external device to the TV. Connect the external device and the TV with the HDMI cable as shown in the following illustration.

NOTE

- Use the latest High Speed HDMI™ Cable that supports CEC (Customer Electronics Control) function.
- High Speed HDMI™ Cables are tested to carry an HD signal up to 1080p and higher.
- HDMI Audio Supported Format: PCM (Up to 192 kHz, 32 kHz / 44.1 kHz / 48 kHz / 88 kHz / 96 kHz / 176 kHz / 192 kHz)

Choose any HDMI input port to connect.
It does not matter which port you use.

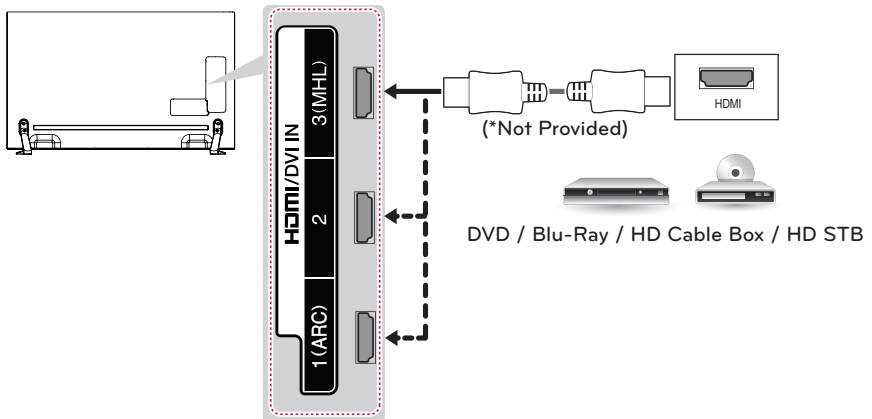

ARC (Audio Return Channel)

- When connected with a high-speed HDMI cable, digital audio can be sent to a compatible device without an additional optical audio cable.
- ARC is only supported on the HDMI/DVI IN 1 (ARC) port. An external audio device that supports ARC should be connected to HDMI/DVI IN 1 if you wish to use ARC.

DVI to HDMI Connection

Transmits the digital video signal from an external device to the TV. Connect the external device and the TV with the DVI-HDMI cable as shown in the following illustration. To transmit an audio signal, connect an audio cable.

! NOTE

- When using the HDMI/DVI cable, Single link only is supported.

Choose any HDMI input port to connect.
It does not matter which port you use.

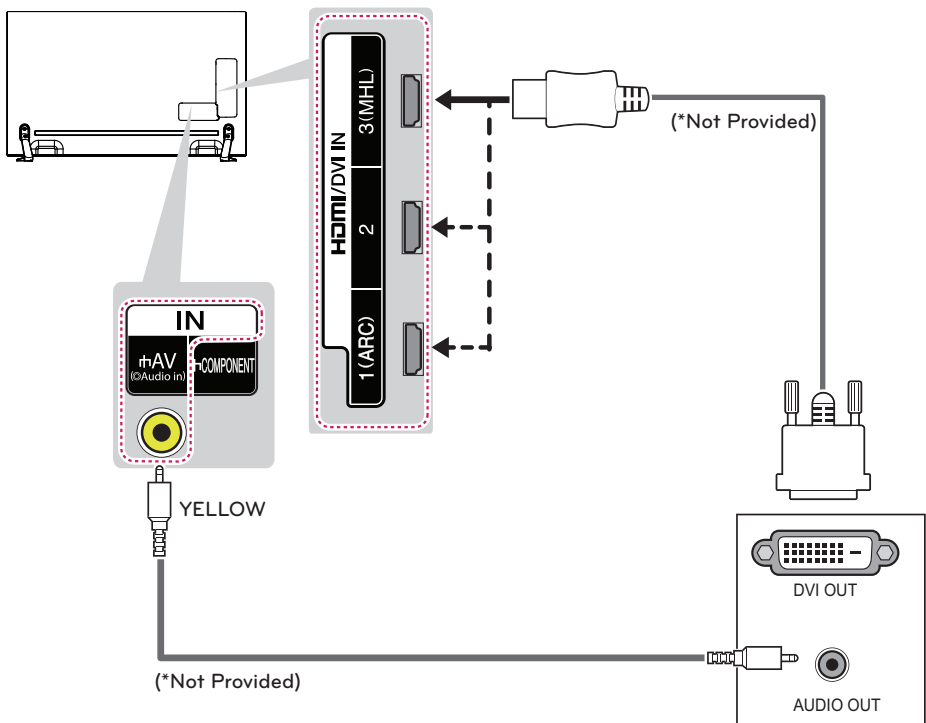

DVD / Blu-Ray / HD Cable Box

Connecting to a Mobile Phone

Mobile High-definition Link (MHL) is an interface for transmitting digital audio/visual signals from mobile phones to television sets.

! NOTE

- Connect the mobile phone to the HDMI/DVI IN 3 (MHL) port to view the phone screen on the TV.
- This only works with an MHL-enabled phone.
- With some MHL supporting mobile phones, you can use the TV remote to control the phone.
- An MHL passive cable is needed to connect the TV and a mobile phone.
- Remove the MHL cable from the TV when:
 - the MHL function is disabled
 - your mobile device is fully charged in standby mode

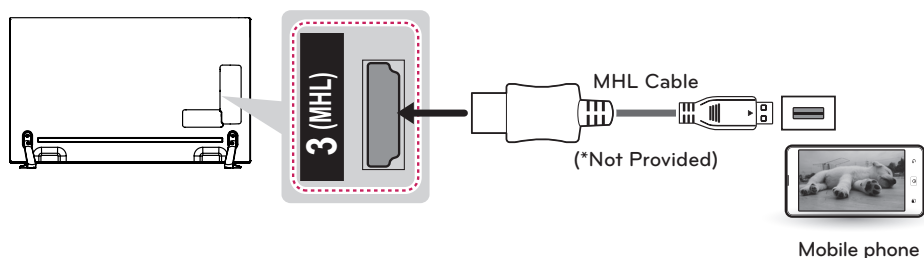

Component Connection

Transmits analog video and audio signals from an external device to the TV. Connect the external device and the TV with a component cable as shown in the following illustration.

NOTE

- If cables are installed incorrectly, it could cause the image to display in black and white or with distorted color.
- Check to ensure the cables are matched with the corresponding color connection.

ENGLISH

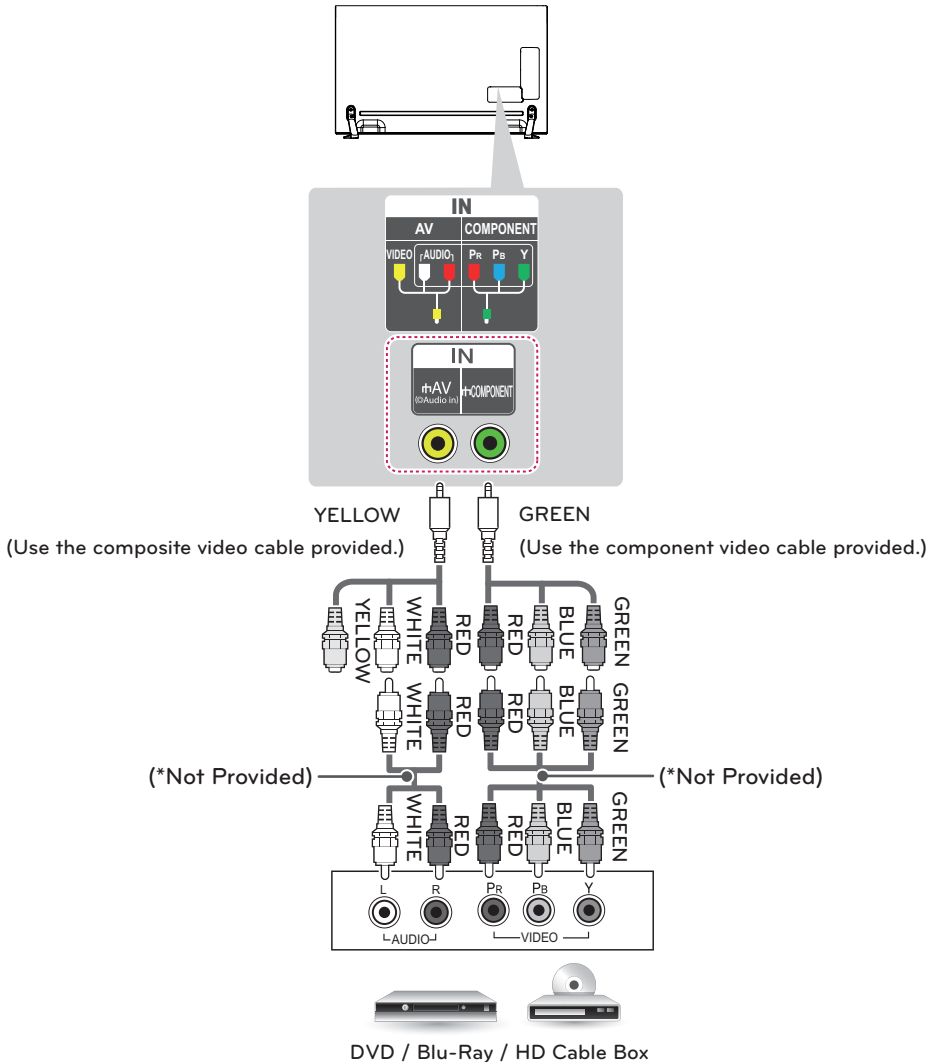

Composite Connection

Transmits analog video and audio signals from an external device to the TV. Connect the external device and the TV with the composite cable as shown in the following illustration.

NOTE

- If you have a mono VCR, connect the audio cable from the VCR to the AUDIO L/MONO jack of the TV.
- Check to ensure the cables are matched with the corresponding color connection.

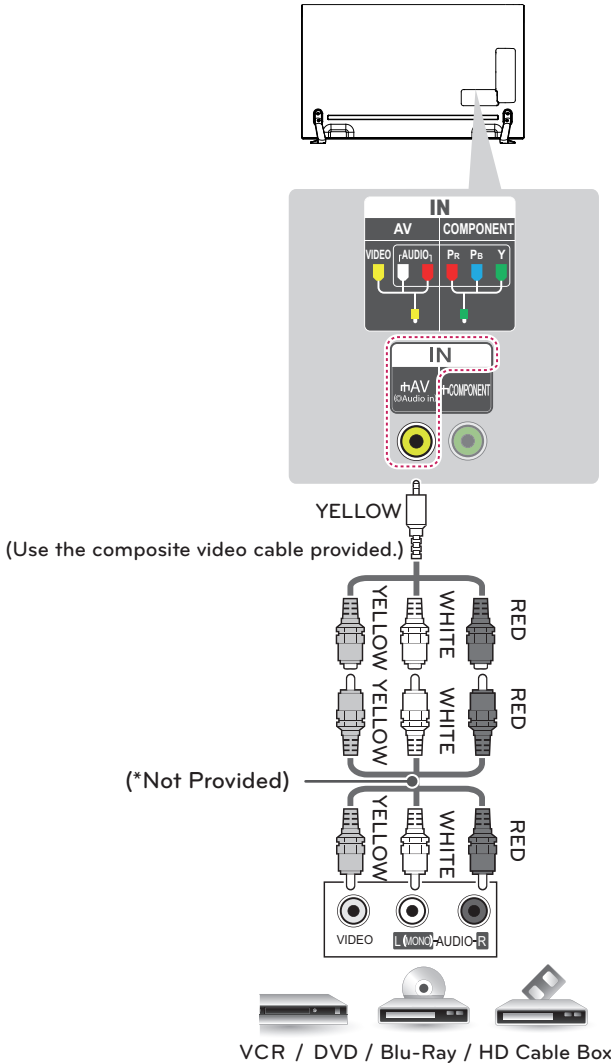

Connecting a PC

! NOTE

- It is recommended to use an HDMI connection for the best image quality.
- Depending upon the graphics card, DOS mode video may not work if a HDMI to DVI Cable is in use.
- In PC mode, there may be noise associated with the resolution, vertical pattern, contrast, or brightness. If noise is present, change the PC output to another resolution, change the refresh rate to another rate or adjust the brightness and contrast on the PICTURE menu until the picture is clear.
- The synchronization input form for Horizontal and Vertical frequencies is separate.
- Depending upon the graphics card, some resolution settings may not allow the image to be positioned on the screen properly.
- If you are using DVI out from a PC, you have to connect analog audio separately. Refer to the instructions on the next page.
- When using the HDMI/DVI cable, Single link is only supported.

HDMI Connection or DVI to HDMI Connection

Choose method A or B to make connection.

Method A: HDMI Connection

Choose any HDMI input port to connect.
It does not matter which port you use.

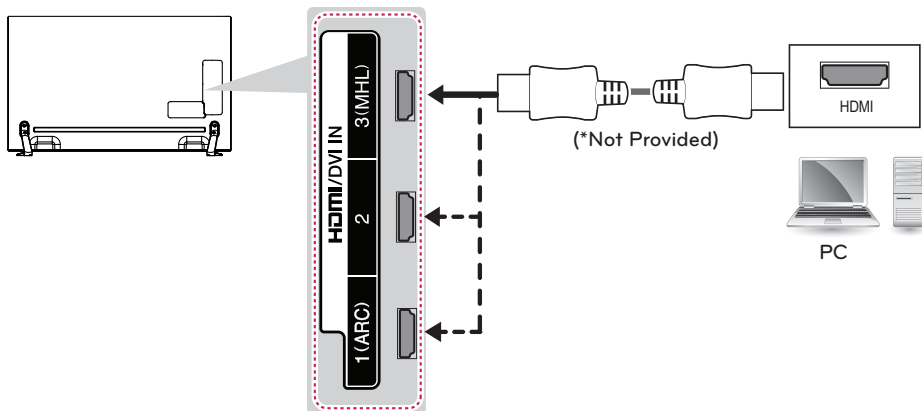

Method B: DVI to HDMI Connection

Choose any HDMI input port to connect.
It does not matter which port you use.

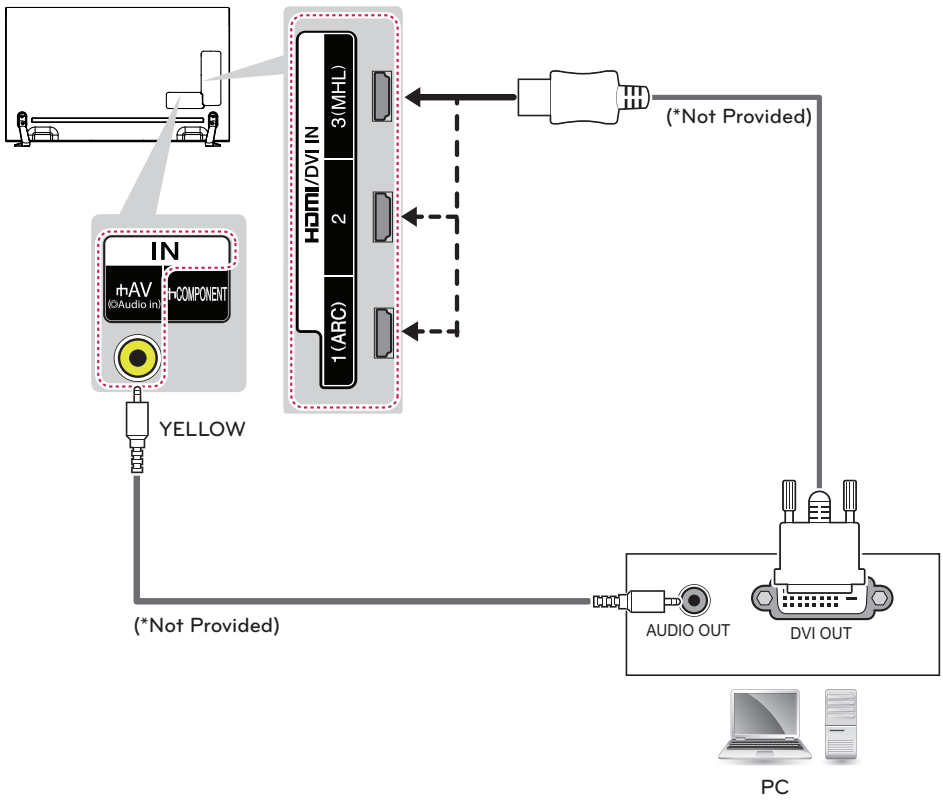

Connecting to an Audio System

You can use an optional external audio system instead of the built-in speaker.

Digital Optical Audio Connection

Transmits a digital audio signal from the TV to an external device. Connect the external device and the TV with the optical audio cable as shown in the following illustration.

! NOTE

- Do not look into the optical output port. Looking at the laser beam may damage your vision.
- Audio with ACP (Audio Copy Protection) function may block digital audio output.

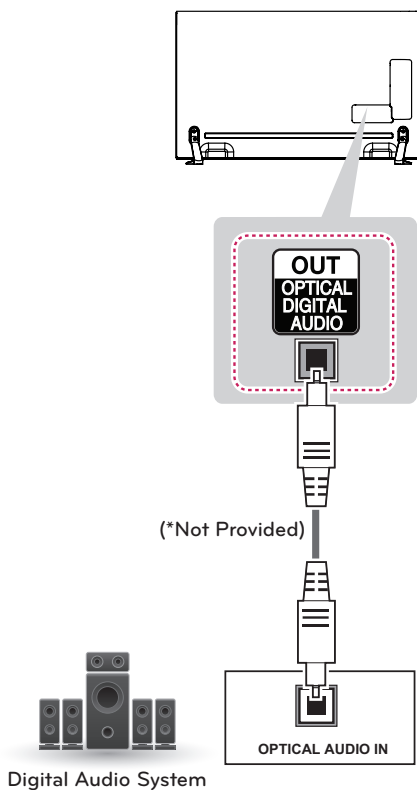

Connecting Headphones

Listening to sound with headphones

! NOTE

- AUDIO menu options are disabled when using headphones.
- When changing AV MODE with headphones connected, the change is applied to video but not to audio.
- Optical Digital Audio Out is not available when headphones are connected.
- Headphone impedance 16 Ω
- Max audio output: 0.6 mW to 1.3 mW
- Headphone jack size: 0.35 cm (0.13 inches)

! CAUTION

- Do not use headsets (earphones) at high volume or for a long time. It may cause damage to your hearing.

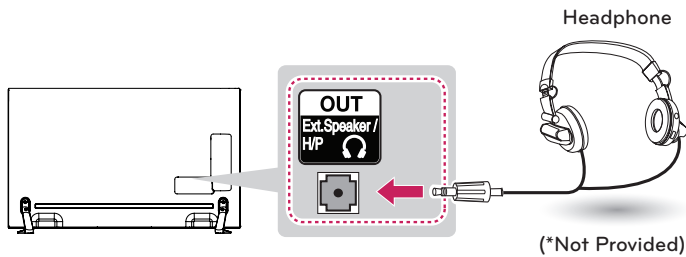

Connecting a USB Device

Connect a USB storage device such as USB flash memory, external hard drive, or a USB memory card reader to the TV and access the Smart Share menu to use various multimedia files.

NOTE

- Some USB Hubs may not work. If a USB device connected using a USB Hub is not detected, connect it directly to the USB port on the TV.

Choose any USB input port to connect.
It does not matter which port you use.

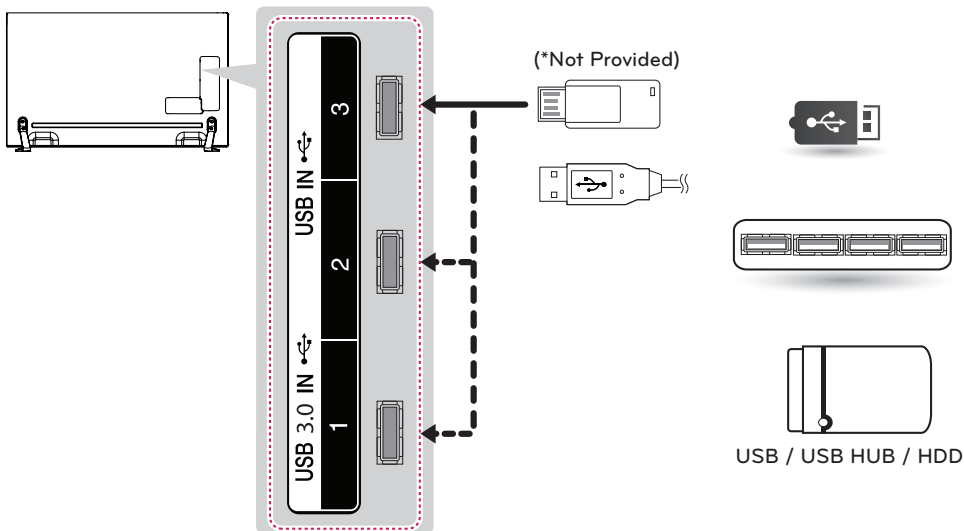

MAGIC REMOTE CONTROL FUNCTIONS

When the message *Magic remote control battery is low. Change the battery.* is displayed, replace the battery. To install batteries, open the battery cover, replace batteries (1.5 V AA) matching ⊕ and ⊖ ends to the label inside the compartment, and close the battery cover. Failure to match the correct polarities of the battery may cause the battery to burst or leak, resulting in fire, personal injury, or ambient pollution. Be sure to point the remote control at the remote control sensor on the TV. To remove the batteries, perform the installation actions in reverse.

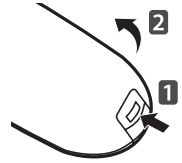

CAUTION

- Do not mix old and new batteries, as this may damage the remote control.

This remote uses infrared light. When in use, it should be pointed in the direction of the TV's remote sensor.

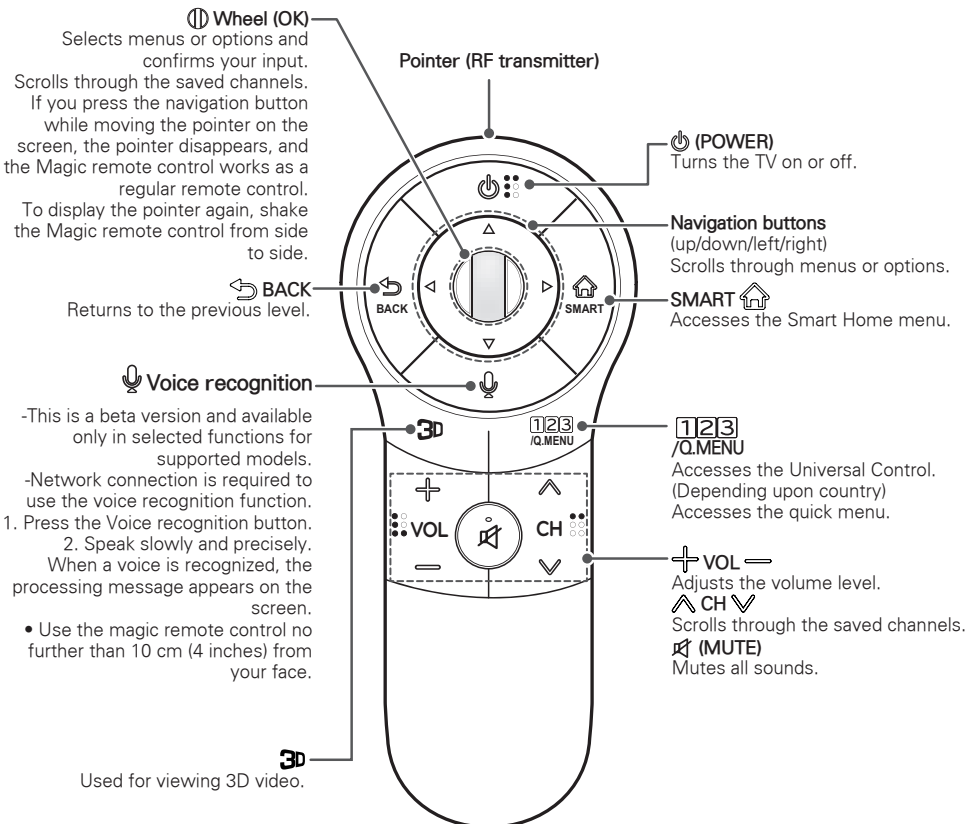

Registering Magic Remote Control

The Magic Remote Control operates by pairing with your TV.

Please register the remote as follows.

How to register the Magic Remote Control

 (Wheel)	<p>To register automatically, turn the TV on and press the Wheel (OK). When registration is completed, the completion message appears on the screen.</p> <p>If registration fails, turn the TV off and back on, then press the Wheel (OK) to complete registration.</p>
--	---

How to Re-register the Magic Remote Control

 BACK  SMART	<p>1 Press and hold the BACK and SMART buttons together for 5 seconds to reset, then register it by following How to register the Magic remote control above.</p> <p>2 To re-register the Magic remote control, press and hold the BACK button for 5 seconds toward the TV.</p>
---	---

How to use Magic Remote Control

	<p>1 You can move the pointer by aiming the Pointer Receiver of the remote control at your TV then move it left, right, up or down.</p> <ul style="list-style-type: none"> » If the pointer does not work properly, leave the remote control for 10 seconds then use it again. <p>2 If the pointer disappears, move the remote control slightly to left or right. Then, it will automatically appear on the screen.</p> <ul style="list-style-type: none"> » If the pointer has not been used for a certain period of time, it will disappear.
--	--

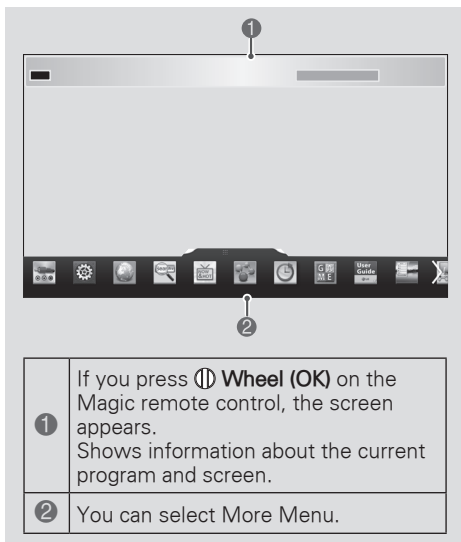

Precautions to Take when Using the Magic Remote Control

- Use the Magic remote control within the maximum communication distance (10 m, 32.8 ft). Using the remote control beyond this distance, or with an object obstructing it, may cause a communication failure.
- A communication failure may occur due to nearby devices. Electrical devices such as a microwave oven or wireless LAN product may cause interference, as these use the same bandwidth (2.4 GHz) as the Magic remote control.
- The Magic remote control may be damaged or may malfunction if it is dropped or receives a heavy impact.
- Take care not to bump into nearby furniture or other people when using the Magic remote control.
- Manufacturer and installer cannot provide service related to human safety as the applicable wireless device has possibility of electric wave interference.
- It is recommended that an Access Point (AP) be located more than 1 m (3.28 ft) away from the TV. If the AP is installed closer than 1 m (3.28 ft), the Magic remote control may not perform as expected due to frequency interference.

WATCHING TV

Turning the TV on for the First Time

When you turn the TV on for the first time, the Initial setting screen appears. Select a language and customize the basic settings.

- 1 Connect the power cord to a power outlet.
- 2 In Standby mode, press the power button on the remote control to turn the TV on. The Initial setting screen appears if you turn the TV on for the first time.

! NOTE

- You can also access **Initial Setting** by accessing **OPTION** in the main menu.

- 3 Follow the on-screen instructions to customize your TV settings according to your preferences.

Language Selection

Selects a language to display.



Environment Selection

Select **Home** for the home environment.



Time Zone Setting

Selects the time zone and daylight saving. (Depending upon country)



Network Connection

Sets your network to enable network-related features on the TV.



Select TV watching Type

Set the TV and set-top box for each watching type. (Depending upon country)



Auto Tuning

Scans and saves available channels automatically.



Setting is complete

Confirms the setting options.



Experience Magic Remote Control

Simple guide of Magic Remote Control (Depending upon model)

! NOTE

- Select **Home** when prompted. **Store** mode puts the TV in demo mode.
- If you select **Store**, the any customized settings will switch back to the default settings of **Store** in 5 minutes.
- The Standby light feature is disabled in Store Demo mode.

- 4 When the basic settings are complete, press the **Wheel (OK)**.

! NOTE

- If you do not complete the initial setting, it will appear whenever the TV turns on.
- Disconnect the power cord from the power outlet when you do not use the TV for a long period of time.



- 5 To turn the TV off, press the power button on the remote control.

USING THE USER GUIDE

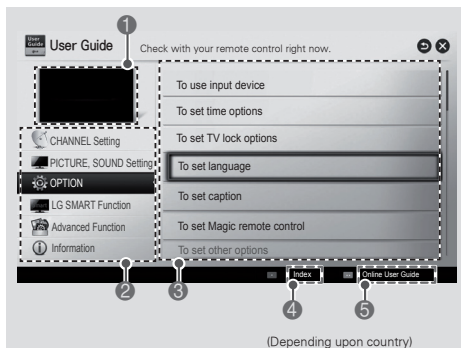
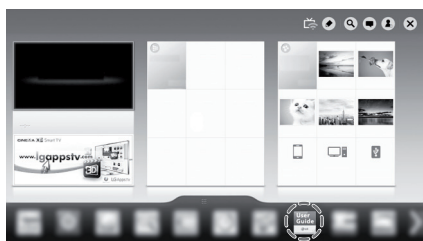

User Guide allows you to access detailed TV information easily.

- 1 Press **SMART**  button to access the Smart Home menu.
- 2 Select **User Guide** and press the **Wheel** (OK) button.

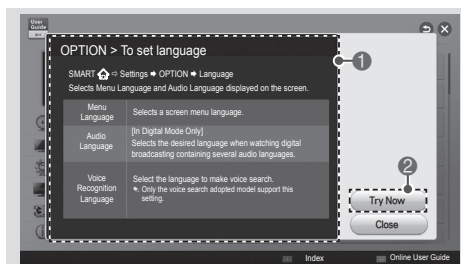

1	Shows the video you were watching.
2	Guide categories.
3	List of topics in the current category. You can use  /  button to move between pages.
4	An index of key words present in the User Guide.
5	Provides the detailed information on the functions of LG Smart TV when the Internet is connected. (It may not be available depending upon the country/language.)



1	Shows the description of the selected menu. You can use  /  to move between pages.
2	Moves to the selected menu directly from the User Guide.

SPECIFICATIONS

Product specifications may be changed without prior notice due to upgrade of product functions.

Power requirement		AC 120 V~ 50/60 Hz
Television System		NTSC-M, ATSC, 64 & 256 QAM
Program Coverage		VHF 2-13, UHF 14-69, CATV 1-135, DTV 2-69, CADTV 1-135
External Antenna Impedance		75 Ω
Environment condition	Operating Temperature	0 °C ~ 40 °C (32 °F ~ 104 °F)
	Operating Humidity	Less than 80 %
	Storage Temperature	-20 °C ~ 60 °C (-4 °F ~ 140 °F)
	Storage Humidity	Less than 85 %

MODELS		55LA9650 (55LA9650-UA)
Dimensions (Width x Height x Depth)	With stand	1,234 x 790 x 261 (mm)
		48.5 x 31.1 x 10.2 (inch)
	Without stand	1,234 x 755 x 41.9 (mm)
		48.5 x 29.7 x 1.6 (inch)
Weight	With stand	26.1 kg (57.5 lbs)
	Without stand	24.6 kg (54.2 lbs)
Current Value / Power consumption		1.9 A / 190 W

MODELS		65LA9650 (65LA9650-UA)
Dimensions (Width x Height x Depth)	With stand	1,455 x 912 x 294 (mm)
		57.2 x 35.9 x 11.5 (inch)
	Without stand	1,455 x 881 x 43.5 (mm)
		57.2 x 34.6 x 1.7 (inch)
Weight	With stand	36.8 kg (81.1 lbs)
	Without stand	35 kg (77.1 lbs)
Current Value / Power consumption		2.5 A / 250 W

HDMI (DTV) supported mode

(HDCP 1.4)

Resolution	Horizontal Frequency (kHz)	Vertical Frequency (Hz)
720 x 480	31.469 31.50	59.94 60.00
1280 x 720	44.96 45.00	59.94 60.00
1920 x 1080	33.72 33.75 26.97 27.000 33.716 33.75 67.43 67.500	59.94 60.00 23.97 24.000 29.976 30.00 59.94 60
3840 x 2160	53.95 54 56.25 61.43 67.5	23.976 24.00 25.00 29.970 30.00

Component supported mode

Resolution	Horizontal Frequency (kHz)	Vertical Frequency (Hz)
720 x 480i	15.73 15.73	59.94 60.00
720 x 480p	31.47 31.50	59.94 60
1280 x 720p	44.96 45.00	59.94 60.00
1920 x 1080i	33.72 33.75	59.94 60.00
1920 x 1080p	26.97 27.00 33.71 33.75 67.432 67.500	23.976 24.00 29.97 30.00 59.94 60.00

Component port connecting information

Component ports on the TV	Y	PB	PR
Video output ports on DVD player	Y	PB	PR
	Y	B-Y	R-Y
	Y	Cb	Cr
	Y	Pb	Pr

HDMI (PC) supported mode

(HDCP 1.4)

Resolution	Horizontal Frequency (kHz)	Vertical Frequency (Hz)
640 x 350	31.468	70.09
720 x 400	31.469	70.08
640 x 480	31.469	59.94
800 x 600	37.879	60.31
1024 x 768	48.363	60.00
1152 x 864	54.348	60.053
1280 x 1024	63.981	60.020
1360 x 768	47.712	60.015
1920 x 1080	67.5	60.00
3840 x 2160	54 56.25 67.5	24.00 25.00 30.00

Wireless LAN module (WN8122E1) specification

Standard	IEEE802.11a/b/g/n
Frequency Range	2400 to 2483.5 MHz 5150 to 5250 MHz 5725 to 5850 MHz
Output Power (Max.)	802.11a: 16.5 dBm 802.11b: 16 dBm 802.11g: 15.5 dBm 802.11n - 2.4GHz: 15.5 dBm 802.11n - 5GHz: 16.5 dBm

- Because band channel used by the country could be different, the user can not change or adjust the operating frequency and this product is set for the regional frequency table.
- Contains FCC ID: BEJWN8122E1
Contains IC: 2703H-WN8122E1

Bluetooth module (BM-LDS401) specification

Standard	Bluetooth Version 3.0
Frequency Range	2400 ~ 2483.5 MHz
Output Power (Max.)	10 dBm or lower

- Contains FCC ID: BEJLDS401
Contains IC: 2703H-LDS401

[ULTRA HD] Video Supported Codec

- Maximum : 3840 x 2160 @ 30p
- Maximum data transfer rate
3840 x 2160 (H.264 L5.1) : 50Mbps (megabits per second)
3840 x 2160 (HEVC L5.0) : 25Mbps (megabits per second)

Extension	Codec	
.mkv / .mp4 / .ts	Video	H.264 / AVC
	Audio	Dolby Digital, Dolby Digital Plus, AAC, HE-AAC
.ts	Video	HEVC
	Audio	Dolby Digital, Dolby Digital Plus, AAC, HE-AAC

! NOTE

- New codecs can be updated through SW upgrade.
- Video files created by some encoders may not be played back.
- LG's ULTRA HD is fully compatible with most of ULTRA HD contents encode in HEVC delivering stunning high resolution contents. However it may not support certain types of codec contents.
- Video files in formats other than the ones specified here may not be played back.
- Playback of video files stored on a USB device that does not support High Speed, may not work properly.
- Some subtitles created by users may not work properly.
- The video and subtitle files should be placed in the same folder. In this case, you must assign the same names for the video and subtitle files for proper display.
- It supports the playback through USB only.
- Some ULTRA HD models need connection with "ULTRA HD Upgrade Kit".

3D supported mode

- Video, which is input as below media contents is switched into the 3D screen automatically.

3D supported mode automatically					
Input	Signal	Horizontal Frequency (kHz)	Vertical Frequency (Hz)	Playable 3D video format	
HDMI	1080p	54.00	24	F/P, L/A	
		67.50	30		
		27.00	24	S/S, T&B, S/S Full	
		33.75	30		
		67.50	60		
	1080i	67.50	60	F/P, F/A	
		33.75		S/S, T&B, S/S Full	
	720p	90.00		F/P, L/A	
		45.00		S/S, T&B, S/S Full	
	480p	63.00		F/P, L/A	
		31.50		T/B, S/S, S/S Full	
	USB	1080p		33.75	30
DLNA					

S/S : Side by Side, S/S Full : Side by Side Full, S/S Half : Side by Side Half,

T/B : Top & Bottom, F/P : Frame Packing, F/A : Field Alternative, L/A : Line Alternative, C/B : Checker Board,
R/I : Row Interleaving, C/I: Column Interleaving, F/S : Single Frame Sequential

3D supported mode manually		
Input	Signal	Playable 3D video format
TV	-	2D to 3D, S/S, T&B
ATV (CVBS)	-	
Component	-	
HDMI-PC	1080p	2D to 3D, S/S, T&B, C/B, R/I, C/I (60Hz : F/S)
	Others	2D to 3D, S/S, T&B
HDMI-DTV	Interlace	2D to 3D, S/S, T&B
	Progressive	2D to 3D, S/S, T&B, C/B, R/I, C/I (60Hz : F/S)
USB / DLNA (Movie)	704 x 480p (Over)	2D to 3D, S/S, T&B, C/B, R/I, C/I (60Hz : F/S)
	704 x 480i (Over)	2D to 3D, S/S, T&B
	704 x 480 (Under)	2D to 3D
USB / DLNA (Photo)	320 x 240 (Over)	2D to 3D, S/S, T&B
	320 x 240 (Under)	2D to 3D
Miracast™ / WiDi	1024 x 768p	2D to 3D, S/S, T&B
	1280 x 720p	
	1920 x 1080p	
	Others	2D to 3D

EXTERNAL CONTROL DEVICE SETUP

To obtain the external control device setup information, please visit www.lg.com.

MAINTENANCE

Cleaning Your TV

Clean your TV regularly to keep it at peak performance and to extend the product lifespan.

CAUTION

- Before cleaning, turn the power off and disconnect the power cord and all other cables.
- When the TV is left unattended or unused for a long time, disconnect the power cord from the wall outlet to prevent possible damage from lightning or power surges.

Screen, Frame, Cabinet, and Stand

To remove dust or light dirt, wipe the surface with a dry, clean, and soft cloth.

To remove major dirt, wipe the surface with a soft cloth dampened in clean water or a diluted mild detergent. Then wipe immediately with a dry cloth.

CAUTION

- Do not push, rub, or hit the surface with your fingernail or a sharp object, as this may result in scratches on the screen and image distortions.
- Do not use any chemicals, such as waxes, benzene, alcohol, thinners, insecticides, air fresheners, or lubricants, as these may damage the screen's finish and cause discoloration.
- Do not spray liquid onto the surface. If water enters the TV, it may result in fire, electric shock, or malfunction.

Power Cord

Remove the accumulated dust or dirt on the power cord regularly.

TROUBLESHOOTING

Problem	Solution
Cannot control the TV with the remote control.	<ul style="list-style-type: none"> • Check the remote control sensor on the product and try again. • Check if there is any obstacle between the product and the remote control. • Check if the batteries are still working and properly installed (⊕ to ⊕, ⊖ to ⊖).
No image display and no sound is produced.	<ul style="list-style-type: none"> • Check if the product is turned on. • Check if the power cord is connected to a wall outlet. • Check if there is a problem in the wall outlet by connecting other products.
The TV turns off suddenly.	<ul style="list-style-type: none"> • Check the power control settings. The power supply may be interrupted. • Check if the Off Time/Sleep Timer is activated in the TIME settings. • If there is no signal while the TV is on, the TV will turn off automatically after 15 minutes of inactivity.



The model and serial number of the TV is located on the back and one side of the TV. Record it below should you ever need service.

MODEL _____

SERIAL _____

LG Customer Information Center

For inquires or comments, visit www.lg.com or call;

1-888-542-2623

CANADA

1-800-243-0000

USA, Consumer User

1-888-865-3026

USA, Commercial User

Register your product Online!

www.lg.com