



ENGLISH

OWNER'S MANUAL

Micro Hi-Fi System

Please read this manual carefully before operating your set and retain it for future reference.

CM2540



www.lg.com

Safety Information



CAUTION: TO REDUCE THE RISK OF ELECTRIC SHOCK DO NOT REMOVE COVER (OR BACK) NO USER-SERVICEABLE PARTS INSIDE REFER SERVICING TO QUALIFIED SERVICE PERSONNEL.



This lightning flash with arrowhead symbol within an equilateral triangle is intended to alert the user to the presence of uninsulated dangerous voltage within the product's enclosure that may be of sufficient magnitude to constitute a risk of electric shock to persons.



The exclamation point within an equilateral triangle is intended to alert the user to the presence of important operating and maintenance (servicing) instructions in the literature accompanying the product.

WARNING: TO PREVENT FIRE OR ELECTRIC SHOCK HAZARD, DO NOT EXPOSE THIS PRODUCT TO RAIN OR MOISTURE.

WARNING: Do not install this equipment in a confined space such as a book case or similar unit.

CAUTION: Do not block any ventilation openings. Install in accordance with the manufacturer's instructions.

Slots and openings in the cabinet are provided for ventilation and to ensure reliable operation of the product and to protect it from over heating. The openings shall be never be blocked by placing the product on a bed, sofa, rug or other similar surface. This product shall not be placed in a built-in installation such as a bookcase or rack unless proper ventilation is provided or the manufacturer's instruction has been adhered to.

CAUTION: This product employs a Laser System. To ensure proper use of this product, please read this owner's manual carefully and retain it for future reference. Shall the unit require maintenance, contact an authorized service center. Use of controls, adjustments or the performance of procedures other than those specified herein may result in hazardous radiation exposure. To prevent direct exposure to laser beam, do not try to open the enclosure.

CAUTION concerning the Power Cord

Most appliances recommend they be placed upon a dedicated circuit;

That is, a single outlet circuit which powers only that appliance and has no additional outlets or branch circuits. Check the specification page of this owner's manual to be certain. Do not overload wall outlets. Overloaded wall outlets, loose or damaged wall outlets, extension cords, frayed power cords, or damaged or cracked wire insulation are dangerous. Any of these conditions could result in electric shock or fire. Periodically examine the cord of your appliance, and if its appearance indicates damage or deterioration, unplug it, discontinue use of the appliance, and have the cord replaced with an exact replacement part by an authorized service center. Protect the power cord from physical or mechanical abuse, such as being twisted, kinked, pinched, closed in a door, or walked upon. Pay particular attention to plugs, wall outlets, and the point where the cord exits the appliance. To disconnect power from the mains, pull out the mains cord plug. When installing the product, ensure that the plug is easily accessible.

This device is equipped with a portable battery or accumulator.

Safety way to remove the battery or the battery from the equipment: Remove the old battery or battery pack, follow the steps in reverse order than the assembly. To prevent contamination of the environment and bring on possible threat to human and animal health, the old battery or the battery put it in the appropriate container at designated collection points. Do not dispose of batteries or battery together with other waste. It is recommended that you use local, free reimbursement systems batteries and accumulators. The battery shall not be exposed to excessive heat such as sunshine, fire or the like.

CAUTION: The apparatus shall not be exposed to water (dripping or splashing) and no objects filled with liquids, such as vases, shall be placed on the apparatus.

Table of Contents

1 Getting Started

- 2 Safety Information
- 6 Unique Features
 - 6 – Smart Awake Lighting
 - 6 – USB Direct Recording
 - 6 – Radio
 - 6 – Portable In
 - 6 – Made for iPhone/iPod or Android device
 - 6 – LG Bluetooth Remote
- 6 Accessories
- 7 Playable file Requirement
 - 7 – Music file requirement
 - 7 – Compatible USB Devices
 - 7 – USB device requirement
- 8 Remote control
- 10 Front panel
- 11 Rear panel

2 Operating

- 12 – AC Power Cord Connection
- 12 Basic Operations
- 13 – iPhone/iPod Operation
- 15 – Android device Operation
- 16 – USB / CD Operation
- 18 – Selecting a folder
- 18 – Deleting an MP3/WMA/FLAC file
- 19 – Listening to music from your portable device
- 19 – Listening to music with your headphones
- 20 Radio Operations
 - 20 – Listening to the radio
 - 20 – Presetting the Radio Stations
 - 20 – Deleting all the saved stations
 - 20 – Improving poor FM reception
- 21 Other Operation
 - 21 – Programmed Playback
 - 21 – Displaying file information (ID3 TAG)
 - 21 – Resume playback
 - 21 – Turn off the sound temporarily
- 21 Sound adjustment
 - 21 – Setting the sound mode
- 22 Setting the Clock
 - 22 – Setting the alarm
- 23 – Smart Awake Lighting
- 23 – Sleep Timer Setting
- 23 – Dimmer
- 23 – Auto Power Down
- 24 Advanced Operation
 - 24 – Recording on USB
 - 24 – To select recording bit rate and speed
- 25 Using a Bluetooth wireless technology
 - 25 – Listening to music stored on the Bluetooth devices
- 26 Using LG Bluetooth Remote app

3 Troubleshooting

28 Troubleshooting

4 Appendix

29 Trademarks and Licenses

30 Specifications

31 Maintenance

31 - Notes on Discs

31 - Handling the Unit

1

2

3

4

Unique Features

Smart Awake Lighting

The light of unit is gradually brighter on 30 seconds before the set alarm time.

USB Direct Recording

Records music to your USB device.

Radio

Listens to the radio.

Portable In

Listens to music from your portable device. (mp3/wma, Notebook, etc)

Made for iPhone/iPod or Android device

Enjoys music from iPhone/iPod or Android device with simple connection.

LG Bluetooth Remote

You can control this unit with your iPod touch/iPhone or Android device via Bluetooth. This unit and your device must be paired for Bluetooth. Visit "Apple App Store" or "Google Android Market (Google Play Store)" For detailed information, refer to page 26-27.

Accessories

Please check and identify the supplied accessories.

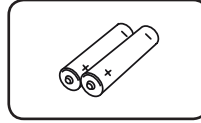

Batteries (2)

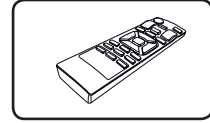

Remote Control (1)

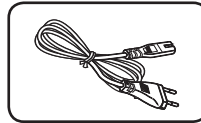

Power cord (1)

Playable file Requirement

Music file requirement

MP3/ WMA/FLAC file compatibility with this unit is limited as follows :

- Sampling frequency :
MP3 : within 8 to 48 kHz
WMA : within 8 to 48 kHz
FLAC : within 8 to 96 kHz(USB),
within 8 to 48 kHz(CD)
- Bit rate : within 8 to 320 kbps (MP3),
40 to 192 kbps (WMA)
- Maximum files : Under 999
- File extensions : ".mp3"/ ".wma"/ ".flac"
- CD-ROM file format : ISO9660/ JOLIET
- Support channel(FLAC) : Up to 2 channel
- Support output bit/sample (FLAC) : 16bit
- bps(FLAC) : Up to 2.5Mbps

The DTS is not supported. In case of DTS audio format, audio is not output.

You have to set the disc format option to [Mastered] in order to make the discs compatible with the LG players when formatting rewritable discs. When setting the option to Live File System, you cannot use it on LG players. (Mastered/ Live File System : Disc format system for Windows Vista)

Compatible USB Devices

- MP3 Player : Flash type MP3 player.
- USB Flash Drive :
Devices that support USB2.0 or USB1.1.
- The USB function of this unit does not support all USB devices.

USB device requirement

- Devices which require additional program installation when you have connected it to a computer, are not supported.
- Do not extract the USB device while in operation.
- For a large capacity USB, it may take longer than a few minutes to be searched.
- To prevent data loss, back up all data.
- If you use a USB extension cable or USB hub, the USB device is not recognized.
- Using NTFS file system is not supported. (Only FAT(16/ 32) file system is supported.)
- This unit is not supported when the total number of files is 1000 or more.
- External HDD, Card readers, Locked devices, or hard type USB devices, mobile phone are not supported.
- USB port of the unit cannot be connected to PC. The unit cannot be used as a storage device.
- Some USB may not work with this unit.
- In power on state, you can charge your iPhone/ iPod/Android device via USB port. (This is available when you selects USB function.)

1

Getting Started

Remote control

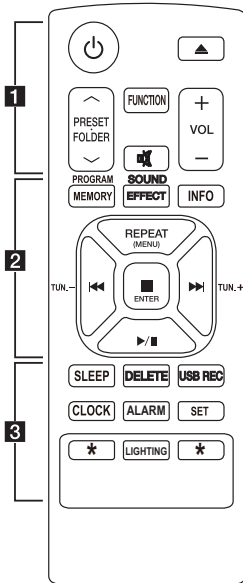

Battery Installation

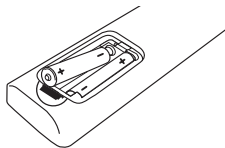

Remove the battery cover on the rear of the Remote Control, and insert two (size AAA) batteries with **+** and **-** matched correctly

..... **1**

- ⏻ (POWER)**: Switches the unit ON or OFF.
- ⏏ (OPEN/CLOSE)**: Ejects the disc from slot loader.

PRESET FOLDER \wedge / \vee :

- Searches for a folder of mp3/wma files. When a CD/USB containing mp3/wma files in several folders is being played, press **PRESET FOLDER \wedge / \vee** to select the folder you want to play.
- Chooses a preset number for a radio station.

FUNCTION :

- Selects the function and input source.

- **⏻** : Mutes the sound.
- **VOL (+ / -)** : Adjusts speaker volume.

..... **2**

PROGRAM/MEMORY :

- Stores radio stations.
- Creates a playlist you want to listen to.

SOUND EFFECT : Chooses sound impressions.

INFO : Sees information about your music. mp3/wma files often come with ID3 tags. The tag gives the Title, Artist, Album or Time information.

REPEAT (MENU) :

- Listens to your tracks/files repeatedly or randomly.
- Move to the previous menu on iPod mode.

TUN.(-/+) : Selects the radio stations.

⏮/⏭ (SKIP/SEARCH):

- Skips Fast backward or Forward.
- Searches for a section within a track/file.

■ ENTER :

- Stops playback or recording.
- Choose an item on iPod mode.

▶/⏸ (PLAY/PAUSE) :

- Starts or pauses playback.
- Selects STEREO/MONO.

..... 3

SLEEP : Sets the system to turn off automatically at a specified time. (Dimmer : The display window will be darkened by half.)

DELETE : Deletes MP3/WMA/FLAC files.

USB REC : USB direct recording.

CLOCK : Sets a clock and checks a time.

ALARM: Uses your player as an alarm clock.

SET :

- Confirms the clock and the alarm setting.

✱ : The button is not available for any function.

LIGHTING : Selects a LIGHTING ON / OFF mode of unit.

✱ : The button is not available for any function.

Front panel

1
Getting Started

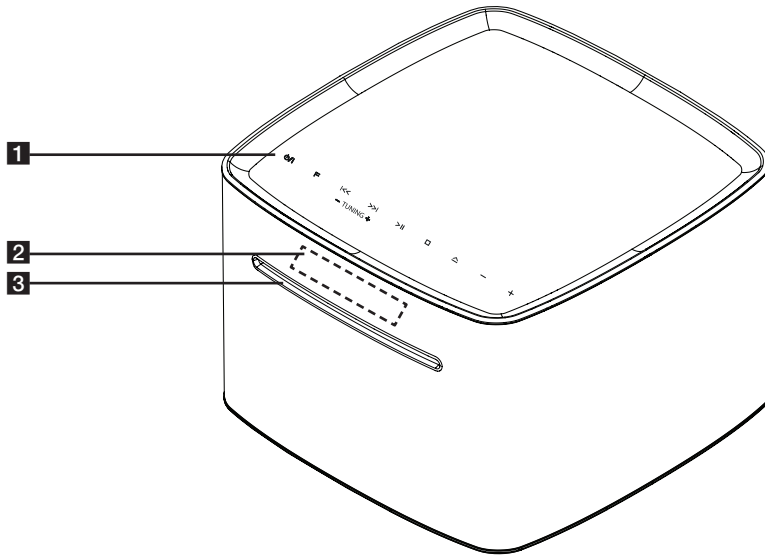

1 |

- Switches the unit ON or OFF.
- When you turn on the device, the bottom of the device is turned on the lights.
- The light will remain while the device is turned on.

F

Selects the function and input source.

- Skips Fast backward or Forward.
- Searches for a section within a track/file.

TUNNING - / +

Selects the radio stations.

Starts and pauses playback.

Stops playback or cancels DELETE function.

Inserts or ejects a disc from a slot loader.

- / +

Adjusts volume level.

2 Display window

3 Disc slot Loads a disc.

Caution

Precautions in using the touch buttons

- Use the touch buttons with clean and dry hands.
 - In a humid environment, wipe out any moisture on the touch buttons before using.
- Do not press the touch buttons hard to make it work.
 - If you apply too much strength, it can damage the sensor of the touch buttons.
- Touch the button that you want to work in order to operate the function correctly.
- Be careful not to have any conductive material such as metallic object on the touch buttons. It can cause malfunctions.

Rear panel

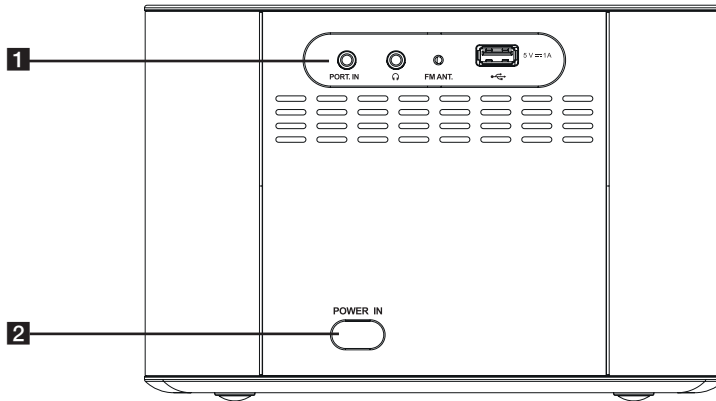

1 PORT. IN

Listens to music from your portable device.



Listens to music with your headphone. (3.5 mm)

FM ANT.

Connects the FM wired antenna.



(USB Port)

- Plays and records the audio files by connecting the USB device.

- Plays the audio files using your USB cable for iPhone/iPod and Android.

2 POWER IN

AC Power Cord Connection

1. Connect one end of the AC power cord (included) to the POWER IN socket.
2. Plug the Power cord into the wall outlet.

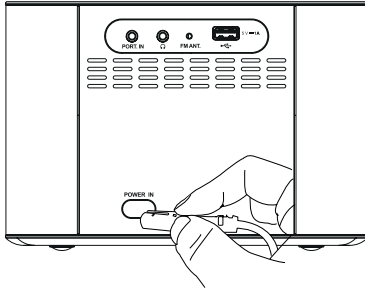

! Note

Unplug the AC power cord from the wall outlet if you do not use for an extended period of time.

Basic Operations

When you select USB function, you can see messages as follows;

Message	Cause
CHARGE	Your device is not supported by AOA 2.0(Only charging)
Number of files	This unit recognizes your USB.
IPOD	This unit recognizes your iOS device as a known device.
ANDROID	This unit recognizes your Android device supported by AOA 2.0 as a known device.
NO USB	Any device is not connected to USB port. This unit recognizes your Android device as an unknown device.

! Note

Depending on the type of device, Message will appear in other way.

iPhone/iPod Operation

You can enjoy the sound with your iPhone/iPod.

For details about iPhone/iPod, refer to the iPhone/iPod User Guide.

1. Connect iPhone/iPod to the USB port by using the iPhone/iPod's cable.

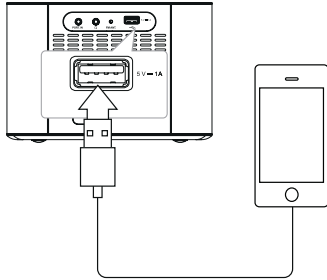

2. Press **FUNCTION** on the remote control or **F** on the unit to select USB function.
3. If your unit is connected firmly, 'IPOD' will appear in the display window. You can operate your iPod device through an iPod device's display by using the remote control and controlling your iPod device.

To	Do this
Pauses or restart	Press ▶/ on the remote control or > on the unit.
Skipping to the next/previous track/file	Press ◀/▶ on the remote control or ◀/▶ on the unit to skip the track/file in stop status.
	During playback, press ▶▶ on the remote control or >> on the unit to go to the next track/file. Playing after 3 seconds, press ◀◀ on the remote control or twice ◀◀ on the unit to go to the beginning of the track/file.
Searching for a section within a track/file	Press and hold ◀◀/▶▶ on the remote control or ◀◀/▶▶ on the unit during playback and release it at the point you want to listen to.
Move to the previous menu	Press REPEAT (MENU) on the remote control.
Move to the desired item	Press PRESET FOLDER ▲/▼ on the remote control.
Chooses a item	Press ■ ENTER on the remote control or □ on the unit.

Compatible iPhone/iPod

The unit supports the models as follows.

iPod touch (3rd and 5th generation)

iPod nano (4rd and 7th generation)

iPhone 5S

iPhone 5C

iPhone 5

iPhone 4S

iPhone 4

iPhone 3GS

Depending on your iPhone/iPod's software version, you may not control your iPhone/iPod from the unit.

iPhone, iPod nano, and iPod touch are trademarks of Apple Inc., registered in the U.S. and other countries. Lightning is a trademark of Apple Inc.

Note

- An Error can occur as per below conditions.
 - Your iPhone/iPod is not connected firmly.
 - This unit recognizes your iPhone/iPod as an unknown device.
 - Your iPhone/iPod is exceptionally low in power.
 - ▶ The battery needs to be charged.
 - ▶ If you charge the battery while iPhone/iPod is extremely low in power, it may take longer to be charged.
- When you disconnect your iPhone/iPod during playback, the playback pauses.
- When your iPhone/iPod is connected, you cannot control the volume button of your iPhone/iPod.
- You may not control your iPhone/iPod from this unit due to malfunction of iPhone/iPod.
- Depending on your iPhone/iPod's software version, it may not be possible to control your iPhone/iPod from this unit. We recommend installing the latest software version.
- If you have a problem with your iPhone/iPod, please visit www.apple.com/support.

Android device Operation

You can enjoy the sound from your Android device through USB port. For details about Android device, refer to the Android device User Guide.

To stream audio from your Android device through this unit, you need :

- With Android operation system : Ver 4.1(or later) and AOA 2.0 (or later)
- With a micro USB cable

! Note

It is possible that certain devices may not support or be compliant with the AOA2.0 USB audio standard, resulting in the device freezing or rebooting after being connected and detached from the speaker system.

If you experience this problem, please contact your device manufacturer. Your device may need to be updated with the latest Jellybean software and or the correct AOA2.0 USB audio standard.

You can recommended to remove the case for your Android device (Ver 4.1 or later) before you connect your Android device to USB port using a cable.

*About AOA (Android Open Accessory) 2.0 version ;
Audio output from Android device to the Accessory and HID (Human Interface Device)

2. Press **FUNCTION** on the remote control or **F** on the unit to select USB function.
3. If your unit is connected firmly, 'ANDROID' will appear in the display window.
You can operate your Android device through an Android device's display by using the remote control and controlling your Android device.

To	Do this
Play	Press > .
Pause	During playback, press > .
Skip	During playback, press <<< / >>> to go to the next file or to return to the beginning of the current file. During playback, press <<< twice briefly to step back to the previous file.

1. Connect Android device to the USB port by using the Android device's cable.

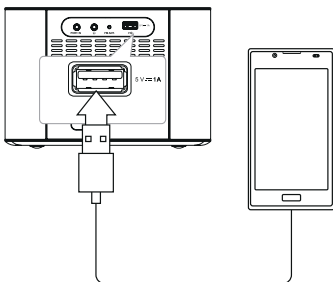

! Note

- If the connection has an error, check these problems as follows;
 - Your Android device is not connected firmly.
 - This unit recognizes your Android device as an unknown device.
 - Your Android device is not booted.
 - Check the setting of USB connection type on your Android device.
- In case of no sound from this unit, adjust the volume of your Android device.
- The charging time may vary depending on your Android device.
- Some Android devices may not be charged.
- You may not control your Android device from this unit due to malfunction of Android device.
- Depending on your Android device's software version, it may not be possible to control your Android device from this unit. We recommend installing the latest software version.
- If your Android device does not support AOA (Android Open Accessory) 2.0 version, this unit can only charge your Android device even though Android device has OS 4.1 (or later).

USB / CD Operation**USB Connection**

Connect the USB port of USB Memory (or mp3/wma player, etc.) to the USB port on the unit.

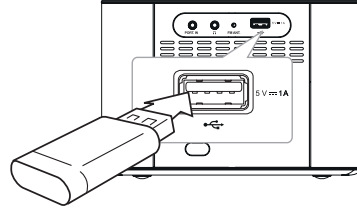
**! Note**

Removing the USB Device from the unit.

1. Choose a different function/mode or press **ENTER** on the remote control or **ENTER** on the unit.
2. Remove the USB device from the unit.

! Caution

- Do not extract the USB device during operation. (play, delete, etc.)
- Regular back up is recommended to prevent data loss.
- The delete function may not be supported according to the USB state. (lock, etc.)

Insert CD

1. Insert a disc in the disc slot with the label side upward.
2. Select the CD function by pressing **FUNCTION** on the remote control or **F** on the unit.
3. Select a track/file you want to play by pressing **◀◀/▶▶** on the remote control.

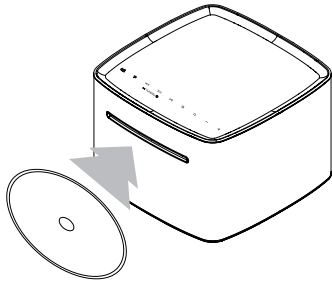

! Note

Music CDs or CD-R/CD-RW in music CD format can be only played.(12 cm disc)

USB / CD to use

To	Do this
Stop	Press ■ ENTER on the remote control or □ on the unit.
Playback	Press ▶/ on the remote control or > on the unit.
Pause	During playback, Press ▶/ on the remote control or > on the unit.
Skipping to the next/previous track/ file	Press ◀◀/▶▶ on the remote control or ◀◀/▶▶ on the unit to skip the track/file in stop status.
	During playback, press ▶▶ on the remote control or >> on the unit to go to the next track/file.
	Playing less than 2 seconds, press ◀◀ on the remote control or ◀◀ on the unit to go to the previous track/file.
Searching for a section within a track/ file	During playing the music within 3 seconds, press twice ◀◀ on the remote control or twice ◀◀ on the unit to the previous track/file.
	Press and hold ◀◀/▶▶ on the remote control or ◀◀/▶▶ on the unit during playback and release it at the point you want to listen to.
Playing repeatedly or randomly	Press REPEAT(MENU) on the remote control repeatedly, the display window will be changed in the following order, RPT1 -> RPT DIR (only MP3/WMA) -> RPT ALL -> RANDOM -> OFF * DIR : Directory

Selecting a folder

1. In stop status, press **PRESET FOLDER** \wedge/V on the remote control repeatedly until a desired folder appears.
2. Press **▶/||** to play it. The first file of folder will be played. (During playback, if you select a folder you want, this step is not necessary.)

Note

- CD / USB Folders/Files are recognized as below.

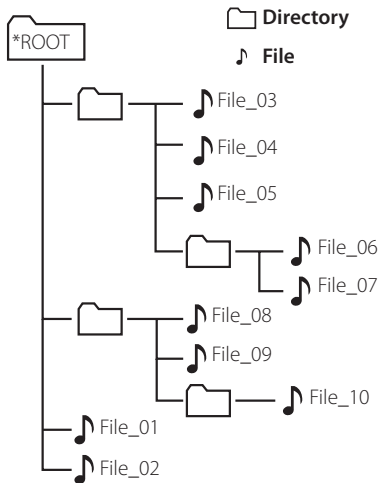

- Files and folders will be presented in order recorded and may be presented differently according to the record circumstances.
- *ROOT : the first screen you can see when a computer recognize the USB is "ROOT"
- Folders will be presented as the following order;
FAT(USB) / CD : FILE_01 -> FILE_02 ->
FILE_03 -> FILE_04 -> FILE_05 -> FILE_06 ->
FILE_07 -> FILE_08 -> FILE_09 -> FILE_10

Deleting an MP3/WMA/FLAC file

You can delete file, folder or format by pressing **DELETE**. This function is supported only in stop status. (USB only)

1. -Select the file you want to delete and press **DELETE**.

-Select the folder you want to delete by pressing **PRESET FOLDER** \wedge/V . Then press **DELETE**.

-Press and hold **DELETE** to format the USB device.

Or

Press **DELETE** repeatedly during selecting the MP3/WMA file.

The display changes in the following order.

- DEL FILE : Deletes file
- DEL DIR? : Deletes folder
- FORMAT? : Formats USB

2. To delete file/folder or format, press **▶/||** on the remote control or press **>||** on the unit.
3. If you want to exit the current mode, press **■ ENTER** on the remote control or press **□** on the unit.

Listening to music from your portable device

The unit can be used to play the music from many types of portable device.

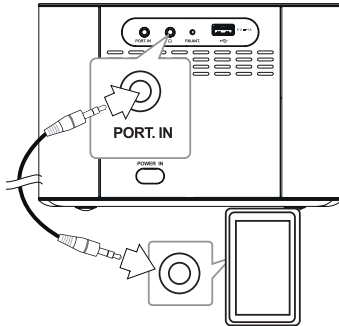

1. Connect the portable device to the **PORT. IN** connector of the unit.
2. Turn the power on by pressing .
3. Select the PORTABLE function by pressing **FUNCTION** on the remote control.
4. Turn the portable device on and start playing it.

Listening to music with your headphones

Connect a pair of stereo headphones (\varnothing 3.5 mm phone plug) to  on the unit for private listening.

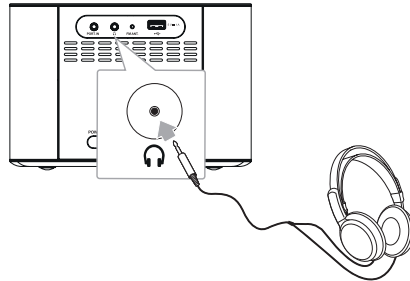

Note

You can't hear any sound from speakers, while the headphones plug is inserted in the .

Radio Operations

Listening to the radio

1. Press **FUNCTION** on the remote control or **F** on the unit, until Tuner in the display window. The last received station is tuned in.
2. Auto tuning : Press and hold **TUN.(-/+)** on the remote control or **|<</>>|** on the unit for about 2 seconds until the existing frequency starts changing, then hands off. Scanning stops when the unit tunes in a station.
Manual tuning : Press **TUN.(-/+)** on the remote control or **|<</>>|** on the unit repeatedly.
3. Adjust the volume by pressing **-/+**.

Presetting the Radio Stations

You can preset 50 stations for FM . Before tuning, make sure to turn down the volume.

1. Press **FUNCTION** on the remote control or **F** on the unit, until Tuner in the display window. The last received station is tuned in.
2. Select the desired frequency by pressing **TUN.(-/+)** on the remote control or **|<</>>|** on the unit.
3. Press **PROGRAM/MEMORY**. A preset number will blink in the display window.
4. Press **PRESET FOLDER \wedge /V** to select the preset number you want.
5. Press **PROGRAM/MEMORY**. The station is stored.
6. Repeat steps 2 to 5 to store other stations.
7. To listen a preset station, press **PRESET FOLDER \wedge /V**.

Deleting all the saved stations

1. Press and hold **PROGRAM/MEMORY** for two seconds. "CLEAR" will blink on the display window.
2. Press **PROGRAM/MEMORY** to erase all saved radio stations.

Improving poor FM reception

Press **▶/||** on the remote control. This will change the tuner from stereo to mono. Then the reception will be better than before.

Note

Be sure to fully extend the FM wire antenna.

Other Operation

Programmed Playback

The program function enables you to store your favourite tracks/files from any disc or USB device.

A program can contain 20 tracks/files.

1. Insert a CD or connect USB and wait for it to be loaded.
2. Press **PROGRAM/MEMORY** on the remote control in stop state.
3. Press **◀◀/▶▶** on the remote control to select a next track/file.
4. Press **PROGRAM/MEMORY** again to save and select a next track/file.
5. Press **▶/||** to play the programmed music tracks/files.
6. To clear your selection, press twice **■ ENTER** on the remote control and **□** (stop) on the unit.

! Note

The programs are also cleared when the disc or USB device is removed, the unit is powered off or the function is switched to others.

Displaying file information (ID3 TAG)

While playing an mp3/wma file containing file information, you can display the information by pressing **INFO** on the remote control.

Resume playback

During playback, if you change to another function, then return to the USB/CD function, and then press, you can listen to music from last point you played.

Turn off the sound temporarily

Press **⏸** on the remote control to mute your sound. You can mute the sound in order, for example, to answer the telephone. And "MUTE" will blink in the display window. To cancel mute function, press **⏸** again or press **VOL(+/-)** on the remote control or **—/+** on the unit

Sound adjustment

Setting the sound mode

This system has a number of pre-set sound fields. You can select a desired sound mode by using **SOUND EFFECT** on the remote control.

The displayed items for the Equalizer may be different depending on sound sources and effects.

On Display	Description
NATURAL	You can enjoy comfortable and natural sound.
AUTO EQ	Sets the sound equalizer on the mode that is the most similar to the genre which is included in the MP3 ID3 tag of song files.
POP CLASSIC JAZZ ROCK	This program lends an enthusiastic atmosphere to the sound, giving you the feeling you are at an actual rock, pop, jazz or classic concert.
MP3 -- OPT	This function is optimized for compressible MP3 file. It improves the treble sound.
BASS (BASS BLAST)	Reinforces the treble, bass and surround sound effect.
BYPASS	You can enjoy the sound without equalizer effect.

! Note

Maybe you need to reset the sound mode, after switching the input, sometimes even after the sound track/file is changed.

Setting the Clock

You have three ways to set the clock.

1. Turn the unit on.
2. Press **CLOCK** for at least 2 seconds.
3. Choose time mode by pressing **◀▶** on the remote control or **◀▶** on the unit.
- 12:00 (for an AM and PM display) or 0:00 (for a 24 hour display)
4. Press **SET** to confirm your selection.
5. Select the hours by pressing **◀▶** on the remote control or **◀▶** on the unit.
6. Press **SET** to confirm your selection.
7. Select the minutes by pressing **◀▶** on the remote control or **◀▶** on the unit.
8. Press **SET** to confirm your selection.
9. If you want to reset the clock, press and hold **CLOCK**. Then repeat steps 3-8.

Setting the Clock through "LG Bluetooth Remote" App

Install "LG Bluetooth Remote" app on your Android device. (see page 26 - 27)

Your unit's clock will be automatically synchronized with your device by activating Bluetooth connection through "LG Bluetooth Remote" app.

Setting the clock by synchronizing your iPhone/iPod

Connect iPhone/iPod to the USB port using the iPhone/iPod's cable and select USB function. Then the clock setting in the display window will be synchronized with your iPhone/iPod.

After the unit synchronized with your iPhone/iPod for clock setting, there will be a time difference between the iPhone/iPod and the unit. In power off state, the clock won't be synchronized with your iPhone/iPod.

Setting the alarm

You can use the unit as an alarm clock.

You have to set the clock before setting the alarm.

1. Turn the unit on.
2. Press **ALARM**. Each of functions flashes.
3. Press **SET** when the function you want to be woken by is showing.
4. "ON TIME" will be displayed. This is your desired time to turn unit on. Press **◀▶** on the remote control or **◀▶** on the unit to change the hours and minutes and press **SET** to save.
5. Press **◀▶** on the remote control or **◀▶** on the unit to change the volume and press **SET** to save.
6. If you want to reset the alarm, press and hold **ALARM**. Then repeat steps 3-5

Note

- Alarm function only works when the unit is turned off after setting the alarm.
- If you set the clock time and alarm, you can check the time by pressing **CLOCK** or the alarm by pressing **ALARM** even when the unit is turned off.
- If the alarm is already set, press **ALARM** once to cancel the alarm. To activate the alarm, press **ALARM** once again.
- If the clock time or the alarm is already set, press and hold **CLOCK** or **ALARM** for at least 2 seconds to reset the clock or the alarm.

Smart Awake Lighting

The light of unit is gradually brighter on 30 seconds before the set alarm time that user used to the alarm function of the unit or the alarm function of LG Bluetooth app.

- The light off automatically after 30 minutes if you have set the alarm time between 8:00 a.m. to 5:00 p.m.
- The light is still on until you press **LIGHTING** on the remote control if you have set the alarm time between 5:00 p.m. to 8:00 a.m.

Sleep Timer Setting

Press **SLEEP** repeatedly to select delay time sequence from 180 to 10 minutes. After the delay time, the unit will be turned off.

To cancel the sleep function, press **SLEEP** repeatedly until "SLEEP 10" appears, and then press **SLEEP** once again while "SLEEP 10" is displayed.

! Note

- You can check the remaining time before the unit is turned off.
- Press **SLEEP**. The remaining time appears in the display window.

Dimmer

Press **SLEEP** once. The display window will be darkened by half. To cancel it, press **SLEEP** repeatedly until the display window get bright.

Auto Power Down

This unit will be off itself to save electric consumption in the case the main unit is not connected to the external device and is not used for 20 minutes.

So does this unit after 6 hours since Main unit has been connected to other device using analog input.

Using a Bluetooth wireless technology

About Bluetooth

Bluetooth® is wireless communication technology for short range connection.

The sound may be interrupted when the connection interfered by the other electronic wave or you connect the bluetooth in the other rooms.

Connecting individual devices under **Bluetooth**® wireless technology does not incur any charges. A mobile phone with **Bluetooth**® wireless technology can be operated via the Cascade if the connection was made via **Bluetooth**® wireless technology. Available Devices : Mobile phone, MP3, Laptop, PDA.

Bluetooth Profiles

In order to use **Bluetooth**® wireless technology, devices must be able to interpret certain profiles. This unit is compatible with following profile.

A2DP (Advanced Audio Distribution Profile)

Listening to music stored on the Bluetooth devices

Before you start the pairing procedure, make sure the Bluetooth feature is turned on in to your Bluetooth device. Refer to your Bluetooth device's user guide. Once a pairing operation is performed, it does not need to be performed again.

1. Select the Bluetooth function by using the **FUNCTION** on the remote control or **F** on the unit.
"BT READY" appears on the display window.
2. Operate the Bluetooth device and perform the pairing operation. When searching for this unit with the Bluetooth device, a list of the devices found may appear in the Bluetooth device display depending on the type of Bluetooth device. Your unit appears as "LG MICRO(XX:XX)".

! Note

XX:XX means the last four digits of BT address. For example, if your unit has a BT address such as 9C:02:98:4A:F7:08, you will see "LG MICRO(F7:08)" on your Bluetooth device.

3. Enter the PIN code.
PIN code : 0000
4. When this unit is successfully connected with your Bluetooth device, "BT PAIR" will appear on the display window and bluetooth indicator will be lit up.

! Note

Depending on the Bluetooth device type, some device have a different pairing way.

5. Listen to music.
To play a music stored on your Bluetooth device, refer to your Bluetooth device's user guide.

! Note

- Sound from the main set can be distorted if you raise the volume of Bluetooth device up to two-thirds or more.
- When you use the bluetooth function, adjust the volume of a bluetooth device to a proper level to listen to.

! Note

- When using Bluetooth® technology, you have to make a connection between the unit and the bluetooth device as close as possible and keep the distance. However it may not work well in the case below :
 - There is a obstacle between the unit and the bluetooth device.
 - There is a device using same frequency with **Bluetooth®** technology such as a medical equipment, a microwave or a wireless LAN device.
- The sound may be interrupted when the connection interfered by the other electronic wave.
- You cannot control the Bluetooth device with this unit.
- Pairing is limited one Bluetooth device per one unit and multi-pairing is not supported.
- Depending on the type of the device, you may not be able to use the Bluetooth function.
- You can enjoy wireless system using phone, MP3, Notebook, etc..
- When not connected the Bluetooth, "DISCONN" "BT READY" appears on the control panel.
- When someone stands and interrupts communication between Bluetooth device and the player, the connection will be disconnected.
- The more distant between the unit and the bluetooth device, the lower the sound quality becomes.

Using LG Bluetooth Remote app

About LG Bluetooth Remote app

LG Bluetooth Remote app bring a suite of new features to your unit. To enjoy more features, you are recommended to download and install free "LG Bluetooth Remote".

Install " LG Bluetooth Remote app" through " Apple App Store" or "Google Android Market"

1. Tap the Apple App Store icon or Google Android Market(Google Play Store) icon.
2. In the search bar, type in the "LG Bluetooth Remote" and search it.
3. In the search result list, find and tap "LG Bluetooth Remote" to start downloading Bluetooth app.
4. Tap an icon for installation.
5. Tap an icon for downloading.

! Note

- Make sure that your powered Bluetooth device is connected to the Internet.
- Make sure that your powered Bluetooth device is equipped with " Apple App Store" or "Google Android Market(Google Play Store)"
- If you want to get more information, refer to explanation of BT app in "Apple App Store" or "Google Android Market (Google Play Store)".

Activate Bluetooth with LG Bluetooth Remote app

LG Bluetooth Remote app helps to connect your powered Bluetooth device to the unit.

1. Tap LG Bluetooth Remote app icon on the home screen to open LG Bluetooth Remote app application, and go to the main menu.
2. Tap [Setting] and select the unit you want.
3. If you want to get more information to operate, tap [Setting] and [Help].

! Note

- BT app will be available in the software version as follow;
Android O/S : Ver 2.3.3(or late)
iOS O/S : Ver 4.3(or late)
- While using Bluetooth, you may not activate BT app. Disconnect Bluetooth device you have connected before to use BT app properly.
- If you use Bluetooth app for operation, there would be some differences between Bluetooth app and the supplied remote control. Use the supplied remote control as necessary.
- If you operate BT app with Bluetooth device connected, the Bluetooth connection you have connected before may be disconnected. (Depending on the smartphone's O/S, this process has a difference.)
- Depending on the Bluetooth device, BT.app may not work.
- In Bluetooth function, if you use BT app, the supplied remote control may not work.
- When using BT app for remote control, the operation may differ from the supplied remote control.
- According to the smartphone's operating system, you have some differences for BT app's operation.
- When your Bluetooth device have been already connected with other unit, disconnect the Bluetooth connection first. Then you can control your unit through BT app.
- The connection you've made may be disconnected if you select other application or change the setting of the connected device via BT app. In such case, please check the connection status.
- To prevent a malfunction, you are recommended to connect only one device to this unit.
- Don't connect your smart device by using a cable to USB port. Or else the Bluetooth connection will be disconnected.
- After connection of BT app, music may be output from your device. In this case, try connecting procedure again.

Troubleshooting

Problem	Correction
No Power.	<ul style="list-style-type: none"> • Plug in the power cord. • Check the condition by operating other electronic devices.
No sound.	Press F and check the selected function.
The unit does not start playback.	<ul style="list-style-type: none"> • Insert a playable disc. • Clean the disc. (Refer to the 31 page) • Insert the disc with the label or printed side facing upward.
Radio stations cannot be tuned in properly.	<ul style="list-style-type: none"> • Connect the antenna securely. • Tune to the station manually. • Preset some radio stations, see page 20.
The remote control does not work properly.	<ul style="list-style-type: none"> • Operate the remote control within about 23 ft (7 m). • Remove the obstacle in the path of the remote control and the unit. • Replace the battery with new one.
iPhone/iPod does not work.	Connect your iPhone/iPod using USB cable firmly .
Android device does not work.	<ul style="list-style-type: none"> • Check whether your device's O/S is ver 4.1 (or later) or AOA 2.0 (or later). • Connect your Android device using USB cable firmly.
Clock does not displayed.	<ul style="list-style-type: none"> • Connect your Bluetooth device to your unit through BT app. • Connect your iPhone/iPod using USB cable firmly for time sync.

Trademarks and Licenses



Bluetooth® wireless technology is a system which allows radio contact between electronic devices.

Connecting individual devices under *Bluetooth*® wireless technology does not incur any charges. A mobile phone with *Bluetooth*® wireless technology can be operated via the Cascade if the connection was made via *Bluetooth*® wireless technology.

The *Bluetooth*® word mark and logos are owned by the *Bluetooth*® SIG, Inc. and any use of such marks by LG Electronics is under license.

Other trademarks and trade names are those of their respective owners.

Specifications

General	
Power requirements	Refer to the main label.
Power consumption	Refer to the main label.
Dimensions (W x H x D)	(212 x 144 x 212) mm
Net Weight (Approx.)	2.4 kg
Operating temperature	5 °C to 35 °C (41 °F to 95 °F)
Operating humidity	5 % to 85 %
Bus Power Supply	5 V  1 A

Inputs	
PORT. IN	0.7 Vrms (3.5 mm stereo jack)

Tuner	
FM Tuning Range	87.5 MHz to 108.0 MHz or 87.50 MHz to 108.00 MHz

Amplifier	
Stereo mode	10 W + 10 W
T.H.D	10 %

CD	
Frequency Response	40 Hz to 20 kHz
Signal-to-noise ratio	More than 60 dB
Dynamic range	More than 55 dB

Speakers	
Type	built-in
Impedance	8 Ω
Rated Input Power	10 W
Max. Input Power	20 W

- Design and specifications are subject to change without notice.

Maintenance

Notes on Discs

Handling Discs

Never stick paper or tape on the disc.

Storing Discs

After playing, store the disc in its case. Do not expose the disc to direct sunlight or sources of heat and never leave it in a parked car exposed to direct sunlight.

Cleaning Discs

Do not use strong solvents such as alcohol, benzene, thinner, commercially available cleaners, or anti-static spray intended for older vinyl records.

Handling the Unit

When shipping the unit

Please save the original shipping carton and packing materials. If you need to ship the unit, for maximum protection, re-pack the unit as it was originally packed at the factory.

Keeping the exterior surfaces clean

Do not use volatile liquids such as insecticide spray near the unit.

Wiping with strong pressure may damage the surface.

Do not leave rubber or plastic products in contact with the unit for a long period of time.

Cleaning the unit

To clean the player, use a soft, dry cloth. If the surfaces are extremely dirty, use a soft cloth lightly moistened with a mild detergent solution. Do not use strong solvents such as alcohol, benzene, or thinner, as these might damage the surface of the unit.

Maintaining the Unit

The unit is a high-tech, precision device. If the optical pick-up lens and disc drive parts are dirty or worn, the picture quality could be diminished. For details, please contact your nearest authorized service center.

