

# OWNER'S MANUAL AIR CONDITIONER

Please read this manual carefully before operating your set and retain it for future reference.

TYPE : CEILING CONCEALED DUCT



AIO64



KZ.O.02.0561



The equipment complies with requirements of the Technical Regulation, in terms of restrictions for the use of certain dangerous substances in electrical and electronic equipment.



P/NO : MFL42619401

[www.lg.com](http://www.lg.com)

# TABLE OF CONTENTS

<b>A. Safety Precautions</b> .....	3
<b>B. Product Introduction</b> .....	6
1. Name and function of parts .....	6
2. What to do before operation .....	6
3. Wired Remote Controller .....	6
<b>C. Operating Instructions</b> .....	8
1. Set the Current Time and day of the Week .....	8
2. Weekly Programming .....	9
3. Holiday Setting .....	10
4. Timer Setting .....	10
5. Operation Mode.....	11
6. Cooling/Heating Operation Mode	11
7. For Heat Pump Type .....	12
8. Soft Dry Operation Mode.....	12
9. Auto Operation Mode (Cooling Type) .....	12
10. Auto Operation Mode (Heat Pump Type).....	13
11. Fan Operation Mode .....	13
12. Fan Auto .....	14
13. Auto Restarting Function.....	14
14. Child Lock Function .....	14
<b>D. Maintenance and Service</b> .....	15
1. Indoor Unit.....	15
2. Call the service immediately in the following situations .....	15
3. Operation Tips.....	16
4. Troubleshooting Tips! Save time and money!.....	17
5. Call the service immediately in the following situations .....	17



## FOR YOUR RECORDS

Write the model and serial numbers here:

**Model #** \_\_\_\_\_

**Serial #** \_\_\_\_\_

You can find them on a label on the side of each unit.

**Dealer's Name** \_\_\_\_\_

**Date Purchased** \_\_\_\_\_

- Staple your receipt to this page in the event you need it to prove date of purchase or for warranty issues.



## READ THIS MANUAL

Inside you will find many helpful hints on how to use and maintain your air conditioner properly. Just a little preventive care on your part can save you a great deal of time and money over the life of your air conditioner.

You'll find many answers to common problems in the chart of troubleshooting tips. If you review our chart of

**Troubleshooting Tips** first, you may not need to call for service at all.



## PRECAUTION

- Contact the authorized service technician for repair or maintenance of this unit.
- Contact the installer for installation of this unit.
- The air conditioner is not intended for use by young children or invalids without supervision.
- Young children should be supervised to ensure that they do not play with the air conditioner.
- When the power cord is to be replaced, replacement work shall be performed by authorized personnel only using only genuine replacement parts.
- Installation work must be performed in accordance with the National Electric Code by qualified and authorized personnel only.



# Safety Precautions

To prevent injury to the user or other people and property damage, the following instructions must be followed.

- Incorrect operation due to ignoring instruction will cause harm or damage. The seriousness is classified by the following indications.

**⚠ WARNING** This symbol indicates the possibility of death or serious injury.

**⚠ CAUTION** This symbol indicates the possibility of injury or damage.

## ⚠ WARNING

**Always ground the product.**

- There is a risk of electric shock.

**For electrical work, contact the dealer, seller, a qualified electrician, or an Authorized Service Center. Do not disassemble or repair the product by yourself.**

- There is risk of fire or electric shock.

**Use the correctly rated breaker or fuse.**

- There is risk of fire or electric shock.

**Do not install the product on a defective installation stand. Be sure that the installation area does not deteriorate with age.**

- It may cause product to fall.

**Be sure to check the refrigerant to the used. Please read the label on the product.**

- Incorrect refrigerant used can prevent the normal operation of the unit.

**Do not place a heater or other heating appliances near the power cable.**

- There is risk of fire and electric shock.

**Do not use a defective or underrated circuit breaker. Use the correctly rated breaker and fuse.**

- There is risk of fire or electric shock .

**Always ground the product as per the wiring diagram. Do not connect the ground wire to gas or water pipes lightning rod or telephone ground wire.**

- There is risk of fire or electric shock.

**Do not modify or extend the power cable. If the power cable or cord has scratches or skin peeled off or deteriorated then it must be replaced.**

- There is risk of fire or electric shock.

**Never install the outdoor unit on a moving base or a place from where it can fall down.**

- The falling outdoor unit can cause damage or injury or even death of a person.

**Don't use a power cord, a plug or a loose socket which is damaged.**

- Otherwise it may cause a fire or electrical shock.

**Do not allow water to run into electric parts. Install the unit away from water sources.**

- There is risk of fire, failure of the product, or electric shock.

**Do not use a multi consent. Always use this appliance on a dedicated circuit and breaker.**

- Otherwise it can cause electric shock or fire.

**Install the panel and the cover of control box securely.**

- There is risk of fire or electric shock due to dust , water etc.

**For installation, removal or reinstall , always contact the dealer or an Authorized Service Center.**

- There is risk of fire, electric shock, explosion, or injury.

**When the product is soaked (flooded or submerged) in water , contact an Authorized Service Center for repair before using it again.**

- There is risk of fire or electric shock.

**Do not touch , operate, or repair the product with wet hands. Hold the plug by hand when taking out**

- There is risk of electric shock or fire.

**Do not store or use or even allow flammable gas or combustibles near the product.**

- There is risk of fire.

## Safety Precautions

---

**Indoor/outdoor wiring connections must be secured tightly and the cable should be routed properly so that there is no force pulling the cable from the connection terminals.**

- Improper or loose connections can cause heat generation or fire.

**In indoor unit the step-up capacitor supplies high voltage electricity to the electrical components. Be sure to discharge the capacitor completely before conducting the repair work.**

- An charged capacitor can cause electrical shock.

**Do not use the product in a tightly closed space for a long time. Perform ventilation regularly.**

- Oxygen deficiency could occur and hence harm your health.

**Ventilate the product room from time to time when operating it together with a stove, or heating element etc.**

- Oxygen deficiency can occur and hence harm your health.

**Take care to ensure that nobody especially kids could step on or fall onto the outdoor unit.**

- This could result in personal injury and product damage.

**Do not plug or unplug the power supply plug to turn the unit ON/OFF .**

- There is risk of fire or electric shock.

**Safely dispose off the packing materials. Like screws, nails, batteries, broken things etc after installation or svc and then tear away and throw away the plastic packaging bags.**

- Children may play with them and cause injury.

**When installing the unit, use the installation kit provided with the product.**

- Otherwise the unit may fall and cause severe injury.

**Do not open the front grille of the product during operation. (Do not touch the electrostatic filter, if the unit is so equipped.)**

- There is risk of physical injury, electric shock, or product failure.

**Turn the main power off and unplug the unit when cleaning or repairing the product.**

- There is risk of electric shock.

**Take care to ensure that power cable could not be pulled out or damaged during operation.**

- There is risk of fire or electric shock.

**Make sure to check that the power cable plug is not dirty, loose or broken and then only insert the plug completely.**

- Dirty, loose or broken power plug can cause electric shock or fire.

**Be sure to use only those parts which are listed in the svc parts list. Never attempt to modify the equipment.**

- The use of inappropriate parts can cause an electrical shock, excessive heat generation or fire.

**If strange sounds, smell or smoke comes from product. Immediately turn the breaker off or disconnect the power supply cable.**

- There is risk of electric shock or fire.

**When the product is not to be used for a long time, disconnect the power supply plug or turn off the breaker.**

- There is risk of product damage or failure, or unintended operation.

**Do not place ANYTHING on the power cable.**

- There is risk of fire or electric shock.

**When flammable gas leaks, turn off the gas and open a window for ventilation before turn the product on.**

- Do not use the telephone or turn switches on or off. There is risk of explosion or fire.

---

## CAUTION

---

**Two or more people must lift and transport the product.**

- Avoid personal injury.

**Keep level even when installing the product.**

- To avoid vibration or noise.

**Do not install the product where it will be exposed to sea wind (salt spray) directly.**

- It may cause corrosion on the product.

**Do not install the product where the noise or hot air from the outdoor unit could damage or disturb the neighborhoods.**

- It may cause a problem for your neighbors and hence dispute.

**Install the drain hose to ensure that the condensed water is drained away properly.**

- A bad connection may cause water leakage.

**Always check for gas (refrigerant) leakage after installation or repair of product.**

- Low refrigerant levels may cause failure of product.

**Do not use the product for special purposes, such as preserving foods, works of art, etc. It is a consumer air conditioner, not a precision refrigeration system.**

- There is risk of damage or loss of property.

**Do not block the inlet or outlet of air flow.**

- It may cause product failure.

**Use a soft cloth to clean. Do not use harsh detergents, solvents or splashing water etc .**

- There is risk of fire, electric shock, or damage to the plastic parts of the product.

**Do not touch the metal parts of the product when removing the air filter.**

- There is risk of personal injury.

**Do not step on or put anything on the product. (outdoor units)**

- There is risk of personal injury and failure of product.

**Always insert the filter securely after cleaning. Clean the filter every two weeks or more often if necessary.**

- A dirty filter reduces the efficiency.

**Do not insert hands or other objects through the air inlet or outlet while the product is operating.**

- There are sharp and moving parts that could cause personal injury.

**Be cautious when unpacking and installing the product.**

- Sharp edges could cause injury.

**If the refrigerant gas leaks during the repair, do not touch the leaking refrigerant gas.**

- The refrigerant gas can cause frostbite (cold burn)

**Do not tilt the unit when removing or uninstalling it.**

- The condensed water inside can spill .

**Do not mix air or gas other than the specified refrigerant used in the system .**

- If air enters the refrigerant system, an excessively high pressure results, causing equipment damage or injury.

**If the refrigerant gas leaks during the installation, ventilate the area immediately.**

- Otherwise it can be harmful for your health.

**Dismantling the unit, treatment of the refrigerant oil and eventual parts should be done in accordance with local and national standards.**

**Replace the all batteries in the remote control with new ones of the same type. Do not mix old and new batteries or different types of batteries.**

- There is risk of fire or product failure.

**Do not recharge or disassemble the batteries. Do not dispose off batteries in a fire.**

- They may burn or explode.

**If the liquid from the batteries gets onto your skin or clothes, wash it well with clean water. Do not use the remote if the batteries have leaked.**

- The chemicals in batteries could cause burns or other health hazards.

**If you eat the liquid from the batteries, brush your teeth and see doctor. Do not use the remote if the batteries have leaked.**

- The chemicals in batteries could cause burns or other health hazard.

**Do not let the air conditioner run for a long time when the humidity is very high and a door or a window is left open.**

- Moisture may condense and wet or damage furniture.

**Do not expose your skin or kids or plants to the cool or hot air draft.**

- This could harm to your health.

**Do not drink the water drained from the product.**

- It is not sanitary and could cause serious health issues.

**Use a firm stool or ladder when cleaning, maintaining or repairing the product at an height.**

- Be careful and avoid personal injury.

# Product Introduction

## Name and function of parts

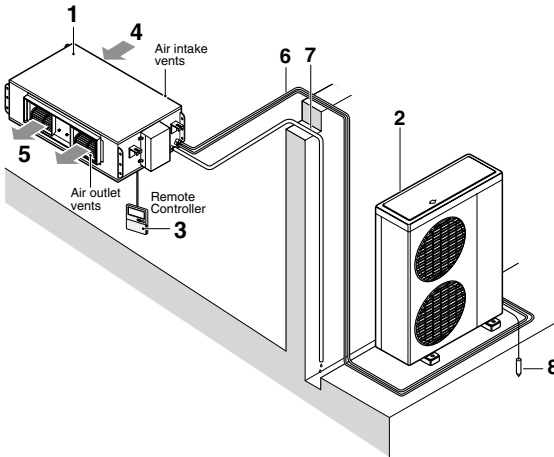

- 1: Indoor unit
- 2: Outdoor unit
- 3: Remote controller
- 4: Inlet air
- 5: Discharge air
- 6: Refrigerant piping, connection electric wire
- 7: Drain pipe
- 8: Ground wire  
wire to ground outdoor unit to prevent electrical shocks.

## What to do before operation

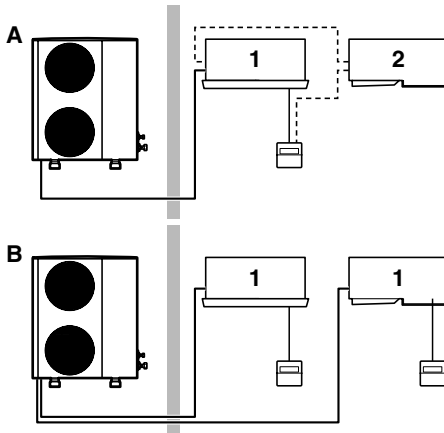

If your installation has a customized control system, ask your LG dealer for the operation that corresponds to your system.

- A: Pair system or simultaneous operation system
- B: Multi system
- 1: Unit with remote controller
- 2: Unit without remote controller (when used as simultaneous operation)

# Wired Remote Controller

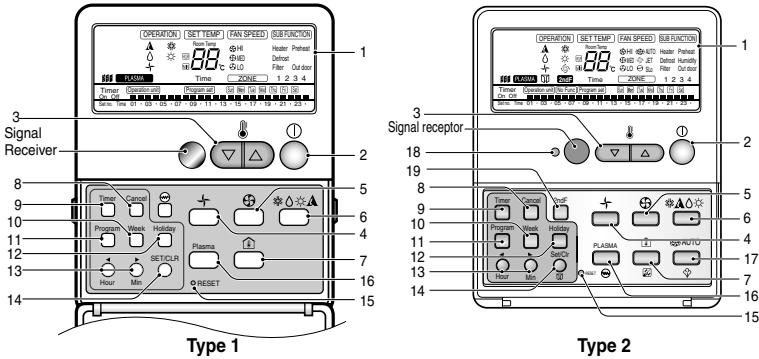

- 1. Operation display
- 2. On/Off Button
- 3. Set Temperature Button
- 4. FAN Operation Button
- 5. Fan Speed Button
- 6. Operation Mode Selection Button

- 7. Room Temperature Checking Button
- 8. Timer Cancel Button
- 9. Timer Set Button
- 10. Week Button
- 11. Program Button
- 12. Holiday Button
- 13. Time Set Button
- 14. Set and Clear Button
- 15. Reset Button
- 16. Plasma Button
- 17. Fan Auto Button
- 18. Operation Lamp
- 19. 2nd F Button

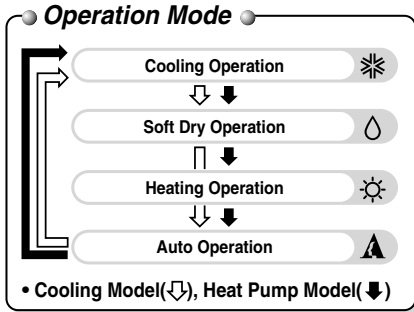

**NOTE**

- \* Display temperature can be different from actual room temperature if the remote controller is installed at the place where sun-rays are falling directly or the place nearby heat source.
- \* The actual product can be different from above contents depending upon model type.

# Operating Instructions

## Set the Current Time and day of the Week

Unless you press any button about 5 (sometimes 10) seconds while setting function, the setting mode returns to initial mode.

**1** Press the '  ' button.

Each time the button is pressed, the number is changed from *00* to *23*.  
You can set the number of the current hour.

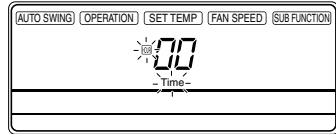
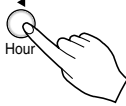

**2** Press the '  ' button.

Each time the button is pressed, the number is increased from *00* to *59*.  
You can set the number of the current minute.

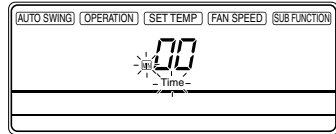
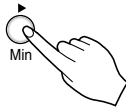

**3** Press '  ' button.

Each time the button is pressed, a day of the week is shifted from Sunday to Saturday.  
You can set the day of the week.

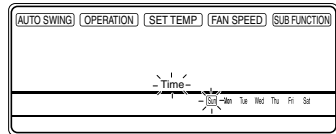

**4** Press the '  ' button.

If you want to reset the current time and a day of the week, click the Reset button.

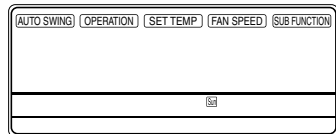

## Weekly Programming

- 1** Press the Program button.  
The remote controller display becomes as shown below. Then 'Program set', 'Set' and '01' is blinked.

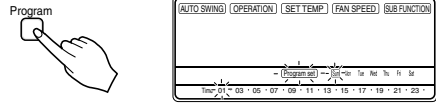

- 2** Press the 'Week' button.  
e.g. To select Thu, press the button 4 times

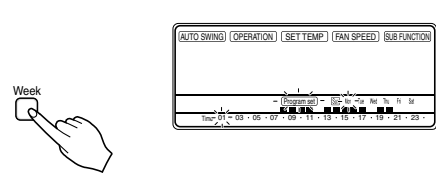

- 3** Select the time you want.  
If you press Hour or Min button, then indication part blinks to select On/Off hours  
If you press SET/CLR button at the selected hour, then indication part is stored as unit's On time.

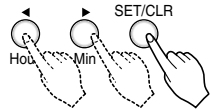

If you press it again, then that hour is skipped

For example: Over here, the unit is turned On at 6~8 & 13~22 hours and remains Off during rest of time. (Black Bar indicates On hour and no bar indicated Off hour interval)

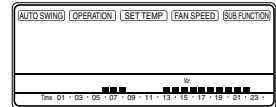

Similarly you can do the settings for rest of days of the week.

- 4** Press the Program button again to finish Weekly Programming.



- 5** The same setting continues following weeks unless you don't do setting again.  
If you want to keep the settings only for 1 week, follow the steps below

- 1) Press "CANCEL" & "SET/CLR" buttons simultaneously.  
Then the display becomes as shown in figure (A) below.

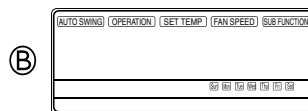
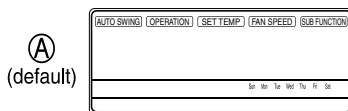

- 2) Detach your fingers when the display becomes as shown in figure (B) above.  
Now the weekly program is stored for one week only.

**NOTE** This function can not be applicable to some models.

# Holiday Setting

If Tuesday is a holiday in this week, you may set a holiday.

**1** Press the Program button.

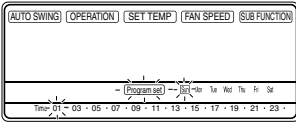
**2** Press the Week button.  
Select Tuesday.

**3** Press the Holiday button.

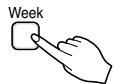
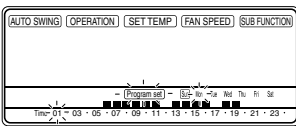

Then the remote controller will display 'Tue'.  
The outside rectangular means holiday.

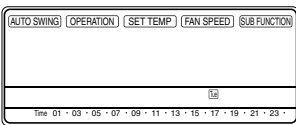

**NOTE** You cannot set the weekly program for a holiday.

**4** Press the Program button again to finish holiday setting.

# Timer Setting

This function is used to set either ON or Off interval once in 24 hrs since the setting was done. The unit will automatically operate as per the settings.

**1** Press the Timer button.

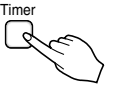

**2** Using Hour & Min buttons, change the timer setting until the desired time is set.

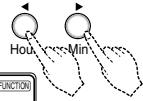

e.g. The unit is turned off after 5 hrs

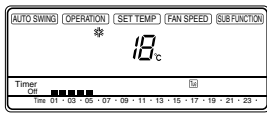

**3** If you want to cancel the timer setting, press the Timer button again.

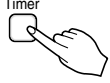

**NOTE** You can not set On Timer Setting and Off Timer Setting at the same time.

## Operation Mode

**1** Press the On/Off Button.

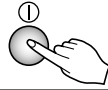

**2** Select the desired Operation.  
Press the Operation Mode Selection Button.

Each time the button is pressed, the operation mode is shifted as shown in the arrow direction.

### HEAT PUMP TYPE

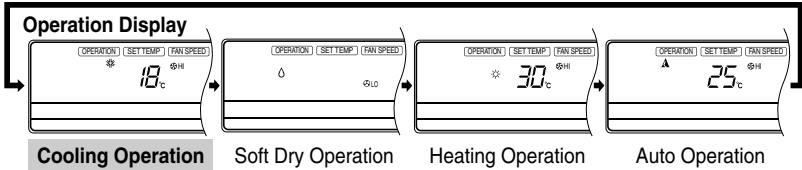

### COOLING TYPE

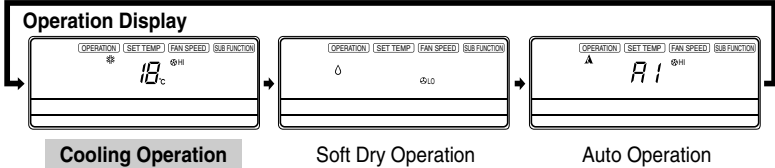

## Cooling/Heating Operation Mode

**3** Set the desired temperature.

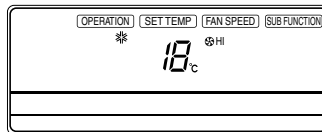

### Cooling Mode

Setting temperature range is 18~30 °C

### Heating Mode

Setting temperature range is 16~30°C

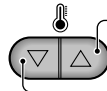

To raise the Temperature.

To lower the Temperature.

**4** Set the fan speed.

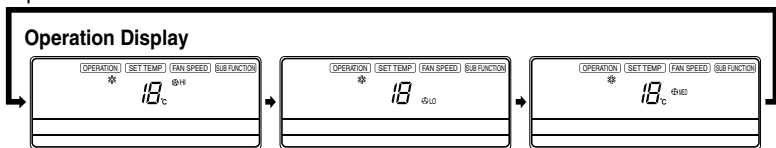

• Each time the button is pressed, the fan speed mode is shifted.

## For Heat Pump Type

**5** This air-conditioner is set to the hot start control in order not to discharge the cold air during the heating operation. This time, the remote controller indicates 'Preheat'.

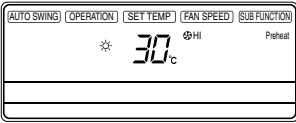

**6** If the outdoor temperature is too low during the heating operation, this air-conditioner is set to the defrosting operation and the remote controller indicates 'Defrost'.

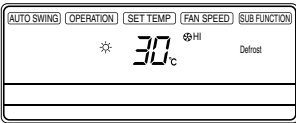

## Soft Dry Operation Mode

**7** Soft Dry Operation is used to remove the humidity softly without overcooling the room, specially when the humidity is already low. The indoor fan speed is automatically set to the low. But you can change it. Soft dry operation cancels and becomes the cooling operation if you press the operation mode selection button.

## Auto Operation Mode (Cooling Type)

**8** The temperature and fan speed are automatically set by the electronic controls based on the actual room temperature. If you want to change the set temperature, close the door on the remote control and press the Room Temperature Setting buttons. The cooler or warmer you feel, the more times (up to two times) you should press the button. The set temperature will then be changed. The temperature can be set within a range of -2~2 by 1 level.

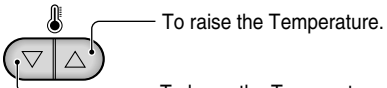
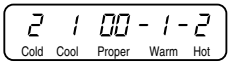
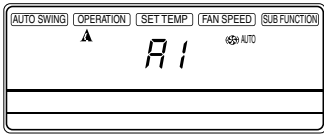

(This indication will be shifted to the initial Auto Mode Display state after 5 seconds.)

**During Auto Operation:**

- You cannot switch the indoor fan speed. It has already been set by the Fuzzy rule.
- If the system is not operating as desired, manually switch to another mode. The system will not automatically switch from the cooling mode to the heating mode, or from heating to cooling, it must be done by manually resetting.

## Auto Operation Mode (Heat Pump Type)

- 9** The setting temperature can be changed, when the set temperature button is pressed.

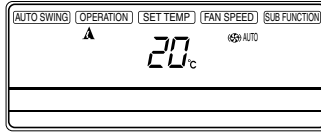

- The temperature can be set within a range of 18°C~30°C by 1°C.

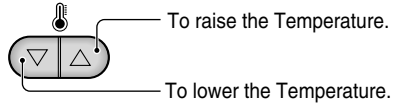

### Auto Change Over Operation(Pair system):

- You can switch the indoor fan speed.
- The system will automatically switch from the cooling mode to the heating mode, or from heating to cooling, when you select Auto Operation mode.

### Auto Operation(Multi system or Simultaneous system):

- You can switch the indoor fan speed.
- If the system is not operating as desired, manually switch to another mode. The system will not automatically switch from the cooling mode to the heating mode, or from heating to cooling, then you must set the mode and the desired temperature again.

## Fan Operation Mode

This function is used to circulate room air without cooling or heating.

- 1** Press the On/Off Button.



- 2** press FAN Operation Button.



- 3** Each time Fan Speed button is pressed, the fan speed mode is shifted as shown below.



## Fan Auto

Fan Auto function is used to control the airflow when outdoor unit is not working.

- 1 Press the Fan Auto button.  
Every time you press the Fan Auto button, it toggles between on and off.  
But for the models that do not support the Fan Auto function, the Fan Auto function will not work even though the sign will be shown on the screen.

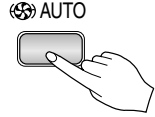

- 2 If Fan Auto function is On when outdoor unit is not working, Then the indoor fan will not operate.  
If Fan Auto function is Off when outdoor unit is not working, Then the indoor fan operates at Low speed or at the adjusted speed.

**NOTE** Fan Auto function is not applicable to some models.

## Auto Restarting Function

- 1 When the power has been shut off due to power failure or other reasons, it is automatically operated as previous operation condition with the power failure compensation function
- 2 In case of power failure condition, the remote controller display is off but the setting are retrieved after the power recovery.

## Child Lock Function

The Child Lock Function disables all the functions of the remote controller.

### Operation procedure

#### 1. To set the Child-Lock Function

Press the Timer button and Minute Set button for three seconds. Then the operation mode shift to child lock mode and it is displayed 'CL' in the operation display.

When you press any button in this time, the remote controller doesn't accept to any selected mode and the 'CL' is displayed in the remote controller for about three seconds. But the Room Temperature function is operated in spite of child lock mode.

#### 2. To cancel the Child-Lock Function

Repress the Timer button and Minute Set button for three seconds. Then the child-lock mode is cancelled and the preselected mode is displayed in the remote controller.

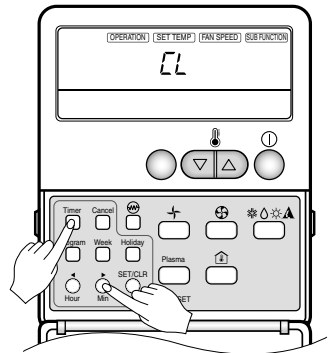

# Maintenance and Service

## Indoor Unit

### Grille, Case and Remote Control

□ Turn the system off before cleaning. To clean, wipe with a soft, dry cloth. Do not use bleach or abrasives.

#### NOTE

Supply power must be disconnected before cleaning the indoor unit.

## Air Filters

The air filters behind the front grille should be checked and cleaned once every 2 weeks or more often if necessary.

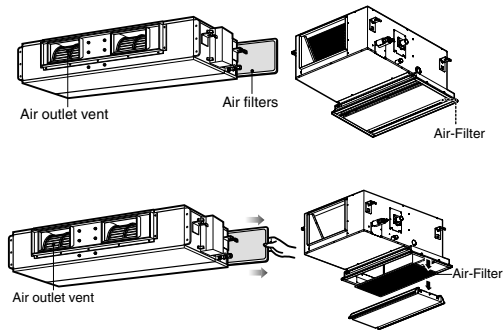

### 1 Remove the Air filters.

- Take hold of the tab and pull slightly forward to remove the filter.



**CAUTION:** When the air filter is to be removed, do not touch the metal parts of the indoor unit. It may cause an injury.

### 2 Clean dirt from the air filter using a vacuum cleaner or washing with water.

- If dirt is conspicuous, wash with a neutral detergent in lukewarm water.
- If hot water (50°C or more) is used, it may be deformed.

### 3 After washing with water, dry well in the shade.

- Do not expose the air filter to direct sunlight or heat from a fire when drying it.

### 4 Install the air filter.

#### ■ Never use any of the followings:

- Water hotter than 40°C.  
Could cause deformation and/or discoloration.
- Volatile substances.  
Could damage the surfaces of the air conditioner.



## Operation Tips!

### Do not overcool the room.

This is not good for the health and wastes electricity.

### Keep blinds or curtains closed.

Do not let direct sunshine enter the room when the air conditioner is in cooling operation.

### Make sure that the doors and windows are shut tight.

Avoid opening doors and windows as much as possible to keep the air conditioned air in the room.

### Clean the air filter regularly.

Blockages in the air filter reduce the airflow and lower air conditioned and dehumidifying effects. Clean at least once every two weeks.

### Ventilate the room occasionally.

Since windows are kept closed, it is a good idea to open them and ventilate the room from time to time.

## When the air conditioner is not going...

### When it is not going to be used for a long time.

- 1 Operate the air conditioner on Air circulation mode for 2 to 3 hours.
  - This will dry out the internal parts.
- 2 Turn off the circuit breaker.



**CAUTION: Turn off the circuit breaker when the air conditioner is not going to be used for a long time.**

**Dirt may collect and may cause a fire.**

3. Remove the batteries from the Remote Controller.

### When the air conditioner is to be used again.

- Check that the air inlet and outlet of the indoor/outdoor unit are not blocked.

## Helpful information

The air filters and your electric bill.

If the air filters become clogged with dust, the cooling capacity will drop, and 6% of the electricity used to operate the air conditioner will be wasted.

## Troubleshooting Tips! Save time and money!

Check the following points before requesting repairs or service.... If the malfunction persists, please contact your dealer.

Case	Explanation	See page
The air conditioner does not operate.	<ul style="list-style-type: none"> <li>• Have you made a mistake in timer operation?</li> <li>• On first starting, the indoor unit operates in fifteen seconds.</li> <li>• Has the fuse blown or has the circuit breaker been tripped?</li> </ul>	10
The room has a peculiar odor.	<ul style="list-style-type: none"> <li>• Check that this is not a damp smell exuded by the walls, carpet, furniture or cloth items in the room.</li> </ul>	-
It seems that condensate is leaking from the air Conditioner.	<ul style="list-style-type: none"> <li>• Condensation occurs when the airflow from the air conditioner cools the warm room air.</li> </ul>	-
Air conditioner does not operate for about 3 minutes when restart.	<ul style="list-style-type: none"> <li>• This is the protector of the mechanism.</li> <li>• Wait about three minutes and operation will begin.</li> </ul>	-
Does not cool or heat effectively.	<ul style="list-style-type: none"> <li>• Is the air filter dirty? See air filter cleaning instructions.</li> <li>• The room may have been very hot when the room air conditioner was first turned on. Allow time for it to cool down.</li> <li>• Has the setting temperature been set incorrectly?</li> <li>• Are the indoor unit's air inlet or outlet vents obstructed?</li> </ul>	15   11
The air conditioner operation is noisy.	<ul style="list-style-type: none"> <li>• For a noise that sounds like water flowing. -This is the sound of freon flowing inside the air conditioner unit.</li> <li>• For a noise that sounds like the compressed air releasing into atmosphere. -This is the sound of the dehumidifying water being processed inside the air conditioning unit.</li> </ul>	-
Crack sound is heard.	<ul style="list-style-type: none"> <li>• This sound is generated by the expansion/contraction of the inlet grille, etc. due to changes of temperature.</li> </ul>	-
Remote control display is faint, or no display at all.	<ul style="list-style-type: none"> <li>• Has the circuit breaker been tripped?</li> </ul>	-

## Call the service immediately in the following situations

1. Anything abnormal such as burning smell, loud noise etc. happen. Stop the unit and turn the breaker off. Never try to repair by yourself or restart the system in such cases.
2. Main power cord is too hot or damaged.
3. Error code is generated by self diagnosis.
4. Water leaks from indoor unit.
5. Any switch, breaker (safety, earth) or fuse fails to work properly

**User must carry routine checkup & cleaning to avoid unit's poor performance.  
In case of special situation, the job must be carried out by service person only**



