



ENGLISH

ESPAÑOL

PORTUGUESE

OWNER'S MANUAL

AIR CONDITIONER

Please read this manual carefully before operating your set and retain it for future reference.

TYPE : CEILING CASSETTE - 1WAY



P/NO : MFL68021502

www.lg.com

TIPS FOR SAVING ENERGY

Here are some tips that will help you minimize the power consumption when you use the air conditioner. You can use your air conditioner more efficiently by referring to the instructions below:

- Do not cool excessively indoors. This may be harmful for your health and may consume more electricity.
- Block sunlight with blinds or curtains while you are operating the air conditioner.
- Keep doors or windows closed tightly while you are operating the air conditioner.
- Adjust the direction of the air flow vertically or horizontally to circulate indoor air.
- Speed up the fan to cool or warm indoor air quickly, in a short period of time.
- Open windows regularly for ventilation as the indoor air quality may deteriorate if the air conditioner is used for many hours.
- Clean the air filter once every 2 weeks. Dust and impurities collected in the air filter may block the air flow or weaken the cooling / dehumidifying functions.

For your records

Staple your receipt to this page in case you need it to prove the date of purchase or for warranty purposes. Write the model number and the serial number here:

Model number : _____

Serial number : _____

You can find them on a label on the side of each unit.

Dealer's name : _____

Date of purchase : _____

IMPORTANT SAFETY INSTRUCTIONS

READ ALL INSTRUCTIONS BEFORE USING THE APPLIANCE.

Always comply with the following precautions to avoid dangerous situations and ensure peak performance of your product

WARNING

It can result in serious injury or death when the directions are ignored

CAUTION

It can result in minor injury or product damage when the directions are ignored

WARNING

- Installation or repairs made by unqualified persons can result in hazards to you and others.
- The product shall be installed according to the Wiring regulations of the corresponding country.
- The information contained in the manual is intended for use by a qualified service technician familiar with safety procedures and equipped with the proper tools and test instruments.
- Failure to carefully read and follow all instructions in this manual can result in equipment malfunction, property damage, personal injury and/or death.

Installation

- Do not use a defective or underrated circuit breaker. Use this appliance on a dedicated circuit. There is risk of fire or electric shock.
- For electrical work, contact the dealer, seller, a qualified electrician, or an Authorized Service Center. Do not disassemble or repair the product. There is risk of fire or electric shock.
- Always ground the product. There is risk of fire or electric shock.
- Install the panel and the cover of control box securely. There is risk of fire or electric shock.
- Always install a dedicated circuit and breaker. Improper wiring or installation may cause fire or electric shock
- Use the correctly rated breaker or fuse. There is risk of fire or electric shock.
- Do not modify or extend the power cable. There is risk of fire or electric shock.
- Do not install, remove, or re-install the unit by yourself (customer). There is risk of fire, electric shock, explosion, or injury.
- Be cautious when unpacking and installing the product. Sharp edges could cause injury. Be especially careful of the case edges and the fins on the condenser and evaporator.
- For installation, always contact the dealer or an Authorized Service Center. There is risk of fire, electric shock, explosion, or injury.
- Do not install the product on a defective installation stand. It may cause injury, accident, or damage to the product.
- Be sure the installation area does not deteriorate with age. If the base collapses, the air conditioner could fall with it, causing property damage, product failure, and personal injury.
- Do not let the air conditioner run for a long time when the humidity is very high and a door or a window is left open. Moisture may condense and wet or damage furniture.

Operation

- Take care to ensure that power cable could not be pulled out or damaged during operation. There is risk of fire or electric shock.
- Do not place anything on the power cable. There is risk of fire or electric shock.
- Do not plug or unplug the power supply plug during operation. There is risk of fire or electric shock.
- Do not touch(operate) the product with wet hands. There is risk of fire or electrical shock.
- Do not place a heater or other appliances near the power cable. There is risk of fire and electric shock.
- Do not allow water to run into electric parts. It may cause There is risk of fire, failure of the product, or electric shock.
- Do not store or use flammable gas or combustibles near the product. There is risk of fire or failure of product.
- Do not use the product in a tightly closed space for a long time. Oxygen deficiency could occur.
- When flammable gas leaks, turn off the gas and open a window for ventilation before turn the product on. Do not use the telephone or turn switches on or off. There is risk of explosion or fire
- If strange sounds, or small or smoke comes from product. Turn the breaker off or disconnect the power supply cable. There is risk of electric shock or fire.
- Stop operation and close the window in storm or hurricane. If possible, remove the product from the window before the hurricane arrives. There is risk of property damage, failure of product, or electric shock.
- Do not open the inlet grill of the product during operation.(Do not touch the electrostatic filter, if the unit is so equipped.) There is risk of physical injury, electric shock, or product failure.
- When the product is soaked (flooded or submerged), contact an Authorized Service Center. There is risk of fire or electric shock.
- Be cautious that water could not enter the product. There is risk of fire, electric shock, or product damage.
- Ventilate the product from time to time when operating it together with a stove, etc. There is risk of fire or electric shock.
- Turn the main power off when cleaning or maintaining the product. There is risk of electric shock.
- When the product is not be used for a long time, disconnect the power supply plug or turn off the breaker. There is risk of product damage or failure, or unintended operation.
- Take care to ensure that nobody could step on or fall onto the outdoor unit. This could result in personal injury and product damage.



CAUTION

Installation

- Always check for gas (refrigerant) leakage after installation or repair of product. Low refrigerant levels may cause failure of product.
- Install the drain hose to ensure that water is drained away properly. A bad connection may cause water leakage.
- Keep level even when installing the product. To avoid vibration or water leakage.
- Do not install the product where the noise or hot air from the outdoor unit could damage the neighborhoods. It may cause a problem for your neighbors.
- Use two or more people to lift and transport the product. Avoid personal injury.

- Do not install the product where it will be exposed to sea wind (salt spray) directly. It may cause corrosion on the product. Corrosion, particularly on the condenser and evaporator fins, could cause product malfunction or inefficient operation.

Operation

- Do not expose the skin directly to cool air for long periods of time. (Don't sit in the draft.) This could harm to your health.
- Do not use the product for special purposes, such as preserving foods, works of art, etc. It is a consumer air conditioner, not a precision refrigeration system. There is risk of damage or loss of property.
- Do not block the inlet or outlet of air flow. It may cause product failure.
- Use a soft cloth to clean. Do not use harsh detergents, solvents, etc. There is risk of fire, electric shock, or damage to the plastic parts of the product.
- Do not touch the metal parts of the product when removing the air filter. They are very sharp! There is risk of personal injury.
- Do not step on or put anything on the product. (outdoor units) There is risk of personal injury and failure of product.
- Always insert the filter securely. Clean the filter every two weeks or more often if necessary. A dirty filter reduces the efficiency of the air conditioner and could cause product malfunction or damage.
- Do not insert hands or other objects through the air inlet or outlet while the product is operated. There are sharp and moving parts that could cause personal injury.
- Do not drink the water drained from the product. It is not sanitary and could cause serious health issues.
- Use a firm stool or ladder when cleaning or maintaining the product. Be careful and avoid personal injury.
- Replace the all batteries in the remote control with new ones of the same type. Do not mix old and new batteries or different types of batteries. There is risk of fire or explosion
- Do not recharge or disassemble the batteries. Do not dispose of batteries in a fire. They may burn or explode.
- If the liquid from the batteries gets onto your skin or clothes, wash it well with clean water. Do not use the remote if the batteries have leaked. The chemicals in batteries could cause burns or other health hazards.
- If you eat the liquid from the batteries, brush your teeth and see doctor. Do not use the remote if the batteries have leaked. The chemicals in batteries could cause burns or other health hazards.



Batteries :

Do not burn, do not try to open it, do not dispose in ordinary trash. Preserve environment and your health.

After use, batteries must be delivered to the merchant or service authorized network (Conama number 401 dated 11/2008).

TABLE OF CONTENTS

2 TIPS FOR SAVING ENERGY

3 IMPORTANT SAFETY INSTRUCTIONS

7 BEFORE USE

- 7 Preparing for operation
- 7 Usage
- 7 Cleaning and maintenance
- 7 Service

8 PRODUCT INTRODUCTION

- 8 Wireless Remote Controller

10 OPERATING INSTRUCTION

- 10 How to insert the Batteries
- 10 Wireless Remote Controller Maintenance

11 INSTALLATION INSTRUCTIONS

- 11 Installer Setting - How to enter installer setting mode
- 12 Installer Setting - Installer Setting Code Table
- 13 Installer Setting - Setting Address of Central Control
- 13 Installer Setting - Checking Address of Central Control

14 OWNER'S INSTRUCTION

- 14 Cooling Mode -Standard Operation
- 14 Cooling Mode - Power Cooling
- 15 Auto Operation Mode
- 16 Dehumidification Mode
- 17 Fan Mode
- 18 Temperature Setting/
Room Temperature checking
- 19 Airflow Setting
- 20 Plasma Purification(Optional)
- 20 Celsius/Fahrenheit Switching
- 21 Individual vane angle control
- 22 Timer

23 MAINTENANCE AND SERVICE

- 23 Indoor Unit
- 24 Operation Tips!
- 24 When the air conditioner is not going....
- 25 Troubleshooting Tips! Save time and money!
- 25 Call the service immediately in the following situations

BEFORE USE

Preparing for operation

- Contact an installation specialist for installation.
- Use a dedicated circuit.

Usage

- Being exposed to direct airflow for an extended period of time could be hazardous to your health. Do not expose occupants, pets, or plants to direct airflow for extended periods of time.
- Due to the possibility of oxygen deficiency, ventilate the room when used together with stoves or other heating devices.
- Do not use this air conditioner for non-specified special purposes (e.g. preserving precision devices, food, pets, plants, and art objects). Such usage could damage the items.

Cleaning and maintenance

- Do not touch the metal parts of the unit when removing the filter. Injuries can occur when handling sharp metal edges.
- Do not use water to clean inside the air conditioner. Exposure to water can destroy the insulation, leading to possible electric shock.
- When cleaning the unit, first make sure that the power and breaker are turned off. The fan rotates at a very high speed during operation. There is a possibility of injury if the unit's power is accidentally triggered on while cleaning inner parts of the unit.

Service

For repair and maintenance, contact your authorized service dealer.

PRODUCT INTRODUCTION

Wireless Remote Controller

This air-conditioner is equipped with wireless remote controller basically. But if you want to be available with wired remote controller, you pay for it.

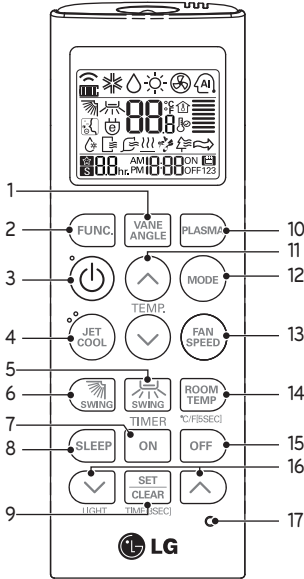

- 1 VANE ANGLE Button
Used to set each vane angle.
- 2 FUNCTION SETTING Button
Used to set or clear Auto Clean, Smart Clean, Electric heater or Individual vane angle control.
- 3 ON/OFF Button
Used to turn on/off the unit.
- 4 JET COOL Button
Speed cooling operates super high fan speed.
- 5 LEFT/RIGHT AIRFLOW Button (OPTIONAL)
Used to set the desired left/right(horizontal) airflow direction.
- 6 UP/DOWN AIRFLOW Button
Used to stop or start louver movement and set the desired up/down airflow direction.
- 7 ON TIMER Button
Used to set the time of starting operation.
- 8 SLEEP TIMER Button
Used to set the time of sleeping operation.
- 9 SET / CLEAR Button
Used to set/clear the timer.
Used to set the current time(if it input for 3sec.)
- 10 PLASMA Button (OPTIONAL)
Used to start or stop the plasma-purification function.
- 11 ROOM TEMPERATURE SETTING Button
Used to select the room temperature.
- 12 OPERATION MODE SELECTION Button
Used to select the operation mode.
- 13 INDOOR FAN SPEED SELECTION Button
Used to select fan speed in four steps low, medium, high and chaos.
- 14 ROOM TEMPERATURE CHECKING Button
Used to check the room temperature.
- 15 OFF TIMER Button
Used to set the time of stopping operation.
- 16 TIMER SETTING(Up/Down)/LIGHT Button
Used to set the timer.
Used to adjust the brightness.(if it is not time adjust mode)
- 17 RESET Button
Used to reset the remote controller.

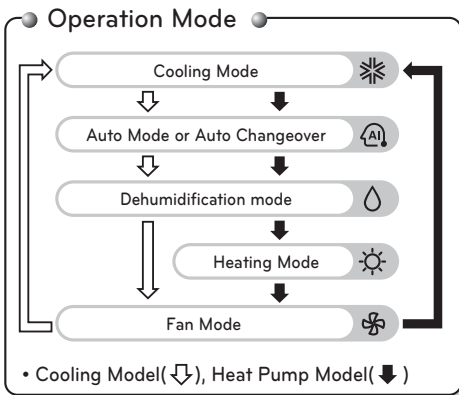

**CAUTION****Caution of handling the Remote Controller**

- Aim at the signal receiver on the wired remote controller so as to operate.
- The remote control signal can be received at a distance of up to about 7m.
- Be sure that there are no obstructions between the remote controller and the signal receptor.
- Do not drop or throw the remote controller.
- Do not place the remote controller in a location exposed to direct sunlight, or near the heating unit, or any other heat source.
- Block a strong light over the signal receptor with a curtain or etc. so as to prevent the abnormal operation. (ex:electronic quick start, ELBA, inverter type fluorescent lamp)

**NOTE**

- The wireless remote controller do not operate the swirl mode.(4Way Type)
- For more details refer to the Wireless Remote Control Accessory manual.
- The actual product can be different from above contents depending upon model type.

OPERATING INSTRUCTION

How to insert the Batteries

Remove the battery cover by pulling it according to the arrow direction.

Insert new batteries making sure that the (+) and (-) of battery are installed correctly.

Reattach the cover by sliding it back into position.

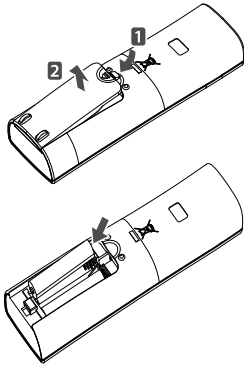

! NOTE

- Always use/replace both batteries of same type.
- If the system is not to be used for a long time, remove the batteries to save their working life.
- If the display screen of remote controller starts, fading replace both of the batteries.

Wireless Remote Controller Maintenance

Choose a suitable place where its safe & easy to reach.

Fix the holder to wall etc with the supplied screws firmly.

Slide the remote controller inside the holder.

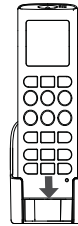
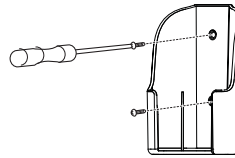

! NOTE

- Remote controller should never be exposed to direct sunlight.
- Signal transmitter & receiver should always be clean for proper communication. Use a soft cloth to clean them.
- In case some other appliances also get operated with remote control, change their position or consult your service-man.

INSTALLATION INSTRUCTIONS

Installer Setting - How to enter installer setting mode

⚠ CAUTION

Installer setting mode is to set the detail function of the remote controller. If the installer setting mode is not set correctly, it can cause problems to the product, user injury or property damage. This must be set by an certificated installer, and any installation or change that is carried out by a non-certificated person should be responsible for the results. In this case, free service cannot be provided.

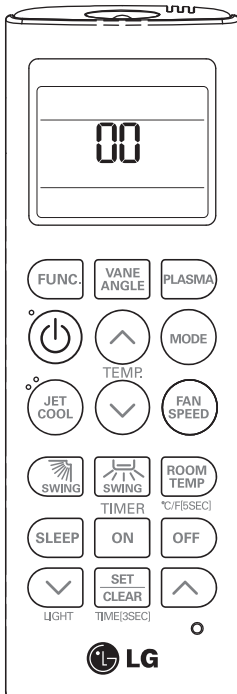

- 1 With the JET COOL button pressed, press the RESET button.
- 2 By using the TEMPERATURE SETTING button, set function code and setting value. (Please refer the Installer Setting Code Table.)
- 3 Press the ON/OFF button toward the indoor unit 1 time.
- 4 Reset the remote controller to use the general operation mode.

Refer to the Installer Setting Code Table on the next page.

Installer Setting - Installer Setting Code Table

Installer Setting Code Table

No.	Function	Function Code	Setting Value	Remote Controller LCD
0	Mode Override	0	0 : Set to Master	0.0
			1 : Set to Slave	0.1
1	Ceiling Height Selection	1	1 : Standard	1.1
			2 : Low	1.2
			3 : High	1.3
			4 : Super High	1.4
2	Group Control	2	0 : Set to Master	2.0
			1 : Set to Slave	2.1
			2 : Check Master/Slave	2.2
	Auxiliary heater	2	3 : Set to Auxiliary heater	2.3
			4 : Cancel Auxiliary heater	2.4
			5 : Check Auxiliary heater Installation	2.5

Mode Override

This Function is only for Non-Auto Changeover H/P model.

Ceiling Height Selection

Our products provide variety of air volumes and capacities according to the selection of ceiling heights.

Cooling/Heating performance is enhanced with relation to ceiling height.

- The highest/cooling heating performance and efficiency are provide at super high.

(Some noise may be generated according to the level height setting.)

Group Control

This function is only for group control. Please don't set this function in case of non-group control.

After setting Group Control of the product, turn off the power then turn it back on after 1 minute.

Auxiliary heater

This function is only applied to models with Auxiliary Heater function being activated.

Installer Setting - Setting Address of Central Control

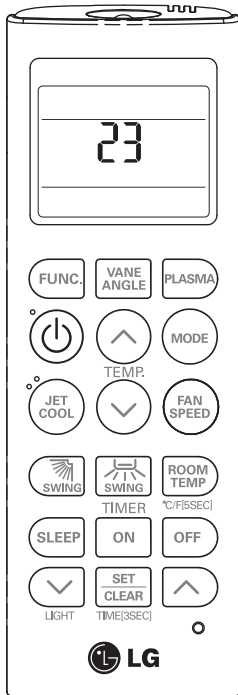

- 1 With the MODE button pressed, press the RESET button.
- 2 By using the temperature setting button, set the indoor unit address.
 - Setting range : 00 ~ FF
- 3 After setting the address, press the ON/OFF button toward the indoor unit 1 time.
- 4 The indoor unit will display the set address to complete the address setting.
 - The address display time and method can differ by the indoor unit type.
- 5 Reset the remote controller to use the general operation mode.

Installer Setting - Checking Address of Central Control

- 1 With the FUNC. button pressed, press the RESET button.
- 2 Press the ON/OFF button toward the indoor unit 1 time, and the indoor unit will display the set address in the display window.
 - The address display time and method can differ by the indoor unit type.
- 3 Reset the remote controller to use the general operation mode.

OWNER'S INSTRUCTION

Cooling Mode - Standard Operation

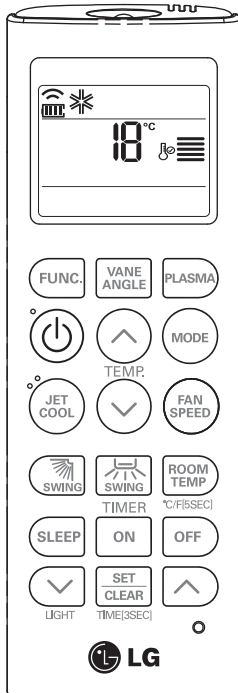

Cooling Mode - Power Cooling

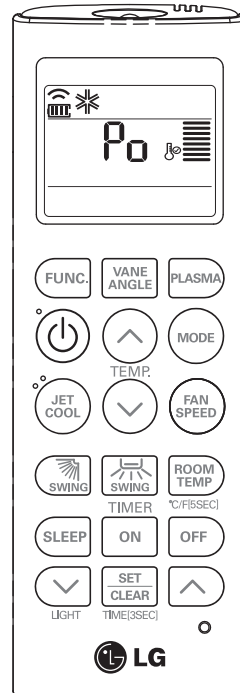

- 1 Press the ON/OFF button.
The unit will respond with beep sound.
- 2 Press MODE button to select Cooling Mode.
- 3 Set the desired temperature by pressing TEMP button.
Press ROOM TEMPERATURE CHECKING button to check the room temperature.
When setting the desired temperature is higher than room temperature, cooling wind isn't blow out.
- Setting Temp. Range : 18~30°C(64~86°F)

- 1 Press the ON/OFF button.
The unit will respond with beep sound.
- 2 Press MODE button to select Cooling Mode.
- 3 Press the JET COOL button. The unit will operate in super high fan speed in cooling mode.
- Wall mounted models operate power cooling mode for 30 minutes.
- 4 To cancel the Power cooling Mode press the Jet Cool button or the fan button or the room temperature setting button again and the unit will operate in high fan speed in cooling mode.

Auto Operation Mode

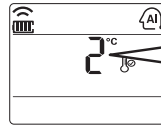
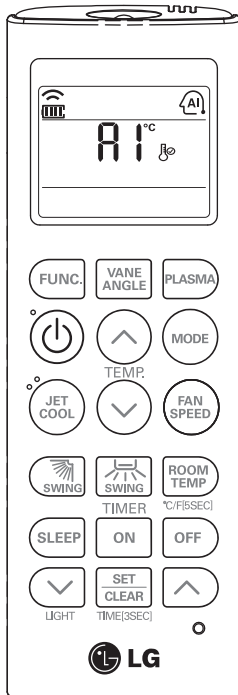

* Please select the code depend on your feeling.

Code	Feel
2	Cold
1	Slightly cool
0	Neutral
-1	Slightly warm
-2	Warm

During Auto Operation Mode

- If the system is not operating as desired, manually switch to another mode. The system will not automatically switch from the cooling mode to the heating mode, or from heating to cooling, then you must set the mode and the desired temperature again.

- 1 Press the ON/OFF button.
The unit will respond with beep sound.
- 2 Press MODE button to select Auto Operation Mode.
- 3 Set the desired temperature.

<For Cooling Model>

The temperature and fan speed are automatically set by the electronic controls based on the actual room temperature. If you feel hot or cold, press TEMPERATURE SETTING buttons for more cooling or heating effect.

You cannot switch the indoor fan speed. It has already been set by the Auto Operation Mode rule.

Dehumidification Mode

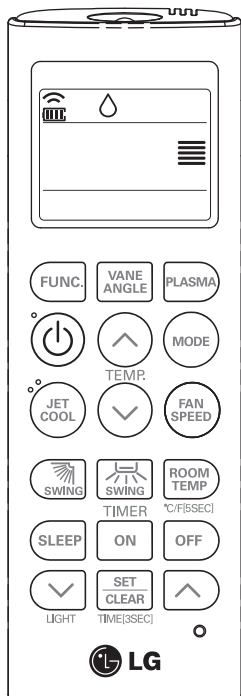

During Dehumidification Mode

- If you select the dehumidification mode on the operation selection button, the indoor unit starts to run the dehumidification function, automatically setting the room temp. and air volume to the best condition for dehumidification based on the sensed room temp. In this case, the setting temp. is not displayed in the Remote Controller and you are not able to control the room temp. either.
- During the healthy dehumidification function, the air volume is automatically set according to the algorithm responding to the current room temp. and makes the room condition healthy and comfortable even in the high humidity season.

- 1 Press the ON/OFF button.
The unit will respond with beep sound.
- 2 Press MODE button to select Dehumidification Mode.
- 3 Set the fan speed. You can select the fan speed in four steps - low, medium, high, or chaos. Each time the button is pressed, the fan speed mode is shifted.

Fan Mode

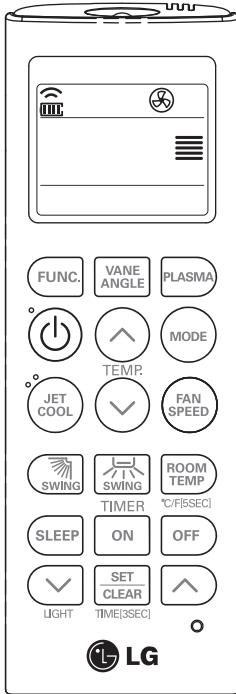

Natural Wind by the chaos Logic

- For more fresh feeling than other fan speed, press the Indoor Fan Speed Selector and set to chaos mode. In this mode, the wind blows like natural breeze by automatically changing fan speed according to the chaos logic.

During Fan Mode

- The outdoor compressor doesn't work. Have a function to circulate the indoor as it sends out the air that doesn't have much temperature difference with indoor.

- 1 Press the ON/OFF button.
The unit will respond with beep sound.
- 2 Press MODE button to select Fan Mode.
- 3 Set the fan speed again. You can select the fan speed in four steps—low, medium, high, or chaos. Each time the button is pressed, the fan speed mode is shifted.

Temperature Setting/Room Temperature checking

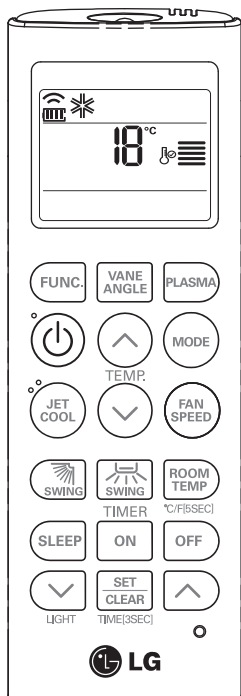

We can simply adjust the desired temperature

- Press the buttons to adjust the desired temperature



: Increase 1°C or 1°F per one time pressing



: Decrease 1°C or 1°F per one time pressing

Room temp: Indicate the current room temperature

Set temp: Indicate the temperature that user want to set

<Cooling Mode>

The cooling mode doesn't work if desired temperature is higher than room temperature. Please lower the desired temperature.

<Heating Mode>

The heating mode doesn't work if desired temperature is lower than room temperature. Please increase the desired temperature.

Whenever press  button, the room temperature will be displayed within 5 seconds.

After 5 seconds, it turns to display the desired temperature.

Because of location of remote controller, the real room temperature and the this displayed value can be different.

Airflow Setting

Up/Down Airflow Direction Control (Optional)

The up/down airflow (Vertical Airflow) can be adjusted by using the remote controller.

- 1 Press the ON/OFF button to start the unit.
- 2 Press up/down airflow button and the louvers will swing up and down. Press the up/down airflow button again to set the vertical louver at the desired airflow direction.

NOTE

- If you press the UP/DOWN AIRFLOW button, the horizontal airflow direction is changed automatically based on the Auto Swing algorithm to distribute the air in the room evenly and at the same time to make the human body feel more comfortable, as if enjoying a natural breeze.
- Always use the remote controller to adjust the up/down airflow direction. Manually moving the vertical airflow direction louver by hand, could damage the air conditioner.
- When the unit is shut off, the up/down airflow direction louver will close the air outlet vent of the system.

Left/Right Airflow Direction Control (Optional)

The left/right(horizontal) airflow can be adjusted by using the remote control.

- 1 Press the ON/OFF button to start the unit.
- 2 Press the LEFT/RIGHT AIRFLOW button and the louvers will swing left and right. Press the Horizontal Airflow Direction Control Button again to set the horizontal louver at the desired airflow direction.

- Up/Down and Left/Right Airflow function isn't shown on display of remote controller.

Plasma Purification(Optional)

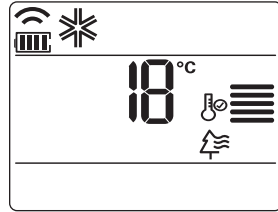
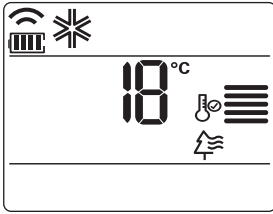

- 1 Press the ON/OFF button.
The unit will respond with beep sound.
- 2 Press the PLASMA button. Plasma Purification will start when the button is pressed and stop when the button is pressed again.

If you press the PLASMA button, Plasma Purification operates.

- Plasma filter is a technology developed by LG to get rid of microscopic contaminants in the intake air generating a plasma of high charge electrons. This plasma kills and destroys the contaminants completely to provide clean and hygienic air.
- This function can be used in any operation mode and any fan speed can be used while plasma filter is functioning.

Celsius/Fahrenheit Switching

Press the °C/°F SWITCH button to change from Celsius to Fahrenheit or from Fahrenheit to Celsius.

Whenever press TEMPERATURE SETTING button in Fahrenheit mode, the temperature will increase/drop 1°F.

Individual vane angle control

It is the function that can control 4 vane angles individually in the ceiling type 4Way cassette product group.

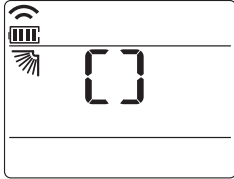

- 1 Press the VANE ANGLE button. Individual vane angle control symbol will blink.
 - If you press the VANE ANGLE button for 3 seconds in that time, all vanes are set to standard angle.

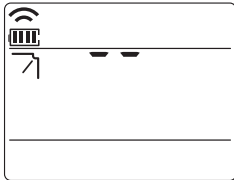

- 2 Set each vane angle by pressing the VANE ANGLE button.
 - Every time the button is pressed, corresponding vane angle and set values are displayed.
 - When up direction button is pressed, the display window appears as of the figure in the right, and the angle can be set to 1~6.
 - Multi-V Console products can be controlled by up key in the up/down control.

3. Press SET/CLEAR button to reserve or cancel the individual vane angle control function.

- There may be differences between wireless remote controller up/down/left/right buttons and the wind discharge port directions.
- Set desired angle with checking the vane angle movement of the product.
- The individual vane control function is an additional function of a product, and it may not work in some products.

Timer

Setting the Current Time

- 1 Press the SET/CLEAR button for 3 seconds.
- 2 Press TIME SETTING buttons until the desired time is set.
- 3 Press the SET / CLEAR button.

! NOTE

Check the indicator for A.M. and P.M.

Timer Setting

- 1 Press the TIMER button to turn timer on or off.
- 2 Press TIME SETTING buttons until the desired time is set.
- 3 Press the SET / CLEAR button.

! NOTE

Select one of the following 3 types of operation.

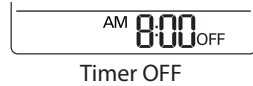
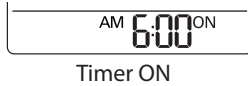
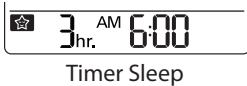

To cancel the Timer Setting

- If you wish to cancel all timer setting, press the SET/CLEAR button.
- If you wish to cancel each timer setting, press the TIMER button to turn timer sleep or on or off as you want.
And then press the SET/CLEAR button aiming the remote controller at the signal receptor.
(The timer lamp on the air conditioner and the display will go off.)

MAINTENANCE AND SERVICE

Indoor Unit

Grille, Case and Remote Control

- Turn the system off before cleaning. To clean, wipe with a soft, dry cloth. Do not use bleach or abrasives.

! NOTE

Supply power must be disconnected before cleaning the indoor unit.

Air Filters

The air filters behind the front grille should be checked and cleaned once every 2 weeks or more often if necessary.

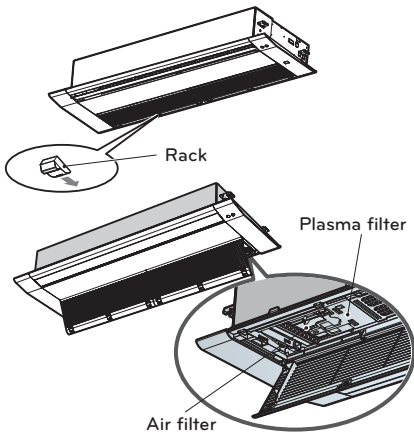

- Never use any of the followings:
Water hotter than 40°C.
Could cause deformation and/or discoloration.
Volatile substances.
Could damage the surfaces of the air conditioner.



- Remove the Air filters.
Take hold of the tab and pull slightly forward to remove the filter.

! CAUTION

When the air filter is to be removed, do not touch the metal parts of the indoor unit.
It may cause an injury.

- Clean dirt from the air filter using a vacuum cleaner or washing with water.
If dirt is conspicuous, wash with a neutral detergent in lukewarm water.
If hot water (50°C or more) is used, it may be deformed.
- After washing with water, dry well in the shade.
Do not expose the air filter to direct sunlight or heat from a fire when drying it.
- Install the air filter.

Operation Tips!

<p>Do not overcool the room. This is not good for the health and wastes electricity.</p>	<p>Keep blinds or curtains closed. Do not let direct sunshine enter the room when the air conditioner is in operation.</p>	<p>Keep the room temperature uniform. Adjust the vertical and horizontal airflow direction to ensure a uniform temperature in the room.</p>
<p>Make sure that the doors and windows are shut tight. Avoid opening doors and windows as much as possible to keep the cool air in the room.</p>	<p>Clean the air filter regularly. Blockages in the air filter reduce the airflow and lower cooling and dehumidifying effects. Clean at least once every two weeks.</p>	<p>Ventilate the room occasionally. Since windows are kept closed, it is a good idea to open them and ventilate the room now and then.</p>

When the air conditioner is not going....

When air conditioner is not going to be used for a long time.

- Operate the air conditioner at the following settings for 2 to 3 hours.
Type of operation: Fan operation mode. (Refer to page 19.)
This will dry out the internal mechanisms.
- Turn off the breaker.



CAUTION

Turn off the breaker when the air conditioner is not going to be used for a long time.
Dirt may collect and may cause a fire.

- Remove the batteries from the Remote Controller.

Helpful information

The air filters and your electric bill.

If the air filters become clogged with dust, the cooling capacity will drop, and 6% of the electricity used to operate the air conditioner will be wasted.

When the air conditioner is to be used again.

- Clean the air filter and install it in the indoor unit. (Refer to page 25 for cleaning it.)
- Check that the air inlet and outlet of the indoor/outdoor unit are not blocked.
- Check that the ground wire is connected correctly. It may be connected to the indoor unit side.

Troubleshooting Tips! Save time and money!

Check the following points before requesting repairs or service.... If the malfunction persist, please contact your dealer.

<p>The air conditioner does not operate.</p> <ul style="list-style-type: none"> - Have you made a mistake in timer operation? - Has the fuse blown or has the circuit breaker been tripped? 	<p>The room has a peculiar odor.</p> <ul style="list-style-type: none"> - Check that this is not a damp smell exuded by the walls, carpet, furniture or cloth items in the room. 	<p>It seems that condensation is leaking from the air conditioner.</p> <ul style="list-style-type: none"> - Condensation occurs when the airflow from the air conditioner cools the warm room air. 	<p>Air conditioner does not operate for about 3 minutes when restart.</p> <ul style="list-style-type: none"> - This is the protector of the mechanism. - Wait about three minutes and operation will begin.
<p>Does not cool or heat effectively.</p> <ul style="list-style-type: none"> - Is the air filter dirty? See air filter cleaning instructions. - The room may have been very hot when the room air conditioner was first turned on. Allow time for it to cool down. - Has the temperature been set incorrectly? - Are the indoor unit's air inlet or outlet vents obstructed? 	<p>The air conditioner operation is noisy.</p> <ul style="list-style-type: none"> - For a noise that sounds like water flowing. <ul style="list-style-type: none"> * This is the sound of freon flowing inside the air conditioner unit. - For a noise that sounds like the compressed air releasing into atmosphere. - This is the sound of the dehumidifying water being processed inside the air conditioning unit. 	<p>Crack sound is heard.</p> <ul style="list-style-type: none"> - This sound is generated by the expansion/ constriction of the front panel, etc. due to changes of temperature. <p>Filter sign lamp (LED) is ON.</p> <ul style="list-style-type: none"> - Cleaning the filter, press the Timer button and ◀ button of wired remote controller at the same time for 3 sec. 	<p>Remote control display is faint, or no display at all.</p> <ul style="list-style-type: none"> - Are the batteries depleted? - Are the batteries inserted in the opposite (+) and (-) directions?

Call the service immediately in the following situations

- Anything abnormal such as burning smell, loud noise etc. happen. Stop the unit and turn the breaker off. Never try to repair by yourself or restart the system in such cases.
- Main power cord is too hot or damaged.
- Error code is generated by self diagnosis.
- Water leaks from indoor unit even if the humidity is low.
- Any switch, breaker (safety, earth) or fuse fails to work properly

User must carry routine checkup & cleaning to avoid unit's poor performance.
In case of special situation, the job must be carried out by service person only.

