

OWNER'S MANUAL AIR CONDITIONER

Please read this manual carefully before operating your set and retain it for future reference.

TYPE : WALL MOUNTED



P/NO : MFL68025002

www.lg.com

TIPS FOR SAVING ENERGY

Here are some tips that will help you minimize the power consumption when you use the air conditioner. You can use your air conditioner more efficiently by referring to the instructions below:

- Do not cool excessively indoors. This may be harmful for your health and may consume more electricity.
- Block sunlight with blinds or curtains while you are operating the air conditioner.
- Keep doors or windows closed tightly while you are operating the air conditioner.
- Adjust the direction of the air flow vertically or horizontally to circulate indoor air.
- Speed up the fan to cool or warm indoor air quickly, in a short period of time.
- Open windows regularly for ventilation as the indoor air quality may deteriorate if the air conditioner is used for many hours.
- Clean the air filter once every 2 weeks. Dust and impurities collected in the air filter may block the air flow or weaken the cooling / dehumidifying functions.

For your records

Staple your receipt to this page in case you need it to prove the date of purchase or for warranty purposes. Write the model number and the serial number here:

Model number : _____

Serial number : _____

You can find them on a label on the side of each unit.

Dealer's name : _____

Date of purchase : _____

IMPORTANT SAFETY INSTRUCTIONS

READ ALL INSTRUCTIONS BEFORE USING THE APPLIANCE.

Always comply with the following precautions to avoid dangerous situations and ensure peak performance of your product

WARNING

It can result in serious injury or death when the directions are ignored

CAUTION

It can result in minor injury or product damage when the directions are ignored

WARNING

- Always use a power plug and socket with a ground terminal. There is a risk of electric shock.
- Do not use a defective or underrated circuit breaker. Use the correctly rated breaker and fuse. There is risk of fire or electric shock .
- Do not use a multi consent. Always use this appliance on a dedicated circuit breaker. Otherwise it can cause electric shock or fire.
- For electrical work, contact the dealer, seller, a qualified electrician, or an Authorized Service Center. Do not disassemble or repair the product by yourself. There is risk of fire or electric shock.
- Always ground the product as per the wiring diagram. Do not connect the ground wire to gas or water pipes lightning rod or telephone ground wire. There is risk of fire or electric shock.
- Install the panel and the cover of control box securely. There is risk of fire or electric shock due to dust , water etc.
- Use the correctly rated breaker or fuse. There is risk of fire or electric shock.
- Do not modify or extend the power cable. If the power cable or cord has scratches or skin peeled off or deteriorated then it must be replaced. There is risk of fire or electric shock.
- For installation, removal or reinstall , always contact the dealer or an Authorized Service Center. There is risk of fire, electric shock, explosion, or injury.
- Do not install the product on a defective installation stand. Be sure that the installation area does not deteriorate with age. It may cause product to fall.
- Never install the outdoor unit on a moving base or a place from where it can fall down. The falling outdoor unit can cause damage or injury or even death of a person.
- When the product is soaked (flooded or submerged) in water , contact an Authorized Service Center for repair before using it again. There is risk of fire or electric shock.
- In outdoor unit the step-up capacitor supplies high voltage electricity to the electrical components. Be sure to discharge the capacitor completely before conducting the repair work. An charged capacitor can cause electrical shock.
- When installing the unit, use the installation kit provided with the product. Otherwise the unit may fall and cause severe injury.
- Be sure to use only those parts which are listed in the svc parts list. Never attempt to modify the equipment. The use of inappropriate parts can cause an electrical shock, excessive heat generation or fire.

4 SAFETY PRECAUTIONS

- Indoor/outdoor wiring connections must be secured tightly and the cable should be routed properly so that there is no force pulling the cable from the connection terminals. Improper or loose connections can cause heat generation or fire.
- Safely dispose off the packing materials. Like screws, nails, batteries, broken things etc after installation or svc and then tear away and throw away the plastic packaging bags. Children may play with them and cause injury.
- Make sure to check that the power cable plug is not dirty, loose or broken and then only insert the plug completely. Dirty, loose or broken power plug can cause electric shock or fire.
- Be sure to check the refrigerant to be used. Please read the label on the product. Incorrect refrigerant used can prevent the normal operation of the unit.
- Don't use a power cord, a plug or a loose socket which is damaged. Otherwise it may cause a fire or electrical shock.
- Do not touch, operate, or repair the product with wet hands. Hold the plug by hand when taking out. There is risk of electric shock or fire.
- Do not place a heater or other heating appliances near the power cable. There is risk of fire and electric shock.
- Do not allow water to run into electric parts. Install the unit away from water sources. There is risk of fire, failure of the product, or electric shock.
- Do not store or use or even allow flammable gas or combustibles near the product. There is risk of fire.
- Do not use the product in a tightly closed space for a long time. Perform ventilation regularly. Oxygen deficiency could occur and hence harm your health.
- Do not open the front grille of the product during operation. (Do not touch the electrostatic filter, if the unit is so equipped.) There is risk of physical injury, electric shock, or product failure.
- If strange sounds, smell or smoke comes from product. Immediately turn the breaker off or disconnect the power supply cable. There is risk of electric shock or fire.
- Ventilate the product room from time to time when operating it together with a stove, or heating element etc. Oxygen deficiency can occur and hence harm your health.
- Turn the main power off and unplug the unit when cleaning or repairing the product. There is risk of electric shock.
- When the product is not to be used for a long time, disconnect the power supply plug or turn off the breaker. There is risk of product damage or failure, or unintended operation.
- Take care to ensure that nobody especially kids could step on or fall onto the outdoor unit. This could result in personal injury and product damage.
- Take care to ensure that power cable could not be pulled out or damaged during operation. There is risk of fire or electric shock.
- Do not place ANYTHING on the power cable. There is risk of fire or electric shock.
- Do not plug or unplug the power supply plug to turn the unit ON/OFF. There is risk of fire or electric shock.
- When flammable gas leaks, turn off the gas and open a window for ventilation before turn the product on. Do not use the telephone or turn switches on or off. There is risk of explosion or fire.
- For inner cleaning, contact an Authorized Service Center or a dealer. Do not use harsh detergent that causes corrosion or damage on the unit. Harsh detergent may also cause failure of product, fire, or electronic shock.

 **CAUTION**

- Two or more people must lift and transport the product. Avoid personal injury.
- Do not install the product where it will be exposed to sea wind (salt spray) directly. It may cause corrosion on the product.
- Install the drain hose to ensure that the condensed water is drained away properly. A bad connection may cause water leakage.
- Keep level even when installing the product. To avoid vibration or noise.
- Do not install the product where the noise or hot air from the outdoor unit could damage or disturb the neighborhoods. It may cause a problem for your neighbors and hence dispute.
- Always check for gas (refrigerant) leakage after installation or repair of product. Low refrigerant levels may cause failure of product.
- Do not use the product for special purposes, such as preserving foods, works of art, etc. It is a consumer air conditioner, not a precision refrigeration system. There is risk of damage or loss of property.
- Do not block the inlet or outlet of air flow. It may cause product failure.
- Use a soft cloth to clean. Do not use harsh detergents, solvents or splashing water etc. There is risk of fire, electric shock, or damage to the plastic parts of the product.
- Do not touch the metal parts of the product when removing the air filter. There is risk of personal injury.
- Do not step on or put anything on the product. (outdoor units) There is risk of personal injury and failure of product.
- Always insert the filter securely after cleaning. Clean the filter every two weeks or more often if necessary. A dirty filter reduces the efficiency.
- Do not insert hands or other objects through the air inlet or outlet while the product is operating. There are sharp and moving parts that could cause personal injury.
- Be cautious when unpacking and installing the product. Sharp edges could cause injury.
- If the refrigerant gas leaks during the repair, do not touch the leaking refrigerant gas. The refrigerant gas can cause frostbite (cold burn)
- Do not tilt the unit when removing or uninstalling it. The condensed water inside can spill.
- Do not mix air or gas other than the specified refrigerant used in the system. If air enters the refrigerant system, an excessively high pressure results, causing equipment damage or injury.
- If the refrigerant gas leaks during the installation, ventilate the area immediately. Otherwise it can be harmful for your health.
- Dismantling the unit, treatment of the refrigerant oil and eventual parts should be done in accordance with local and national standards. Replace the all batteries in the remote control with new ones of the same type. Do not mix old and new batteries or different types of batteries. There is risk of fire or product failure.
- Do not recharge or disassemble the batteries. Do not dispose off batteries in a fire. They may burn or explode.
- If the liquid from the batteries gets onto your skin or clothes, wash it well with clean water. Do not use the remote if the batteries have leaked. The chemicals in batteries could cause burns or other health hazards.
- Do not let the air conditioner run for a long time when the humidity is very high and a door or a window is left open. Moisture may condense and wet or damage furniture.
- Do not expose your skin or kids or plants to the cool or hot air draft. This could harm to your health.
- If you eat the liquid from the batteries, brush your teeth and see doctor. Do not use the remote if the batteries have leaked. The chemicals in batteries could cause burns or other health hazards.
- Do not drink the water drained from the product. It is not sanitary and could cause serious health issues.
- Use a firm stool or ladder when cleaning, maintaining or repairing the product at an height. Be careful and avoid personal injury.

TABLE OF CONTENTS

2 TIPS FOR SAVING ENERGY

3 IMPORTANT SAFETY INSTRUCTIONS

7 ELECTRICAL SAFETY

- 7 Temporary Use of an Adapter
- 7 Temporary Use of an Extension Cord
- 7 Symbols used in this Manual

8 BEFORE USE

- 8 Components
- 9 Using the remote control
- 10 - Inserting batteries
- 10 - Installing the remote control holder

11 BASIC FUNCTIONS

- 11 Cooling your room
- 11 Heating your room
- 11 Removing humidity
- 12 Airing your room
- 12 Adjusting the fan speed
- 12 Adjusting the air flow direction
- 12 Setting the timer
- 12 - Setting the current time
- 13 - Turning on the air conditioner automatically at a set time
- 13 - Turning off the air conditioner automatically at a set time
- 13 - Canceling the timer setting
- 13 - Setting sleep mode

14 ADVANCED FUNCTIONS

- 14 Changing room temperature quickly
- 14 Indoor air purification
- 14 - Auto Clean operation
- 15 Plasma Purification operation (Optional)
- 15 Auto operation (Optional)
- 16 Auto Changeover operation (Optional)
- 16 °C/°F Conversion
- 16 Energy saving cooling mode
- 16 Display screen brightness
- 17 Operating the air conditioner without the remote control
- 17 Restarting the air conditioner automatically

18 MAINTENANCE

- 19 Cleaning the Air filter
- 19 Cleaning the Triple filter(Optional)
- 19 Cleaning the 3M filter(Optional)

20 TROUBLESHOOTING

- 20 Self-diagnosis function
- 20 Before requesting service
- 21 Operation ranges
- 22 Details of LG serial No.

23 SPECIFICATION

ELECTRICAL SAFETY

WARNING

- This appliance must be properly grounded. To minimize the risk of electric shock, you must always plug into a grounded outlet.
- Do not cut or remove the grounding prong from the power plug.
- Attaching the adapter ground terminal to the wall receptacle cover screw does not ground the appliance unless the cover screw is metal and not insulated, and the wall receptacle is grounded through the house wiring.
- If you have any doubt whether the air conditioner is properly grounded, have the wall receptacle and circuit checked by a qualified electrician.

Temporary Use of an Adapter

We strongly discourage the use of an adapter due to potential safety hazards. For temporary connections, use only a genuine adapter, available from most local hardware stores. Ensure that the large slot in the adapter is aligned with the large slot in the receptacle for a proper polarity connection.

To disconnect the power cord from the adapter, use one hand on each to avoid damaging the ground terminal. Avoid frequently unplugging the power cord as this can lead to eventual ground terminal damage.

WARNING

- Never use the appliance with a broken adapter.

Temporary Use of an Extension Cord

We strongly discourage the use of an extension cord due to potential safety hazards.

WARNING

- This appliance should be installed in accordance with national wiring regulations. This guide acts as a guide to help to explain product features.

Symbols used in this Manual

 This symbol alerts you to the risk of electric shock.

 This symbol alerts you to hazards that may cause harm to the air conditioner.

 This symbol indicates special notes.

BEFORE USE

Components

Indoor unit

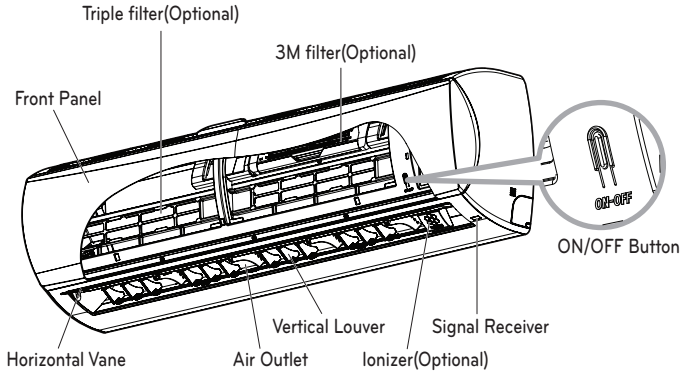

* The feature can be changed according to type of model.

! NOTE

The number of operation lamps and their locations may vary, depending on the model of the air conditioner.

Outdoor unit

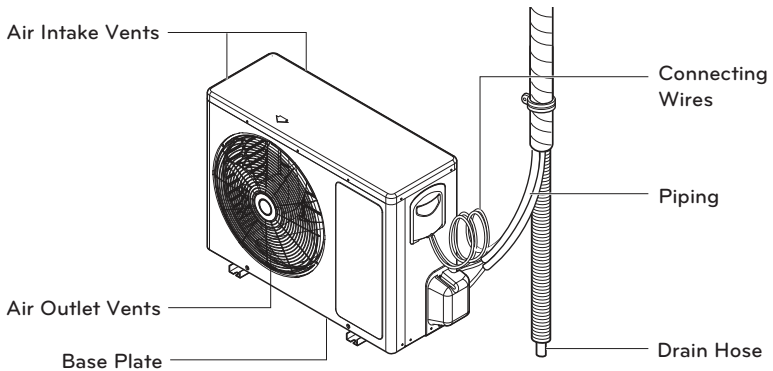

* The feature can be changed according to type of model.

Using the remote control

You can operate the air conditioner more conveniently with the remote control. You will find the buttons for the additional functions under the cover of the remote control.

Wireless remote control

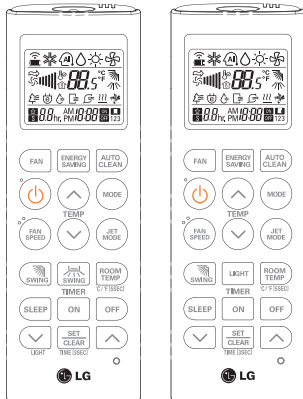
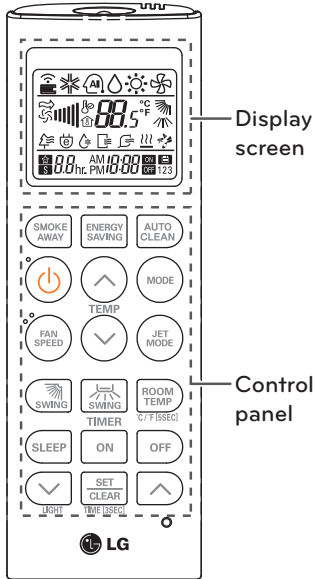

| Control panel | Display screen | Description |
|---------------|----------------|--|
| | - | On/Off button: Turns the power on/off. |
| | 88 °C | Temperature adjustment buttons: Adjusts the room temperature when cooling and heating. |
| | | Operation mode selection button*: Selects the operation mode. Cooling operation (❄️) / Auto operation or auto changeover (Ⓜ️) / Dehumidifying operation (💧) / Heating operation (🔥) / Air circulation (🌀) |
| | | Indoor fan speed button: Adjusts the fan speed. |
| | | Jet cooling/heating button*: Warms up or cools down the indoor temperature within a short period of time. |
| | | Functions button*: Sets the special functions. : Auto clean, : Operates energy saving cooling : Adjusts the brightness of the indoor unit display |
| | | Smoke Away button*: Purifies the air by removing particles that enter the indoor unit. |
| | | Air circulation button*: Used to circulate the room air without cooling or heating. |
| | | Air flow direction button: Adjusts the air flow direction vertically or horizontally. |
| | | Temperature display button: Displays the room temperature. |
| | | Sleep mode auto button*: Sets the sleep mode auto operation. |
| | | Timer button: Sets the current time and the start / end time. |
| | - | Set/clear button: Sets or cancels functions. |
| | - | Reset button: Initialize the air conditioner settings. |

* The icon can be changed according to type of model.

* Some functions may not be supported, depending on the model.

Inserting batteries

Insert batteries before using the remote control. The battery type used is AAA (1.5 V).

- 1 Remove the battery cover.

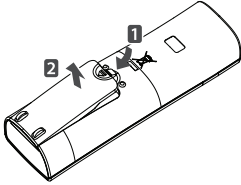

- 2 Insert the new batteries and make sure that the + and - terminals of the batteries are installed correctly.

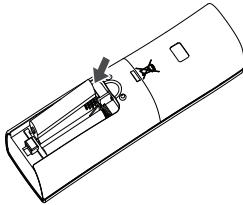

- 3 Reattach the battery cover.

! NOTE

If the display screen of the remote control starts to fade, replace the batteries.

Installing the remote control holder

Install the holder where there is no direct sunlight to protect the remote control.

- 1 Choose a safe and easily-accessible place.

- 2 Fix the holder by fastening the 2 screws firmly with a screwdriver.

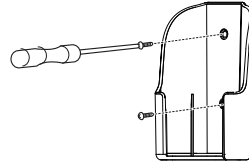

- 3 Slide the remote control into the holder.



Operating method

Point the remote control towards the signal receiver at the bottom of the air conditioner to operate it.

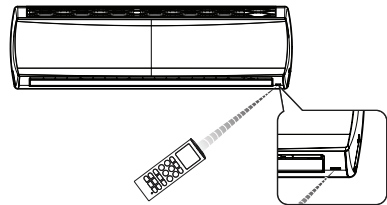



! NOTE

- The remote control may operate other electronic devices if pointed towards them. Make sure to point the remote control towards the signal receiver of the air conditioner.
- For proper operation, use a soft cloth to clean the signal transmitter and receiver.



BASIC FUNCTIONS

Cooling your room

(Cooling operation)

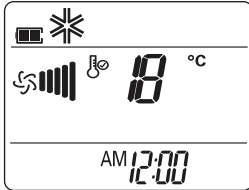

- 1 Press  to turn on the power.
- 2 Press  repeatedly to select the cooling operation.
-  is displayed on the display screen.





- 3 Press  or  to set the desired temperature.
- The temperature range is 18°C (64°F)-30°C (86°F).

Heating your room

(Heating operation)

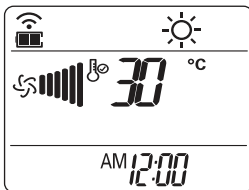
- 1 Press  to turn on the power.
- 2 Press  repeatedly to select the heating operation.
-  is displayed on the display screen.



- 3 Press  or  to set the desired temperature.
- The temperature range is 16°C (60°F)-30°C (86°F).



! NOTE

Cooling-only models do not support this function.

Removing humidity

(Dehumidifying operation)

This mode removes excess moisture from an environment with high humidity or in the rainy season, in order to prevent mold from setting in. This mode adjusts the room temperature and the fan speed automatically to maintain the optimal level of humidity.

- 1 Press  to turn on the power.
- 2 Press  repeatedly to select the dehumidifying operation.
-  is displayed on the display screen.

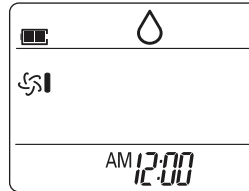

! NOTE

- In this mode you cannot adjust the room temperature, as it is adjusted automatically. Also, the room temperature is not displayed on the display screen.

Airing your room (Air Circulation operation)

This mode only circulates the indoor air without changing the room temperature. The cooling lamp lights up in air circulation mode.

- 1 Press to turn on the power.
- 2 Fan button : Press to turn on the air circulation operation.
Mode button : Press repeatedly to select air circulation operation.
- is displayed on the display screen.

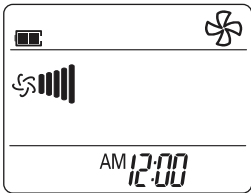

- 3 Press to adjust the fan speed.

Adjusting the fan speed

- 1 Press repeatedly to adjust the fan speed.
- Select if you want natural air.
The fan speed adjusts automatically.

| Remark | Speed |
|--------|--------------|
| | High |
| | Medium |
| | Low |
| | Natural Wind |

Adjusting the air flow direction

- 1 To adjust the direction of the air flow horizontally, press repeatedly and select the desired direction.
- Select to adjust the direction of the air flow automatically.
- 2 To adjust the direction of the air flow vertically, press repeatedly and select the desired direction.
- Select to adjust the direction of the air flow automatically.

NOTE

- Adjusting the air flow direction vertically may not be supported, depending on the model.
- Adjusting the air deflector arbitrarily may cause product failure.
- If you restart the air conditioner, it starts to operate with the previously set direction of air flow, so the air deflector may not match the icon displayed on the remote control. When this occurs, press or to adjust the direction of the air flow again.

Setting the timer

You can use the timer function to save energy and to use the air conditioner more efficiently.

Setting the current time

- 1 Press and hold it for longer than 3 seconds.
- The AM/PM icon flickers at the bottom of the display screen.

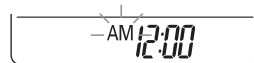

- 2 Press or to select the times.
- 3 Press to finish.

Turning on the air conditioner automatically at a set time

- Press **ON**.
 - The icon below flickers at the bottom of the display screen.

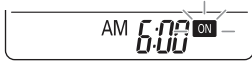

- Press **✓** or **△** to select the times.
- Press **SET/CLEAR** to finish.
- When setting the timer, current time and ON icon are displayed on the display screen indicating that the desired time is set.

Turning off the air conditioner automatically at a set time

- Press **OFF**.
 - The icon below flickers at the bottom of the display screen.

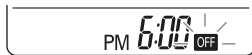

- Press **✓** or **△** to select the times.
- Press **SET/CLEAR** to finish.
- When setting the timer, current time and OFF icon are displayed on the display screen indicating that the desired time is set.

! CAUTION

- The air-condition will not operate if curtains, doors or other objects block the signals from the remote control to the indoor unit.
- Be careful that liquids do not spill onto the remote control.
- Do not expose the remote control to direct sunlight or heat.

If the infrared signal receiver on the indoor unit is exposed to direct sunlight, the air-condition may not function properly. Use curtains to prevent sunlight from receiving the receiver.
- Signals may not be properly received, if the room using the air-condition has fluorescent lighting with electronic starters. If you are planning on using fluorescent lamps, consult with local dealer.
- If other electrical appliances are activated by the remote control, move this appliance or consult with local dealer.

Canceling the timer setting

- Press **SET/CLEAR**.
 - To cancel all timer settings, press **SET/CLEAR**.

Setting sleep mode

Use the sleep mode to turn off the air conditioner automatically when you go to sleep.

- Press **⏻** to turn on the power.
- Press **SLEEP**.
- Press **✓** or **△** to select the hour (up to 7 hours).
- Press **SET/CLEAR** to finish.
 - ☆** is displayed on the display screen in sleep mode.

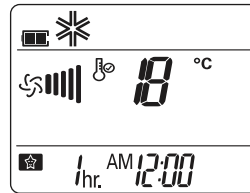

! NOTE



In the Cooling and Dehumidifying modes, the temperature increases by 1°C after 30 minutes and by a further 1°C after another 30 minutes for a more comfortable sleep. The temperature increases with up to 2°C from the preset temperature.

ADVANCED FUNCTIONS

The air conditioner offers some additional advanced functions.

Changing room temperature quickly (Jet Cool)

This mode allows you to cool indoor air quickly in summer or warm it quickly in winter.

- 1 Press  to turn on the power.
- 2 Press .

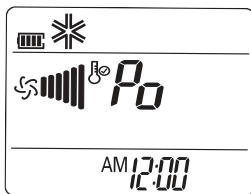

- In jet cooling mode, strong air blows out at a temperature of 18°C (64°F)- 30°C (86°F) minutes. for 30 minutes for fast and effective colling.



! NOTE

- Powerful Cooling
 - H/P Model (Powerful Heating Option is excluded)
Enable in Cooling/Dehumidifying/Heating Operation
 - C/O Model
Enable in Cooling/Dehumidifying/Fan/Artificial Intelligent/Air Clean Operation
- This function may not be supported, depending on the model.

Indoor air purification

Auto Clean operation

In the cooling and dehumidifying operations, moisture is generated inside the indoor unit. Use the auto cleaning function to remove such moisture.

- 1 Press  .
-  is displayed on the display screen.

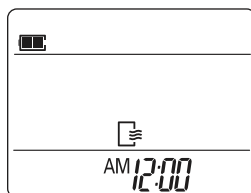
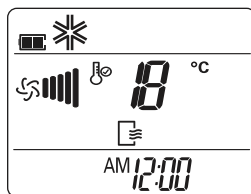



- If you turn off the power, the fan operates for 30 minutes and cleans the inside of the indoor unit.

! NOTE

Some buttons cannot be used while the auto cleaning function is in operation.

Smoke Away operation (Optional)

Smoke Away developed by LG removes microscopic contaminants from the intake air completely to supply clean and fresh air.

- 1 Press  to turn on the power.
- 2 Press .
 -  is displayed on the display screen.

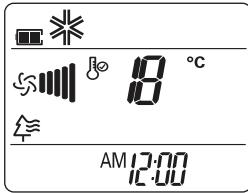





! NOTE

- You can use this function by pressing  without turning the air conditioner on.
- Both the plasma lamp and the cooling lamp light up while Smoke Away is in operation.
- This function may not be supported, depending on the model.

Auto operation (Optional) (Artificial intelligence)

Cooling-only models

In this mode, the fan speed and the temperature adjust automatically, based on the room temperature.

- 1 Press  to turn on the power.
- 2 Press  repeatedly to select auto operation.
- 3 Press  or  to select the desired operation code if the temperature is higher or lower than the desired temperature.

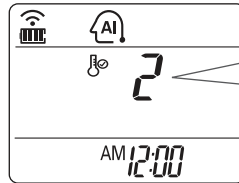



| Code | Description |
|------|---------------------------|
| 2 | Cool |
| 1 | Cool slightly |
| 0 | Maintain room temperature |
| -1 | Heat slightly |
| -2 | Heat |

! NOTE



- In this mode, you cannot adjust the fan speed, but you can set the air deflector to rotate automatically.
- This function may not be supported, depending on the model.

Auto Changeover operation (Optional)

This mode changes the operation mode automatically to maintain the set temperature at $\pm 2^{\circ}\text{C}$.

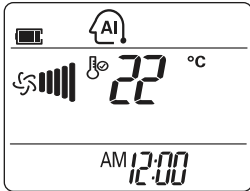
- 1 Press  to turn on the power.
- 2 Press  repeatedly to select the auto changeover operation.
 -  is displayed on the display screen.



- 3 Press  or  to set the desired temperature.
 - The temperature range is $18^{\circ}\text{C}(64^{\circ}\text{F}) - 30^{\circ}\text{C}(86^{\circ}\text{F})$.
- 4 Press  repeatedly to select the fan speed.

NOTE

This function may not be supported, depending on the model.

$^{\circ}\text{C}/^{\circ}\text{F}$ Conversion





The unit converts from $^{\circ}\text{C}$ to $^{\circ}\text{F}$ or from $^{\circ}\text{F}$ to $^{\circ}\text{C}$ if Room Temperature KEY is pressed for 5 seconds.

Energy saving cooling mode

This mode minimizes power consumption during cooling and increases the set temperature to the optimal level for a more comfortable environment.

The temperature automatically sets at $22^{\circ}\text{C}(72^{\circ}\text{F})$ if ambient temperature is below $22^{\circ}\text{C}(72^{\circ}\text{F})$.

The temperature maintains if ambient temperature is above $22^{\circ}\text{C}(72^{\circ}\text{F})$.

- 1 Press  to turn the power on.
- 2 Press  repeatedly to select the cooling operation.
- 3 Press .
 -  is displayed on the display screen.

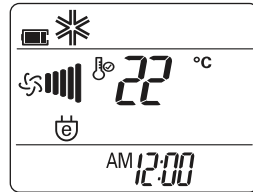

NOTE

This function may not be supported, depending on the model.

NOTE

Possible, Different temperature is displayed on between remote controller and air conditioner during operation.

Display screen brightness

You can adjust the brightness of the indoor unit display screen.

- 1 Press  or  turn on/off the Display screen.

NOTE

This function may not be supported, depending on the model.

Operating the air conditioner without the remote control

You can use the On/Off button of the indoor unit to operate the air conditioner when the remote control is unavailable. However, the fan speed is set to high.

- 1 Open the front cover.
 - Lift up both sides of the cover slightly.

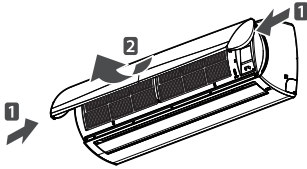

* The feature can be changed according to type of model.

- 2 Press the On/Off button.

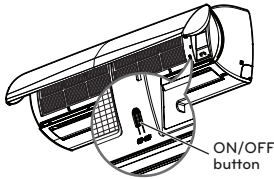

* The feature can be changed according to type of model.

- For cooling and heating models, the operation mode changes, depending on the room temperature.

| Room temp. | Set temp. | Operation mode |
|---|------------|-------------------------|
| Below 21°C(70°F) | 24°C(76°F) | Heating operation |
| Above 21°C(70°F) And Below 24°C(76°F) | 23°C(74°F) | Dehumidifying operation |
| Above 24°C(76°F) | 22°C(72°F) | Cooling operation |

- For cooling-only models, the temperature is set to 22°C (72°F).

Restarting the air conditioner automatically

When the air conditioner is turned on again after a power failure, this function restores the previous settings. This function is a factory default setting.

Disabling auto restart

- 1 Open the front cover.
 - Lift up both sides of the cover slightly.

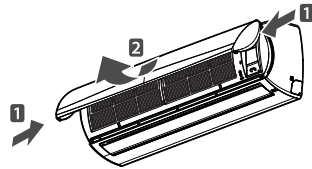

* The feature can be changed according to type of model.

- 2 Press the On/Off button and hold it for 6 seconds.
 - The unit will beep twice and the lamp will blink 6 times.

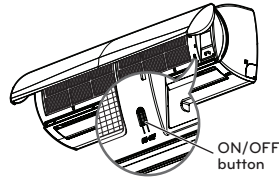

* The feature can be changed according to type of model.

- To re-enable the function, press the On/Off button and hold it for 6 seconds. The unit will beep twice and the blue lamp will blink 4 times.

NOTE

If you press and hold the On/Off button for 3 – 5 seconds instead of 6 seconds, the unit will switch to the test operation. In the test operation, the unit blows out strong air for cooling for 18 minutes and then returns to the factory default settings.

MAINTENANCE

Clean the product regularly to maintain optimal performance and to prevent possible breakdown.

* This may not be provided, depending on the model.

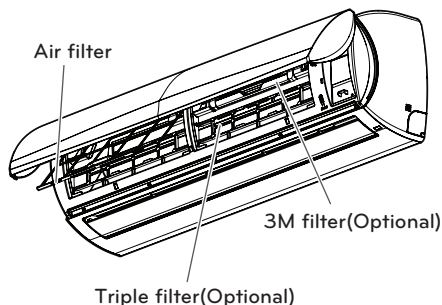

* The feature can be changed according to type of model.

| Item | Cleaning interval | Cleaning method |
|-------------------------|-------------------|--|
| Air filter | 2 weeks | See "Cleaning Air filter." |
| Triple Filter | 3 months | See "Cleaning Triple filter(Optional)." |
| Triple filter(Optional) | 1 months | |
| 3M filter(Optional) | 1 months | See "Cleaning 3M filter(Optional)." |
| Indoor unit surface | Regularly | Use a soft, dry cloth. Do not use bleach or abrasives. |
| Outdoor unit | Regularly | Use steam to clean the heat exchanger coils and the panel vents (consult with technician). |

⚠ CAUTION

- Turn off the power and unplug the power cord before you perform any maintenance; otherwise it may cause electric shock.
- Never use water that is hotter than 40°C(104°F) when you clean the filters. It may cause deformation or discoloration.
- Never use volatile substances when you clean the filters. They may damage the surface of the product.
- Do not washed the 3M filter with water, because the filter can be damaged.

! NOTE

- The location and shape of the filters may differ, depending on the model.
- Make sure to clean the heat exchanger coils of the outdoor unit regularly, as dirt collected in the coils may decrease the operational efficiency or increase energy costs.

Cleaning the Dual Protection Filter

Clean the dual protection filter once every 2 weeks or more if necessary.

- 1 Turn off the power and unplug the power cord.
- 2 Open the front cover.
 - Lift up both sides of the cover slightly.

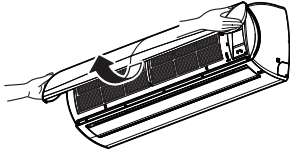

* The feature can be changed according to type of model.

- 3 Hold the knob of the dual protection filter, lift it up slightly and remove it from the unit.

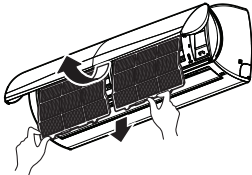

* The feature can be changed according to type of model.

- 4 Clean the filter with a vacuum cleaner or with warm water.
 - If dirt is difficult to remove, wash the filter in lukewarm water with detergent.
- 5 Dry the filter in the shade.

Cleaning the Triple filter (Optional)

- 1 Turn off the power and unplug the power cord.
- 2 Open the front cover and remove the air filter (see "Cleaning air filter").
- 3 Pull out the Triple filter(Optional)



* The feature can be changed according to type of model.

- 4 Use a vacuum cleaner to remove dirt, Do not wash the Triple filter with water, because the filter can be damaged.

! NOTE

- We suggest changing the Triple filter every 6 Months.
- The location of the filters may differ, depending on the model.
- If you need more filters, please contact the LG service center (Refer to the warranty card.)

Cleaning the 3M Filter (Optional)

- 1 Turn off the power and unplug the power cord.
- 2 Open the front cover and remove the air filter (see "Cleaning air filter").
- 3 Pull out the 3M Filter.



* The feature can be changed according to type of model.

- 4 Use a vacuum cleaner to remove dirt, Do not wash the 3M Filter with Water, because the filter can be damaged.

! NOTE

- We suggest changing the 3M Filter every 6 Months.
- The location of the filters may differ, depending on the model.
- If you need more filters, please contact the LG service center (Refer to the warranty card.)

TROUBLESHOOTING

Self-diagnosis function

This product has a built-in self-diagnosis function. If an error occurs, the lamp of the indoor unit will blink in 2 second intervals. If this occurs, contact your local dealer or service center.

Before requesting service

Please check the following before you contact the service center. If the problem persists, contact your local service center.

| Problem | Possible causes | Corrective action |
|--|--|---|
| There is a burning smell and a strange sound coming from the unit. | | Turn off the air conditioner, unplug the power cord and contact the service center. |
| Water leaks from the indoor unit even when the humidity level is low. | | |
| The power cord is damaged or generating excessive heat. | | |
| A switch, a circuit breaker (safety, ground) or a fuse is not operated properly. | | |
| The air conditioner does not work. | The air conditioner is unplugged. | Check whether the power cord is plugged into the outlet. |
| | A fuse is blown or the power supply is blocked. | Replace the fuse or check if the circuit breaker has tripped. |
| | A power failure has occurred. | Turn off the air conditioner when a power failure occurs. When the power is restored, wait 3 minutes, and then turn on the air conditioner. |
| | The voltage is too high or too low. | Check if the circuit breaker has tripped. |
| | The air conditioner turned off automatically at a preset time. | Press the power button again. |

| Problem | Possible causes | Corrective action |
|---|---|--|
| The air conditioner does not generate cool air. | Air is not circulating properly. | Make sure that there are no curtains, blinds or furniture blocking the front of the air conditioner. |
| | The air filter is dirty. | Clean the air filter once every 2 weeks. See "Cleaning Air Filter" for more information. |
| | The room temperature is too high. | In summer, it may take some time to cool indoor air. In this case, select the jet cool operation to cool indoor air quickly. |
| | Cold air is escaping from the room. | Make sure that no cold air is escaping through ventilation points in the room. |
| | The desired temperature is higher than the set temperature. | Set the desired temperature to a level lower than the current temperature. |
| | There is a heating source nearby. | Avoid using a heat generator such as an electric oven or a gas burner while the air conditioner is in operation. |
| | Air circulation operation is selected. | In the air circulation operation, air blows from the air conditioner without cooling or heating the indoor air. Switch the operation mode to the cooling operation. |
| It is not possible to adjust the fan speed. | The auto operation, jet operation or dehumidifying operation is selected. | In some operation modes, such as the jet or dehumidifying operation modes, you cannot adjust the fan speed. Select an operation mode in which you can adjust the fan speed. |
| It is not possible to adjust the temperature. | The air circulation operation or jet operation is selected. | In some operation modes, such as the air circulation or jet operation mode, you cannot adjust the temperature. Select an operation mode in which you can adjust the temperature. |

Operation ranges

For Heat & Cool model, heating operation range follows the below table.

| Heating operation range | Outdoor temperature |
|-------------------------|---------------------|
| | 0 ~ 24 °C |

* When the outdoor temperature drops below 0 °C, heating capacity may drop slightly depending on the operation condition.

Details of LG serial No.

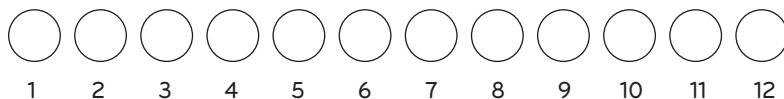

| Code | Detail | Code of Model | Meaning |
|------|---------------|-------------------|---|
| 1 | Year | 0~9 (Digit) | The last digit of year ex) 1997 → 7, 2000 → 0 |
| 2,3 | Month | 01~12 (Digit) | Month ex) March → 03, August → 08 |
| 4 | Nation | A~Z (Alphabet) | Where manufactured ex) K → Korea, S → Saudi Arabia |
| 5 | Product | A~Z (Alphabet) | ex) A → Airconditioner |
| 6,7 | Security Code | A~Z (Alphabet) | ex) TS, GH |
| 8~12 | Serial No. | 0~9 (Digit) | Production Quantity |

Main Service Part List

| NO | PART NAME |
|----|------------------|
| 1 | COMPRESSOR |
| 2 | MOTOR |
| 3 | CROSS FLOW FAN |
| 4 | MAIN PCB ASSY |
| 5 | DISPLAY PCB ASSY |
| 6 | REMOCON |
| 7 | FRONT GRILLE |
| 8 | TRANSFORMER |

H. G. IBRAHIM SHAKER COMPANY, LTD.

SERVICE CENTER

- * JEDDAH → P. O. BOX 50, JEDDAH 21411 KINGDOM OF SAUDI ARABIA
TEL NO. : (02)6738249
- * RIYADH → P. O. BOX 15, RIYADH 11411 KINGDOM OF SAUDI ARABIA
TEL NO. : (01)4020570
- * AL-KHOBAR → P. O. BOX 78, AL-KHOBAR 31952 KINGDOM OF SAUDI ARABIA
TEL NO. : (03)8141116
Toll Free No. 8002445454

SPECIFICATION

| | | | | |
|---------------------------------|-------------------|---------------------|---------------------|---------------------|
| Model | Indoor | S3228P NV2 | S3224C NV2 | S3024C NV2 |
| | Outdoor | S3228P UV2 | S3224C UV2 | S3024C UV2 |
| Brand | | LG Electronics Inc | LG Electronics Inc | LG Electronics Inc |
| Country of origin | | Korea | Korea | Korea |
| Type | | WALL MOUNTED | WALL MOUNTED | WALL MOUNTED |
| Voltage (V) | | 230 V ~ | 230 V ~ | 230 V ~ |
| Phase | | 1 Phase | 1 Phase | 1 Phase |
| Hz | | 60 Hz | 60 Hz | 60 Hz |
| Refrigerant | R22 (kg) | 1.4 | 1.4 | 1.4 |
| Cooling(T1) | Capacity (kW) | 8.21 | 8.21 | 8.15 |
| | Input (kW) | 2.93 | 2.93 | 2.92 |
| | Current (A) | 13 | 13 | 13 |
| | EER (Btu/Watt.hr) | 9.55 | 9.55 | 9.52 |
| Cooling(T3) | Capacity (kW) | 7.33 | 7.33 | 7.28 |
| | Input (kW) | 3.65 | 3.65 | 3.63 |
| | Current (A) | 16.5 | 16.5 | 16.5 |
| | EER (Btu/Watt.hr) | 6.85 | 6.85 | 6.84 |
| Dimensions | Indoor (W*H*D) | 1190*346*265 mm | 1190*346*265 mm | 1190*346*265 mm |
| | | 46.9*13.6*10.4 inch | 46.9*13.6*10.4 inch | 46.9*13.6*10.4 inch |
| | Outdoor (W*H*D) | 870*808*320 mm | 870*808*320 mm | 870*808*320 mm |
| | | 34.3*31.8*12.6 inch | 34.3*31.8*12.6 inch | 34.3*31.8*12.6 inch |
| Net Weight | Indoor | 18 kg | 18 kg | 18 kg |
| | Outdoor | 61.5 kg | 61.5 kg | 61.5 kg |
| Annual energy consumption (KWh) | | 7911 | 7911 | 7884 |

