



OWNER'S MANUAL

Safety and Reference

LED TV*

* LG LED TVs are LCD TVs with LED backlighting.

Please read this manual carefully before operating your set and retain it for future reference.

- | | | |
|----------|----------|----------|
| 40LF6300 | 42LF6500 | 32LF595B |
| 43LF6300 | 50LF6500 | 43LF5900 |
| 49LF6300 | 55LF6500 | 49LF5900 |
| 55LF6300 | 60LF6390 | 55LF5950 |
| 60LF6300 | 65LF6390 | |
| 65LF6300 | | |



www.lg.com

P/No : MFL68680203 (1504-REV04)

Important Safety Instructions

Always comply with the following precautions to avoid dangerous situations and ensure peak performance of your product.

Read these instructions.
Keep these instructions.
Heed all warnings.
Follow all instructions.



- Do not use this apparatus near water.



- Clean only with dry cloth.



- Do not block any ventilation openings. Install in accordance with the manufacturer's instructions.



- Do not install near any heat sources such as radiators, heat registers, stoves, or other apparatus (including amplifiers) that produce heat.



- Do not defeat the safety purpose of the polarized or grounding-type plug. A polarized plug has two blades with one wider than the other. A grounding type plug has two blades and a third grounding prong. The wide blade or the third prong are provided for your safety. If the provided plug does not fit into your outlet, consult an electrician for replacement of the obsolete outlet.



- Protect the power cord from being walked on or pinched particularly at plugs, convenience receptacles, and the point where they exit from the apparatus.



- Only use attachments/accessories specified by the manufacturer.



- Use only with the cart, stand, tripod, bracket, or table specified by the manufacturer, or sold with the apparatus. When a cart is used, use caution when moving the cart/apparatus combination to avoid injury from tip-over.



TO REDUCE THE RISK OF ELECTRIC SHOCK DO NOT REMOVE COVER (OR BACK). NO USER SERVICEABLE PARTS INSIDE. REFER TO QUALIFIED SERVICE PERSONNEL.

⚡ The lightning flash with arrowhead symbol within an equilateral triangle is intended to alert the user to the presence of uninsulated dangerous voltage within the product's enclosure that may be of sufficient magnitude to constitute a risk of electric shock to persons.

⚠ The exclamation point within an equilateral triangle is intended to alert the user to the presence of important operating and maintenance (servicing) instructions in the literature accompanying the appliance.

WARNING/CAUTION

- TO REDUCE THE RISK OF FIRE AND ELECTRIC SHOCK, DO NOT EXPOSE THIS PRODUCT TO RAIN OR MOISTURE.

⚠ WARNING

If you ignore the warning message, you may be seriously injured or there is a possibility of accident or death.

⚠ CAUTION

If you ignore the caution message, you may be slightly injured or the product may be damaged.

ⓘ NOTE

The note helps you understand and use the product safely. Please read the note carefully before using the product.

- Unplug this apparatus during lightning storms or when unused for long periods of time.



- Refer all servicing to qualified service personnel. Servicing is required when the apparatus has been damaged in any way, such as power-supply cord or plug is damaged, liquid has been spilled or objects have fallen into the apparatus, the apparatus has been exposed to rain or moisture, does not operate normally, or has been dropped.



- Do not press strongly upon the panel with a hand or a sharp object such as a nail, pencil, or pen, or make a scratch on it.



- Do not stick metal objects or any other conductive material into the power cord. Do not touch the end of the power cord while it is plugged in.
- Keep the packing anti-moisture material or vinyl packing out of the reach of children. Anti-moisture material is harmful if swallowed. If swallowed, induce vomiting and go to the nearest hospital. Additionally, vinyl packing can cause suffocation. Keep it out of the reach of children.
- CAUTION concerning the Power Cord (Can differ by country):
Check the specification page of this owner's manual to be certain. Do not connect too many appliances to the same AC power outlet as this could result in fire or electric shock. Do not overload wall outlets. Overloaded wall outlets, loose or damaged wall outlets, extension cords, frayed power cords, or damaged or cracked wire insulation are dangerous. Any of these conditions could result in electric shock or fire. Periodically examine the cord of your appliance, and if its appearance indicates damage or deterioration, unplug it, discontinue use of the appliance, and have the cord replaced with an exact replacement part by an authorized service. Protect the power cord from physical or mechanical abuse, such as being twisted, kinked, pinched, closed in a door, or walked upon. Pay particular attention to plugs, wall outlets, and the point where the cord exits the appliance. Do not move the TV with the power cord plugged in. Do not use a damaged or loose power cord. Be sure do grasp the plug when unplugging the power cord. Do not pull on the power cord to unplug the TV.



- **Warning** - To reduce the risk of fire or electrical shock, do not expose this product to rain, moisture or other liquids. Do not touch the TV with wet hands. Do not install this product near flammable objects such as

gasoline or candles, or expose the TV to direct air conditioning.



- Do not expose to dripping or splashing and do not place objects filled with liquids, such as vases, cups, etc. on or over the apparatus (e.g., on shelves above the unit).



• Grounding

(Except for devices which are not grounded.)

Ensure that you connect the earth ground wire to prevent possible electric shock (i.e., a TV with a three-prong grounded AC plug must be connected to a three-prong grounded AC outlet). If grounding methods are not possible, have a qualified electrician install a separate circuit breaker. Do not try to ground the unit by connecting it to telephone wires, lightning rods, or gas pipes.

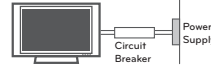

- As long as this unit is connected to the AC wall outlet, it is not disconnected from the AC power source even if the unit is turned off.
- Do not attempt to modify this product in any way without written authorization from LG Electronics. Unauthorized modification could void the user's authority to operate this product.

• Outdoor Antenna Grounding

(Can differ by country):

If an outdoor antenna is installed, follow the precautions below. An outdoor antenna system should not be located in the vicinity of overhead power lines or other electric light or power circuits, or where it can come in contact with such power lines or circuits as death or serious injury can occur. Be sure the antenna system is grounded to provide some protection against voltage surges and built-up static charges. Section 810 of the National Electrical Code (NEC) in the U.S.A. provides information with respect to proper grounding of the mast and supporting structure, grounding of the lead-in wire to an antenna discharge unit, size of grounding conductors, location of antenna discharge unit, connection to grounding electrodes, and requirements for the grounding electrode.

Antenna grounding according to the National Electrical Code, ANSI/NFPA 70

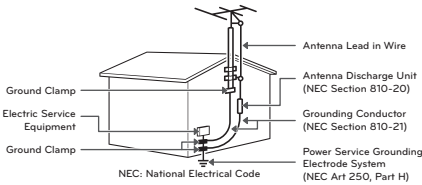

• Cleaning

When cleaning, unplug the power cord and wipe gently with a soft cloth to prevent scratching. Do not spray water or other liquids directly on the TV as electric shock may occur. Do not clean with chemicals such as alcohol, thinners, or benzene.

• Moving

Make sure the product is turned off, unplugged, and all cables have been removed. It may take 2 or more people to carry larger TVs. Do not press or put stress on the front panel of the TV.

• Ventilation

Install your TV where there is proper ventilation. Do not install in a confined space such as a bookcase. Do not cover the product with cloth or other materials while plugged in. Do not install in excessively dusty places.

- If you smell smoke or other odors coming from the TV, unplug the power cord and contact an authorized service center.
- Keep the product away from direct sunlight.
- Never touch this apparatus or antenna during a lightning storm.
- When mounting a TV on the wall, make sure not to install the TV by hanging the power and signal cables on the back of the TV.
- Do not allow an impact shock or any objects to fall into the product, and do not drop anything onto the screen.

• DISCONNECTING THE DEVICE FROM THE MAIN POWER

The power plug is the disconnecting device. In case of an emergency, the power plug must remain readily accessible.

• Batteries

Store the accessories (battery, etc.) in a safe location out of the reach of children.

- This apparatus uses batteries. In your community there might be regulations that require you to dispose of these batteries properly due to environmental considerations. Please contact your local authorities for disposal or recycling information.
- Do not dispose of batteries in a fire.
- Do not short circuit, disassemble, or allow the batteries to overheat.
- Do not use high voltage electrical equipment near the TV, (e.g., a bug zapper). This may result in product malfunction.

• Dot Defect

The panel is a high technology product with resolution of two million to six million pixels. In a very few cases, you could see fine dots on the screen while you're viewing the TV. Those dots are deactivated pixels and do not affect the performance and reliability of the TV.

• Generated Sound

Cracking noise A cracking noise that occurs when watching or turning off the TV is generated by plastic thermal contraction due to temperature and humidity. This noise is common for products where thermal deformation is required.

Electrical circuit humming/panel buzzing

A low level noise is generated from a high-speed switching circuit, which supplies a large amount of current to operate a product. It varies depending upon the product. This generated sound does not affect the performance and reliability of the product.

- Take care not to touch the ventilation openings. When watching the TV for a long period, the ventilation openings may become hot. This does not affect the performance of the product or cause defects in the product.
- Do not install this product on a wall if it could be exposed to oil or oil mist. This may damage the product and cause it to fall.
- If the TV feels cold to the touch, there may be a small flicker when it is turned on. This is normal; there is nothing wrong with TV. Some minute dot defects may be visible on the screen, appearing as tiny red, green, or blue spots. However, they have no adverse effect on the TV's performance. Avoid touching the LCD screen or holding your finger(s) against it for long periods of time. Doing so may produce some temporary distortion effects on the screen.

Preventing image burn or burn-in on your TV screen

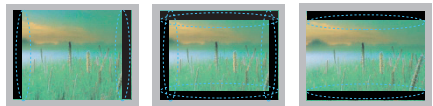

- If a fixed image displays on the TV screen for a long period of time, it will be imprinted and become a permanent disfigurement on the screen. This is image burn or burn-in and not covered by the warranty.

- If the aspect ratio of the TV is set to 4:3 for a long period of time, image burn may occur on the letterboxed area of the screen.
- Avoid displaying a fixed image on the TV screen for a long period of time (2 or more hours for LCD, 1 or more hours for the Plasma TV) to prevent image burn.

FCC Notice

(For USA)

This equipment has been tested and found to comply with the limits for a Class B digital device, pursuant to Part 15 of the FCC Rules. These limits are designed to provide reasonable protection against harmful interference in a residential installation.

This equipment generates, uses, and can radiate radio frequency energy and, if not installed and used in accordance with the instructions, may cause harmful interference to radio communications.

However, there is no guarantee that interference will not occur in a particular installation. If this equipment does cause harmful interference to radio or television reception, which can be determined by turning the equipment off and on, the user is encouraged to try to correct the interference by one or more of the following measures:

- Reorient or relocate the receiving antenna.
- Increase the separation between the equipment and the receiver.
- Connect the equipment to an outlet on a circuit different from that to which the receiver is connected.
- Consult the dealer or an experienced radio/TV technician for help.

This device complies with part 15 of the FCC Rules. Operation is subject to the following two conditions:

(1) this device may not cause harmful interference and (2) this device must accept any interference received, including interference that may cause undesired operation of the device.

Any changes or modifications in construction of this device which are not expressly approved by the party responsible for compliance could void the user's authority to operate the equipment.

FCC Radio Frequency Interference Requirements (for UNII devices)

High power radars are allocated as primary users of the 5.25 to 5.35 GHz and 5.65 to 5.85 GHz bands. These radar stations can cause interference with and/or damage this device. This device cannot be co-located with any other transmitter.

FCC RF Radiation Exposure Statement

[For having wireless function (WLAN, Bluetooth,...)]

This equipment complies with FCC radiation exposure limits set forth for an uncontrolled environment. This transmitter must not be co-located or operating in conjunction with any other antenna or transmitter.

This equipment should be installed and operated with minimum distance 20 cm (7.8 inches) between the antenna and your body. Users must follow the specific operating instructions for satisfying RF exposure compliance.

Industry Canada Statement

(For Canada)

[For having wireless function (WLAN, Bluetooth,...)]

This device complies with RSS-210 of the Industry Canada Rules. Operation is subject to the following two conditions:

1. this device may not cause interference and
2. this device must accept any interference, including interference that may cause undesired operation of the device.

IC Radiation Exposure Statement

(For Canada)

[For having wireless function (WLAN, Bluetooth,...)]

This equipment complies with IC radiation exposure limits set forth for an uncontrolled environment.

This equipment should be installed and operated with minimum distance 20 cm (7.8 inches) between the antenna and your body.

NOTE: THE MANUFACTURER IS NOT RESPONSIBLE FOR ANY RADIO OR TV INTERFERENCE CAUSED BY UNAUTHORIZED MODIFICATIONS TO THIS EQUIPMENT. SUCH MODIFICATIONS COULD VOID THE USER'S AUTHORITY TO OPERATE THE EQUIPMENT.

WARNING

(For Canada)

[For product having the wireless function using 5 GHz frequency bands]

- The device for operation in the band 5150–5250 MHz is only for indoor use to reduce the potential for harmful interference to co-channel mobile satellite systems;
- The maximum antenna gain permitted for devices in the bands 5250–5350 MHz and 5470–5725 MHz shall comply with the EIRP limit; and
- The maximum antenna gain permitted for devices in the band 5725–5825 MHz shall comply with the EIRP limits specified for point-to-point and non point-to-point operation as appropriate.
- High-power radars are allocated as primary users (i.e., priority users) of the bands 5250–5350 MHz and 5650–5850 MHz and that these radars could cause interference and/or damage to LE-LAN devices.

Note to Cable/TV Installer

(For USA and Canada)

This reminder is provided to call the CATV system installer's attention to Article 820-40 of the National Electric Code (U.S.A.). The code provides guidelines for proper grounding and, in particular, specifies that the cable ground shall be connected to the grounding system of the building, as close to the point of the cable entry as practical.

Viewing 3D Imaging (For 3D models)

WARNING

Viewing Environment

- Viewing Time
 - When watching 3D contents, take five- to fifteen-minute breaks every hour. Viewing 3D contents for a long period of time may cause headache, dizziness, fatigue or eye strain.

Those that have a photosensitive seizure or chronic illness

- Some users may experience a seizure or other abnormal symptoms when they are exposed to a flashing light or particular pattern from 3D contents.
- Do not watch 3D videos if you feel nausea, are pregnant and/ or have a chronic illness such as epilepsy, cardiac disorder, or blood pressure disease, etc.
- 3D Contents are not recommended to those who suffer from stereo blindness or stereo anomaly. Double images or discomfort in viewing may be experienced.

- If you have strabismus (cross-eyed), amblyopia (weak eyesight) or astigmatism, you may have trouble sensing depth and easily feel fatigue due to double images. It is advised to take frequent breaks than the average adult.
- If your eyesight varies between your right and left eye, correct your eyesight prior to watching 3D contents.

Symptoms which require discontinuation or refraining from watching 3D contents

- Do not watch 3D contents when you feel fatigue from lack of sleep, overwork or drinking.
- When these symptoms are experienced, stop using/watching 3D contents and get enough rest until the symptom subsides.
 - Consult your doctor when the symptoms persist. Symptoms may include headache, eyeball pain, dizziness, nausea, palpitation, blurriness, discomfort, double image, visual inconvenience or fatigue.

CAUTION

Viewing Environment

- Viewing Distance
 - Maintain a distance of at least twice the screen diagonal length when watching 3D contents. If you feel discomfort in viewing 3D contents, move further away from the TV.

Viewing Age

- Infants / Children
 - Usage/Viewing 3D contents for children under the age of 5 are prohibited.
 - Children under the age of 10 may overreact and become overly excited because their vision is in development (for example: trying to touch the screen or trying to jump into it.) Special monitoring and extra attention is required for children watching 3D contents.
 - Children have greater binocular disparity of 3D presentations than adults because the distance between the eyes is shorter than one of adults. Therefore they will perceive more stereoscopic depth compared to adults for the same 3D image.
- Teenagers
 - Teenagers under the age of 19 may be stimulated by light coming from 3D videos. Advise them not to watch 3D videos for a long time when they are tired.
- Elderly
 - The elderly may perceive less of a 3D effect than the youth. Do not sit closer to the TV than the recommended distance.

Cautions when using the 3D glasses

- Make sure to use LG 3D glasses. Otherwise, you may not be able to view 3D videos properly.
- Do not use 3D glasses instead of your normal glasses, sunglasses or protective goggles.
- Using modified 3D glasses may cause eye strain or image distortion.
- Do not keep your 3D glasses in extremely high or low temperatures. It will cause deformation.
- The 3D glasses are fragile and are easily scratched. Always use a soft, clean piece of cloth when wiping the lenses. Do not scratch the lenses of the 3D glasses with sharp objects or clean/wipe them with chemicals.

⚠ CAUTION

- Do not use any unapproved items to ensure the safety and product's lifespan.
- Any damages or injuries by using unapproved items are not covered by the warranty.
- In case of some model, the thin film on screen is a part of the TV, So don't take it off.
- When attaching the stand to the TV set, place the screen facing down on a cushioned table or flat surface to protect the screen from scratches.
- Make sure that the screws are fastened tightly. (If they are not fastened securely enough, the TV may tilt forward after being installed.)
- Do not tighten the screws with too much force; otherwise they may be damaged and come loose later.

Preparing

! NOTE

- Image shown may differ from your TV.
- Your TV's OSD (On Screen Display) may differ slightly from that shown in this manual.
- The available menus and options may differ from the input source or product model that you are using.
- New features may be added to this TV in the future.
- The items supplied with your product may vary depending upon the model.
- Product specifications or contents of this manual may be changed without prior notice due to upgrade of product functions.
- For an optimal connection, HDMI cables and USB devices should have bezels less than 10 mm (0.39 inches) thick and 18 mm (0.7 inches) width.
- Use an extension cable that supports USB 2.0 if the USB cable or USB flash drive does not fit into your TV's USB port.
- Use a certified cable with the HDMI logo attached. If you do not use a certified HDMI cable, the screen may not display or a connection error may occur.
- Recommended HDMI cable types (3 m or less)
 - High-Speed HDMI®/™ cable
 - High-Speed HDMI®/™ cable with Ethernet

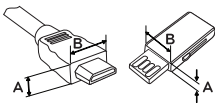

*A ≤ 10 mm (0.39 inches)

*B ≤ 18 mm (0.7 inches)

Optional Extras

Optional extras can be changed or modified for quality improvement without any notification. Contact your dealer for buying these items. These devices only work with certain models. The model name or design may be changed manufacturer's circumstances or policies. (Depending upon model)

AN-MR6** Magic Remote	AG-F*** Cinema 3D Glasses	AN-VC550 Smart Camera
AG-F***DP Dual Play Glasses	LG Audio Device	AN-WF500 Wi-Fi/ Bluetooth DONGLE

Maintenance

Cleaning Your TV

Clean your TV regularly to keep it at peak performance and to extend the product lifespan.

⚠ CAUTION

- Make sure to turn the power off and disconnect the power cord and all other cables first.
- When the TV is left unattended or unused for a long time, disconnect the power cord from the wall outlet to prevent possible damage from lightning or power surges.

Screen, Frame, Cabinet, and Stand

To remove dust or light dirt, wipe the surface with a dry, clean, and soft cloth.

To remove major dirt, wipe the surface with a soft cloth dampened in clean water or a diluted mild detergent. Then wipe immediately with a dry cloth.

⚠ CAUTION

- Do not push, rub, or hit the surface with your fingernail or a sharp object, as this may result in scratches on the screen and image distortions.
- Do not use any chemicals, such as waxes, benzene, alcohol, thinners, insecticides, air fresheners, lubricants, as these may damage the screen's finish and cause discoloration.
- Do not spray liquid onto the surface. If water enters the TV, it may result in fire, electric shock, or malfunction.

Power Cord

Remove the accumulated dust or dirt on the power cord regularly.

Lifting and Moving the TV

When moving or lifting the TV, read the following to prevent the TV from being scratched or damaged and for safe transportation regardless of its type and size.

- Move the TV in the box or packing material that the TV originally came in.
- Before moving or lifting the TV, disconnect the power cord and all cables.

- When holding the TV, the screen should face away from you to avoid damage.



- Hold the top and bottom of the TV frame firmly. Make sure not to hold the transparent part, speaker, or speaker grille area.

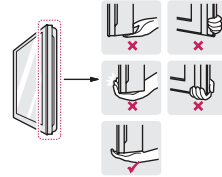

- Use at least two people to move a large TV.
- When transporting the TV by hand, hold the TV as shown in the following illustration.
- When transporting the TV, do not expose the TV to jolts or excessive vibration.
- When transporting the TV, keep the TV upright; never turn the TV on its side or tilt towards the left or right.
- When handling the TV, be careful not to damage the protruding joystick button.

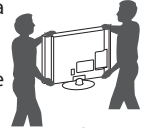

⚠ CAUTION

- Avoid touching the screen at all times, as this may result in damage to the screen.
- Do not place the product on the floor with its front facing down without padding. Failure to do so may result in damage to the screen.
- Do not move the TV by holding the cable holder or cable management, as the cable holders may break, and injuries and damage to the TV may occur. (Depending upon model)



Using the Joystick Button

(Image shown may differ from your TV.)

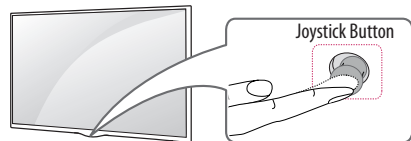
You can operate the TV by pressing the button or moving the joystick left, right, up, or down.

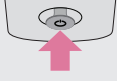
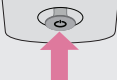

Basic functions





 <p>Power On</p>	<p>When the TV is turned off, place your finger on the joystick button, press it once, and release it.</p>
 <p>Power Off</p>	<p>When the TV is turned on, place your finger on the joystick button, press it once for a few seconds, and release it. All running apps will close.</p>
 <p>Volume Control</p>	<p>Place your finger on the joystick button and move it left or right to adjust the volume level.</p>
 <p>Channels Control</p>	<p>Place your finger on the joystick button and move it up or down to adjust the channel.</p>

NOTE

- Move the joystick button up, down, left, or right. Be careful not to press it. If you press it first, you may not be able to adjust the volume or scroll through the channels.

Adjusting the Menu

When the TV is turned on, press the joystick button one time. You can adjust the menu items moving the joystick button up, down, left, or right.

	<p>Turns the power off.</p>
	<p>Accesses the quick settings. (Depending upon model)</p>
	<p>Clears on-screen displays and returns to TV viewing.</p>
	<p>Changes the input source.</p>

Mounting on a Table

(Image shown may differ from your TV.)

- 1 Lift and tilt the TV into its upright position on a table.
 - Leave a 10 cm (4 inches) (minimum) space from the wall for proper ventilation.

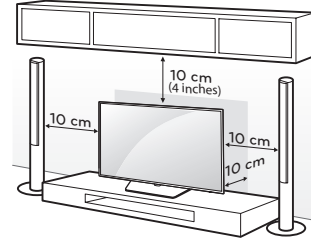

- 2 Connect the power cord to a wall outlet.

CAUTION

- Do not place the TV near or on sources of heat, as this may result in fire or other damage.

Using the Kensington Security System (optional)

(Depending upon model)

(Image shown may differ from your TV.)

The Kensington security system connector is located at the rear of the TV. For more information of installation and using, refer to the manual provided with the Kensington security system or visit <http://www.kensington.com>. Connect the Kensington security system cable between the TV and a table.

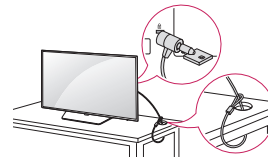

NOTE

- The Kensington security system is optional. You can obtain additional accessories from your local dealer.

Securing the TV to a Wall (optional)

(Depending upon model)

(Image shown may differ from your TV.)

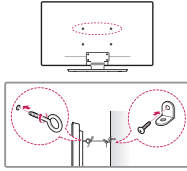

- 1 Insert and tighten the eye-bolts, or TV brackets and bolts on the back of the TV.
- If there are bolts inserted at the eye-bolts position, remove the bolts first.
- 2 Mount the wall brackets with the bolts to the wall. Match the location of the wall bracket and the eye-bolts on the rear of the TV.
- 3 Connect the eye-bolts and wall brackets tightly with a sturdy rope or cable. Make sure to keep the rope parallel to the flat surface.

⚠ CAUTION

- Make sure that children do not climb on or hang on the TV.

! NOTE

- Use a platform or cabinet that is strong and large enough to support the TV securely.
- Brackets, bolts, and ropes are optional. You can obtain additional accessories from your local dealer.

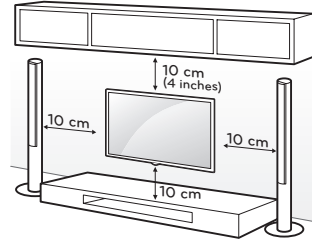

Make sure to use screws and wall mounts that meet the VESA standard. Standard dimensions for the wall mount kits are described in the following table.

Model	40/43LF6300 32LF595B 43LF5900	42/50/55LF6500 55LF5950
VESA (A x B)	200 x 200	400 x 400
Standard screw	M6	M6
Number of screws	4	4
Wall mount bracket (optional)	LSW240B MSW240	LSW440B MSW240
Model	49/55LF6300 49LF5900	60/65LF6300 60/65LF6390
VESA (A x B)	300 x 300	300 x 300
Standard screw	M6	M6
Number of screws	4	4
Wall mount bracket (optional)	LSW350B MSW240	LSW350B

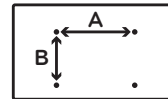

⚠ CAUTION

- Disconnect the power before moving or installing the TV. Otherwise electric shock may occur.
- Remove the stand before installing the TV on a wall mount by performing the stand attachment in reverse.
- If you install the TV on a ceiling or slanted wall, it may fall and result in severe injury. Use an authorized LG wall mount and contact the local dealer or qualified personnel. When using a third-party wall mount, it is not covered by the warranty.
- Do not overtighten the screws as this may cause damage to the TV and void your warranty.
- Use the screws and wall mounts that meet the VESA standard. Any damages or injuries by misuse or using an improper accessory are not covered by the warranty.

Mounting on a Wall

An optional wall mount can be used with your LG television. Consult with your local dealer for a wall mount that supports the VESA standard used by your TV model. Carefully attach the wall mount bracket at the rear of the TV. Install the wall mount bracket on a solid wall perpendicular to the floor. If you are attaching the TV to other building materials, please contact qualified personnel to install the wall mount. Detailed instructions will be included with the wall mount. We recommend that you use an LG brand wall mount. The LG wall mount is easy to adjust or to connect the cables. When you do not use LG's wall mount bracket, use a wall mount bracket where the device is adequately secured to the wall with enough space to allow connectivity to external devices. If you are using a non-adjustable mount, attach the mount to the wall. Attach the cables to the TV first, then attach the TV to the mount.

! NOTE

- Use the screws that are listed on the VESA standard screw specifications.
- The wall mount kit includes an installation manual and necessary parts.
- The wall mount bracket is optional. You can obtain additional accessories from your local dealer.
- The length of screws may differ depending upon the wall mount. Make sure to use the proper length.
- For more information, refer to the manual supplied with the wall mount.
- When using the wall mounting bracket, apply the adhesive protective label to cover the unused stand opening(s). This will prevent the accumulation of dust and dirt. (Use only when provided with your particular model.)

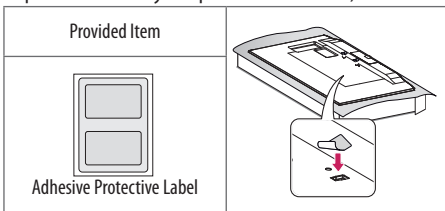

- When attaching a wall mounting bracket to the TV, insert the wall mount inner spacers into the TV wall mount holes to adjust the vertical angle of the TV. (Use only when provided with your particular model.)

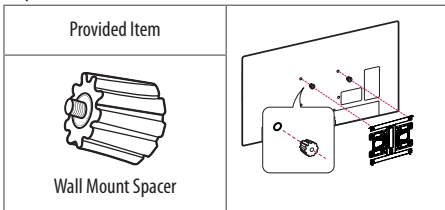

Connections (Notifications)

You can connect various external devices to the TV. Supported external devices are: HD receivers, DVD players, VCRs, audio systems, USB storage devices, PC, gaming devices, and other external devices. For more information on external device's connection, refer to the manual provided with each device.

! NOTE

- If you record a TV program on a DVD recorder or VCR, make sure to connect the TV signal input cable to the TV through a DVD recorder or VCR. For more information of recording, refer to the manual provided with the connected device.
- The external device connections may differ from the model.
- Connect external devices to the TV regardless of the order of the TV port.
- If you connect a gaming device to the TV, use the cable supplied with the gaming device.
- Refer to the external equipment's manual for operating instructions.
- In PC mode, there may be noise associated with the resolution, vertical pattern, contrast or brightness. If noise is present, change the PC output to another resolution, change the refresh rate to another rate or adjust the brightness and contrast on the PICTURE menu until the picture is clear.
- Depending upon the graphics card, some resolution settings may not allow the image to be positioned on the screen properly.

Connecting to an Antenna or Cable

Connect an antenna, cable, or cable box to watch TV. The RF cable may not be supplied, depending upon the model.

! CAUTION

- Make sure not to bend the copper wire of the RF cable.



- Complete all connections between devices, and then connect the power cord to the power outlet to prevent damage to your TV.

! NOTE

- Use a signal splitter to use 2 TVs or more.
- DTV Audio Supported Codec: MPEG, Dolby Digital.

Other Connections

Connect your TV to external devices. For the best picture and audio quality, connect the external device and the TV with the HDMI cable. Depending upon the model, a cable may not be provided.

Remote Control

(Depending upon model)

The descriptions in this manual are based on the buttons on the remote control. Please read this manual carefully and use the TV correctly. To install batteries, open the battery cover, replace batteries (1.5 V AAA) matching the ⊕ and ⊖ ends to the label inside the compartment, and close the battery cover. Failure to match the correct polarities of the battery may cause the battery to burst or leak, resulting in fire, personal injury, or ambient pollution. To remove the batteries, perform the installation actions in reverse. This remote uses infrared light. When in use, it should be pointed in the direction of the TV's remote sensor.

⚠ CAUTION

- Do not mix old and new batteries, as this may damage the remote control.

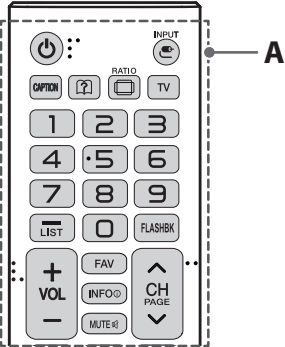

- ⏻ (POWER)** Turns the TV on or off.
- 📺 INPUT** Changes the input source.
- CAPTION** Activates or deactivates the subtitles.
- 🔍 (User Guide)** Sees user-guide.
- 📐 RATIO** Resizes an image.
- TV** Returns to the last TV channel.
- Number button** Enters numbers.
- (Dash)** Inserts a dash between numbers such as 2-1 and 2-2.
- LIST** Accesses the saved channel list.
- FLASHBK** Alternates between the two last channels selected (pressing repeatedly).

- + VOL -** Adjusts the volume level.
- FAV** Accesses your favorite channel list.
- INFO** Shows information on the current program.
- MUTE** Mutes all sounds.
- ^ CH v** Scrolls through the saved channels.
- ^ PAGE v** Moves to the previous or next screen.

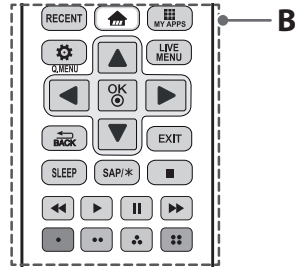

- RECENT** Shows the previous history.
- 🏠 (Home)** Accesses the Home menu.
- 📺 MY APPS** Shows the list of Apps.
- ⚙️ Q.MENU** Accesses the quick settings.
- LIVE MENU** Shows the list of Channels.
- Navigation buttons** Scrolls through menus or options. (up/down/left/right)
- OK** Selects menus or options and confirms your input.
- ↶ BACK** Returns to the previous screen.
- EXIT** Clears all on-screen displays and returns to TV viewing.
- SLEEP** Sets the length of time until the TV to turn off.
- SAP/*** Enables SAP (Secondary Audio Program) Feature.
- Control buttons** (⏪, ▶, ⏸, ⏩) Controls the SIMPLINK compatible devices (USB, SIMPLINK).
- Color buttons** These access special functions in some menus. (🟢, 🟡, 🔴, 🟠)

Magic Remote Functions

(Depending upon model)

When the message *Magic remote control battery is low. Change the battery.* is displayed, replace the battery. To install batteries, open the battery cover, replace batteries (1.5 V AA) matching ⊕ and ⊖ ends to the label inside the compartment, and close the battery cover. Failure to match the correct polarities of the battery may cause the battery to burst or leak, resulting in fire, personal injury, or ambient pollution. Be sure to point the remote control at the remote control sensor on the TV. To remove the batteries, perform the installation actions in reverse. This remote uses infrared light. When in use, it should be pointed in the direction of the TV's remote sensor.

⚠ CAUTION

- Do not mix old and new batteries, as this may damage the remote control.

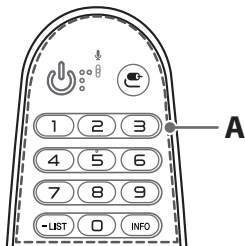

A

⏻ (POWER) Turns the TV on or off.

📺 (INPUT) Changes the input source.

- * Pressing and holding the **📺 (INPUT)** button displays all the lists of external inputs.

Number buttons Enters numbers.

— (DASH) Inserts a dash between numbers such as 2-1 and 2-2.

LIST Accesses the saved channel list.

INFO Views the information of the current channels and screen.

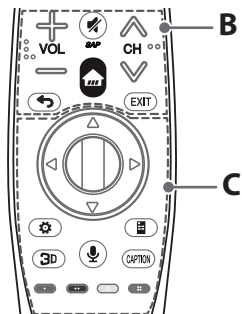

B

+ VOL - Adjusts the volume level.

🔇 (MUTE) Mutes all sounds.

- * By pressing and holding the **🔇** button, video descriptions function will be enabled.

- * **SAP** (Secondary Audio Program) Feature can also be enabled by pressing the **🔇** key.

^ CH v Scrolls through the saved channels.

🏠 (Home) Accesses the Home menu.

← (BACK) Returns to the previous screen.

EXIT Clears all on-screen displays and returns to TV viewing.

C

⦿ Wheel (OK) Press the center of the Wheel button to select a menu. You can change channels by using the Wheel button.

△▽◀▶ (up/down/left/right) Press the up, down, left or right button to scroll the menu. If you press △▽◀▶ buttons while the pointer is in use, the pointer will disappear from the screen and Magic Remote will operate like a general remote control. To display the pointer on the screen again, shake Magic Remote to the left and right.

⚙ (Q. Settings) Accesses the Quick Settings.

- * Pressing and holding the **⚙ (Q. Settings)** button displays the **Advanced** menu.

📺 (Screen remote) Displays the Screen Remote.

- * Accesses the Universal Control Menu in some regions.

3D Used for viewing 3D video. (For 3D models)

🗣 (Voice recognition)

Network connection is required to use the voice recognition function.

1. Press the voice recognition button.

2. Speak when the voice display window appears on the TV screen.

- * Use the Magic Remote no further than 10 cm (4 inches) from your face.

- * The voice recognition may fail when you speak too fast or too slowly.



- * The recognition rate may vary depending upon the user's characteristics (voice, pronunciation, intonation, and speed) and the environment (noise and TV volume).

CAPTION Activates or deactivates the subtitles.





Color buttons These access special functions in some menus. (● Red, ● Green, ● Yellow, ● Blue)

Registering Magic Remote





How to register the Magic Remote

 (Wheel)	<p>To use the Magic Remote, first pair it with your TV.</p> <ol style="list-style-type: none">Put batteries into the Magic Remote and turn the TV on.Point the Magic Remote at your TV and press the  Wheel (OK) on the remote control. <p>* If the TV fails to register the Magic Remote, try again after turning the TV off and back on.</p>
--	---

How to deregister the Magic Remote

 (BACK)	<p>Press the  (BACK) and  (Home) at the same time, for five seconds, to unpair the Magic Remote with your TV. Pressing and holding the EXIT button will let you cancel and re-register Magic Remote at once.</p>
 (Home)	

How to use Magic Remote

	<ul style="list-style-type: none">Shake the Magic Remote slightly to the right and left or press  (Home),  (INPUT),  buttons to make the pointer appear on the screen. (In some TV models, the pointer will appear when you turn the Wheel button.)If the pointer has not been used for a certain period of time or Magic Remote is placed on a flat surface, then the pointer will disappear.If the pointer does not move as you wish, shake Magic Remote to the left and right. The pointer will move to the center of the screen.The Magic Remote depletes batteries faster than a normal remote due to the additional features.
---	---

Precautions to Take

- Use the remote control within the specified range (within 10 m, 32.8 ft). You may experience communication failures when using the device outside the coverage area or if there are obstacles within the coverage area.
- You may experience communication failures depending upon the accessories. Devices such as a microwave oven and wireless LAN operate in the same frequency band (2.4 GHz) as the Magic Remote. This may cause communication failures.
- The Magic Remote may not work properly if a wireless router (AP) is within 1 m (3.28 ft) of the TV. Your wireless router should be more than 1 m (3.28 ft) away from the TV.
- Do not disassemble or heat the battery.

- Do not drop the battery. Avoid extreme shocks to the battery.
- Inserting the battery in the wrong way may result in explosion.

Licenses

Supported licenses may differ by model. For more information about licenses, visit www.lg.com.



(For LF6300, LF6390, LF6500 series)



(For LF595B, LF5900, LF5950 series)



Open Source Software Notice Information

To obtain the source code under GPL, LGPL, MPL, and other open source licenses, that is contained in this product, please visit <http://opensource.lge.com>. In addition to the source code, all referred license terms, warranty disclaimers and copyright notices are available for download.

LG Electronics will also provide open source code to you on CD-ROM for a charge covering the cost of performing such distribution (such as the cost of media, shipping, and handling) upon email request to opensource@lge.com. This offer is valid for three (3) years from the date on which you purchased the product.

Troubleshooting

- Cannot control the TV with the remote control.
 - Check the remote control sensor on the product and try again.
 - Check if there is any obstacle between the product and the remote control.
 - Check if the batteries are still working and properly installed (⊕ to ⊕, ⊖ to ⊖)
- No image display and no sound is produced.
 - Check if the product is turned on.
 - Check if the power cord is connected to a wall outlet.
 - Check if there is a problem in the wall outlet by connecting other products.
- The TV turns off suddenly.
 - Check the power control settings. The power supply may be interrupted.
 - Check if the **Sleep Timer/Timer Power off** is activated in the **Timers** settings.
 - If there is no signal while the TV is on, the TV will turn off automatically after 15 minutes of inactivity.

Specifications

Product specifications may be changed without prior notice due to upgrade of product functions.

Television System

NTSC-M, ATSC, 64 & 256 QAM

Program Coverage

VHF 2-13, UHF 14-69, CATV 1-135, DTV 2-69, CADTV 1-135

External Antenna Impedance

75 Ω

Environment Condition

Operating Temperature 0 °C to 40 °C (32 °F to 104 °F)

Operating Humidity Less than 80 %

Storage Temperature -20 °C to 60 °C (-4 °F to 140 °F)

Storage Humidity Less than 85 %

Wireless Module Specifications

(For LF595B, LF5900, LF5950 series)

Wireless Module (WN8122E1) Specification	
Standard	IEEE802.11a/b/g/n
Frequency Range	2400 to 2483.5 MHz 5150 to 5250 MHz 5725 to 5850 MHz
Output Power (Max.)	802.11a : 16.5 dBm 802.11b : 16 dBm 802.11g : 15.5 dBm 802.11n - 2.4 GHz : 15.5 dBm 802.11n - 5 GHz : 16.5 dBm
<ul style="list-style-type: none"> • Because band channel used by the country could be different, the user can not change or adjust the operating frequency and this product is set for the regional frequency table. • This device should be installed and operated with minimum distance 20 cm (7.8 inches) between the device and your body. And this phrase is for the general statement for consideration of user environment. • Contains FCC ID: BEJWN8122E1 Contains IC: 2703H-WN8122E1 	

(For LF6300, LF6390, LF6500 series)

Wireless module (LGSBW41) Specifications		
	Wireless LAN	Bluetooth
Standard	IEEE 802.11a/b/g/n	Bluetooth Version 4.0
Frequency Range	2400 to 2483.5 MHz 5150 to 5250 MHz 5725 to 5850 MHz	2400 to 2483.5 MHz
Output Power (Max.)	802.11a: 11.5 dBm 802.11b: 11 dBm 802.11g: 10.5 dBm 802.11n - 2.4 GHz: 11 dBm 802.11n - 5 GHz: 12.5 dBm	10 dBm or Lower
<ul style="list-style-type: none"> • Because band channel used by the country could be different, the user can not change or adjust the operating frequency and this product is set for the regional frequency table. • This device should be installed and operated with minimum distance 20 cm (7.8 inches) between the device and your body. And this phrase is for the general statement for consideration of user environment. • Contains FCC ID: BEJLGSBW41 Contains IC: 2703H-LGSBW41 		



Declaration of Conformity

Trade Name	LG
Model	42LF6500-UB, 50LF6500-UB 55LF6500-UB, 40LF6300-UA, 43LF6300-UA 49LF6300-UA, 55LF6300-UA 60LF6300-UA, 65LF6300-UA 60LF6390-UA, 65LF6390-UA 32LF595B-UB, 43LF5900-UB 49LF5900-UB, 55LF5950-UB
Responsible Party	LG Electronics Inc.
Address	1000 Sylvan Ave. Englewood Cliffs NJ 07632 U.S.A
TEL	201 - 266 - 2534

LG Customer Information Center

For inquires or comments, visit www.lg.com or call;

1-888-542-2623	CANADA
1-800-243-0000	USA, Consumer User
1-888-865-3026	USA, Commercial User

Register your product Online!

www.lg.com

The model and serial number of the TV are located on the back and one side of the TV.

Record them below should you ever need service.

MODEL _____

SERIAL _____



ENGLISH

Easy Setup Guide

Please read this manual carefully before operating your set and retain it for future reference.

ESPAÑOL

Guía Rápida de Configuración

Lea atentamente este manual antes de poner en marcha el equipo y consérvelo para futuras consultas.

FRANÇAIS

Guide de configuration rapide

Avant d'utiliser l'appareil, veuillez lire attentivement ce manuel et le conserver pour pouvoir vous y reporter ultérieurement.

LED TV

40LF6300

43LF6300

49LF6300

55LF6300

60LF6300

65LF6300

60LF6390

65LF6390

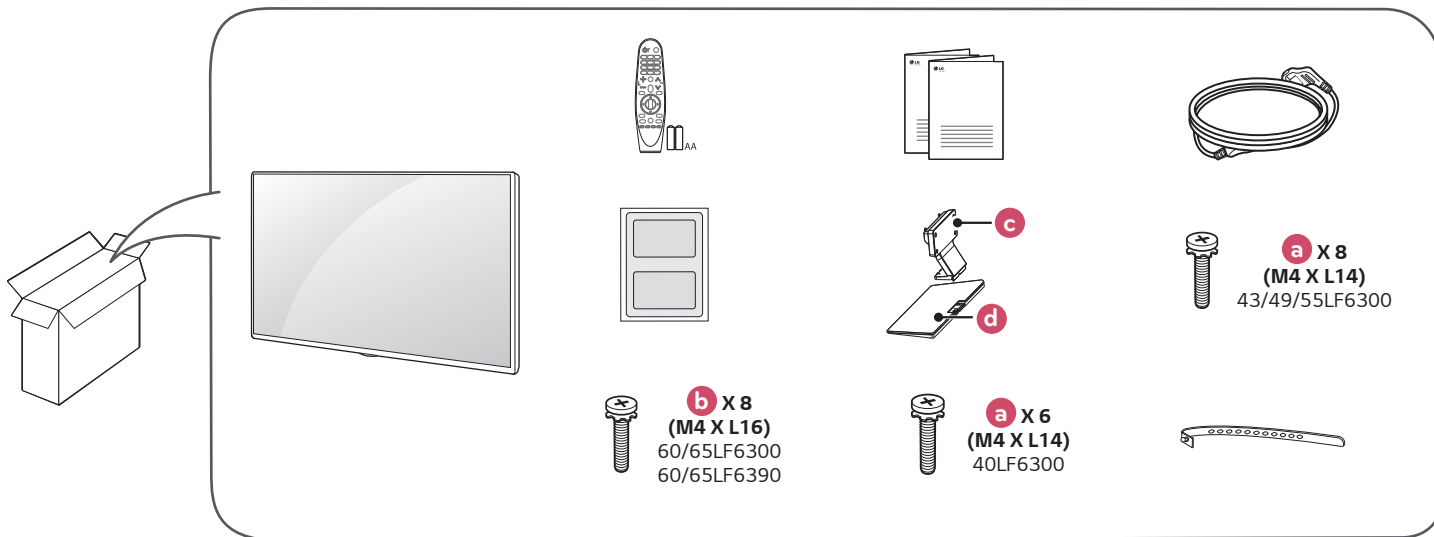

www.lg.com

P/No : MFL68683602 (1501-REV02)



ENGLISH Read Safety and Reference.
ESPAÑOL Leer Seguridad y Consultas.
FRANÇAIS Lisez Sécurité et références.

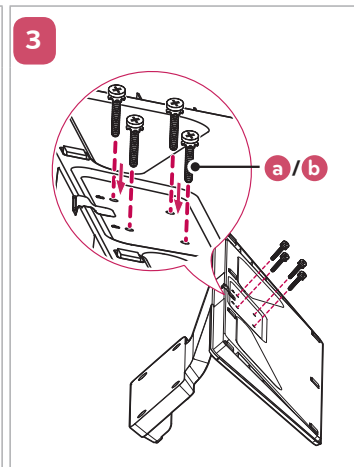
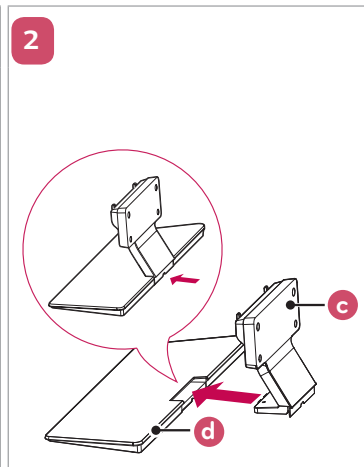
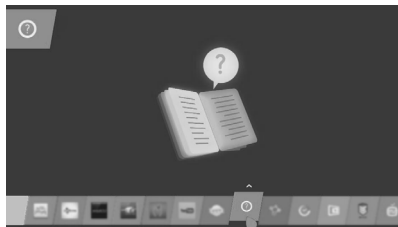
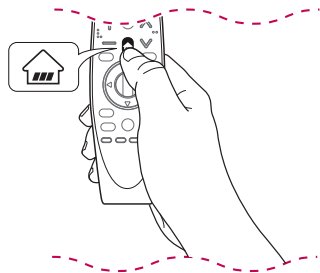

4-A 43/49/55/60/65LF6300,
60/65LF6390

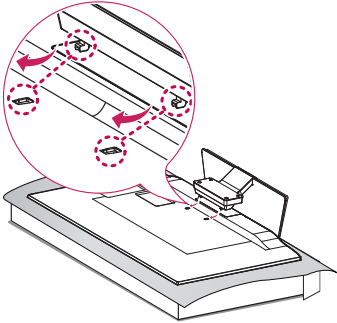

4-B 40LF6300

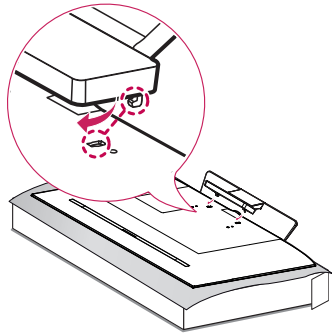

5-A 43/49/55/60/65LF6300,
60/65LF6390

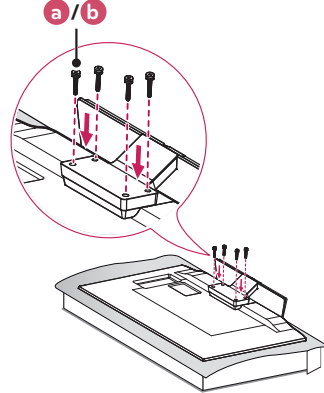

5-B 40LF6300

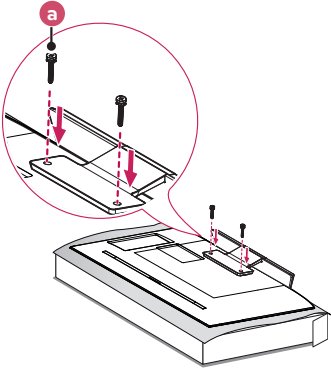

6

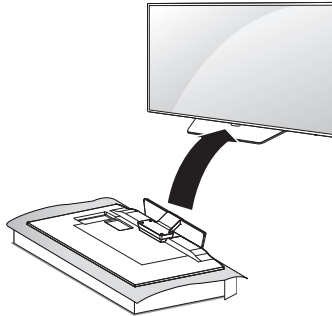

2

ENGLISH
ESPAÑOL
FRANÇAIS

Image shown may differ from your TV.
La imagen puede ser diferente a la de su televisor.
Cette illustration peut ne pas correspondre à votre téléviseur.

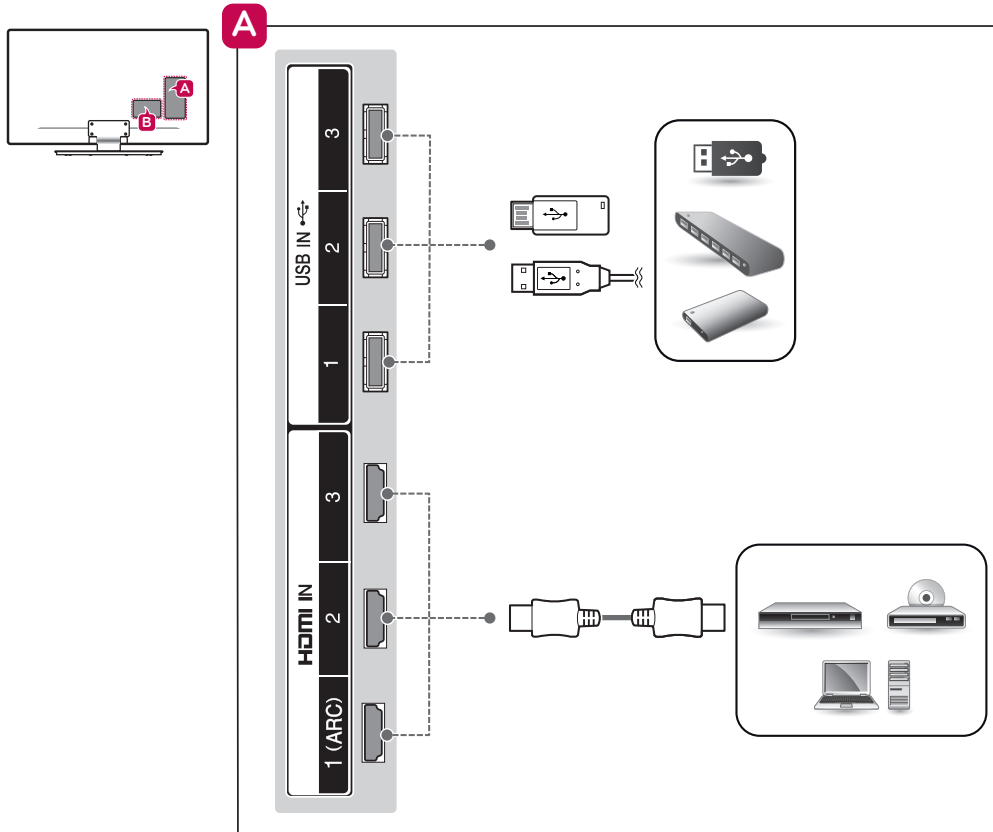

B

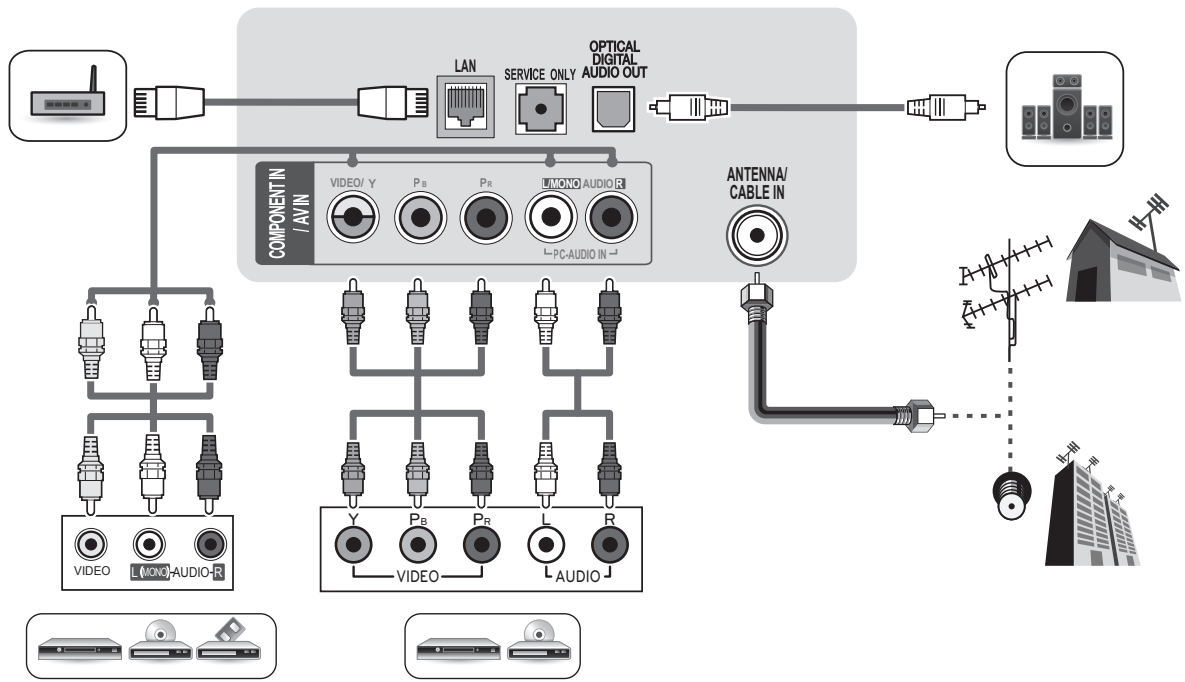

3

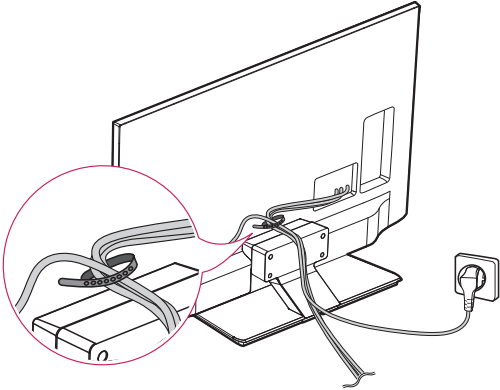

4

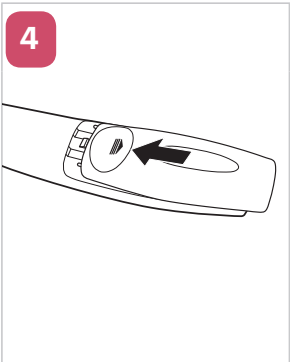
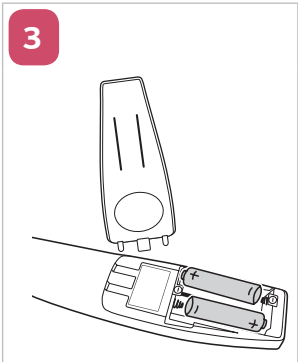
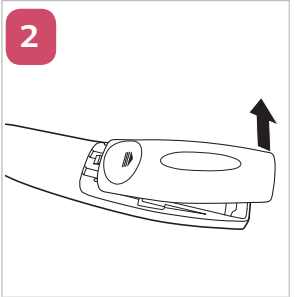
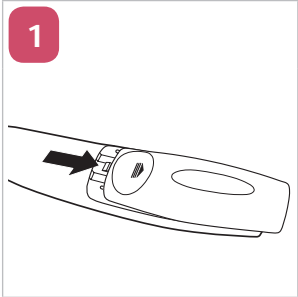

5

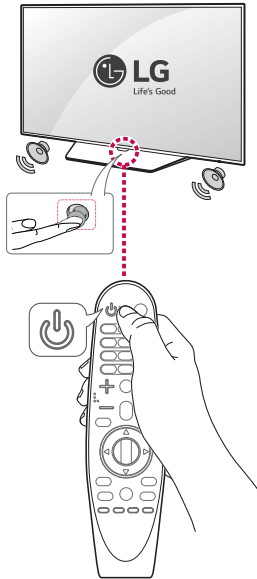

ENGLISH

MODELS		40LF6300 (40LF6300-UA)	43LF6300 (43LF6300-UA)	49LF6300 (49LF6300-UA)
Dimensions (W x H x D)	With stand	911 x 581 x 189 (mm) 35.8 x 22.8 x 7.4 (inches)	973 x 625 x 193 (mm) 38.3 x 24.6 x 7.5 (inches)	1,106 x 697.5 x 220 (mm) 43.5 x 27.4 x 8.6 (inches)
	Without stand	911 x 528 x 55.3 (mm) 35.8 x 20.7 x 2.1 (inches)	973 x 573 x 37 (mm) 38.3 x 22.5 x 1.4 (inches)	1,106 x 647 x 37 (mm) 43.5 x 25.4 x 1.4 (inches)
Weight	With stand	9.6 kg (21.1 lbs)	12.7 kg (27.9 lbs)	17.6 kg (38.8 lbs)
	Without stand	7.5 kg (16.5 lbs)	10.2 kg (22.4 lbs)	14.4 kg (31.7 lbs)
Power requirement		AC 100 - 240 V ~ 50 / 60 Hz		
Current Value / Power consumption		0.9 A / 90 W	1.0 A / 100 W	1.2 A / 120 W

MODELS		55LF6300 (55LF6300-UA)	60LF6300 (60LF6300-UA) 60LF6390 (60LF6390-UA)	65LF6300 (65LF6300-UA) 65LF6390 (65LF6390-UA)
Dimensions (W x H x D)	With stand	1,242 x 774 x 220 (mm) 48.8 x 30.4 x 8.6 (inches)	1,363 x 844 x 294 (mm) 53.6 x 33.2 x 11.5 (inches)	1,461 x 899 x 294 (mm) 57.5 x 35.3 x 11.5 (inches)
	Without stand	1,242 x 724 x 37 (mm) 48.8 x 28.5 x 1.4 (inches)	1,363 x 792 x 39 (mm) 53.6 x 31.1 x 1.5 (inches)	1,461 x 848 x 39 (mm) 57.5 x 33.3 x 1.5 (inches)
Weight	With stand	20.9 kg (46.0 lbs)	29.3 kg (64.5 lbs)	34 kg (74.9 lbs)
	Without stand	17.7 kg (39.0 lbs)	24.1 kg (53.1 lbs)	28.8 kg (63.4 lbs)
Power requirement		AC 100 - 240 V ~ 50 / 60 Hz		
Current Value / Power consumption		1.3 A / 130 W	1.5 A / 150 W	1.6 A / 160 W

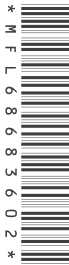

**ESPAÑOL
FRANÇAIS**

MODELOS MODÈLES		40LF6300 (40LF6300-UA)	43LF6300 (43LF6300-UA)	49LF6300 (49LF6300-UA)
Dimensiones (Ancho x altura x profundidad)	Con base	911 x 581 x 189 (mm) 35,8 x 22,8 x 7,4 (pulgadas / pouces)	973 x 625 x 193 (mm) 38,3 x 24,6 x 7,5 (pulgadas / pouces)	1 106 x 697,5 x 220 (mm) 43,5 x 27,4 x 8,6 (pulgadas / pouces)
	Avec support			
Dimensions (L x H x P)	Sin base	911 x 528 x 55,3 (mm) 35,8 x 20,7 x 2,1 (pulgadas / pouces)	973 x 573 x 37 (mm) 38,3 x 22,5 x 1,4 (pulgadas / pouces)	1 106 x 647 x 37 (mm) 43,5 x 25,4 x 1,4 (pulgadas / pouces)
	Sans support			
Peso	Con base Avec support	9,6 kg (21,1 libras / lb)	12,7 kg (27,9 libras / lb)	17,6 kg (38,8 libras / lb)
Poids	Sin base Sans support	7,5 kg (16,5 libras / lb)	10,2 kg (22,4 libras / lb)	14,4 kg (31,7 libras / lb)
Potencia requerida		AC 100 - 240 V ~ 50 / 60 Hz		
Alimentation		AC 100 - 240 V ~ 50 / 60 Hz		
Corriente de consumo / Consumo de la potencia		0,9 A / 90 W	1,0 A / 100 W	1,2 A / 120 W
Valeur courante / Consommation électrique				

(For USA and Canada Only)

(Para Estados Unidos y Canadá)



This product qualifies for ENERGY STAR in the "factory default (Home Use)" setting.

Changing the factory default settings or enabling other features may increase power consumption that could exceed the limits necessary to qualify for ENERGY STAR. Refer to ENERGY STAR.gov for more information on the ENERGY STAR program.

(Pour les États-Unis et le Canada)



Ce produit est conforme aux normes ENERGY STAR lorsque le « réglage d'usine par défaut (résidentiel) » est sélectionné.

Modifier les réglages d'usine par défaut ou activer d'autres fonctionnalités augmente la consommation d'énergie qui pourrait alors dépasser les limites de la qualification Energy Star. Consultez le site ENERGYSTAR.gov pour en savoir plus au sujet du programme ENERGY STAR.

MODELOS MODÈLES		55LF6300 (55LF6300-UA)	60LF6300 (60LF6300-UA)	65LF6300 (65LF6300-UA)
			60LF6390 (60LF6390-UA)	65LF6390 (65LF6390-UA)
Dimensiones (Ancho x altura x profundidad)	Con base	1 242 x 774 x 220 (mm) 48,8 x 30,4 x 8,6 (pulgadas / pouces)	1 363 x 844 x 294 (mm) 53,6 x 33,2 x 11,5 (pulgadas / pouces)	1 461 x 899 x 294 (mm) 57,5 x 35,3 x 11,5 (pulgadas / pouces)
	Avec support			
Dimensions (L x H x P)	Sin base	1 242 x 724 x 37 (mm) 48,8 x 28,5 x 1,4 (pulgadas / pouces)	1 363 x 792 x 39 (mm) 53,6 x 31,1 x 1,5 (pulgadas / pouces)	1 461 x 848 x 39 (mm) 57,5 x 33,3 x 1,5 (pulgadas / pouces)
	Sans support			
Peso	Con base Avec support	20,9 kg (46,0 libras / lb)	29,3 kg (64,5 libras / lb)	34 kg (74,9 libras / lb)
Poids	Sin base Sans support	17,7 kg (39,0 libras / lb)	24,1 kg (53,1 libras / lb)	28,8 kg (63,4 libras / lb)
Potencia requerida		AC 100 - 240 V ~ 50 / 60 Hz		
Alimentation		AC 100 - 240 V ~ 50 / 60 Hz		
Corriente de consumo / Consumo de la potencia		1,3 A / 130 W	1,5 A / 150 W	1,6 A / 160 W
Valeur courante / Consommation électrique				