

* Image shown may differ from your TV.

* Image shown on a PC or mobile phone may vary depending on the Operating System (OS).

Wireless Network Connection



Wired Network Connection

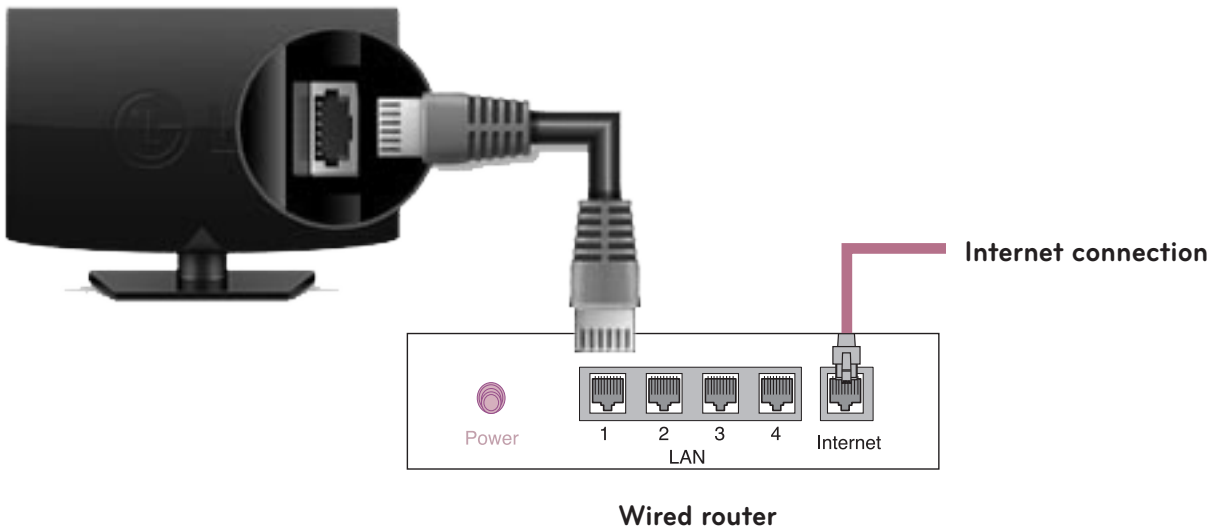

NETWORK SETTING

Premium Apps are pre-installed on the TV. These may vary by country.

ENGLISH

- 1 Press the **SMART**  button to access the Home menu. Select **Settings** and press **Wheel(OK)**.

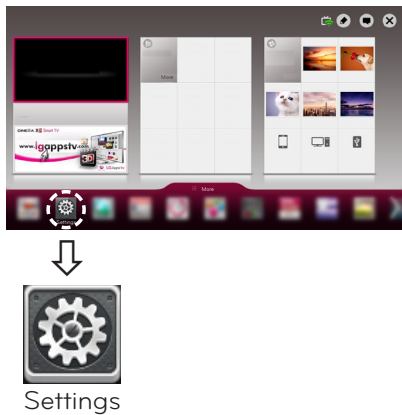

- 2 Select the **NETWORK** **Network Connection** menu.



- 3 Select the **Start Connection**.

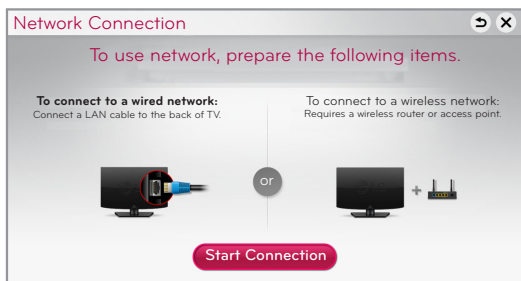

- 4 The device automatically tries to connect to the network available (wired network first).

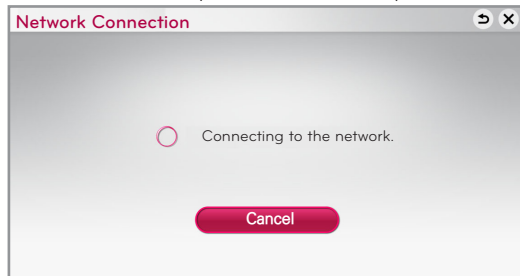

If you select **Cancel** or it fails to connect to the network, the network list available is displayed. Choose the network you wish to use.

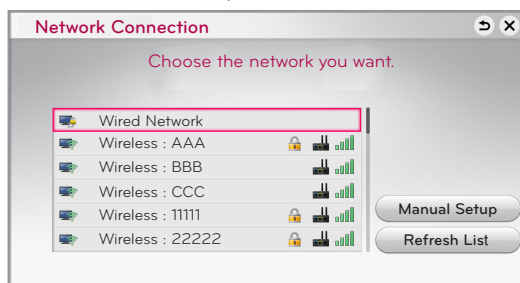

For wireless AP(Router) that have the  symbol, you need to enter the security key.

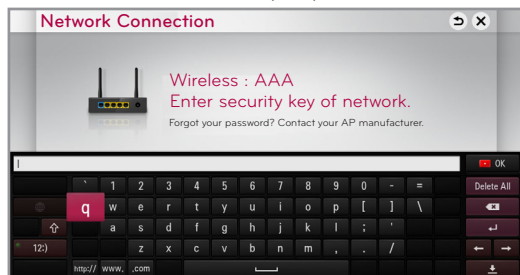

- 5 The connected network is displayed. Select **Complete** to confirm the network connection. If you select the **Other Network List**, the available network list is displayed again.

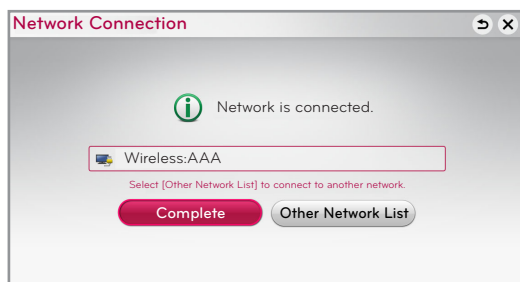

Troubleshooting Network Problems

- 1 Press the **SMART**  button to access the Smart Home menu. Select **Settings** and press **Wheel(OK)**.

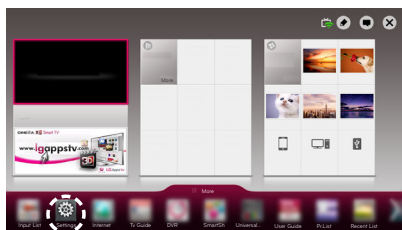

- 2 Select the **NETWORK** → **Network Status** menu.

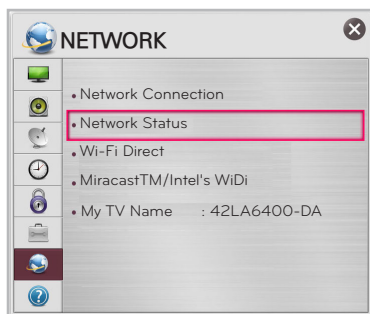

Follow the instructions below that correlate to your network status.

Check the TV or the AP(Router).

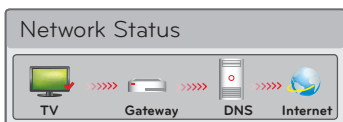

When an ✓ appears on TV, but an X on Gateway.

- 1 Check the connection status of the TV, AP(Router) and cable modem.
- 2 Power off and power on the TV, AP(Router) and cable modem.
- 3 If you are using a static IP, enter the IP directly.
- 4 Contact internet companies or AP(Router) companies.
 - Additional points to check when using a wireless connection
 - 1 Check the password for the wireless connection in the AP(Router) settings window.
 - 2 Change the AP(Router) SSID (network name) or the wireless channel.

Check the AP(Router) or consult your Internet service provider.



When an ✓ appears on TV and Gateway, but an X on DNS.

- 1 Unplug the power cord of the AP(Router), cable modem and try to connect after 5 seconds.
- 2 Initialize(Reset) the AP(Router) or cable modem.
- 3 Contact internet companies or AP(Router) companies.

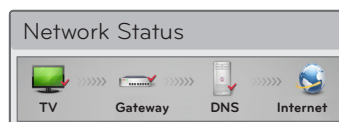

When an ✓ appears on TV, Gateway and DNS, but an X on Internet.

- 1 Unplug the power cord of the AP(Router), cable modem and try to connect after 5 seconds.
- 2 Initialize(Reset) the AP(Router) or cable modem.
- 3 Check that the MAC address of the TV/AP(Router) is registered with your Internet service provider. (The MAC address displayed on the right pane of the network status window should be registered with your Internet service provider.)
- 4 Check the AP(Router) manufacturer's website to make sure your router has the latest firmware version installed.

SmartShare PC SW Installation & Setting

Install the **SmartShare PC SW(DLNA)** and **SmartShare PC SW(MediaLink)** program on your PC.

- 1 Go to **www.lg.com**. Then, select your region.
- 2 Select **SUPPORT**. Then, search for your model.
- 3 Select **Drivers & Software** or **SOFTWARE UPDATE**. Then, select **SmartShare PC SW(DLNA)**
- 4 You can run the program when installation is complete.



NOTE

- DLNA service is only available if TV and other devices are connected via a single AP(Router).

DLNA Connection to Smartphone

- 1 Check that Wi-Fi is enabled on your smartphone. To use DLNA, both devices must be on the same local network.
- 2 Install/run the app for sharing content on your smartphone (It's called SmartShare on LG phones).
- 3 Enable your smartphone to share content files with other devices.
- 4 Select the file type you want to play (movie, audio or photo).
- 5 Select a movie, music or photo file to play on the TV.
- 6 Add the selected file to the playlist.
- 7 Select a TV model name on which to play the files. (The TV model name is on a label on the side of the TV and in the customer support menu.)
- 8 Play the media file to view and enjoy it on your TV.

Updating the TV Firmware

HOME →  Settings → SUPPORT → Software Update

By default, the TV will notify you of new software updates. You can use the Software Update menu to manually check for available updates.

Software Update	Set it to On . When an updated file is detected, the file is downloaded automatically.
Automatic Update Mode	If an update is available, the update automatically starts without prompting.
Check Update Version	Checks the latest update version installed. When a new update is available, the download process can be performed manually.

Tag On

(Depending on model)

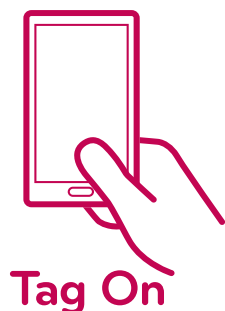

Tag On is a data transmission technology that can be used on smartphones with NFC (Near Field Communication). Simply by tapping your smartphone to a Tag On sticker, you can share content between your smartphone and TV.

- To connect your smartphone to the TV using Tag On, they must be connected on the same Wi-Fi network or **Miracast™/Intel's WiDi** of the smart TV is set to **On**.

- Do not attach the sticker to a metal part of the TV. Otherwise, your smartphone cannot recognize the Tag On sticker.
- Do not crumple or fold the Tag On sticker. Otherwise, the Tag On is not recognized.
- To purchase a Tag On sticker, please contact the LG Electronics Service Center.
- This function is supported only on a smartphone with Android 4.0 (ICS) or later.

Wi-Fi Direct Setting

HOME →  Settings → NETWORK → Wi-Fi Direct

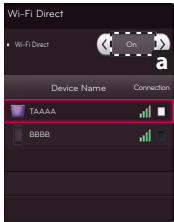

If a local network is not available, you can connect a portable device directly to the TV using Wi-Fi Direct. With Smart Share, you can share files or screens of devices connected to **Wi-Fi Direct**.

[Device Screen]

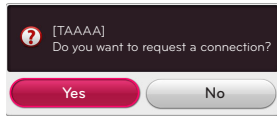

[TV Screen]



- 1 If **Wi-Fi Direct** is set to **On**, a list of available devices appears.
» To use **Wi-Fi Direct**, go to  **Settings** → **NETWORK** and set **Wi-Fi Direct**  to **On**.
- 2 When you are prompted to request connection, select **Yes**. **Wi-Fi Direct** is now connected to your TV.

*If you are not using **Wi-Fi Direct** to minimize the interference between Wi-Fi devices, it is recommended to set **Wi-Fi Direct**  to **Off**. You can only use devices that support **Wi-Fi Direct**.

Miracast™ Setting

Miracast allows a portable device to securely send video and sound to the TV wirelessly.

[Device Screen]

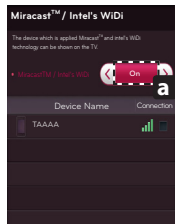

- 1 Miracast should be set to 'ON' on your mobile device And TV. Go to the Network settings to set the Miracast.
- 2 When your TV or portable device is detected, select the device.

WiDi (Wireless Display) Setting

Intel's WiDi (Wireless Display) technology enables easy and fast connection without wires or internet network for mirrored and dual monitor display on your TV. You can sit back and experience your favorite movies, videos, photos, online shows and more in full HD on your TV with great image clarity and sound.

NOTE

- When you connect the TV and laptop, you should set up TV mode for "Live TV" and " external input". If not, your computer cannot detect LG Smart TV.

- 1 Intel's WiDi is set to On. Connect your laptop to AP(Router). (Without AP, it is possible to use this function; it is recommended to connect to AP.) Your laptop runs the Intel WiDi program.
- 2 It detects LG Smart TVs available, which supports WiDi. In the list, select the TV you want and click Connect. Enter the number **(a)** shown on the screen into the input field **(b)** on your laptop and then click Continue. (4-digit number: under WiDi 3.1.29, 8-digit number: above WiDi 3.5)

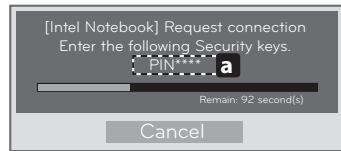
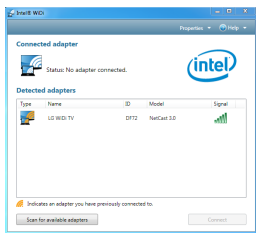

[TV Screen]



[Laptop Screen]

- 3 The TV screen appears on the laptop screen. The wireless environment may affect the screen display. If the connection is poor, the Intel WiDi connection may be lost.
- * LG TVs do not need to register.
 - * TV sound setting for **Digital Sound Out** is set to **PCM**.
 - * For more information on Intel WiDi, visit '<http://intel.com/go/widi>'.
 - * On the **Intel's WiDi**, WiDi device is not searched. Close the **Intel's WiDi**, then search WiDi.
 - * You can control your PC using the Magic Remote Control.
 - * Intel's WiDi laptop is not appeared in the Miracast /WiDi menu in TV network menu.

On-Screen Remote

To use the Universal Control function (It may not be available depending on the country/model.)

With the Magic Remote Control, you can easily control your set-top box, Blu-ray player, home theater system, and Sound Bar.

- 1 Check if the device is connected to the TV.
- 2 After pressing the '123 /Q.MENU' button on the Magic Remote Control, select the device you want to control in the Change Device tab. The Screen Remote that can control the device appears.



- 3 You can control external devices using the Screen Remote on the screen. (This may not work with the '123 /Q.MENU' button for some models.)



- » **a**: Change Device tab
- » **b**: Device control buttons
- » **c**: Expand the ScreenRemote
- » **d**: Exits the Screen Remote
- » **e**: Moves the position of the ScreenRemote to left or right

- 4 Control external devices using the navigation keys, wheel (OK), or BACK button on the Magic Remote Control.

