

Quick start guide

LG-V500

To download the latest full version of the user guide, go to www.lg.com on your PC or laptop.



CE0168

www.lg.com

MBM64358426 (1.0)

Overview

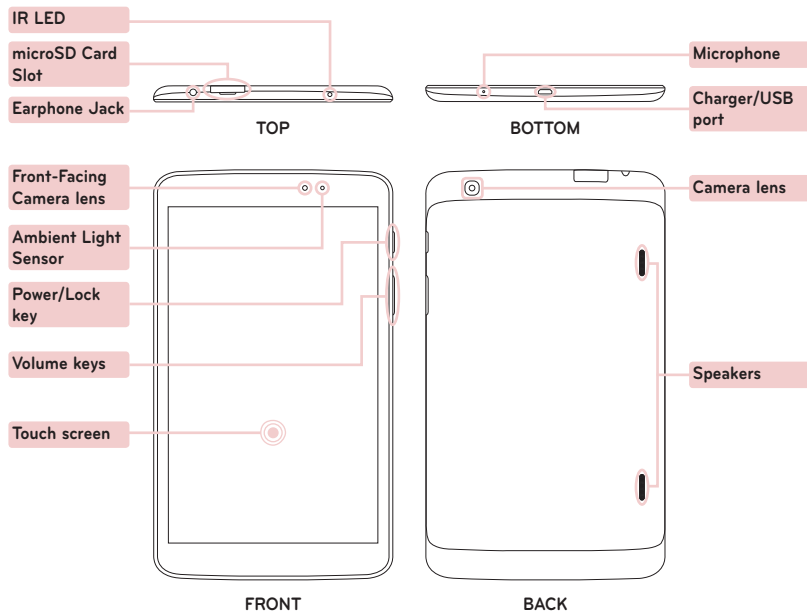

Installing the memory card

The memory card slot is located at the top of the tablet.



- 1 Turn the tablet off before inserting or removing the memory card.
- 2 Place your fingernail in the cutout and pull the memory card tray out. Insert the memory card into the slot with the contacts facing down. Carefully push the tray gently into the tablet.

NOTE: Do not remove the microSD card without unmounting it first. Otherwise the memory card, as well as your tablet, may become damaged and the data stored on the memory card may get corrupted. To remove the memory card safely, touch  > **Apps** tab > **Settings** > **Storage** from the DEVICE > **Unmount SD card**.

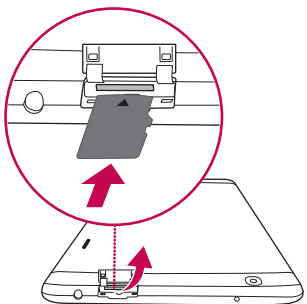

Turning on your tablet

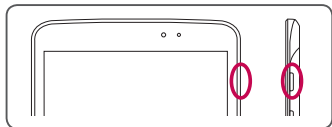

Press and hold the **Power/Lock Key**  for a couple of seconds.

TIP! If the device is locked and does not work, press and hold the **Power/Lock Key**  for 8 seconds to turn it off.

Charging the tablet

NOTE: For your safety, do not remove the battery incorporated in the product. If you need to replace the battery, take it to the nearest authorized LG Electronics service point or dealer for assistance.

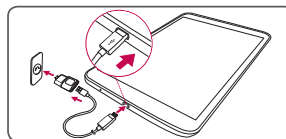

- The charging port is at the bottom of the tablet.
- Insert one end of the charging cable into the tablet and the other end into the charger, then plug the charger into an electrical socket.
- To maximize the battery lifetime, ensure that the battery is fully charged before you use it for the first time.

WARNING! Use only LG-approved charging accessories. When using unapproved chargers or cables, it may cause battery slow charging or pop up the message regarding charging delay. Or, unapproved chargers or cables can cause the battery to explode or damage the device, which are not covered by the warranty.

QPair

By connecting your tablet and mobile phone via QPair, you can sync incoming calls, messages, and social networking notifications between your tablet and mobile phone.



- 1 Run **QPair**  and tap **Get started** > **Start** on your tablet first and then run the same steps on your phone.

TIP! QPair may not be pre-installed on the phone. Go to Google Play Store and search for Qpair and install.

NOTE: QPair works with phones running Android 4.1 or later. Some features may be limited depending on your phone model.

- 2 Bluetooth connection will be turned on automatically.

Guidelines for safe and efficient use

Please read these simple guidelines. Not following these guidelines may be dangerous or illegal.

Exposure to radio frequency energy

Radio wave exposure and Specific Absorption Rate (SAR) information.

This tablet device model LG-V500 has been designed to comply with applicable safety requirements for exposure to radio waves. These requirements are based on scientific guidelines that include safety margins designed to assure the safety of all persons, regardless of age and health.

- The radio wave exposure guidelines employ a unit of measurement known as the Specific Absorption Rate (SAR). Tests for SAR are conducted using standardised methods with the device transmitting at its highest certified power level in all used frequency bands.
- While there may be differences between the SAR levels of various LG device models, they are all designed to meet the relevant guidelines for exposure to radio waves.
- The SAR limit recommended by the International Commission on Non-Ionizing Radiation Protection (ICNIRP) is 2 W/kg averaged over 10 g of tissue.
- The highest SAR value for this device when worn on the body, as described in this user guide, is 0.720 W/kg.
- This device meets RF exposure guidelines.

Product care and maintenance



WARNING

Notice for Battery replacement

- For your safety, do not remove the battery incorporated in the product. If you need to replace the battery, take it to the nearest authorized LG Electronics service point or dealer for assistance.
- Li-Ion Battery is a hazardous component which can cause injury.
- Battery replacement by non-qualified professional can cause damage to your device.

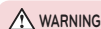

WARNING

Only use batteries, chargers and accessories approved for use with this particular device model. The use of any other types may void any approval or warranty applying to the device and may be dangerous.

- Do not disassemble this unit. Take it to a qualified service technician when repair work is required.
- Repairs under warranty, at LG's discretion, may include replacement parts or boards that are either new or reconditioned, provided that they have functionality equal to that of the parts being replaced.
- Keep away from electrical appliances such as TVs, radios and personal computers.
- The unit should be kept away from heat sources such as radiators or cookers.
- Do not drop.
- Do not subject this unit to mechanical vibration or shock.
- Switch off the device in any area where you are required to by special regulations. For example, do not use your device in hospitals as it may affect sensitive medical equipment.
- Do not handle the device with wet hands while it is being charged. It may cause an electric shock and can seriously damage your device.
- Do not charge a device near flammable material as the device can become hot and create a fire hazard.
- Use a dry cloth to clean the exterior of the unit (do not use solvents such as benzene, thinner or alcohol).
- Do not charge the tablet when it is on soft furnishings.
- The device should be charged in a well ventilated area.
- Do not subject this unit to excessive smoke or dust.
- Do not keep the device next to credit cards or transport tickets; it can affect the information on the magnetic strips.
- Do not tap the screen with a sharp object as it may damage the tablet.
- Do not expose the device to liquid or moisture.
- Use accessories like earphones cautiously. Do not touch the antenna unnecessarily.
- Do not use, touch or attempt to remove or fix broken, chipped or cracked glass. Damage to the glass display due to abuse or misuse is not covered under the warranty.
- Your tablet is an electronic device that generates heat during normal operation. Extremely prolonged, direct skin contact in the absence of adequate ventilation may result in discomfort or minor burns. Therefore, use care when handling your device during or immediately after operation.
- If your device gets wet, immediately turn it off and dry it out completely. Do not attempt to accelerate the drying process with an external heating source, such as an oven, microwave or hair dryer.
- The liquid in your wet device, changes the color of the product label inside your device. Damage to your device as a result of exposure to liquid is not covered under your warranty.
- Use your tablet in temperatures between 0 °C and 40 °C, if possible. Exposing your device to extremely low or high temperatures may result in damage, malfunction, or even explosion.

Guidelines for safe and efficient use

- Some hearing aids might be disturbed by tablet device.
- Minor interference may affect TVs, radios, PCs etc.

Road safety

Check the laws and regulations on the use of tablet device in the area when you drive.

- Do not use a hand-held device while driving.
- Give full attention to driving.
- RF signals may affect some electronic systems in your vehicle such as car stereos and safety equipment.
- When your vehicle is equipped with an air bag, do not obstruct with installed or portable wireless equipment. It can cause the air bag to fail or cause serious injury due to improper performance.
- If you are listening to music whilst out and about, please ensure that the volume is at a reasonable level so that you are aware of your surroundings. This is of particular importance when near roads.

Avoid damage to your hearing

NOTE: Excessive sound pressure from earphones and headphones can cause hearing loss.



To prevent possible hearing damage, do not listen at high volume levels for long periods.

- Damage to your hearing can occur if you are exposed to loud sound for long periods of time. We therefore recommend that you do not turn on or off the tablet close to your ear. We also recommend that music volumes are set to a reasonable level.
- When using headphones, turn the volume down if you cannot hear the people speaking near you, or if the person sitting next to you can hear what you are listening to.

Efficient device operation

Electronics devices

All tablet device may receive interference, which could affect performance.

- Do not use your tablet device near medical equipment without requesting permission. Avoid placing the tablet over pacemakers, for example, in your breast pocket.

Guidelines for safe and efficient use

Glass Parts

Some parts of your tablet device are made of glass. This glass could break if your device is dropped on a hard surface or receives a substantial impact. If the glass breaks, do not touch or attempt to remove it. Stop using your device until the glass is replaced by an authorised service provider.

Blasting area

Do not use the tablet where blasting is in progress. Observe restrictions and follow any regulations or rules.

Potentially explosive atmospheres

- Do not use your tablet at a refueling point.
- Do not use near fuel or chemicals.
- Do not transport or store flammable gas, liquid or explosives in the same compartment of your vehicle as your tablet device or accessories.

In aircraft

Wireless devices can cause interference in aircraft.

- Turn your tablet off before boarding any aircraft.
- Do not use it on the ground without permission from the crew.

Children

Keep the device in a safe place out of the reach of small children. It includes small parts which may cause a choking hazard if detached. This device also contains an internal battery that can be hazardous if the device is not used or maintained properly.

Battery information and care

- You do not need to completely discharge the battery before recharging. Unlike other battery systems, there is no memory effect that could compromise the battery's performance.
- Use only LG batteries and chargers. LG chargers are designed to maximise the battery life.
- Do not disassemble or short-circuit the battery.
- Recharge the battery if it has not been used for a long time to maximise usability.
- Do not expose the battery charger to direct sunlight or use it in high humidity, such as in the bathroom. Do not leave the device in hot or cold places, as this may deteriorate battery performance.
- There is risk of explosion if the battery is replaced with an incorrect type.
- Dispose of used batteries according to the manufacturer's instructions. Please recycle when possible. Do not dispose as household waste.
- If you need to replace the battery, take it to the nearest authorised LG Electronics service point or dealer for assistance.
- Always unplug the charger from the wall socket after the tablet is fully charged to save unnecessary power consumption of the charger.
- Actual battery life will depend on network configuration, product settings, usage patterns, battery and environmental conditions.
- Make sure that no sharp-edged items such as animal's teeth or nails, come into contact with the battery. This could cause a fire.
- For your safety, do not remove the battery incorporated in the product.

Guidelines for safe and efficient use

Driver Safety Tips

Check the laws and regulations on the use of wireless devices in the areas where you drive and always obey them. Also, if using your device while driving, please observe the following:

- Give full attention to driving. Driving safely is your first responsibility.
- Use hands-free operation, if available;
- Pull off the road and park before using it.

How to update your tablet

Access to latest firmware releases, new software functions and improvements.

- **Update your tablet without a PC. Select Update Center**
 **> Software Update.**
- **Update your tablet by connecting it to your PC.**

For more information about using this function, please visit <http://www.lg.com/common/index.jsp> select country and language.

Notice: Open Source Software

To obtain the corresponding source code under GPL, LGPL, MPL and other open source licences, please visit <http://opensource.lge.com/>

All referred licence terms, disclaimers and notices are available for download with the source code.

DECLARATION OF CONFORMITY

Hereby, **LG Electronics** declares that this **LG-V500** product is in compliance with the essential requirements and other relevant provisions of Directive **1999/5/EC**.

A copy of the Declaration of Conformity can be found at <http://www.lg.com/global/declaration>

This product is not suitable for people who have a visual impairment due to the touch screen keyboard.

Regulatory and Safety

Go to "**System settings > About tablet > Regulatory and Safety**" to get regulatory and safety information

NOTE:

- Screen displays and illustrations may differ from those you see on actual device.
- Some of the contents in this guide may differ from your device depending on the software of the device. All information in this document is subject to change without notice.
- Always use genuine LG accessories. Failure to do this may void your warranty.
- Available accessories may vary depending on your region or country.
- Some features and service may vary by region, device and software version.