

**MUSICflow** HS9  
SMART Hi-Fi AUDIO  
Wireless Multi-room Sound Bar

Model: LAS950M

ENGLISH | SIMPLE MANUAL (1 of 2)

To view the instructions of advanced features, visit <http://www.lg.com> and then download Owner's Manual. Some of the content in this manual may differ from your unit.

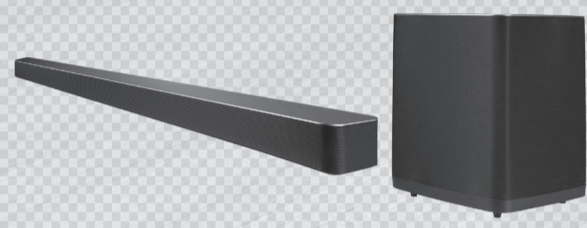

[www.lg.com](http://www.lg.com)

Unpacking

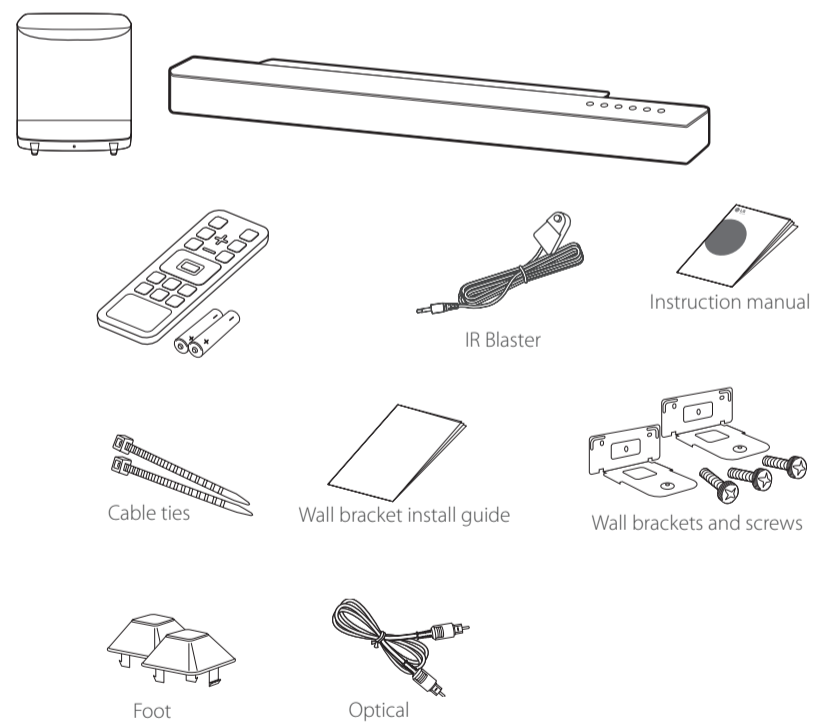

Optical operation

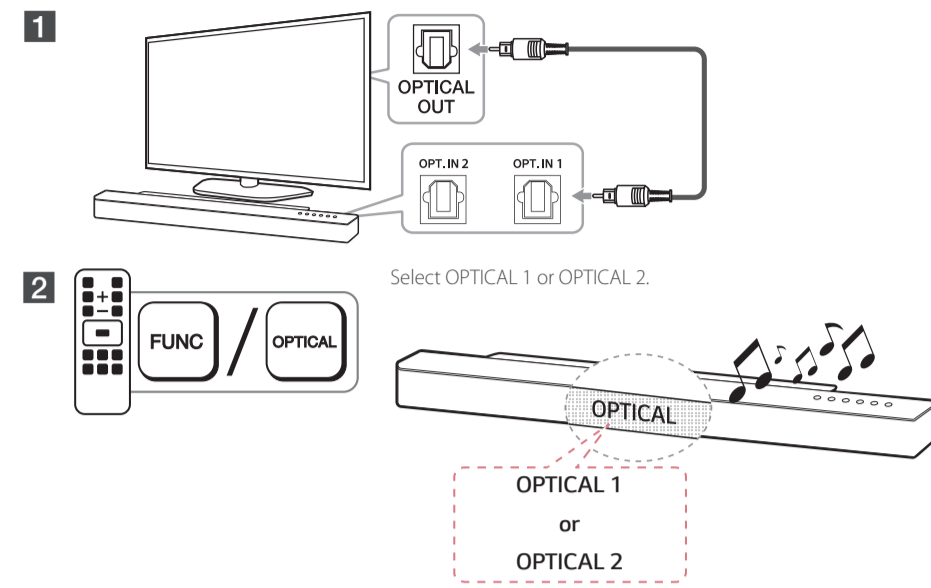

**!** You may need to change some Television's Sound Output settings. Refer to the description below.

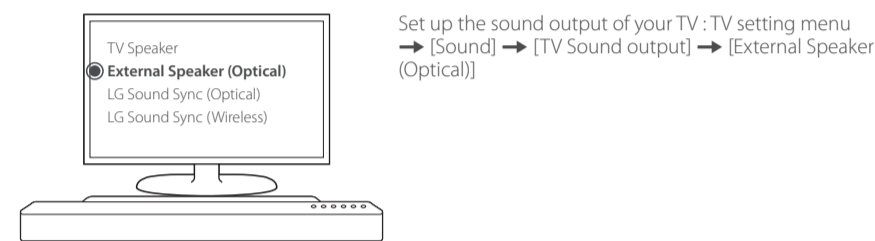

**!** Details of TV setting menu vary depending on the manufacturers or models of your TV.

LG Sound Sync

LG Sound Sync enables you to control some functions of this unit by a remote control of your LG TV. Controllable functions are volume up/down and mute. Make sure that your TV has LG Sound Sync logo as shown above.

Optical

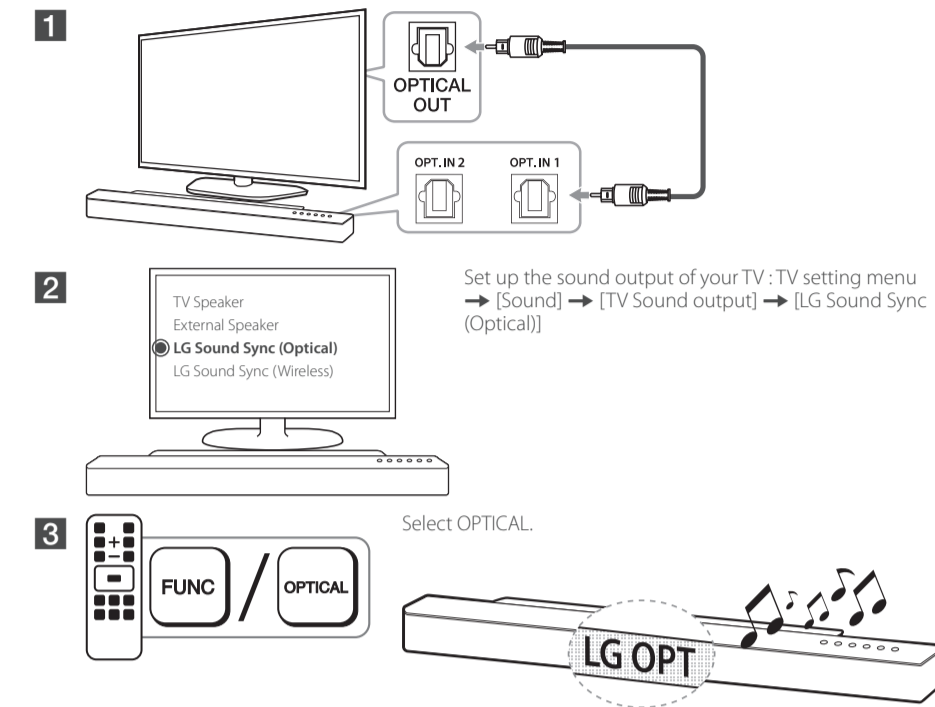

**!** For specific information of operating, refer to the instruction manual of your TV.

**!** When the connection fails, check the condition of this unit and your TV's : power, function and cable connections.

**!** The amount of time to turn off this unit is different depending on your TV when you set AUTO POWER function to ON.

HDMI operation

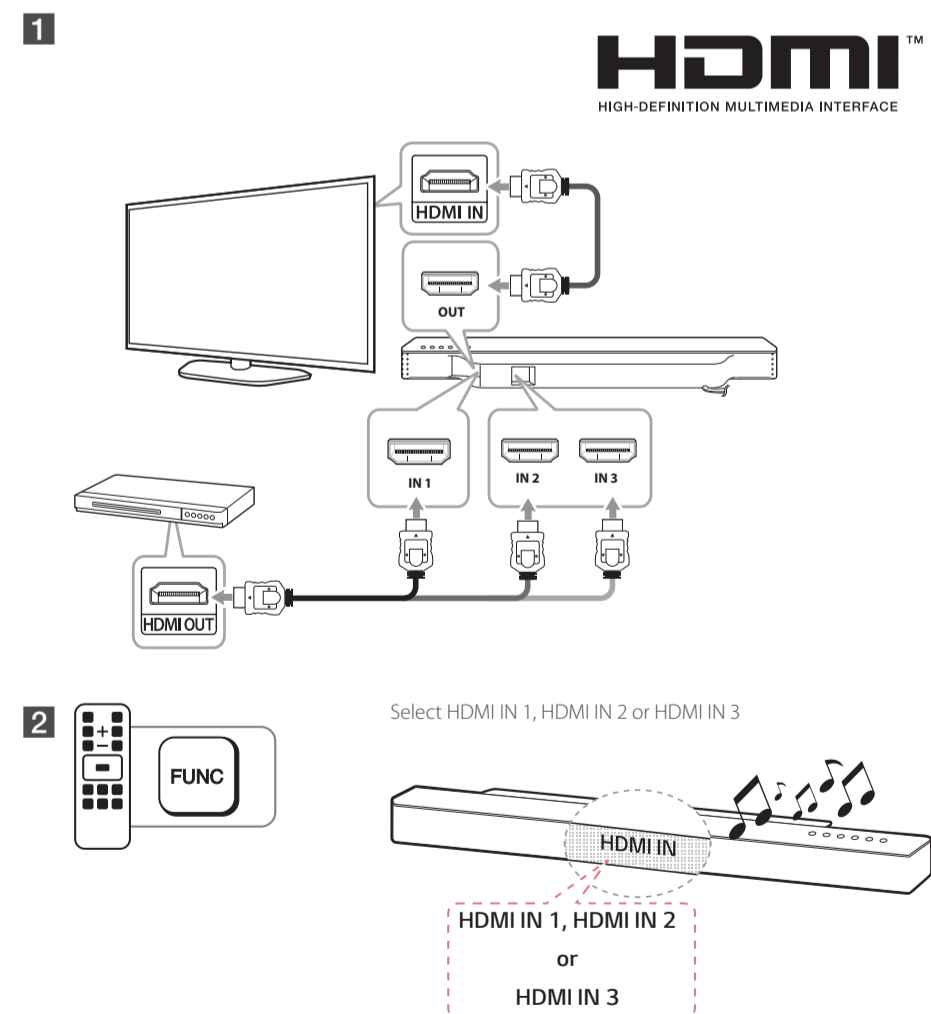

HDMI ARC (Audio Return Channel) operation

The ARC function enables an HDMI capable TV to send the audio stream to HDMI OUT of the unit.

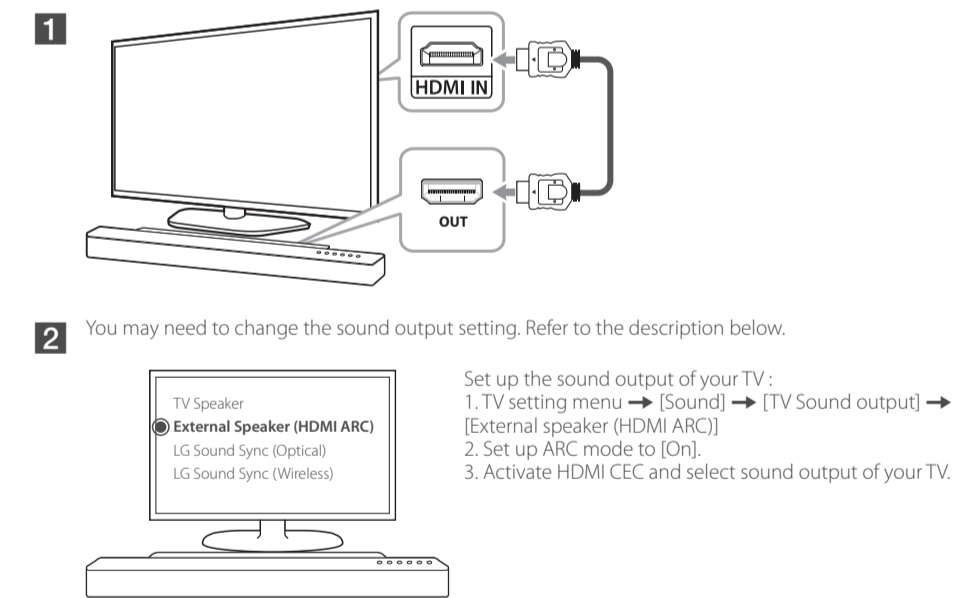

Sound Sync

Wireless

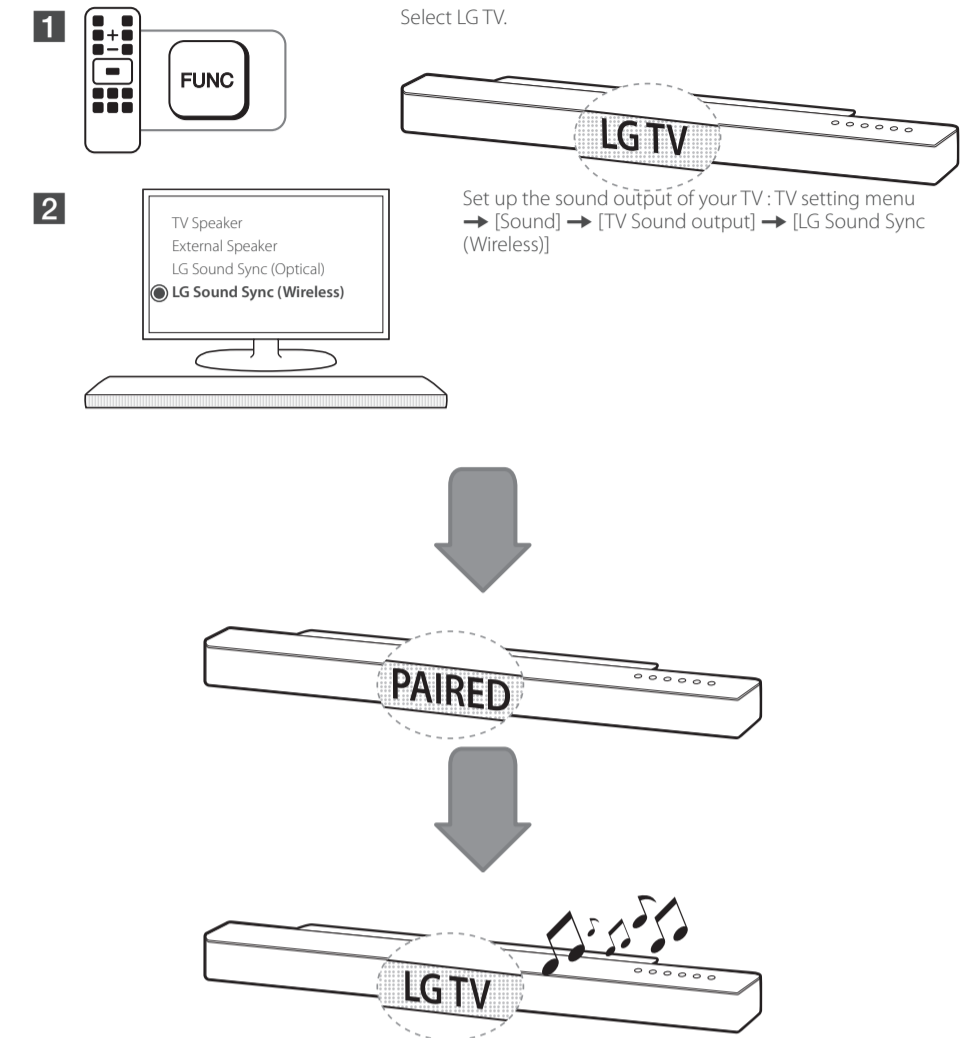

ARC function is automatically selected when you turn on your TV no matter what kind of the function you are using.

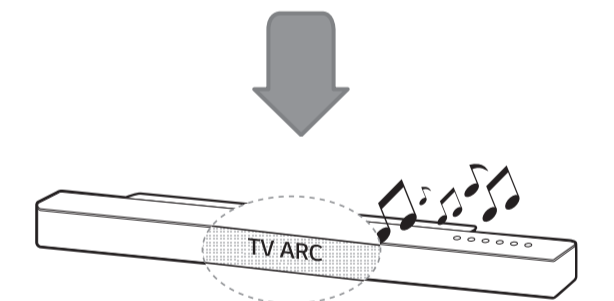

SIMPLINK





SIMPLINK enables you to control some functions of this unit by a remote control of your TV. Controllable functions are power on/off and volume up/down, etc. Make sure that your TV has the SIMPLINK logo as shown above.

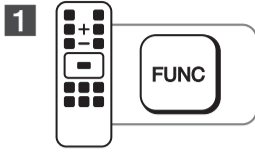

## Using Bluetooth

- 

Select Bluetooth function.

- 

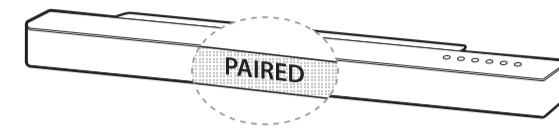
LG H59 (XX:XX)



- 

Enter the PIN code (0000) as needed.

Play music on your Bluetooth device.

- Sound quality may become lower or disconnected depending on the distance, interference or obstacles.
- Depending on the type of the device, you may not be able to use the Bluetooth function.

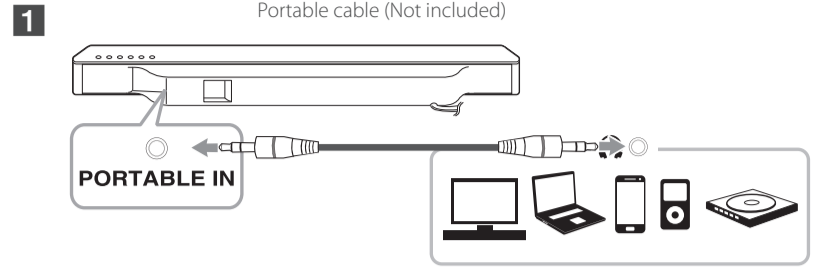
## Using External device

- 

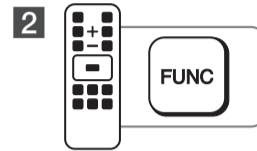
Portable cable (Not included)
- 

Select PORTABLE.

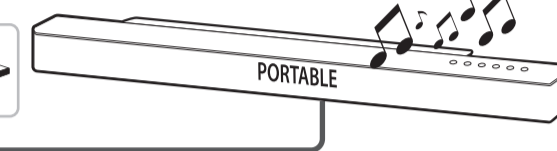

- 

Play the music on the connected external device.

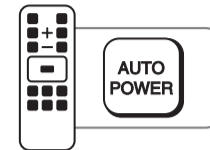

## Auto power On/Off

This unit automatically turns on and off by an input source : Optical.



Turns on or off AUTO POWER function.

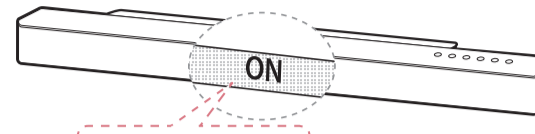

ON - AUTO POWER  
↑ ↓  
OFF - AUTO POWER

- Depending on the connected device, this function may not operate.
- If you turned off the unit directly, it cannot be turned on automatically by AUTO POWER function. However the unit can be turned on by AUTO POWER function when optical signal comes in after 5 seconds of no signal.
- After the unit is turned on by AUTO POWER function, it will be automatically turned off if there is no signal for a certain period of time from the external device connected by an optical cable.

## Using your TV remote control

You can control some functions of this unit by your TV remote control even in other company's product. Controllable functions are volume up/down and mute.

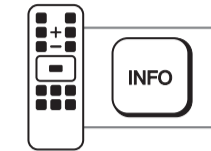

Press and hold to turn on or off this function.

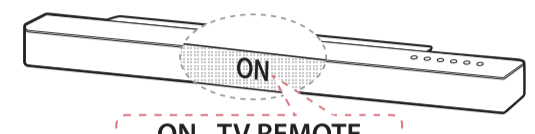

ON - TV REMOTE  
↑ ↓  
OFF - TV REMOTE

Supported TV brands

LG	Panasonic	Philips	Samsung	Sharp	Sony	Toshiba	Vizio
----	-----------	---------	---------	-------	------	---------	-------

- Make sure that the sound output of your TV is set to [External speaker].
- Depending on the remote control, this function may not work well.

## Remote Control

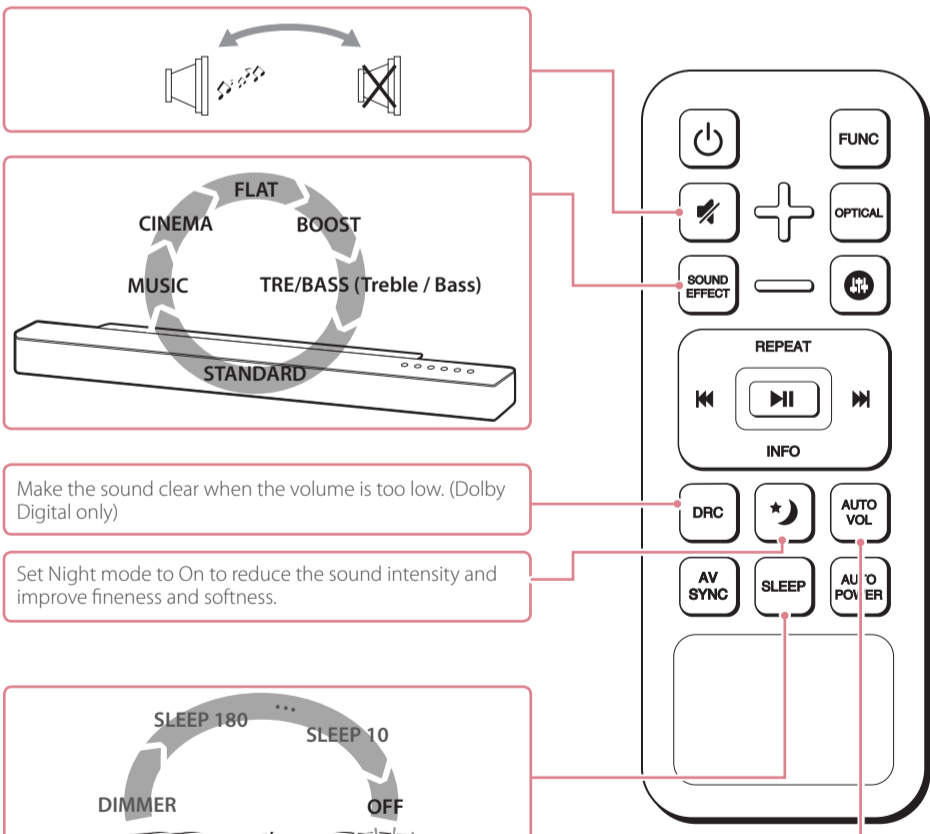



- OPTICAL function is selected directly. If you press this button again, the function is returned to previous one.
- Adjusts sound level of Treble, Bass and Sub-woofer.
- Controls playback on Wi-Fi mode.
- Press once.
- Synchronizes the audio and video. (0 to 300 ms)

Make the sound clear when the volume is too low. (Dolby Digital only)

Set Night mode to On to reduce the sound intensity and improve fineness and softness.

Adjusts the volume level appropriately.

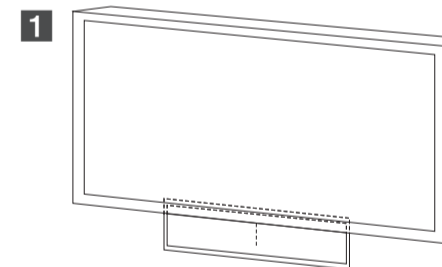
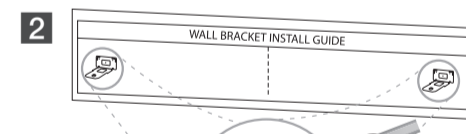
## Installation

- 
- 
- 

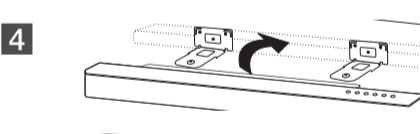
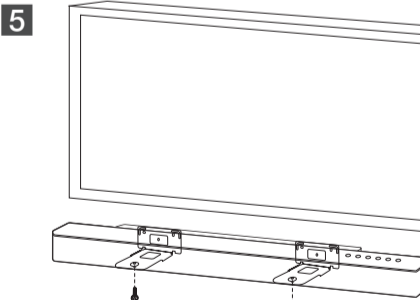
Screws and wall plugs are not supplied.
- 
- 

- Because it is difficult to make a connection after installing this unit, you should connect the cables before installation.
- Do not install this unit on Metallic furniture.
- Screws and Wall Plugs are not supplied for mounting the unit. We recommend the Hilti (HUD-1 6 x 30) for the mounting.

## Installing cover foot

You can extend the height of the unit by using cover foot (height : 11 mm)

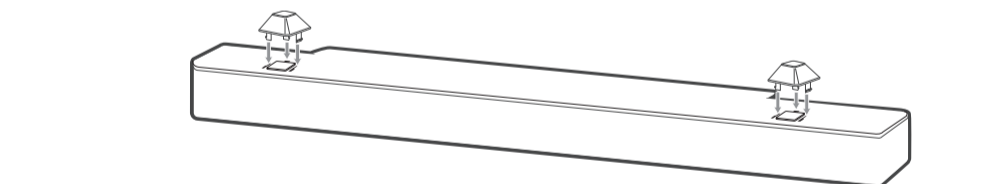

## IR Blaster operation

If this unit covers TV Remote sensor, you can connect and use IR Blaster as show in illustration.

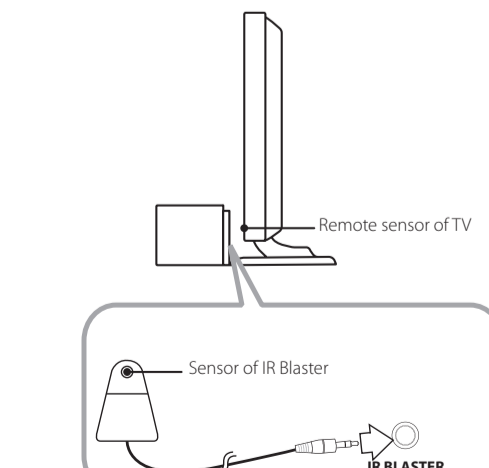

Remote sensor of TV

Sensor of IR Blaster

IR BLASTER



**MUSICflow** HS9  
SMART Hi-Fi AUDIO  
Wireless Multi-room Sound Bar

Model: LAS950M

ENGLISH | SIMPLE MANUAL (2 of 2)

To view the instructions of advanced features, visit <http://www.lg.com> and then download Owner's Manual. Some of the content in this manual may differ from your unit.

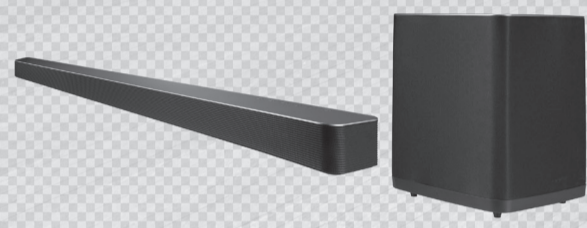

[www.lg.com](http://www.lg.com)

**Step 1 Before using "Music Flow Player" App**

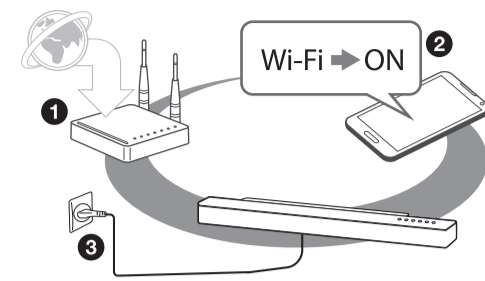

- 1 Be sure to have a wireless network using a broadband router installed in your home.
- 2 Connect your smart device to your home network.
- 3 Plug the power cord into the mains.

- ! The wireless router should be connected to the internet.
- ! Wireless signal interference may lead to disruption of network stability and playback.
- ! Depending on the speed of your network, playback of music services may not work well.
- ! You can switch the display to ON or OFF in [Settings] → [Speakers] → [Speaker LED] on App.

**Step 2 Installing "Music Flow Player" App**

Download "Music Flow Player" on the iTunes store or Google Play Store.



A Type "Music Flow Player" in the search bar and tap "Search".

B Scan the QR code using a scanning application.

! Depending on the device, "Music Flow Player" app may not work.

! Music Flow Player app will be available with versions of the software as follow;  
Android O/S : Ver 2.3.3 (or later) iOS O/S : Ver 5.1.1 (or later)

**Step 3 Network Connection (Option 1 : Wired)**

Using Music Flow Player app, select [Wired connection] and follow the on-screen instructions.

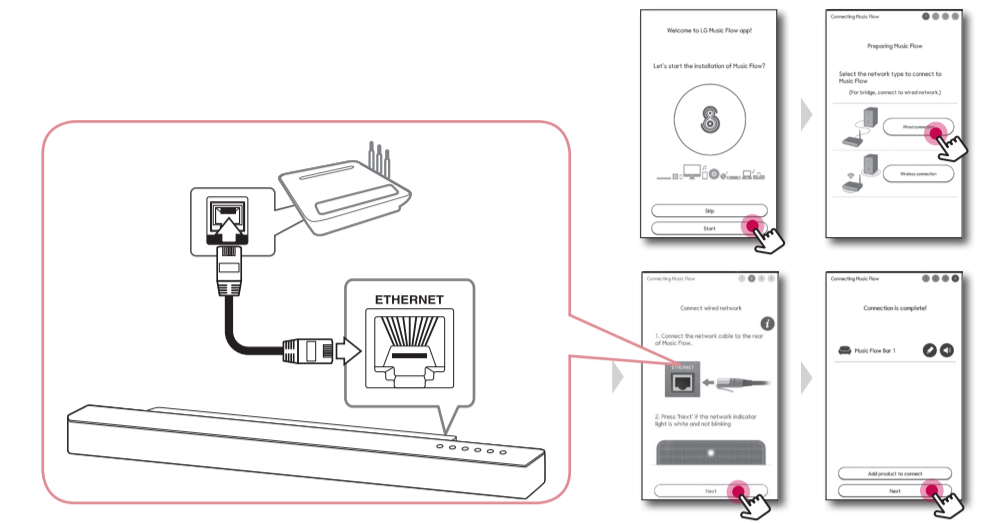

! If you restart the router, you will also need to reset the power of the speaker.

! If you install a new router, you will need to setup the network connection for the speaker.

**Step 3 Network Connection (Option 2 : Wireless\_Android)**

Using Music Flow Player app, select [Wireless connection] and follow the on-screen instructions.

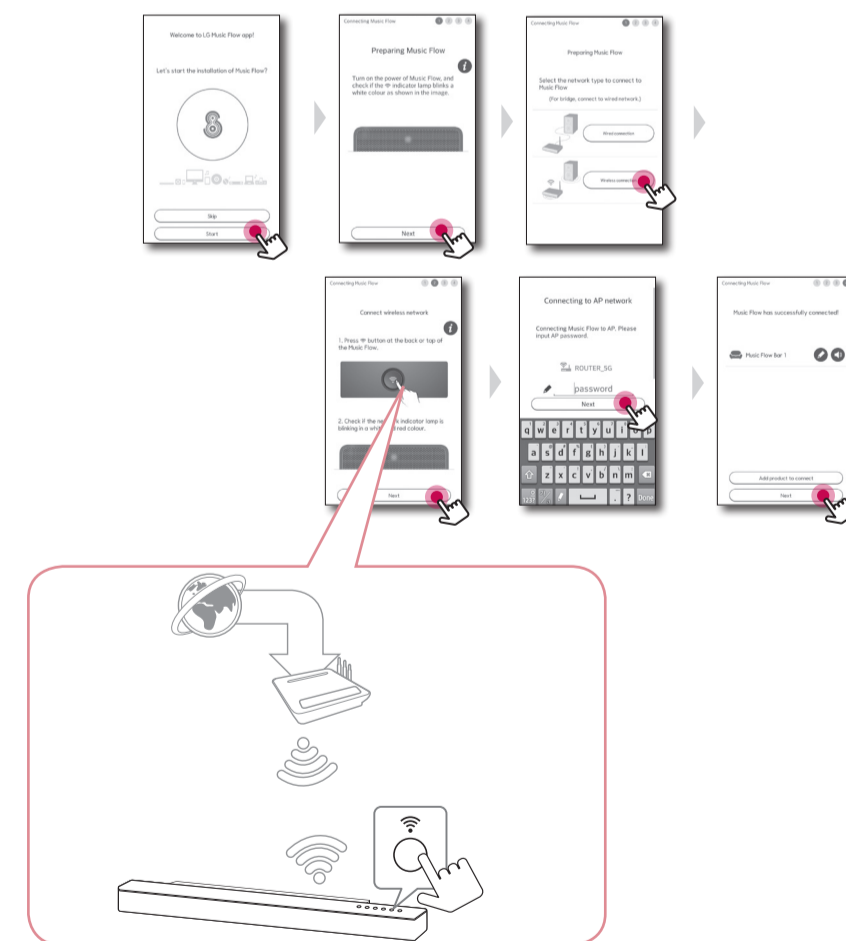

**Step 3 Network Connection (Option 2 : Wireless\_iSO)**

Using Music Flow Player app, select [Wireless connection] and follow the on-screen instructions.

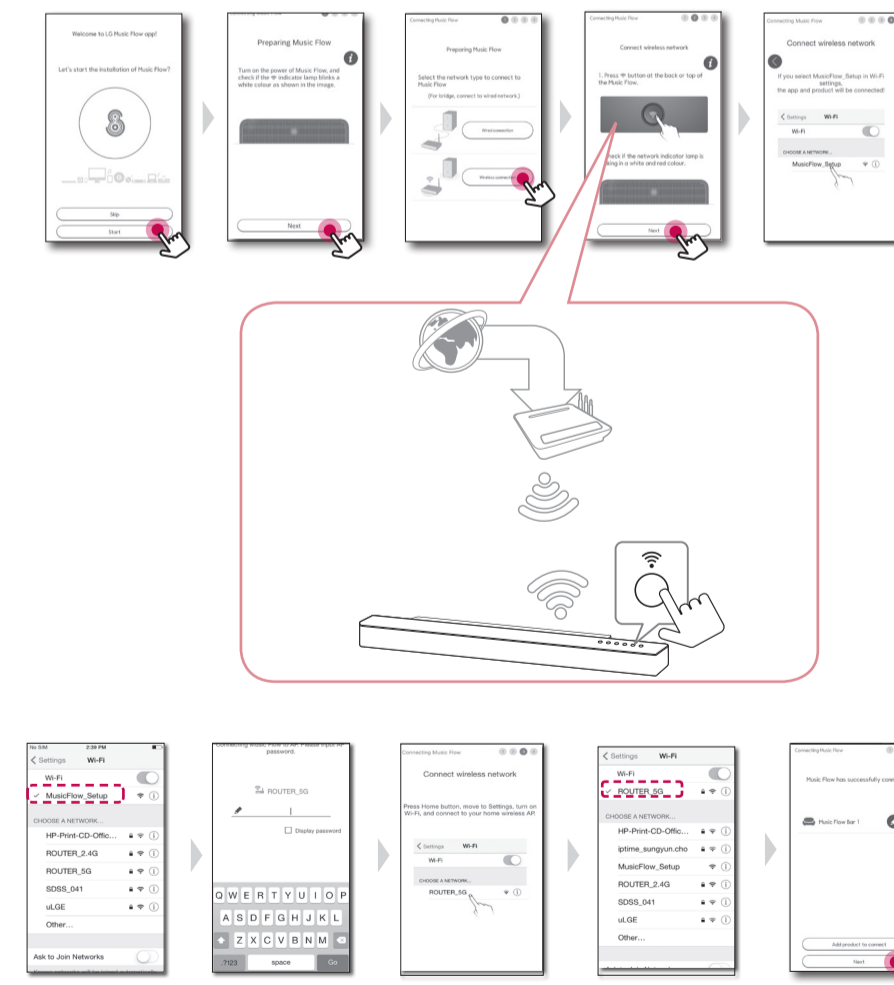

**Step 4 Music Playback**

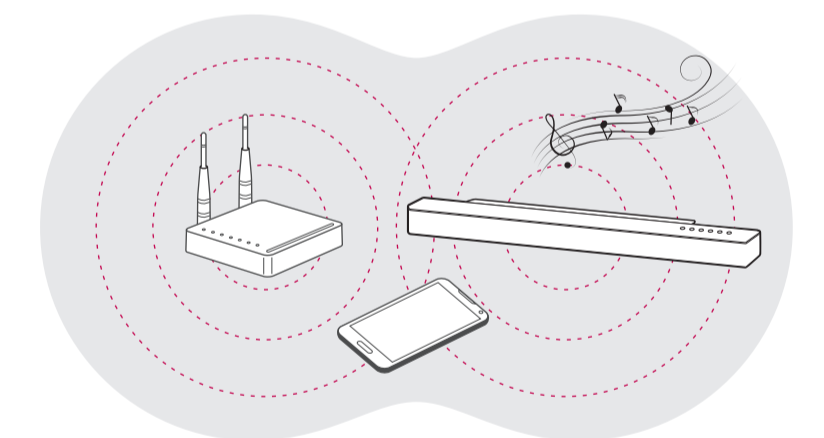

Playing a song on this device

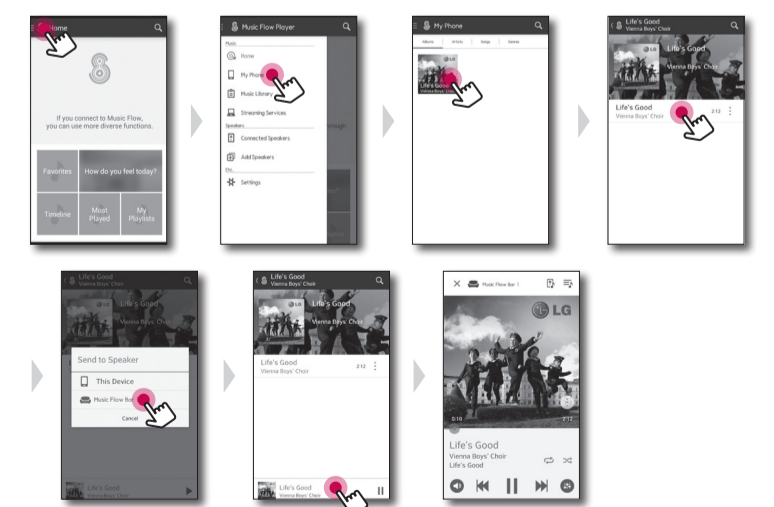

## Multiple sound playback

There are a number of differing ways of listening to sound : Grouping and Surround playbacks. To use this playbacks, you should have several LG SMART HI-FI AUDIO.

Before using the playbacks, you should add another LG SMART HI-FI AUDIO.

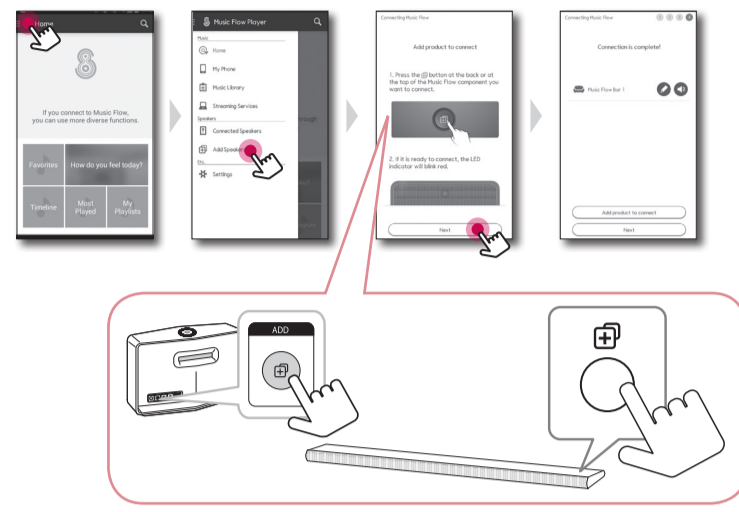

## Grouping

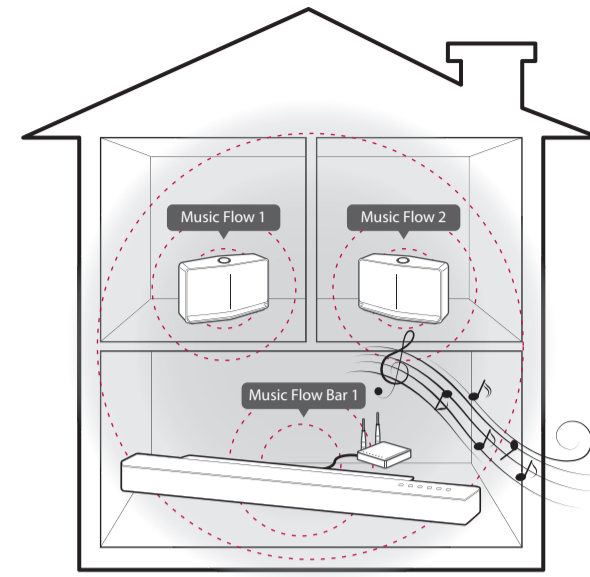

Any number of speakers can be grouped together to play the same music in synchrony. On Music Flow Player app, select [Connected Speakers] and follow the directions on screen.

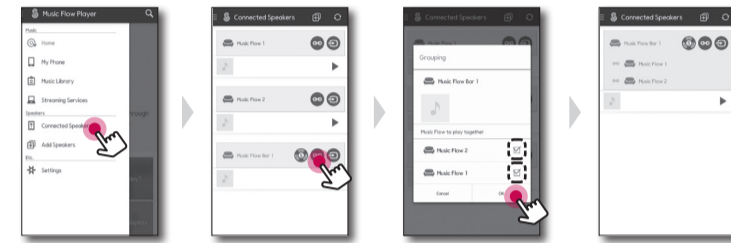

## Surround

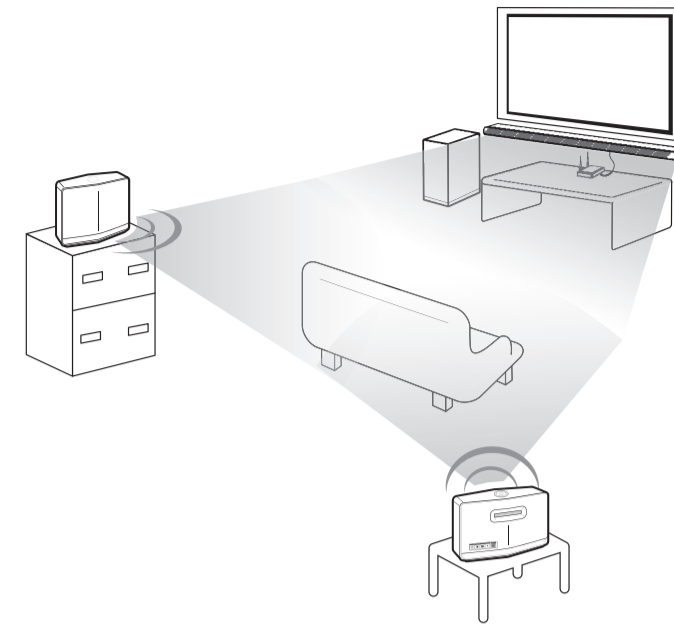

You can enjoy surround sound by adding another two speakers. On Music Flow Player app, select [Connected Speakers] and follow the directions on screen.

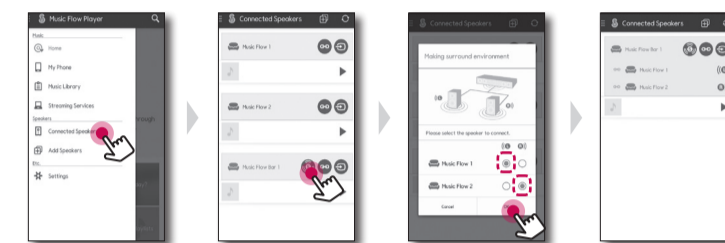

## Reset this Sound Bar System

### Initializing the network settings

Press and hold the  button until you hear the beep sound once. Then all wireless network ports are deactivated and delete the stored wireless network information.

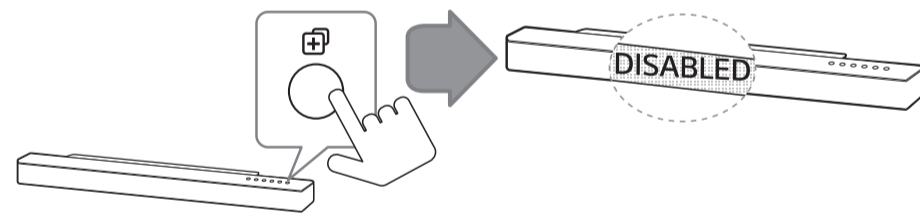

### Factory Set

Press and hold the  button until you hear the beep sound twice.

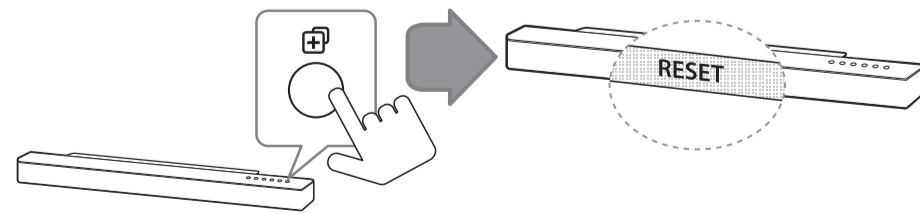

## Specification

### ENGLISH

Power requirements	110 - 240 V ~ 50 / 60 Hz
Power consumption	50 W Networked standby : 6.0 W (If all network ports are activated.)
Amplifier Total output	700 W
Bluetooth	Version 4.0 Codec SBC
Dimensions (W x H x D)	(1100 x 106 x 135) mm (without Foot)
Net Weight (Approx.)	8.2 kg

Design and specifications are subject to change without notice.

### OPEN SOURCE SOFTWARE NOTICE

To obtain the source code under GPL, LGPL, MPL and other open source licenses, that is contained in this product, please visit <http://opensource.lge.com>. In addition to the source code, all referred license terms, warranty disclaimers and copyright notices are available for download.

LG Electronics will also provide open source code to you on CD-ROM for a charge covering the cost of performing such distribution (such as the cost of media, shipping and handling) upon email request to [opensource@lge.com](mailto:opensource@lge.com). This offer is valid for three (3) years from the date on which you purchased the product.

## Safety Information

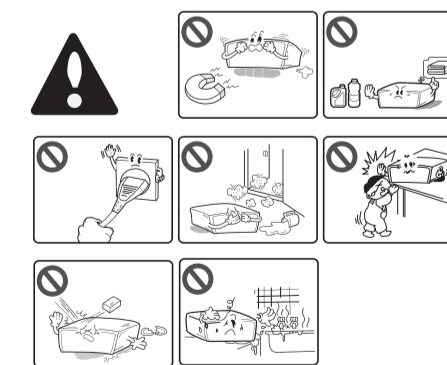

**CAUTION:** TO REDUCE THE RISK OF ELECTRIC SHOCK DO NOT REMOVE COVER (OR BACK) NO USER-SERVICEABLE PARTS INSIDE REFER SERVICING TO QUALIFIED SERVICE PERSONNEL.

This lightning flash with arrowhead symbol within an equilateral triangle is intended to alert the user to the presence of uninsulated dangerous voltage within the product's enclosure that may be of sufficient magnitude to constitute a risk of electric shock to persons.

The exclamation point within an equilateral triangle is intended to alert the user to the presence of important operating and maintenance (servicing) instructions in the literature accompanying the product.

**WARNING:** TO PREVENT FIRE OR ELECTRIC SHOCK HAZARD, DO NOT EXPOSE THIS PRODUCT TO RAIN OR MOISTURE.

**WARNING:** Do not install this equipment in a confined space such as a book case or similar unit.

**CAUTION:** The apparatus shall not be exposed to water (dripping or splashing) and no objects filled with liquids, such as vases, shall be placed on the apparatus.

**CAUTION:** Do not block any ventilation openings. Install in accordance with the manufacturer's instructions. Slots and openings in the cabinet are provided for ventilation and to ensure reliable operation of the product and to protect it from over heating. The openings shall be never be blocked by placing the product on a bed, sofa, rug or other similar surface. This product shall not be placed in a built-in installation such as a bookcase or rack unless proper ventilation is provided or the manufacturer's instruction has been adhered to.

### CAUTION concerning the Power Cord

The Power Plug is the disconnecting device.

In case of an emergency, the Power Plug must remain readily accessible.

This device is equipped with a portable battery or accumulator.

**Safety way to remove the battery or the battery from the equipment:** Remove the old battery or battery pack, follow the steps in reverse order than the assembly. To prevent contamination of the environment and bring on possible threat to human and animal health, the old battery or the battery put it in the appropriate container at designated collection points. Do not dispose of batteries or battery together with other waste. It is recommended that you use local, free reimbursement systems batteries and accumulators. The battery shall not be exposed to excessive heat such as sunshine, fire or the like.

**CAUTION:** Only use the AC adapter supplied with this device. Do not use a power supply from another device or another manufacturer. Using any other power cable or power supply may cause damage to the device and void your warranty.

**NOTICE:** For safety marking information including product identification and supply ratings, please refer to the main label on the bottom or rear of the apparatus.