

Additional Information

Specification

Power requirements	Refer to main label.
Power consumption	Refer to main label. Networked standby : 0.4 W (If all network ports are activated.)
Dimensions (W x H x D)	Approx. 360 mm x 60.5 mm x 299 mm
Net Weight	Approx. 2.69 kg
Bus Power Supply (USB)	5 V  500 mA
Amplifier (Total RMS output power)	1,000 W

Design and specifications are subject to change without notice.

How to disconnect the wireless network connection or the wireless device

Turn off the unit by pressing the power button for more than 5 seconds.

Replacement of battery

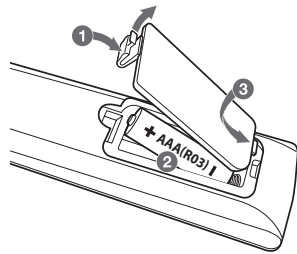

POWER: This unit operates on a mains supply of 200 - 240 V ~, 50 / 60 Hz.

Wiring: This unit is supplied with a BS 1363 approved main plug. When replacing the fuse, always use of the same rating approved to BS 1362. Never use this plug with the fuse cover omitted. To obtain a replacement fuse cover contact your dealer. If the type of plug supplied is not suitable for the mains sockets in your home, then the plug should be removed and a suitable type fitted. Please refer to the wiring instructions below.

Warning: A mains plug removed from the mains lead of this unit must be destroyed. A mains plug with bared wires is hazardous if inserted in a mains socket. Do not connect either wire to the earth pin, marked with the letter E or with the earth symbol  or coloured green or green and yellow. If any other plug is fitted, use same rating of fuse in the plug.

Important: The wires in this mains lead are coloured in accordance with the following codes:

- BLUE: NEUTRAL, BROWN: LIVE: As the colours of the wires in the mains lead of this unit may not correspond with the coloured marking identifying the terminals in your plug, proceed as follows: The wire which is coloured blue must be connected to the terminal which is marked with the letter N or coloured black. The wire which is coloured brown must be connected to the terminal which is marked with the letter L or coloured red.



To view the instructions of advanced features, visit <http://www.lg.com> and then download Owner's Manual. Some of the content in this manual may differ from your unit.

MODEL
LHD655





Front Panel

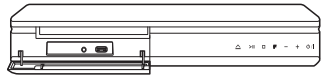

- PORT. IN: Connect to a Portable device.
- USB Port: Connect a USB device.
- △: Disc Tray Open / Close
- ▶||: Starts / Pauses playback.
- : Stops playback.
- F: Changes the input source or function.
- / +: Adjusts volume.
- ⏻ / I: Power On / Off

Rear Panel

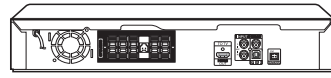

- SPEAKERS: Connect to speakers.
- HDMI OUT TO TV: Connect to TV.
- AUX (L/R) INPUT: Connect to analogue device.
- VIDEO OUT: Connect to TV.
- OPTICAL IN: Connect to digital device.
- ANTENNA FM: Connect to radio antenna.

1 Speaker Assembling

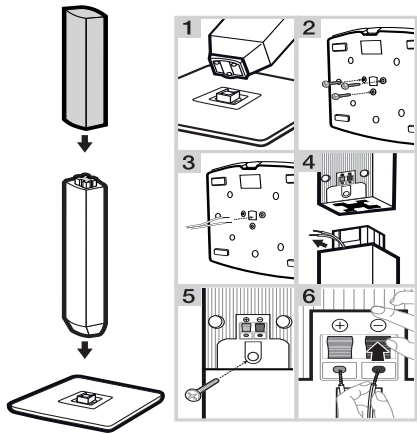

2 Speaker Connection

! Speaker design and connection method may be different according to models.

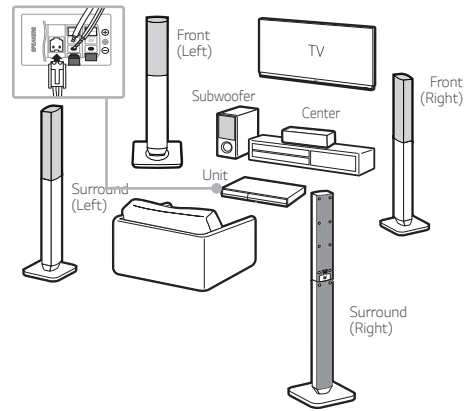

3 TV Connection

HDMI & Optical Connection

- 1 Connect the Player to the TV using HDMI & Optical cable.
- 2 Set the input selector to HDMI on the TV.
- 3 Set up [External Speaker (Optical)] on your TV setting menu.
- 4 Follow the instructions on the TV screen using remote control.

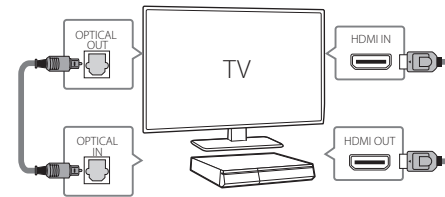

4 Home Menu

Home menu appears on the TV screen. Enjoy various functions on the player.



LG Sound Sync (Wireless)



For more information, download the online owner's manual. <http://www.lg.com>