

⊕ : Depending on model / حسب الطراز / В зависимости от модели / Závisí na modelu / Selon le modèle / Abhängig vom Modell / Ανάλογα με το μοντέλο /
Típusfüggő / In base al modello / Zależnie od modelu / Dependendo do modelo / În funcție de model / В зависимости от модели / U zavisnosti od mod-
ela / Ovisno o modelu / Odvisno od modela / En función del modelo / Modele bağı olarak değişkenlik gösterebilir / Залежно від моделі / Rusumga qarab





English

- Read **Safety and Reference**.
- For the power supply and power consumption, refer to the label attached to the product.

Български

- Прочетете **Безопасност и справки**.
- Направете справка с етикета на продукта за електрозахранването и консумацията на енергия.

Français

- Lire le document **Sécurité et référence**.
- Reportez-vous à l'étiquette apposée sur le téléviseur pour connaître l'alimentation et la consommation électriques.

Ελληνικά

- Ανάγνωση **Ασφάλεια και αναφορά**.
- Για πληροφορίες σχετικά με την τροφοδοσία και την κατανάλωση ενέργειας, δείτε την ετικέτα του προϊόντος.

Italiano

- Consultare la sezione **Sicurezza e informazioni di riferimento**.
- Per l'alimentazione e il consumo di energia, consultare l'etichetta applicata sul prodotto.

Português

- Consulte o manual de **Segurança e Referência**.
- No que respeita à fonte de alimentação e ao consumo de energia, consulte a etiqueta mostrada no produto.

Русский

- Прочтите **Руководство по технике безопасности**.
- Требования параметров электропитания и значения потребляемой мощности указаны на информационном лейбле на задней крышке изделия.

Hrvatski

- Pročitajte **Sigurnost i reference**.
- Informacije o napajanju i potrošnji energije potražite na oznaci koja se nalazi na proizvodu.

Español

- Leer **Seguridad y Referencias**.
- Para obtener información acerca de la fuente de alimentación y el consumo de energía, consulte la etiqueta del producto.

Українська

- Прочитайте **Правила безпеки та довідкова інформація**.
- Відомості щодо подачі живлення і споживання електроенергії дивіться на наліпці на виробі.

العربية

- قراءة السلامة والمرجع.
- لمعرفة المزيد حول مصدر الإمداد بالطاقة ومعايير استهلاك الطاقة، راجع الملصق الموجود على المنتج.

Česky

- Přečtěte si část **Bezpečnost a reference**.
- Informace o napájení a příkonu naleznete na štítku připevněném k výrobku.

Deutsch

- **Sicherheitshinweise und Referenzen:** Bitte lesen!
- Informationen zur Stromversorgung und zum Stromverbrauch sind dem Etikett auf dem Gerät zu entnehmen.

Magyar

- Lásd: **Biztonsági óvintézkedések**.
- A tápellátásra és az áramfogyasztásra vonatkozó adatok a készülékre ragasztott címkén találhatóak.

Polski

- Przeczytaj **Zasady bezpieczeństwa i informacje dodatkowe**.
- Dokładne informacje o zasilaniu i zużyciu energii są umieszczone na etykiecie znajdującej się na produkcie.

Română

- Citiți **Siguranță și referințe**.
- Pentru sursa de alimentare și consumul de energie, consultați eticheta atașată pe produs.

Srpski

- Pročitajte **Bezbednost i informacije**.
- Da biste saznali informacije u vezi sa napajanjem i potrošnjom energije, pogledajte oznaku na proizvodu.

Slovenščina

- Preberite **Varnostne informacije in napotki**.
- Podatke o napajanju in porabi energije si oglejte na nalepki izdelka.

Türkçe

- **Güvenlik ve Referans** bölümünü okuyun.
- Güç kaynağı ve güç tüketimi için ürüne yapıştirilmiş olan etikete bakın.

O'zbekcha

- Xavfsizlik bo'yicha ko'rsatmalar va havolalar o'qib chiqing.
- Quvvat ta'minoti va quvvat iste'moli uchun mahsulotga yopishtirilgan yorliqqa qarang.

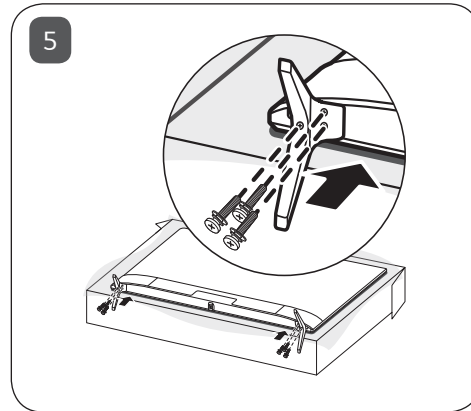
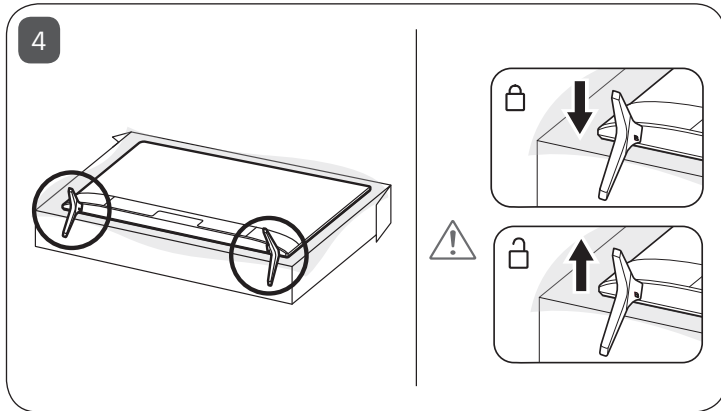
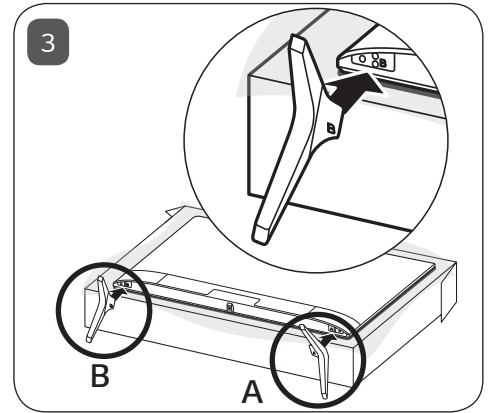
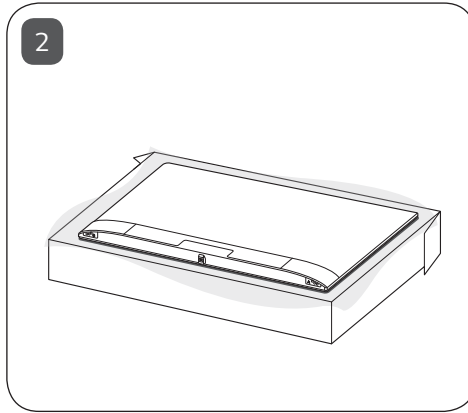
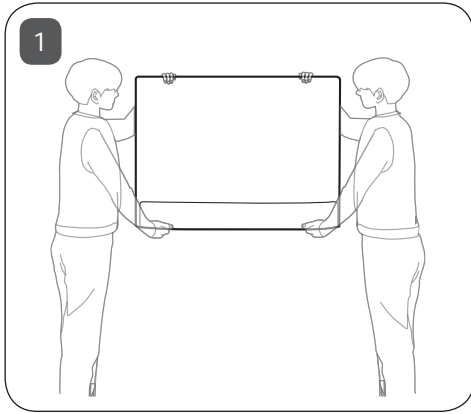

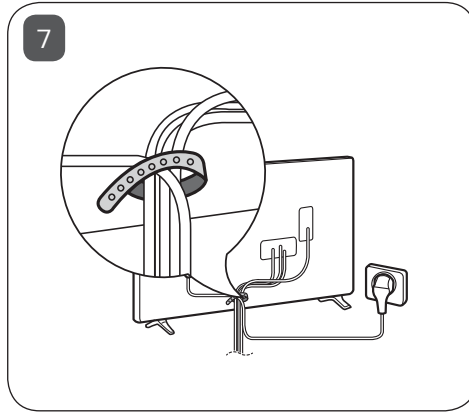
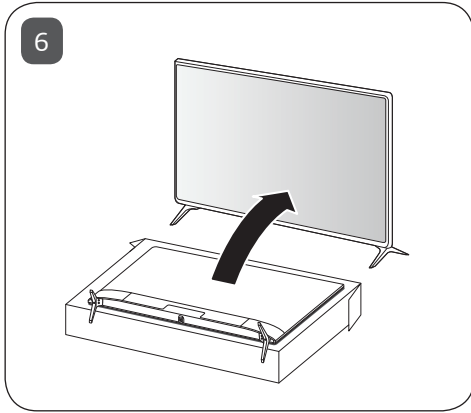

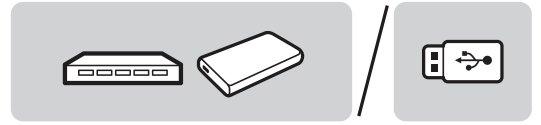
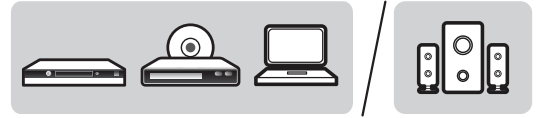
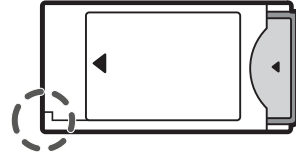
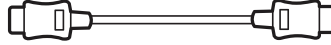
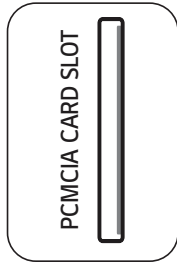
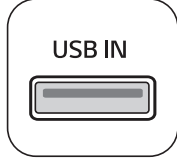
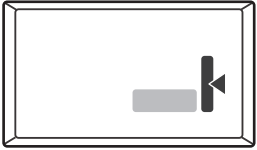

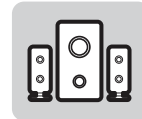
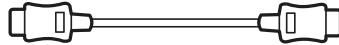
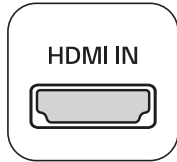
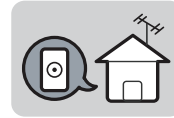
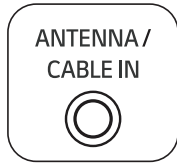
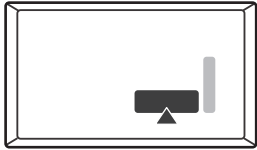

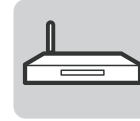
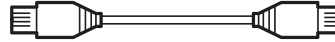
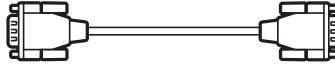
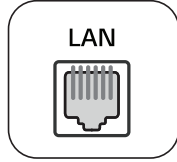
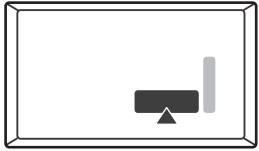

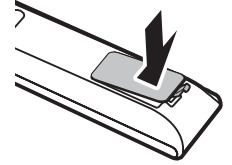
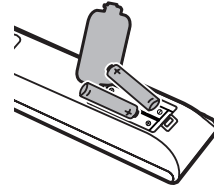
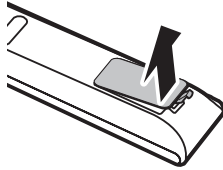
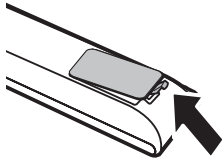
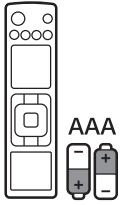

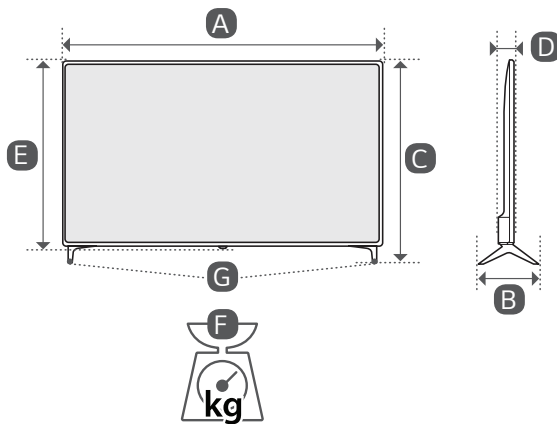

	A	B	C	D	E	F	F-G
	(mm)					(kg)	
75UT640S0ZA	1693	345	1048	88.8	978	35.4	34.6
Power requirement					AC 100-240 V - 50 / 60 Hz		



FOYDALANISH BO'YICHA QO'LLANMA

Xavfsizlik bo'yicha ko'rsatmalar va havolalar

LED TV*

* LG LED TVda LED yoritgichlariga ega bo'lgan LCD ekrandan foydalaniladi.

Iltimos, televizoringizdan foydalanishdan avval ushbu qo'llanmani diqqat bilan o'qib chiqing va undan keyinchalik foydalanish uchun saqlab qo'ying.

Ogohlantirish! Xavfsizlik texnikasi ko'rsatmalari



DIQQAT: ELEKTR ZARBASINING OLDINI OLISH UCHUN QOPQOQNI (YOKI ORQA QISMINI) OCHMANG. ICHIDA FOYDALANUVCHI TA'MIRLAY OLADIGAN QISMLAR YO'Q. MALAKALI MUTAXASSISGA MUHOJAAT QILING.

 Ushbu belgi mahsulot ichida odamlarni elektr zarbasi urishi mumkin bo'lgan "xavfli kuchlanishga" ega izolyatsiyalanmagan qism borligini bildiradi.

 Ushbu belgi moslama bilan birga kelgan qo'llanma ichida muhim qo'llash va ta'mirlash (xizmat ko'rsatish) ko'rsatmalar borligi haqida foydalanuvchini ogohlantiradi.

OGOHLANTIRISH: YONG'IN YOKI ELEKTR ZARBASINING OLDINI OLISH UCHUN MAHSULOTNI YOMG'IR OSTIDA YOKI NAM JOYGA O'RNMATMANG.

• YONG'IN TARQALISHINING OLDINI OLISH UCHUN SHAM YOKI BOSHQA OCHIQ OLOVGA EGA NARSALARNI DOIMO MAHSULOTDAN UZOQDA TUTING.

• **Televizor va/yoki masofadan boshqarish pultini quyidagi joylarda qoldirmang:**

- Mahsulotni to'g'ridan-to'g'ri quyosh nurlarining ta'siridan saqlang.
- Namlik yuqori bo'lgan joylar, masalan, hammomda.
- Issiqlik manbalari, masalan, pechlar va boshqa issiqlik hosil qiluvchi qurilmalar yaqinida.
- Oshxona peshtaxtalari yoki namlantirgichlar yaqinida; bu yerda ular osongina bug' yoki moy ta'sirida qolishlari mumkin.
- Yomg'ir yoki shamol mavjud joylarda.
- Mahsulotni suv tomchilashi yoki sachrashi ta'siriga qo'ymang va vaza, kosa kabi suv to'ldirilgan buyumlarni mahsulot ustiga yoki uning yuqorisida (masalan, qurilma ustidagi tokchalarga) qo'ymang.
- Benzin yoki shamchiroq kabi tez alanga oladigan narsalar yoniga, yoki TVga havo konditsioneri to'g'ridan-to'g'ri uradigan qilib o'rnatish.
- O'ta chang joylarga o'rnatmang.

Aks holda bu yomg'in, elektr toki urishi, yomg'in/portlash, noto'g'ri ishlash yoki mahsulot deformatsiyasiga olib kelishi mumkin.

• **Havo aylanish tizimi**

- TVni yaxshi havo aylanish tizimi mavjud bo'lgan joyga o'rnatmang. Kitoblar javoni kabi yopiq joyga o'rnatmang.
- Mahsulotni gilam yoki divan yostig'iga o'rnatmang.
- Mahsulot elektr manbaiga ulangan vaqtda uni sochiq yoki boshqa materiallar bilan to'smang yoki yopmang.
- Havo aylanish tizimi darchalariga tegmayotganiga ishonch hosil qiling. TVni uzoq vaqt davomida tomosha qilganda, uning havo aylanish darchalari qizib ketishi mumkin.
- Quvvat manbaiga ulash shnurini bukish, ezish, eshikka qisib qo'yish yoki ustidan yurish kabi jismoniy yoki mexanik ta'sirlardan himoya qiling. Vilkalar, rozetkalar va shnur qurilmadan chiqadigan joylarga alohida e'tibor bering.
- Elektr shnuri quvvat manbaiga ulangan vaqtda TVni qimirlatmang.
- Shikastlangan yoki amallab yetadigan elektr shnuridan foydalanmang.
- Elektr shnurini quvvat manbaidan chiqarib olayotganda vilkani mahkam ushlaganingizga ishonch hosil qiling. TVni quvvat manbaidan uzish uchun elektr shnuridan tortmang.
- Tarmoq rozetkasiga juda ko'p qurilmalarni ulamang, chunki bu uning yonishiga yoki tok urishiga sabab bo'lishi mumkin.
- **Qurilmani Asosiy quvvat manbaidan uzish**
 - Elektr shnur vilkasi qurilmani uzish vositasi hisoblanadi. Favqulodda vaziyatlarda elektr shnur vilkasiga to'siqsiz yetish mumkin bo'lishi lozim.
- Farzandlaringizni televizorga osilib yoki tirmashib chiqishlariga yo'l qo'ymang. Aks holda, televizor ag'darilishi va jiddiy jarohat yetkazishi mumkin.
- **Tashqaridagi antennani yerga ulash** (Mamlakatga qarab farq qilishi mumkin):
 - Tashqaridagi antenna o'rnatilgan bo'lsa, quyidagi ehtiyot choralariga rioya qiling. Tashqaridagi antenna tizimi elektr simlari yoki elektr chiroqlari yoki elektr tarmoqlariga yaqin, shuningdek, ular bunday elektr simlari yoki elektr tarmoqlari bilan tutashishi mumkin bo'lgan joylarga joylashtirilmasligi lozim, chunki bunday holatlar o'lim yoki jiddiy shikast yetishiga sabab bo'lishi mumkin. Kuchlanishning keskin oshishi va statik zaryad ortirishining oldini olish uchun antenna tizimi yerga tutashtirilganligiga ishonch hosil qiling. AQSh Elektr jihozlaridan foydalanish Milliy kodeksining 810-bo'limi antenna machtasi va tayanch konstruksiyasining yerga ulanishi, o'tkazgichning antenna razrayad blokiga ulanishi, yerga ulanish o'tkazgichlari o'lchami, antenna razrayad bloki joylashuvi, yerga ulaydigan elektrodlar ulanishi va yerga ulaydigan elektrodlarga qo'yilgan talablar to'g'riligi bo'yicha ma'lumotlarni taqdim etadi. Elektr jihozlardan foydalanish Milliy kodeks bo'yicha antennani yerga ulash, ANSI/NFPA 70

- **Yerga ulash** (Yerga ulanmaydigan qurilmalar bundan istisno.)
 - Uchta tishli o'zgaruvchan tok shtekeri bilan yerga ulangan TV o'zgaruvchan tokning uchta teshikli yerga ulash rozetkasiga ulanishi lozim. Tok urishining oldini olish uchun yerga ulash kabeli to'g'ri ulanganligiga ishonch hosil qiling.
- Chaqmoq va momaqaldiroq vaqtida bu apparat yoki antennaga tegmang. Sizni elektr toki urishi mumkin.
- Elektr kabel TV va devordagi rozetkaga xavfsiz tarzda ulanganligiga ishonch hosil qiling, agar xavfsizlik ta'minlanmagan bo'lsa, teshik va vilkaga zarar yetishi va ekstremal holatlarda yong'in yuzaga kelishi mumkin.
- Metall yoki tez yonuvchan obyektlarni mahsulot ichiga tiqmang. Agar mahsulot ichiga yod jism tushib ketisa, elektr shnurini chiqarib oling va mijozlarga xizmat ko'rsatish markazi bilan bog'laning.
- Elektr shnurining bir uchi quvvat manbaiga ulangan vaqtda uning boshqa uchiga tegmang. Sizni elektr toki urishi mumkin.
- **Quyidagilardan birortasi yuzaga kelsa, mahsulotni quvvat manbaidan darhol uzing va mahalliy mijozlarga xizmat ko'rsatish markazi bilan bog'laning.**
 - Mahsulotga zarar yetganda.
 - Agar mahsulot (tarmoq adapteri, elektr shnuri yoki TV kabi) ichiga suv yoki boshqa mayda zarra kirib ketisa.
 - Agar TVdan tutun hidini yoki boshqa noxush hidlar chiqayotganini sezsangiz.
 - Chaqmoq va momaqaldiroq vaqtida yoki uzoq muddat davomida ishlatilmaganda.

TV pult yoki quvvat tugmasi orqali o'chirilgan bo'lsa ham, agar elektr shnur uzilmasa, o'zgaruvchan tik manbai blokka ulangan bo'ladi.
- TV yonida yuqori kuchlanishda ishlaydigan elektr jihozlardan (masalan, elektron pashsha haydagich) foydalanmang. Bu mahsulotning noto'g'ri ishlashiga olib kelishi mumkin.
- LG Electronics kompaniyasining yozma ruxsatisiz bu mahsulotni har qanday usul bilan o'zgartirishga urinmang. Yong'in chiqishi yoki toki urishi mumkin. Yordam yoki ta'mirlash uchun mahalliy mijozlarga xizmat ko'rsatish markazi bilan bog'laning. Ruxsat berilmagan o'zgartirishlar foydalanuvchini ushbu mahsulotdan foydalanish huquqidan mahrum bo'lishi mumkin.
- Faqat LG Electronics tomonidan tasdiqlangan ruxsat berilgan biriktirmalar / aksessuarlardan foydalaning. Aks holda bu yong'in, elektr toki urishi, noto'g'ri ishlash yoki mahsulotga zarar yetishiga olib kelishi mumkin.
- O'zgaruvchan tok adapteri va elektr shnurini hech qachon qismlarga ajratmang. Bu yong'in yoki elektr toki urishiga olib kelishi mumkin.
- Adapter tushib ketmasligi uchun uni mahkam va ehtiyotkorlik bilan ushlang. Zarba tegishi adaptorni buzishi mumkin.
- Yong'in yoki elektr toki urishining oldini olish uchun TVni nam qo'lingiz bilan ushlamang. Agar elektr shnur tilchasi nam yoki chang bilan qoplangan bo'lsa, vilkani to'liq quriting yoki changlarni artib tashlang.
- **Batareyalari**
 - Aksessuarlarni (batareya va boshq.) bolalar qo'li yetmaydigan xavfsiz joyda saqlang.
 - Batareyalarni bir-biriga tutashirmang, ularni bo'laklarga ajratmang yoki ularning qizib ketishiga yo'l qo'ymang. Batareyalarni olovga yaqin qoldirmang. Batareyalarni ortiqcha issiqlik ta'sirida qoldirmaslik lozim.
- **Ko'chirish**
 - Ko'chirish vaqtida mahsulot o'chirilganligiga, rozetkadan uzilganligi va barcha kabellar ajratilganligiga ishonch hosil qiling. Kattaroq TVlarni ko'tarish uchun 2 yoki undan ko'proq kishi kerak bo'lishi mumkin. TVning old panelini bosmang yoki unga hech nimani tiyamang. Aks holda, bu mahsulotga zarar yetishi, yong'in chiqishi yoki shikast yetishi mumkin.
- Namga qarshi qadoqlash materiallari yoki vinil qadoqni bolalarning qo'llari yetmaydigan joylarda saqlang.
- Zarba bo'lishiga, hech qanday obyektning mahsulot ichiga tushib ketishiga yo'l qo'ymang va ekran ustiga hech narsagi tushirib yubormang.
- Panelni qo'lingiz yoki mix, qalam yoki ruchka kabi o'tkir narsalar bilan kuchli bosmang yoki uni tinamang. U ekranga zarar yetkazishi mumkin.
- **Tozalash**
 - Tozalayotganda, elektr shnurni qivvat manbaidan uzing va yumshoq/qruruq material bilan ohista arting. Suv yoki boshqa suyuqliklarni TVga sepmang. Mahsulotlar va uning panelini shikastlaydigan oynak tozalash vositasi, havo tozalagich, insektitsidlar, surma yog'lar, mum (avtomobilga oid, industrial), abraziv narsalar, eritkich, benzin, alkogol va hokazolardan foydalanmang. Aks holda bu elektr toki urishi yoki mahsulotga zarar yetishiga olib kelishi mumkin.

Tayyorlash

- Agar televizor zavoddan chiqarilgandan keyin ilk marta yoqilgan bo'lsa, uning initsializatsiyasi uchun bir necha daqiqa vaqt sarflanishi mumkin.
- Ko'rsatilgan tasvir televizoringizdagi farqlanishi mumkin.
- Televizoringizdagi OSD (display ekranini) ushbu qo'llanmada ko'rsatilganidan biroz farq qilishi mumkin.
- mavjud mayjular va parametrlar kirish manbasi yoki siz foydalanayotgan mahsulot rusumidagidan farq qilishi mumkin.
- Kelajakda ushbu televizorga yangi funksiyalar qo'shilishi mumkin.
- Qurilmadan kirishga yaqin bo'lgan rozetkaga o'tish oson bo'lishi lozim. Ayrim qurilmalarda yoqish / o'chirish tugmasi bilan yoqilmasligi mumkin, qurilmani o'chirish uchun elektr shnurini uzish kerak bo'ladi.
- Mahsulotingiz bilan yetkazib beriladigan buyumlar rusumga bog'liq ravishda turlicha bo'lishi mumkin.
- Mahsulot texnik xususiyatlari yoki ushbu qo'llanma tarkibiy qismiga mahsulot funksiyalarining yangilanishi tufayli avvaldan ogohlantirishsiz o'zgartirishlar kiritilishi mumkin.
- Eng maqbul darajada ulanish uchun HDMI kablari va USB qurilmalari qalinligi 10 mm dan, kengligi 18 mm dan kamroq bo'lgan uyachalarga ega bo'lishi kerak. USB kabeli yoki USB xotira kartasi televizoringizdagi USB portiga mos kelmagan hollarda USB 2.0 ga mos uzaytirma kabeldan foydalaning.

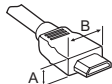

* $A \leq 10 \text{ mm}$

* $B \leq 18 \text{ mm}$

- HDMI logotipi yopishtirilgan tavsiya etilgan kabeldan foydalaning.
- Agar tavsiya etilgan HDMI kabelidan foydalanmasangiz, ekran namoyish qilmasligi yoki ulanishda xatolik yuz berishi mumkin. (Tavsiya qilingan HDMI kabeli turlari)
 - Ultra High-Speed HDMI[®]/™ kabel (3 m yoki kamroq)
- Ferrit yadrosi qo'llash usuli (Faqat 24LT66*)
 - Quvvat ta'minoti kabelidagi yoki Komponent portlar elektromagnit to'siqlarini kamaytirish uchun temir o'zakdan foydalaning. Quvvat ta'minoti kabelini temir o'zakka bir marta o'rang.

(Faqat 24LT66*)

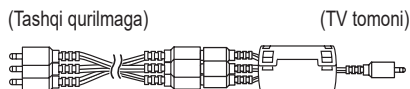
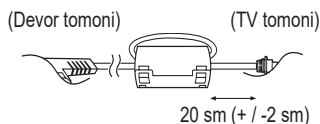

Alohida xarid

Sifat darajasini yaxshilash maqsadida alohida xarid qilinadigan buyumlar ro'yxati hech qanday ogohlantirishsiz almashtirilishi yoki unga o'zgartirishlar kiritilishi mumkin. Ushbu buyumlarni xarid qilish uchun o'z dileringizga murojaat qiling. Ushbu qurilmalar faqat ma'lum rusumlardagina ishlaydi.

Rusum nomi yoki tuzilishi mahsulot funksiyalarining yangilanishi, ishlab chiqaruvchining vaziyati va ko'rsatmalariga asoslangan holda o'zgartirilishi mumkin.

LED soat

(Rusumga qarab)

LEC-005

Magic masofadan boshqarish pult

(Rusumga qarab)

AN-MR18HA

TV uchun Magic masofadan boshqarish pultidan foydalanish mumkinligini tekshirish uchun TV modeli Simsiz module sharoitida Bluetooth'ni qo'llab-quvvatlashini tekshiring.

Taglik

(Faqat UT782*, UT662*)

Taglik	Rusum
AM-ST19BA	43UT782H0ZA
	43UT782H1ZA
	43UT782V0ZA
	43UT782V0ZC
	43UT782V2ZA
AM-ST19CA	43UT782H9ZA
	43UT782V9ZC
	43UT782V9ZA
AM-ST19CA	43UT662H0ZC
AM-ST18CA	43UT662H2ZC
	49UT662H0ZB
AM-ST19CC	49UT662H2ZB
	55UT662H0ZC
AM-ST19CD	55UT662H2ZC
	65UT662H0ZC

Devorga mahkamlash kronshteynlari

VESA (Videoelektronikasi Standartlashtirish Uyushmasi) talablariga javob beruvchi burama mixlar va devorga mahkamlanadigan tayanchdan foydalaning. Devorga o'rnatishda foydalaniladigan to'plam uchun standart o'lchamlar quyidagi jadvalda keltirilgan.

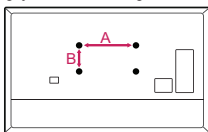

Rusum	43UT78* 49UT76* 43UT66* 43UT64* 32LT66*	55UT76* 49/55UT66* 49/55UT64*
VESA (A x B) (mm)	200 x 200	300 x 300
Standart burama mix	M6	M6
Burama mixlar soni	4	4
Devorga mahkamlanadigan tayanch	LSW240B MSW240	OLW480B MSW240
Rusum	65UT76* 65UT66* 60/65UT64*	70/75UT64*
VESA (A x B) (mm)	300 x 300	600 x 400
Standart burama mix	M6	M8
Burama mixlar soni	4	4
Devorga mahkamlanadigan tayanch	OLW480B	LSW640B
Rusum	24LT66*	28LT66*
VESA (A x B) (mm)	75 x 75	100 x 100
Standart burama mix	M4 X L10	M4 X L10
Burama mixlar soni	4	4
Devorga mahkamlanadigan tayanch	LSW140B	LSW149

Televizorni ko'tarish va siljitish

Iltimos, televizorning turi va hajmidan qat'iy nazar televizorning tiralishi yoki unga zarar yetishi xavfining oldini olish va uni xavfsiz tarzda tashish uchun quyidagi maslahatlarga amal qiling.

- Televizorni u dastlab olib kelingan quti yoki o'ramda siljitish tavsiya qilinadi.
- Televizorni siljitish yoki ko'tarishdan avval undagi quvvat manbaiga ulash shnuri va barcha kabellarni uzib qo'ying.
- Televizorni ushlab turganda unga zarar yetishining oldini olish uchun uning ekrani sizga teskari holda bo'lishi kerak.



- Televizor korpusining yuqori va quyi qismlarini mahkam ushlang. Shaffof qismi, dinamik yoki dinamikning to'rtli qismidan ushlab olmaganligingizga ishonch hosil qiling.

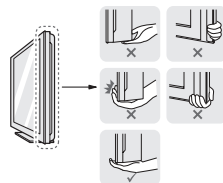

- Katta televizorlarni tashish uchun kamida ikki kishi bo'lishi kerak.
- Televizor qo'lda tashilgan vaqtda uni quyidagi tasvirida ko'rsatilgani kabi ushlang.

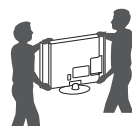

- Televizorni tashish vaqtida uni zarbalar yoki ortiqcha tebranishlar ta'sirida qoldirmang.
- Televizorni tashish vaqtida uni vertikal holatda ushlang, hech qachon televizorni yon tomonga burmang va chapga yoki o'ngga qiyalatmang.
- Rama shassilarining bukilishi/egilishiga olib keluvchi ortiqcha bosim ishlatmang, chunki bu ekranga zarar yetkazishi mumkin.
- Televizor bilan muomala qilganda bo'rtib turgan tugmalarni shikastlamalik uchun ehtiyot bo'ling.



- Hamma vaqt ekranga tegib turishdan saqlaning, chunki bu ekran buzilishiga olib kelishi mumkin.
- Kabellarni tutqichlaridan ushlagan holda televizorni siljiltmang, chunki ular sinishi va buning natijasida shikastlanish yoki televizorga zarar yetkazishi mumkin.
- Tayanchni TVga mahkamlashda ekranni timalishlardan himoya qilish uchun ekranni yumshoq stol yoki tekis yuzaga qaratgan holda qo'ying. (Rusumga qarab)

Stol ustiga o'rnatish

(Rusumga qarab)

- 1 Televizorni ko'taring va uni vertikal holatga keltirgan holda stol ustiga qo'ying.
 - Yetarlicha havo aylanib turishi uchun devor bilan televizor orasida (eng kamida) 10 sm masofa qoldiring.

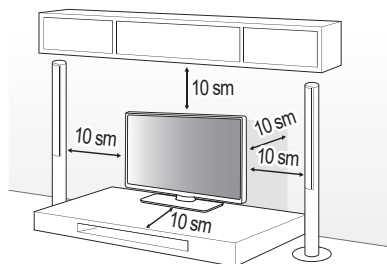

(Rusumga qarab)

- 2 Quvvat manbai shnurini rozetkaga ulang.



- Mahsulotni yig'ish paytida burama mix qismlariga begona moddalarni (moylar, moylash materiallari, va hokazolar) qo'llamang. (Bunday qilish mahsulotga shikast yetkazishi mumkin.)
- Agar siz televizorni tayanchga o'rnatmoqchi bo'lsangiz, mahsulotning ag'darilib ketishining oldini olish bo'yicha choralar ko'rishingiz kerak bo'ladi. Aks holda, televizor tushib ketishi, bu esa shaxsiy zarar xavfiga olib kelishi mumkin.
- Xavfsizlik va mahsulotning xizmat ko'rsatish davomiyligini kafolatlash uchun ruxsatnomaga ega bo'lmagan buyumlardan foydalanmang.
- Ruxsat berilmagan buyumlardan foydalanish orqali yetkazilgan har qanday zarar yoki shikastlanishlar ishlab chiqaruvchi kafolati orqali qoplanmaydi.
- Burama mixlarning to'g'ri kiritilganligi va mahkam qotirilganligiga ishonch hosil qiling. (Agar ular yetarli darajada mahkam qotirilmagan bo'lsa, TV o'rnatilgandan keyin oldinga qulab ketishi mumkin.) Ortiqcha ko'p kuch ishlatmang yoki burama mixlarni ortiqcha qotirib yubormang; aks holda burama mix shikastlanishi va to'g'ri qotirilmasligi mumkin.

Televizorni stolga mahkamlash

(Rusumga qarab)

TV oldinga/orqaga surilmasligi va buning natijasida mahsulotga zarar yetmasligi uchun u stol ustiga mahkamlanishi zarur.

A tur

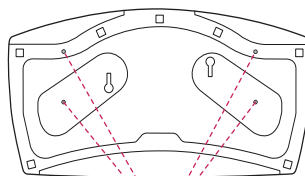

4 ta vint
(TV bilan birga taqdim etilmaydi)

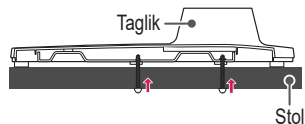

- Burama mix: M5 x L (*L: Stol chuqurligi + 8~10 mm) misol) Stol chuqurligi: 15 mm, Burama mix: M5 x L25

B tur

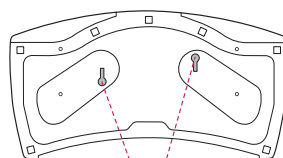

Taglikni qotirish uchun 2 ta vint,
Taglikni qotirish uchun 2 ta bolt,
Taglikni qotirish uchun 2 ta gayka
(TV bilan birga taqdim etiladi)

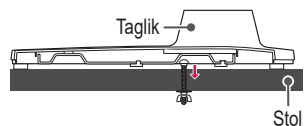

Kensington xavfsizlik tizimidan foydalanish

(Rusumga qarab)

Kensington xavfsizlik tizimi konnektori TVning orqa tomonida joylashgan. O'rnatish va foydalanish to'g'risida qo'shimcha ma'lumot olish uchun Kensington xavfsizlik tizimi tomonidan taqdim etilgan qo'llanmaga qarang yoki <http://www.kensington.com> saytiga tashrif buyuring. TV va stol orasiga Kensington xavfsizlik tizimi kabelini ulang.

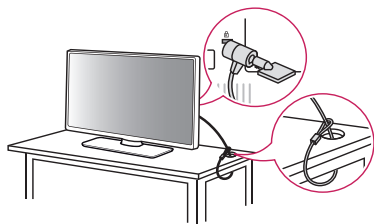

(Rusumga qarab)

Televizorni devorga mahkamlash

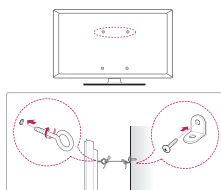

(Rusumga qarab)

- 1 Teshikli boltlar yoki devorga mahkamlanadigan tayanch va boltlarni televizorning orqa paneliga kiriting va tortib mahkamlang.
 - Agar teshikli boltlar o'rnida boltlar o'rnatilgan bo'lsa, ularni olib tashlang.
 - 2 Tayanchlarni boltlar yordamida devorga o'rnatish. Tayanch va televizor orqa panelidagi teshikli boltlarning joylashuv o'rinlarini moslashtiring.
 - 3 Teshikli boltlar va tayanchlarni mustahkam bog'lagich bilan ulang. Bog'lagich tekis sirtida gorizontol holatda bo'lishiga ishonch hosil qiling.
- Televizor mahkam turishi uchun yetarli darajada mustahkam va katta platforma yoki shkafdan foydalaning.
 - Tayanch moslamalar, boltlar va bog'lagichlar mahsulot bilan birga yetkazib berilmaydi. Qo'shimcha qurilmalar uchun mahalliy dileringizga murojaat qiling.

Devorga montajlash

Devorga o'rnatiladigan tayanchni televizorning orqa tarafiga ehtiyotlik bilan mahkamlang va uni mustahkam devorga polga perpendikulyar holda o'rnatish. Televizorni boshqa qurilish mollarga birlashtirishda malakali xodimga murojaat qiling. LG devorga o'rnatishni malakali mutaxassis tomonidan amalga oshirilishini tavsiya qiladi. Biz LGning devorga o'rnatish kronshteynidan foydalanishni tavsiya qilamiz. LG-ning devorga o'rnatish kronshteynini ulangan kabellar bilan joyini o'zgartirish osondir. Iltimos, LGning devorga o'rnatish kronshteynidan foydalanilmagan holatlarda, tashqi qurilmalarga ulanish uchun yetarlicha joy bilan ta'minlangan va devorga mahkam qotirilgan devor kronshteynidan foydalaning. Qotirilgan devorga o'rnatish kronshteynini o'rnatishdan oldin barcha kabellarni ulash tavsiya qilinadi.

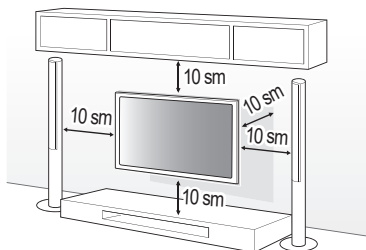

- Televizorni devorga o'rnatishdan avval tayanchni mahkamlash harakatlarini teskari tartibda bajargan holda tayanchi televizordan ajratib oling. (Rusumga qarab)
- Vint va tayanch montajlash konstruksiyasi haqida batafsil ma'lumot olish uchun Alohida xaridga qarang.
- Agar siz mahsulotni devorga o'rnatmoqchi bo'lsangiz, VESA (Videoelektronikani Standartlashtirish Uyushmasi) standartiga mos keladigan o'rnatish interfeysini (ixtiyoriy qismlarni) mahsulotning orqa tarafiga mahkamlang. Televizorni devorga mahkamlanadigan tayanchdan (ixtiyoriy qismlardan) foydalangan holda o'rnatishda uning tushib ketmasligi uchun tayanchni mustahkam qotiring.
- TVni devorga montajlash vaqtida elektr va signal kabellarini TVning orqasidan osilib turadigan qilib osmang.
- Agar ushbu mahsulot moy yoki moyli tuman ta'siriga uchrashi mumkin bo'lsa, uni devorga o'rnatmang. Bu mahsulotni buzishi va uning tushib ketishiga sabab bo'lishi mumkin.

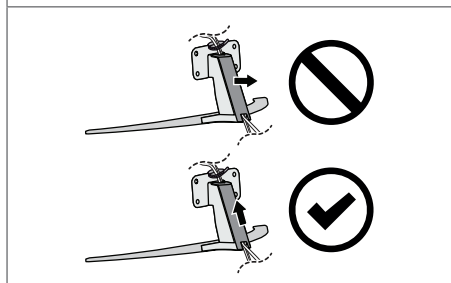
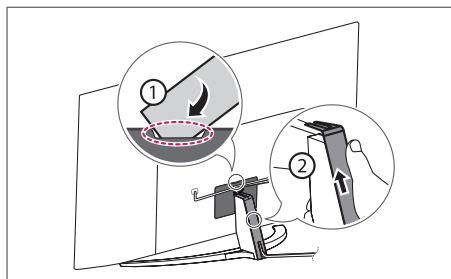

(Rusumga qarab)



- Kabel qoplamasini ajratib olganingizda o'tkir ob'ektidan foydalanmang. Bu kabel yoki shkafni buzishi mumkin. Shuningdek, bu odamga zarar yetkazishi mumkin. (Rusumga qarab)

- Devorga o'rnatish kronshteynini o'rnatish vaqtida tasmadan foydalangan holda chang va hasharotlar oqimini oldini olish uchun tayanch teshigini himoya qilish tavsiya qilinadi. (Rusumga qarab)

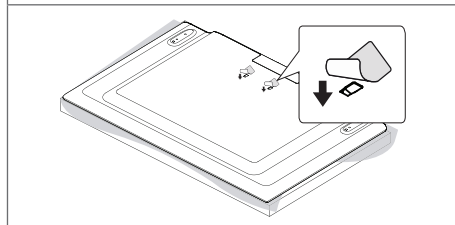
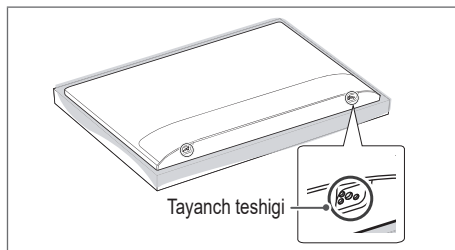

- Burama mixning orqa qopqoq tashqi yuzasidan uzunligi 8 mm bo'lishi lozim. (Faqat 24/28LT66*)

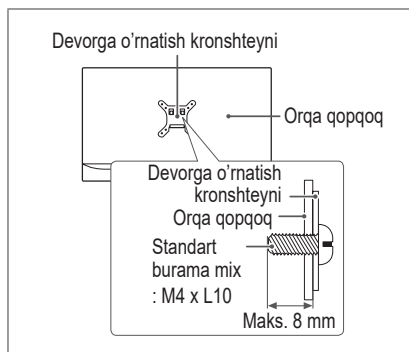

Ulanishlar

Istalagan tashqi qurilmani televizorga ulang va tegishli qurilmani tanlash uchun kirish manbasini o'zgartiring. Tashqi qurilmani ulash bo'yicha qo'shimcha ma'lumotlar olish uchun har bir qurilma bilan taqdim qilibadigan qo'llanmaga qarang.

Antenna/Kabel

Televizorni devordagi antenna uyachasiga RF kabeli (75 Ω) bilan ulang.

- 2 tadan ko'proq televizordan foydalanish uchun signal splitteridan foydalaning.
- Agar tasvir sifati yomon bo'lsa, tasvir sifatini yaxshilash uchun signal kuchaytirgichni to'g'ri o'rnatib.
- Agar antenna ulangan holda tasvir sifati yomon bo'lsa, antennani to'g'ri yo'naltirishga harakat qiling.
- Antenna kabeli va konverter qurilma bilan birga berilmaydi.
- ULTRA HD efirga uzatuv uchun mo'ljallanmagan hudud ichida televizor ULTRA HD efirga uzatuv signallarini qabul qila olmaydi. (Rusumga qarang)

Sun'iy yo'ldosh antennisasi

Televizorni sun'iy yo'ldosh antennisasidagi sun'iy yo'ldosh uyachasiga RF kabeli (75 Ω) bilan ulang. (Rusumga qarang)

CI moduli

Raqamli televideniye rejimida shifrlangan (pullik) xizmatlardan foydalaning. (Rusumga qarang)

- CI modulining PCMCIA kartasi slotiga to'g'ri yo'nalishda kiritilganligini tekshiring. Agar modul to'g'ri kiritilmagan bo'lsa, bu televizor va PCMCIA kartasi slotining buzilishiga olib kelishi mumkin.
- Agar CI+ CAM ulangan vaqt televizor hech qanday video va audio tarkibini namoyish qilmasa, Antenna/Kabel/Sun'iy yo'ldosh xizmat operatoriga murojaat qiling.



Boshqa ulanishlar

Televizoringizni tashqi qurilmalarga ulang. Yuqori sifatti tasvir va audio uchun televizoringizni tashqi qurilmaga HDMI kabeli bilan ulang. Ba'zi alohida kabellar qurilma bilan birga taqdim qilinmaydi.

HDMI

- Qo'llab-quvvatlanadigan HDMI audio formatlari: (Rusumga qarang)
 - DTS (44,1 kHz / 48 kHz / 88,2 kHz / 96 kHz),
 - DTS HD (44,1 kHz / 48 kHz / 88,2 kHz / 96 kHz / 176,4 kHz / 192 kHz),
 - Dolby Digital / Dolby Digital Plus (32 kHz / 44,1 kHz / 48 kHz),
 - PCM (32 kHz / 44,1 kHz / 48 kHz / 96 kHz / 192 kHz)

(Faqat UHD modellar)

- **SMART** →  →  → [Rasm] → [Qo'shimcha sozlamalar] → [HDMI ULTRA HD Deep Colour]
 - Yoqish: 4K @ 50/60 Hz (4:4:4, 4:2:2, 4:2:0) ni qo'llab-quvvatlaydi.
 - O'chirish: 4K @ 50/60 Hz 8 bit (4:2:0) ni qo'llab-quvvatlaydi.

Agar Kirish Manbasi Portuga ulangan qurilma ham ULTRA HD DEEP COLOURga mos kelsa, tasvir yanada tiniqroq bo'ladi. Biroq, agar qurilma ushbu formatga mos tushmasa, u noto'g'ri ishlashi mumkin. Bunday holatda Tvning [HDMI ULTRA HD Deep Colour] sozalamasini o'chiring.

USB

Ayrim USB xabarlari ishlamasligi mumkin. USB xabidan foydalanib, ulangan USB qurilmasi aniqlanmagan hollarda uni to'g'ridan-to'g'ri televizordagi USB portiga ulang.

- Veb-kamerani ulayotganda USB 1 portdan foydalaning. USB 2 porti ayrim veb-kamerallarni qo'llab-quvvatlamasligi mumkin. (Rusumga qarang)
- Quvvat ta'minotiga ega USB xab yoki USB qattiq diskdan foydalanish tavsiya etiladi. (Agar ta'minlanayotgan quvvat yetarli bo'lmasa, USB xotira qurilmasi to'g'ri aniqlanmasligi mumkin.)
- 5 V yoki undan pastroq nominal kuchlanish va 500 mA yoki undan kamroq nominal tokda ishlaydigan tashqi USB qattiq diskdan foydalanish tavsiya etiladi.

Tashqi qurilmalar

Foydalanish mumkin bo'lgan tashqi qurilmalar: Blu-ray pleyer, HD qabul qiluvchilari, DVD pleyerlar, VCR'lar, audio tizimlar, USB saqlash qurilmalari, SHK, o'yin qurilmalari va boshqa tashqi qurilmalar.

- Tashqi qurilmani ulash rusumga bog'liq holda farq qilishi mumkin.
- Tashqi qurilmalarni televizor portlari tartibiga bog'liq bo'lmagan holda televizorga ulang.
- Foydalanish bo'yicha ko'rsatmalar olish uchun tashqi qurilma qo'llanmasiga qarang.
- O'yin qurilmasini televizorga ulash uchun o'yin qurilmasi bilan birga yetkazib berilgan kabeldan foydalaning.
- Kompyuter rejimida tasvir aniqligi, vertikal namunalar, kontrast yoki ravshanlik bilan bog'liq shovqinlar mavjud bo'lishi mumkin. Agar shovqinlar mavjud bo'lsa, kompyuter chiqishini boshqa tasvir aniqligiga o'zgartiring, yangilash intervalini boshqasiga sozlang yoki TASVIR menyusida tasvir aniq bo'lguniga qadar ravshanlik va kontrast darajasini o'zgartiring.
- Kompyuter rejimida ayrim tasvir aniqligi sozlanmalari videokartaga bog'liq ravishda kutilganidek ishlamasligi mumkin.
- Agar SHKda ULTRA HD tarkib namoyish qilinsa, SHKning ishlash samaradorligiga qarab video yoki audio namoyish vaqti-vaqti bilan uzilishi mumkin. (Rusumga qarab)
- Simli LAN orqali ulayotganda CAT 7 kabelidan foydalanish tavsiya qilinadi. (Faqat LAN port mavjud bo'lganda.)

Tashqi karnaylar

(Rusumga qarab)

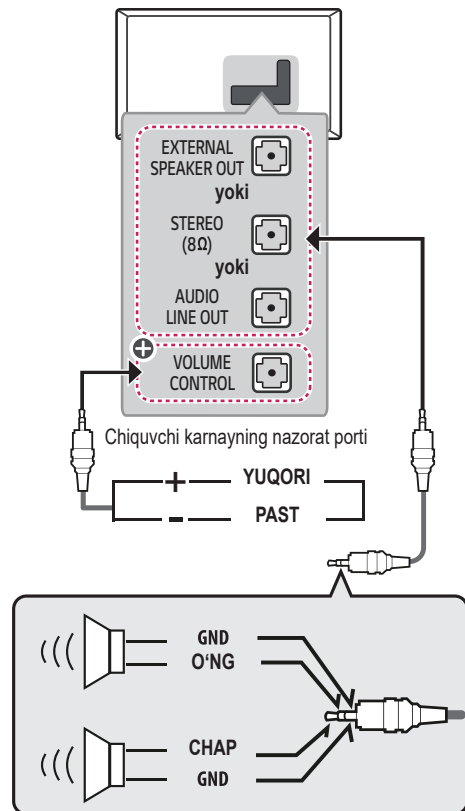

⊕ : Rusumga qarab



- Faqat 3 qutbli 3,5 mm'li Stereo uya bilan foydalaning.
- Tashqi karnayni ulash uchun quloqlik yoki quloqchiningizni portga ulamang.

Ovozni boshqarish portini boshqarish usullari

(Rusumga qarab)

- Kabel tur.

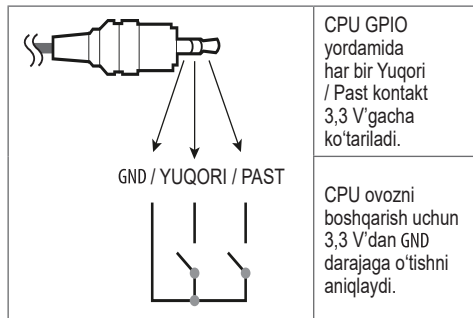

Tarmoq

(Rusumga qarab)

Simli tarmoq ulanishi

Bu TV Pro:Centric serveriga LAN porti orqali ulanishi mumkin. Jismoniy ulanish amalga oshirilgandan so'ng, TV'da tarmoq kommunikatsiyasi sozlanishi lozim.

Modem yoki routingning LAN portini Pro:Centric serveridan TVdagi LAN portiga ulang.

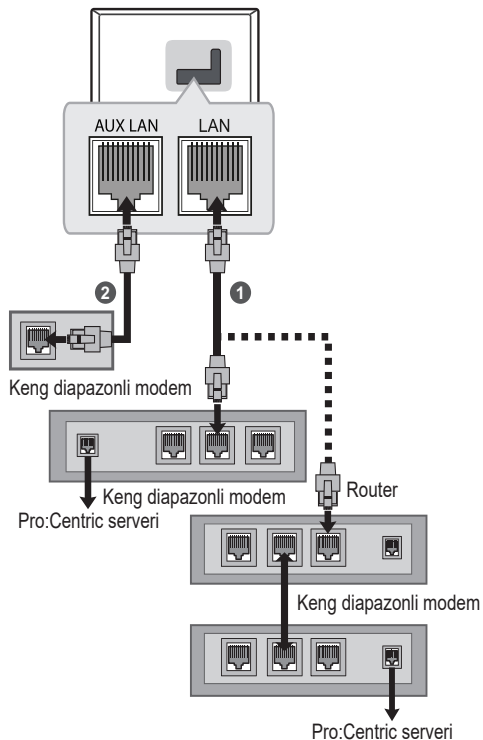

❶ Modem yoki routingning LAN portini TVdagi LAN portiga ulang.

❷ ShKning LAN portini TVdagi AUX LAN portiga ulang. (Rusumga qarab)



- Modulli telefon kabelini LAN portiga ulamang.
- Turli ulanish usullari bo'lganligi sababli telekommunikatsiya operatoringiz yoki internet xizmati ta'minotchingiz ko'rsatmalariga rioya qiling.

Tugmadan foydalanish

(Rusumga qarab)

TV funksiyalarini osongina mos tugmalar yordamida ishlatishingiz mumkin.

<A tur>

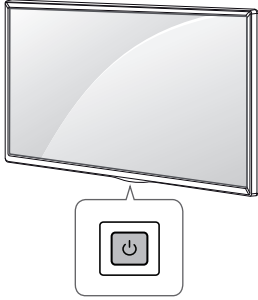

<B tur>

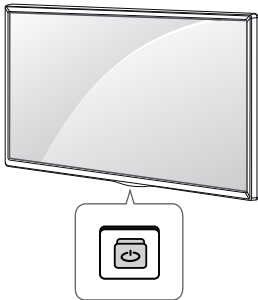

Asosiy funksiyalar

<A tur>

	Yoqish (Bosish) O'chirish ¹ (Bosib ushlab turish) Menyu boshqaruvi (Bosish ²) Menyu tanlovi (Bosib ushlab turish ³)
--	---

<B tur>

	Yoqish (Bosish) O'chirish ¹ (Bosib ushlab turish)
	Ovozni boshqarish
	Dasturlar boshqaruvi

- 1 Barcha ishlayotgan ilovalar yopiladi.
- 2 Menyu bo'ylab harakat qilish uchun TV yoqilgan bo'lganda tugmani qisqacha bosib.
- 3 Menyuga kirdandan keyin ushbu funksiyadan foydalanishingiz mumkin.

Menyuni sozlash

(Rusumga qarab)

TV yoqilgan bo'lganda, tugmasini bir marta bosib. Menyu elementlarini mos tugma yordamida o'zgartirishingiz mumkin.

	Televizorni o'chiradi.
	Kirish manbasini o'zgartiradi.
	Saqlab olingan kanallar bo'ylab o'tkazadi.
	Ovoz balandligi darajasini sozlaydi.
	Parametrlar menyusiga kiradi.
	Ekranni mavjud tasvirlardan tozalaydi va televizor ko'rish rejimiga qaytaradi.

Yaxshi ko'rinishi uchun TV burchagini sozlash

(Rusumga qarab)

Ekran yaxshi ko'rinishi uchun TV burchagini 20 daraja chap yoki o'ngga aylantirish orqali sozlang.

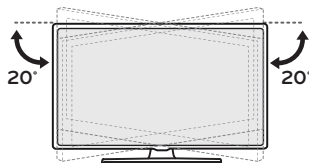

- Mahsulot burchagini sozlayotganda barmoqlaringizga ehtiyot bo'ling.
- Qo'l yoki barmog'ingizni qisib olsangiz, bu sizga shikast yetkazishi mumkin. Agar mahsulot ortiqcha darajada og'dirilgan bo'lsa, u tushib ketishi va natijada buzilishi yoki unga zarar yetishi mumkin.

Masofadan boshqarish pultidan foydalanish

Ushbu qo'llanmadagi tavsiflar masofadan boshqarish pultidagi tugmalarga asoslangan. Iltimos, ushbu qo'llanmani diqqat bilan o'qib chiqing va televizordan to'g'ri foydalaning.

Batareyalarni almashtirish uchun batareya qo'yish bo'lmasi qopqog'ini oching, ⊕ va ⊖ uchlari bo'lma ichidagi yoriqqam mos bo'lgan batareyalar (1,5 V AAA) bilan almashtiring va batareya qo'yish bo'lmasi qopqog'ini yoping. Batareyalarni olib tashlash uchun o'rnatish harakatlarni teskari tartibda bajaring.

Masofadan boshqarish pultini televizordagi masofadan boshqarish sensoriga yo'naltirganligingizga ishonch hosil qiling.

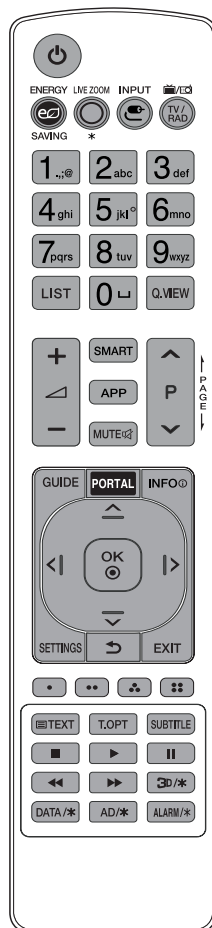

(Rusum yoki hududga qarab ayrim tugmalar va xizmatlar mavjud bo'lmasligi ham mumkin.)

* **Tugmadan foydalanish uchun uni 3 soniyadan ko'proq bosib turing.**

 **(QUVVAT)** Televizorni o'chiradi va yoqadi.

 **ENERGY SAVING** Quvvat tejash uchun ekran yorqinligini sozlaydi.

 **OLIVE ZOOM** * Bu funktsiya qo'llab-quvvatlanmaydi.

 **INPUT** Kirish manbasini o'zgartiradi.

 **TV/RAD**   Radio, televizor va DTV dasturini tanlaydi.

Raqamli tugmalar Raqamlarni kiritadi.

Alifbo tugmalari Harflarni kiritib.

LIST Saqlab olingan kanallar ro'yxatiga kiradi.

 **(BO'SH JOY)** Ekrandagi klaviaturada bo'sh joyini ochadi.

Q.VIEW Avvalgi ko'rilgan kanalga qaytaradi.

 **+**  **—** Ovoz balandligi darajasini sozlaydi.

SMART Uy menyusiga qaytaradi.

SMART Avvalgi tarixni ko'rsatadi.

APP Avvalgi tarixni ko'rsatadi.

MUTE  Barcha ovozlarni o'chiradi.

MUTE  [Maxsus imkoniyat] menyusiga kiradi.

 **P**  **V** Saqlab olingan kanallar bo'yab o'tkazadi.

 **PAGE**  Avvalgi yoki keyingi ekranga o'tkazadi.

GUIDE Teledasturlar ro'yxatini ko'rsatadi.

PORTAL Mehmonxona interaktiv menyusini ko'rsatadi va olib tashlaydi.

INFO  Joriy dastur va ekran to'g'risidagi ma'lumotni ko'rsatadi.

Yo'naltirish tugmalari (yuqoriga/pastga/chapga/o'ngga)





Menyular yoki parametrlar bo'yab ko'rish imkonini beradi.

OK  Menyular yoki parametrlarni tanlaydi va siz kiritgan ma'lumotlarni tasdiqlaydi.

SETTINGS Asosiy menyularga kiradi.

 **(ORQAGA)** Avvalgi holatga qaytaradi.

EXIT Ekranni mavjud tasvirlardan tozalaydi va televizor ko'rish rejimiga qaytaradi.

    Bular ayrim menyulardagi maxsus funktsiyalarga kirish imkonini beradi.

Telematn tugmalari  **TEXT, T.OPT** Ushbu tugmalardan telematnlar uchun foydalaniladi.

SUBTITLE O'zingiz istagan subtitrni raqamli rejimda namoyon qiladi.

Boshqaruv tugmalari      Media tarkiblarni boshqaradi.

 ***/** Bu funktsiya qo'llab-quvvatlanmaydi.

DATA ***/** MHP (Multimedia uy platformasi) televizori menyusini manbasini tanlaydi.

AD ***/** Audio tavsif funktsiyasi yoqiladi.

ALARM ***/** Uyg'otgich funktsiyasini o'rnatadi.



- Yangi batareyalarni eski batareyalar bilan aralash o'rnatmang. Bu batareyalarning haddan ziyod qizib ketishi va natijada oqishiga olib kelishi mumkin.
- Batareyaning qutblari to'g'ri qo'yilmasa, batareya portlashi yoki suyuqlik chiqarishi mumkin, natijada yong'in chiqishi, tan jarohati yetishi yoki atrof-muhit ifloslanishi mumkin.
- Bu aparatlar batareyadan foydalanadi. Hamjamiyatingizda atrof-muhitni muhofaza qilish maqsadida bu batareyalarni to'g'ri ulizatsiya qilinishini talab qiluvchi qonunlar mavjud bo'lishi mumkin. Joylashtirish yoki ulizatsiya ma'lumotlari uchun mahalliy boshqaruv organlari bilan bog'laning.
- Mahsulotning ichki va tashqi batareyalari to'g'ridan-to'g'ri quyosh nuri, yong'in yoki shunga o'xshash narsalar ta'siri ostida bo'lmasligi zarur.

Nosozliklarni bartaraf qilish

Samaradorlikni yaxshilash uchun dasturiy ta'minot versiyasi yangilanishi mumkin.

Mijoz o'z moslamasi LGE dasturiga mos kelishiga ishonch hosil qilishi zarur. Zarur bo'lsa, LGE bilan maslahatlashing va LGE tomonidan taqdim etilgan yo'riqnoma ko'rsatilgan dasturiy ta'minot versiyasini yuklang.

Televizorni masofadan boshqarish pulti orqali boshqarishning iloji yo'q.

- Mahsulot masofadan boshqarish pulti sensorini tekshiring va qaytadan urinib ko'ring.
- Mahsulot va masofadan boshqarish pulti orasida hech qanday to'siqning mavjud emasligini tekshiring.
- Batareyalarning ishlayotganligi va to'g'ri o'rnatilganligini (+ ga ⊕, - ga ⊖) tekshiring.

Tasvir namoyishi va ovoz mavjud emas.

- Mahsulotning yoqilganligini tekshiring.
- Quvvat manbaiga ulash shnurining rozetkaga ulanganligini tekshiring.
- Boshqa qurilmalarni ulab ko'rish yo'li bilan rozetkaning ishlayotganligini tekshirib ko'ring.

Televizor to'satdan o'chib qoladi.

- Quvvat boshqaruvi sozlanmalarini tekshiring. Quvvat ta'minoti uzilgan bo'lishi mumkin.
- Vaqtga bog'liq sozlamalarda avtomatik o'chirish funksiyasi faollashtirilganligini tekshiring.
- Televizor yoqilgan vaqtda signal mavjud bo'lmasa, 15 daqiqalik faolsizlikdan keyin televizor avtomatik ravishda o'chadi.

ShKga ulanayotganda (HDMI), signal aniqlanmadi.

- Masofadan boshqarish pultidan foydalangan holda televizorni o'chiring va yoqing.
- HDMI kabelini qaytadan ulang.
- Televizor yoqilgan holda kompyuterni o'chirib yoqing.

Noto'g'ri ko'rsatayotgan ekran

- Agar mahsulotga tegilganda sovuqdek tuyulsa, u yoqilganda ozgina millitillash bo'lishi mumkin. Bu tabiiy holdir; mahsulotda hech qanday muammo mavjud emas.
- Bu panel millionlab pikselni o'z ichiga olgan ilg'or mahsulot hisoblanadi. Siz panelda o'lchami 1 ppm bo'lgan kichkina qora nuqtalarni va/yoki yorqin (qizil, ko'k, yashil) rangdagi nuqtalarni ko'rishingiz mumkin. Bu mahsulotning noto'g'ri ishlayotganligini bildirmaydi va ishlash samaradorligiga va mahsulot ishonchligiga ta'sir ko'rsatmaydi. Ushbu hodisa uchinchi tomon ishlab chiqaruvchilarining mahsulotlarida ham sodir bo'lishi mumkin va buning uchun ular almashtirib yoki xarajatlar qoplab berilmaydi.
- Ko'rish nuqtasiga qarab (chap/o'ng/yuqori/past) paneldagi ravshanlik darajasi va ranglar farq qilishi mumkin. Bu hodisa panelning o'ziga xos xususiyatlari tufayli sodir bo'ladi. U ishlash samaradorligi bilan bog'liq emas va uning noto'g'ri ishlayotganligini anglatmaydi.
- Uzoq vaqt davomida harakatsiz tasvirni namoyish qilish qoldiq tasvirga olib kelishi mumkin. TV ekranida uzoq vaqt davomida harakatsiz tasvirning namoyish qilinishiga yo'l qo'yilmang.

Hosil qilingan ovoz

- "Qarsillovchi" shovqin: Televizor ko'rish yoki o'chirish vaqtida chiqadigan qarsillovchi shovqin harorat va namlik tufayli plastik tarkibiy qismlarning qisqarishi orqali hosil qilinadi. Bu harorat natijasida deformatsiyalanish talab qilinadigan mahsulotlar uchun tabiiy hol hisoblanadi.
- Elektr zanjirining guvillashi/panelning g'ong'illashi: Mahsulotni ishlatish uchun katta miqdordagi elektr toki bilan ta'minlovchi yuqori tezlikda o'zgaruvchi zanjir tomonidan sezilarsiz shovqin hosil qilinadi. Shovqin darajasi mahsulotga turiga bog'liq. Ushbu hosil qilingan ovoz mahsulotning ishlash samaradorligiga va uning ishonchligiga ta'sir ko'rsatmaydi.



- Mahsulotni tozalash vaqtida panel yoki yo'naltiruvchi panelning yuqori, chap yoki o'ng tomonidagi tiriqishga har qanday suyuqlik yoki begona ob'yektlar kirmasligiga ehtiyot bo'ling. (Rusumga qarab)

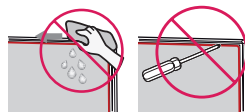

- Ortiqcha suv yoki tozalovchini matodan siqib chiqarganingizga ishonch hosil qiling.
- TV ekrani ustiga to'g'ridan-to'g'ri suv yoki tozalovchini sachratmang.
- Ekranini artish uchun quruq matoga yetarli darajada suv yoki tozalovchi seppishga ishonch hosil qiling.

Texnik xususiyatlar

(Mamlakatga bog'liq)

Efirga uzatish turlari				
	Raqamli TV (Mamlakatga bog'liq)			Analogli TV (Mamlakatga bog'liq)
Televizion tizim	DVB-S/S2 ¹ DVB-T/T2 ¹ DVB-C			PAL/SECAM B/G, D/K, I SECAM L
Kanal qamrovi (Diapazon)	DVB-S/S2 ¹	DVB-C	DVB-T/T2 ¹	46 ~ 862 MHz
	950 ~ 2150 MHz	46 ~ 890 MHz	VHF III: 174 ~ 230 MHz UHF IV: 470 ~ 606 MHz UHF V: 606 ~ 862 MHz S Diapazon II: 230 ~ 300 MHz S Diapazon III: 300 ~ 470 MHz	
Saqlanadigan kanallarning maksimal soni	6000	3000		
Tashqi antenna qarshiligi	75 Ω			
CI Modul o'lchami (K x B x O)	100,0 mm x 55,0 mm x 5,0 mm			

1 Faqat DVB-T2/C/S2¹ni qo'llab-quvvatlovchi model.

Simsiz modul (LGSBWAC92) xususiyatlari	
Simsiz LAN (IEEE 802.11a/b/g/n/ac)	
Chastotalar diapazoni (chegarasi)	Chiqish quvvati unumdroligi (Maks.)
2400 MHz dan 2483,5 MHz gacha	18 dBm
5150 MHz dan 5725 MHz gacha	18 dBm
5725 MHz dan 5850 MHz gacha (Yevropa Ittifoqiga kirmagan mamlakatlarda)	12 dBm
Bluetooth	
Chastotalar diapazoni (chegarasi)	Chiqish quvvati unumdroligi (Maks.)
2400 MHz dan 2483,5 MHz gacha	8 dBm
<p>Kanallar diapazoni mamlakatga ko'ra o'zgarishi mumkinligi sababli foydalanuvchi ishlash chastotasini o'zgartira yoki sozlay olmaydi. Bu mahsulot hududiy chastota jadvali uchun sozlangan.</p> <p>Foydalanuvchi e'tibori uchun: bu mahsulot korpus bilan qurilma orasi kamida 20 sm bo'ladigan tarzda o'rnatilishi va foydalanilishi kerak.</p> <p>"IEEE 802.11ac" hamma mamlakatlarda ham mavjud emas.</p>	

Atrof-muhit holati	
Ishlatish harorati	0 °C dan 40 °C gacha
Ishlatish namligi	80 % dan past
Saqlash harorati	-20 °C dan 60 °C gacha
Saqlash namligi	85 % dan past

HDMI-DTV-ni qo'llab-quvvatlaydigan rejim

Tasvir aniqligi	Gorizontal chastota (kHz)	Vertikal chastota (Hz)
640 x 480p	31,46	59,94
	31,5	60
720 x 480p	31,47	59,94
	31,5	60
720 x 576p	31,25	50
1280 x 720p	44,96	59,94
	45	60
	37,5	50
1920 x 1080i	28,12	50
	33,72	59,94
	33,75	60
1920 x 1080p	26,97	23,97
	27	24
	33,71	29,97
	33,75	30
	56,25	50
	67,43	59,94
1920 x 1080p ¹	112,5	100
	134,86	119,88
	135	120
3840 x 2160p ¹	53,95	23,98
	54	24
	56,25	25
	61,43	29,97
	67,5	30
	112,5	50
	134,86	59,94
	135	60
4096 x 2160p ¹	53,95	23,98
	54	24
	56,25	25
	61,43	29,97
	67,5	30
	112,5	50
	134,86	59,94
	135	60

1 Ushbu modeldan tashqari LT66*

HDMI-PC-ni qo'llab-quvvatlaydigan rejim

- ShK audiosi qo'llab-quvvatlanmaydi.
- ShK rejimi uchun HDMI IN 1 dan foydalaning. (Rusumga qarab)

Tasvir aniqligi	Gorizontal chastota (kHz)	Vertikal chastota (Hz)
640 x 350	31,46	70,09
720 x 400	31,46	70,08
640 x 480	31,46	59,94
800 x 600	37,87	60,31
1024 x 768	48,36	60
1360 x 768	47,71	60,01
1152 x 864	54,34	60,05
1280 x 1024	63,98	60,02
1920 x 1080	67,5	60
1920 x 1080 ¹	134,86	119,88
	135	120
2560 x 1440 ¹	88,78	59,95
3840 x 2160 ¹	53,95	23,98
	54	24
	56,25	25
	61,43	29,97
	67,5	30
	112,5	50
	134,86	59,94
4096 x 2160 ¹	53,95	23,98
	54	24
	56,25	25
	61,43	29,97
	67,5	30
	112,5	50
	134,86	59,94

1 Ushbu modeldan tashqari LT66*

Komponent portga ulash to'g'risidagi ma'lumotlar

(Ushbu modeldan tashqari UT64*)

TVdagi komponent portlar	Y	P _B	P _R
--------------------------	---	----------------	----------------

DVD pleyerdagi video chiqish portlari	Y	P _B	P _R
	Y	B-Y	R-Y
	Y	Cb	Cr
	Y	Pb	Pr

Signal	Tarkibiy qism
480i / 576i	O
480p / 576p	O
720p / 1080i	O
1080p	O

Qo'llab-quvvatlanadigan fotosurat formatlari

Fayl Format	Format	Tasvir aniqligi
.jpeg, .jpg, .jpe	JPEG	Minimal: 64 (K) x 64 (B) Maksimum (Normal Tur): 15360 (K) x 8640 (B) Maksimum (Progressiv tur): 1920 (K) x 1440 (B)
.png	PNG	Minimal: 64 (K) x 64 (B) Maksimum: 5760 (K) x 5760 (B)
.bmp	BMP	Minimal: 64 (K) x 64 (B) Maksimum: 1920 (K) x 1080 (B)

Qo'llab-quvvatlanadigan audio formatlar

Fayl Format	Element	Info
.mp3	Ma'lumotlarni uzatish tezligi	32 Kb/s ~ 320 Kb/s
	Raqamlashtirish chastotasi	16 kHz - 48 kHz
	Qo'llab-quvvatlash	MPEG1, MPEG2
	Kanal	mono, stereo
.wav	Ma'lumotlarni uzatish tezligi	-
	Raqamlashtirish chastotasi	8 kHz - 96 kHz
	Qo'llab-quvvatlash	PCM
	Kanal	mono, stereo
.ogg	Ma'lumotlarni uzatish tezligi	64 Kb/s ~ 320 Kb/s
	Raqamlashtirish chastotasi	8 kHz - 48 kHz
	Qo'llab-quvvatlash	Vorbis
	Kanal	mono, stereo
.wma	Ma'lumotlarni uzatish tezligi	128 Kb/s ~ 320 Kb/s
	Raqamlashtirish chastotasi	8 kHz - 48 kHz
	Qo'llab-quvvatlash	WMA
	Kanal	6 k yuqoriga
.flac	Ma'lumotlarni uzatish tezligi	-
	Raqamlashtirish chastotasi	8 kHz - 96 kHz
	Qo'llab-quvvatlash	FLAC
	Kanal	mono, stereo

- Namunaviy chastotaga qarab qo'llab-quvvatlanadigan dasturlar soni farq qilishi mumkin.

Qo'llab-quvvatlanadigan video formatlar

Kengaytma	Kodek	
.asf .wmv	Video	VC-1 Kuchaytirilgan profil (WMVA bundan mustasno), VC-1 Oddiy va Asosiy profilari
	Audio	WMA Standart (WMA v1/ WMA Speech bundan mustasno)
.avi	Video	Xvid (3 ta nuqtali GMC bundan mustasno), H.264/AVC, Motion Jpeg, MPEG-4
	Audio	MPEG-1 Layer I, II, MPEG-1 Layer III (MP3), Dolby Digital, LPCM, ADPCM, DTS
.mp4 .m4v .mov	Video	H.264/AVC, MPEG-4, HEVC
	Audio	Dolby Digital, Dolby Digital Plus, AAC, MPEG-1 Layer III (MP3), Dolby AC-4
.3gp .3g2	Video	H.264/AVC, MPEG-4
	Audio	AAC, AMR-NB, AMR-WB
.mkv	Video	MPEG-2, MPEG-4, H.264/AVC, VP8, VP9, HEVC
	Audio	Dolby Digital, Dolby Digital Plus, AAC, PCM, DTS, MPEG-1 Layer I, II, MPEG-1 Layer III (MP3)
.ts .trp .tp .mts	Video	H.264/AVC, MPEG-2, HEVC
	Audio	MPEG-1 Layer I, II, MPEG-1 Layer III (MP3), Dolby Digital, Dolby Digital Plus, AAC, PCM, Dolby AC-4
.mpg .mpeg .dat	Video	MPEG-1, MPEG-2
	Audio	MPEG-1 Layer I, II, MPEG-1 Layer III (MP3)
.vob	Video	MPEG-1, MPEG-2
	Audio	Dolby Digital, MPEG-1 Layer I, II, DVD-LPCM
.rm1 .rmvb1	Video	RV30, RV40
	Audio	Realaudio6 (cook), AAC LC, HE-AAC

1 Mamlakatga bog'liq

Video qo'yish bo'yicha ogohlantirishlar

(Faqat UHD modellari)

- ULTRA HD Video: 3840 x 2160, 4096 x 2160
- LG Electronics tomonidan rasmiy taqdim etilmagan kontentdan boshqa ayrim HEVC bilan shifrlangan ULTRA HD videolar ko'rsatmasligi mumkin.
- Dastur yangilangandan so'ng ayrim kodeklar qo'llab-quvvatlanishi mumkin.

Kengaytma	Kodek	
.mkv .mp4 .ts	Video	H.264/AVC, HEVC
	Audio	Dolby Digital, Dolby Digital Plus, AAC

Qo'llab-quvvatlanadigan tashqi subtitrlar

Subtitr	Format
Tashqi subtitr	*.smi, *.srt, *.sub (MicroDVD, SubViewer 1.0/2.0), *.ass, *.ssa, *.txt (TMPPlayer), *.psb (PowerDivX), *.dcs (DLP Cinema)
Bog'langan subtitr	Matroska (mkv): Sub Station Alpha(SSA), Qo'shimcha Sub Station Alpha(ASS), SRT MP4: Vaqtli matn

Ochiq manba dasturi eslatmasi

GPL, LGPL, MPL va ushbu mahsulotda mavjud bo'lgan boshqa ochiq kod litsenziyalari ostida manba kodini olish uchun <https://opensource.lge.com> saytiga tashrif buyuring. Ochiq turdagi kodlarga qo'shimcha ravishda barcha tegishli litsenziya shartlari, kafolatlarning rad qilinishlari va mualliflik huquqlari to'g'risidagi bildirishnomalarni ham yuklab olish mumkin.

LG Electronics opensource@lge.com manziliga so'rov yuborilgan hollarda bunday yetkazib berish xarajatlarini (jumladan, media, jo'natish va qayta ishlash xarajatlari) qoplovchi to'lov evaziga CD-ROM orqali ham ochiq turdagi kodni yetkazib beradi.

Bu taklif mahsulotni yetkazib berilgandan so'ng uch yil ichida amal qiladi. Bu taklif ushbu ma'lumotni olgan har kim uchun amal qiladi.

Dasturiy ta'minotni yuklab olish ma'lumoti

(Faqat UT64*)

- SuperSign dasturiy ta'minot va qo'llanmasi
 - LG Electronics veb-saytiga (<http://partner.lge.com>) tashrif buyuring va modelingiz uchun so'nggi dasturiy ta'minotni yuklab oling.

Litsenziyalar

Qo'shimcha litsenziyalar rusumga qarab farq qilishi mumkin.



The terms HDMI and HDMI High-Definition Multimedia Interface, and the HDMI Logo are trademarks or registered trademarks of HDMI Licensing Administrator, Inc. in the United States and other countries.

DTS patentlari haqida ma'lumot: <http://patents.dts.com>. DTS Licensing Limited litsenziyasi ostida ishlab chiqarilgan. DTS, simvol, & DTS va simvol birga, DTS 2.0 Channel, DTS 2.0+Digital Out, DTS-HD va DTS Virtual:X yozuvlari AQSH yoki boshqa davlatlarda DTS, Inc. kompaniyasining ro'yxatga olingan savdo belgilari yoki savdo belgilaridir. © DTS, Inc. Barcha huquqlar himoyalangan.

Manufactured under license from Dolby Laboratories. Dolby, Dolby Vision, Dolby Audio, Dolby Atmos, and the double-D symbol are trademarks of Dolby Laboratories.



(Rusumga qarab)





Mahsulotning rusumi va seriya raqami
mahsulotning orqa paneli va yon tomonida
ko'rsatilgan. Xizmat ko'rsatish zarur bo'lgan
holatlar uchun ularni quyida yozib qo'ying.

Rusum _____

Seriya raqami _____



FOYDALANISH BO'YICHA QO'LLANMA

RS-232C























LED TV*











* LG LED TVda LED yoritgichlariga ega bo'lgan LCD ekrandan foydalaniladi.

Iltimos, televizoringizdan foydalanishdan avval ushbu qo'llanmani diqqat bilan o'qib chiqing va undan keyinchalik foydalanish uchun saqlab qo'ying.

IR KODLAR

- Ushbu funksiya barcha rusumlarda ham mavjud bo'lavermaydi.

Kod (O'n oltilik)	Funksiya	Eslatma
08	 (QUVVAT)	Masofadan boshqarish pulti tugmasi (Yoqish/O'chirish)
95	 ENERGY SAVING	Masofadan boshqarish pulti tugmasi
AF	 OLIVE ZOOM *	Masofadan boshqarish pulti tugmasi
0B	 INPUT	Masofadan boshqarish pulti tugmasi
F0	 TV/RAD	Masofadan boshqarish pulti tugmasi
10-19	0-9 raqamli tugmalar Alifbo tugmalari  (BO'SH JOY)	Masofadan boshqarish pulti tugmasi
53	 LIST	Masofadan boshqarish pulti tugmasi
1A	 Q.VIEW	Masofadan boshqarish pulti tugmasi
02	 TV	Masofadan boshqarish pulti tugmasi
03	 RADIO	Masofadan boshqarish pulti tugmasi
7C	 SMART	Masofadan boshqarish pulti tugmasi
B5	 APP	Masofadan boshqarish pulti tugmasi
09	 MUTE	Masofadan boshqarish pulti tugmasi
00	 P PAGE UP	Masofadan boshqarish pulti tugmasi
01	 P PAGE DOWN	Masofadan boshqarish pulti tugmasi
AB	 GUIDE	Masofadan boshqarish pulti tugmasi
0C	 PORTAL	Masofadan boshqarish pulti tugmasi
AA	 INFO	Masofadan boshqarish pulti tugmasi
40		Masofadan boshqarish pulti tugmasi
41		Masofadan boshqarish pulti tugmasi
07		Masofadan boshqarish pulti tugmasi
06		Masofadan boshqarish pulti tugmasi

Kod (O'n oltilik)	Funksiya	Eslatma
44	OK 	Masofadan boshqarish pulti tugmasi
43	SETTINGS	Masofadan boshqarish pulti tugmasi
28	↶ (ORQAGA)	Masofadan boshqarish pulti tugmasi
5B	EXIT	Masofadan boshqarish pulti tugmasi
72		Masofadan boshqarish pulti tugmasi
71		Masofadan boshqarish pulti tugmasi
63		Masofadan boshqarish pulti tugmasi
61		Masofadan boshqarish pulti tugmasi
20	 TEXT	Masofadan boshqarish pulti tugmasi
21	T.OPT(T.Option)	Masofadan boshqarish pulti tugmasi
39	SUBTITLE	Masofadan boshqarish pulti tugmasi
B1		Masofadan boshqarish pulti tugmasi
B0		Masofadan boshqarish pulti tugmasi
BA	 	Masofadan boshqarish pulti tugmasi
8F		Masofadan boshqarish pulti tugmasi
8E		Masofadan boshqarish pulti tugmasi
DC	3D/*	Masofadan boshqarish pulti tugmasi
9F	DATA/*	Masofadan boshqarish pulti tugmasi
91	AD/*	Masofadan boshqarish pulti tugmasi
E8	ALARM/*	Masofadan boshqarish pulti tugmasi

TASHQI BOSHQARISH QURILMASINI O'R NATISH

RS-232C sozlanishi

- Ko'rsatilgan tasvir televizoringizdagidan farqlanishi mumkin. Mahsulot funksiyalarini tashqaridan boshqarish uchun RS-232C (tadrijiy port) kirish uyasini tashqi boshqaruv qurilmasiga (kompyuter yoki A/V boshqaruv tizimi kabi) ulang. Boshqaruv qurilmasi tadrijiy portini mahsulotning orqa panelidagi RS-232C uyasiga ulang.
- RS-232C ulanish kabellari mahsulot bilan birga taqdim etilmaydi.

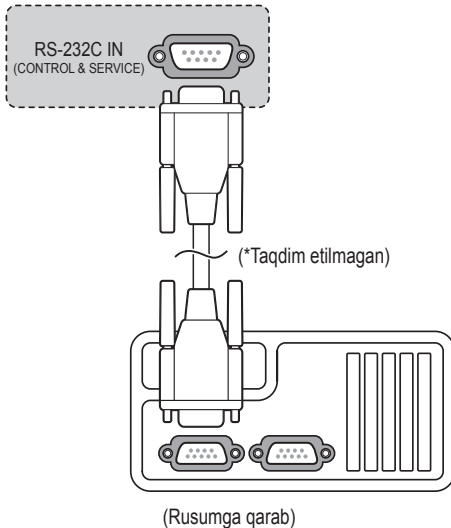

Telefon uyasi turi

(Rusumga qarab)

- ShK va televizorni bir-biriga ulash uchun qo'llanmada ko'rsatilgan telefon uyasiga mos keladigan RS-232C kabelini xarid qilishingiz zarur.
- * Boshqa modellar uchun USB portga ulaning.
- * Ulanish interfeysi televizoringizdagidan farq qilishi mumkin.

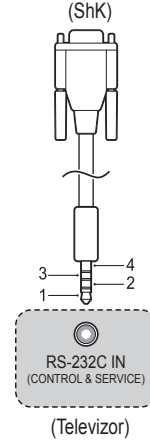

Ulagich turi : D-Sub 9-Pin Male

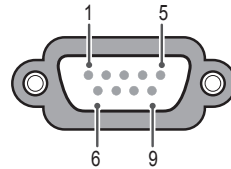

#	Kontakt nomi
1	3,5 V
2	RXD (Ma'lumot olish)
3	TXD (Ma'lumot uzatish)
4	Televizordan chiquvchi IR (Infra qizil)
5	GND
6	Kontakt yo'q
7	Kontakt yo'q (ayrim modellarda 5 V bo'lishi mumkin)
8	Kontakt yo'q
9	Kontakt yo'q (ayrim modellarda 12 V bo'lishi mumkin)

Uzatish / Olish bayonnomasi

(Rusumga qarab)

Uzatish

(Buyruq1)(Buyruq2)([ID-ni o'rnatish])([Ma'lumot])(Cr)

(Buyruq1) : Televizorni boshqarish uchun birinchi buyruq. (j, k, m yoki x)

(Buyruq2) : Televizorni boshqarish uchun ikkinchi buyruq.

([ID-ni o'rnatish]) : Xususiyatlar menyusida kerakli monitor ID'sini tanlash uchun to'plam ID'sini sozlashingiz mumkin. Sozlash diapazoni 1–99. "0"ni to'plam ID'si sifatida tanlayotganda har bir ulangan to'plam boshqariladi. To'plam ID'si menyuda o'nlik (1–99) va uzatish/qabul qilish bayonnomasida O'n oltiilik (0 x 0–0 x 63) ko'rinishda taqdim etiladi.

([Ma'lumot]) : Buyruq ma'lumotlarini uzatish uchun. Buyruq holatini o'qish uchun "FF" ma'lumotini uzatish.

(Cr) : Teskari kareta

ASCII kod "0 x 0D"

() : ASCII kod "bo'shliq (0 x 20)"

OK Ma'lumotnoma

(Buyruq2)([ID-ni o'rnatish])(OK)([Ma'lumot])(x)

* To'plam oddiy ma'lumotni olayotganda bu formatga asosan ACK (ma'lumotnoma)ni uzatadi. Bu gal axborot ma'lumotini o'qish rejimida bo'lsa, u hozirgi holat haqidagi ma'lumotni ko'rsatadi. Agar axborot ma'lumotni yozish rejimida bo'lsa, u shaxsiy kompyuter ma'lumotini qaytaradi.

Xato ma'lumotnoma

(Buyruq2)([ID-ni o'rnatish])(NG)([Ma'lumot])(x)

* To'plam ko'rib bo'lmaydigan funksiyalar yoki aloqa xatoliklaridan noodiaty ma'lumotlarni qabul qilayotganda ushbu format asosida ACK (ma'lumotnoma)ni uzatadi.

[Ma'lumot] 00 : Mumkin bo'lmagan kod

1 Quvvat (Buyruq: k a)

► To'plam Yoqish/O'chirish funksiyasini boshqarish uchun.

Uzatish

(k)(a)([ID-ni o'rnatish])([Ma'lumot])(Cr)

[Ma'lumot] 00 : [O'ch]

[Ma'lumot] 01 : [Yoq]

Ma'lumotnoma

(a)([ID-ni o'rnatish])(OK/NG)([Ma'lumot])(x)

► Televizor ko'rsatishini Yoqish/O'chirish.

Uzatish

(k)(a)([ID-ni o'rnatish])(FF)(Cr)

Ma'lumotnoma

(a)([ID-ni o'rnatish])(OK/NG)([Ma'lumot])(x)

* Oddiygina, boshqa funksiyalar bu format asosida "0 x FF" ma'lumotini uzatlsa, Ma'lumotnoma axborot mulohazasi har bir funksiya bo'yicha holatni aks ettiradi.

* Televizor yoqilgan vaqtda OK ma'lumotnomasi, Xato ma'lumotnomasi va boshqa xabar ekranda ko'rsatilishi mumkin.

2 [Nisbat koeffitsiyenti] (Buyruq: k c) (Asosiy tasvir o'lchami)

► Ekran formatini sozlash uchun. (Asosiy tasvir formati) Tasvir sozlamalari yordamida ekran formatini ham sozlashingiz mumkin.

Uzatish

(k)(c)([ID-ni o'rnatish])([Ma'lumot])(Cr)

[Ma'lumot] 01 : [4:3] (Normal ekran – [Faqat qidirish] O'chirilgan)

[Ma'lumot] 02 : [16:9] (Keng ekran – [Faqat qidirish] O'chirilgan)

[Ma'lumot] 06 : [As] ([Faqat qidirish] O'chirilgan)

[Ma'lumot] 09 : [Faqat qidirish]

* Model Vertikal masshtab o'zgartirish va Har tomonlama masshtab o'zgartirish rejimini qo'llab-quvvatlamasligini tekshiring.

Ma'lumotnoma

(c)([ID-ni o'rnatish])(OK/NG)([Ma'lumot])(x)

* ShK kiritishi yordamida 16:9 yoki 4:3 ekran nisbatini tanlaysiz.

3 Ekran ovozi o'chirish (Buyruq: k d)

- ▶ Ekran ovozi yoqish/o'chirishni tanlash uchun.

Uzatish

(k)(d)()([ID-ni o'matish])()([Ma'lumot])(Cr)

[Ma'lumot] 00 : Ekran ovozi yoqish (Tasvir yoqilgan) / Video ovozi yoqish

[Ma'lumot] 01 : Ekran ovozi o'chirish (Tasvir o'chirilgan)

[Ma'lumot] 10 : Video ovozi o'chirish

Ma'lumotnoma

(d)()([ID-ni o'matish])()(OK/NG)([Ma'lumot])(x)

- * Faqat video ovozi o'chirilgan vaqtda televizor Ekran displeyni (OSD) namoyish qiladi. Lekin Ekran ovozi o'chirilgan bo'lsa, televizor OSD'ni namoyish qilmaydi.

4 Ovozni o'chirish (Buyruq: k e)

- ▶ Ovozni yoqish/o'chirishni boshqarish uchun. Masofadan boshqarish pultidagi ovozi o'chirish tugmasi yordamida ovozi o'chirish funksiyasini sozlashingiz mumkin.

Uzatish

(k)(e)()([ID-ni o'matish])()([Ma'lumot])(Cr)

[Ma'lumot] 00 : Ovozni o'chirish yoqilgan (Ovoz o'chirilgan)

[Ma'lumot] 01 : Ovozni o'chirish o'chirilgan (Ovoz yoqilgan)

Ma'lumotnoma

(e)()([ID-ni o'matish])()(OK/NG)([Ma'lumot])(x)

5 Ovozni boshqarish (Buyruq: k f)

- ▶ Ovozni sozlash uchun. Masofadan boshqarish pultidagi ovoz balandligi tugmalari yordamida ovozi sozlashingiz mumkin.

Uzatish

(k)(f)()([ID-ni o'matish])()([Ma'lumot])(Cr)

[Ma'lumot] Min : 00–Maks : 64

- * "Haqiqiy ma'lumotni joylashtirish"ga qarang.

Ma'lumotnoma

(f)()([ID-ni o'matish])()(OK/NG)([Ma'lumot])(x)

6 [Kontrast] (Buyruq: k g)

- ▶ Ekran kontrastini sozlash uchun. Tasvir sozlamalarida kontrastni sozlashingiz mumkin.

Uzatish

(k)(g)()([ID-ni o'matish])()([Ma'lumot])(Cr)

Ma'lumot Min : 00–Maks : 64

- * "Haqiqiy ma'lumotni joylashtirish"ga qarang.

Ma'lumotnoma

(g)()([ID-ni o'matish])()(OK/NG)([Ma'lumot])(x)

7 [Ravshanlik] (Buyruq: k h)

- ▶ Ekran yorqinligini sozlash uchun. Tasvir sozlamalarida yorqinlikni sozlashingiz mumkin.

Uzatish

(k)(h)()([ID-ni o'matish])()([Ma'lumot])(Cr)

Ma'lumot Min : 00–Maks : 64

- * "Haqiqiy ma'lumotni joylashtirish"ga qarang.

Ma'lumotnoma

(h)()([ID-ni o'matish])()(OK/NG)([Ma'lumot])(x)

8 [Rang] (Buyruq: k i)

- ▶ Ekran rangini sozlash uchun. Tasvir sozlamalarida rangni sozlashingiz mumkin.

Uzatish

(k)(i)()([ID-ni o'matish])()([Ma'lumot])(Cr)

[Ma'lumot] Min : 00–Maks : 64

- * "Haqiqiy ma'lumotni joylashtirish"ga qarang.

Ma'lumotnoma

(i)()([ID-ni o'matish])()(OK/NG)([Ma'lumot])(x)

9 [Ton] (Buyruq: k j)

- ▶ Ekran tusini sozlash uchun.
Tasvir sozlamalarida tusni sozlashingiz mumkin.

Uzatish

(k)(j)()([ID-ni o'rnatish])()([Ma'lumot])(Cr)

[Ma'lumot] Qizil : 00–Yashil : 64

* “Haqiqiy ma'lumotni joylashtirish”ga qarang.

Ma'lumotnoma

(j)()([ID-ni o'rnatish])()([OK/NG])([Ma'lumot])(x)

10 [Aniqlik] (Buyruq: k k)

- ▶ Ekran aniqligini sozlash uchun.
Tasvir sozlamalarida aniqlikni sozlashingiz mumkin.

Uzatish

(k)(k)()([ID-ni o'rnatish])()([Ma'lumot])(Cr)

[Ma'lumot] Min : 00–Maks : 32

* “Haqiqiy ma'lumotni joylashtirish”ga qarang.

Ma'lumotnoma

(k)()([ID-ni o'rnatish])()([OK/NG])([Ma'lumot])(x)

11 OSD tanlash (Buyruq: k l)

- ▶ Masofadan boshqarayotganda OSD'ni (On Screen Display) yoqish/o'chirishni tanlash uchun.

Uzatish

(k)(l)()([ID-ni o'rnatish])()([Ma'lumot])(Cr)

[Ma'lumot] 00 : [O'ch]

[Ma'lumot] 01 : [Yoq]

Ma'lumotnoma

(l)()([ID-ni o'rnatish])()([OK/NG])([Ma'lumot])(x)

12 Masofadan boshqarish pultini bloklash rejimi

(Buyruq: k m)

- ▶ Monitor va masofadan boshqarish pultida old panel boshqaruv elementlarni qulflash uchun.

Uzatish

(k)(m)()([ID-ni o'rnatish])()([Ma'lumot])(Cr)

[Ma'lumot] 00 : [O'ch]

[Ma'lumot] 01 : [Yoq]

Ma'lumotnoma

(m)()([ID-ni o'rnatish])()([OK/NG])([Ma'lumot])(x)

* Masofadan boshqarish pultidan foydalanmayotgan bo'lsangiz, bu rejimdan foydalaning. Asosiy quvvat yoqilgan o'chirilganda tashqi boshqaruv qulfi qo'yib yuboriladi.

* Kutish rejimida agar tugma bloklanishi yoqilgan bo'lsa, TV IR (infraqizil) va Mahalliy tugmasini yoqadi.

13 [Balans] (Buyruq: k t)

- ▶ Balansni sozlash uchun.
Audio sozlamalarida balansni sozlashingiz mumkin.

Uzatish

(k)(t)()([ID-ni o'rnatish])()([Ma'lumot])(Cr)

[Ma'lumot] Ch : 00–O' : 64

* “Haqiqiy ma'lumotni joylashtirish”ga qarang.

Ma'lumotnoma

(t)()([ID-ni o'rnatish])()([OK/NG])([Ma'lumot])(x)

14 [Rang harorati] (Buyruq: x u)

- ▶ Rang haroratini sozlash uchun. Tasvir sozlamalarida Rang haroratini sozlashingiz mumkin.

Uzatish

(x)(u)()([ID-ni o'rnatish])()([Ma'lumot])(Cr)

[Ma'lumot] Iliq: 00–Sovuq:64

* “Haqiqiy ma'lumotni joylashtirish”ga qarang.

Ma'lumotnoma

(u)()([ID-ni o'rnatish])()([OK/NG])([Ma'lumot])(x)

15 [Quvvat tejash] (Buyruq: j q)

- ▶ Televizor quvvat sarfini kamaytirish uchun. Tasvir sozlamalarida Quvvat tejashni sozlashingiz mumkin.

Uzatish

(j)(q)()([ID-ni o'matish])()([Ma'lumot])(Cr)

Quvvat tejash rejimi					Daraja				Tavsif
7	6	5	4		3	2	1	0	
0	0	0	0	Past quvvat	0	0	0	0	[O'ch]
0	0	0	0	Past quvvat	0	0	0	1	[Minimum]
0	0	0	0	Past quvvat	0	0	1	0	[O'rtacha]
0	0	0	0	Past quvvat	0	0	1	1	[Maksimum]
0	0	0	0	Past quvvat	0	1	0	1	[Ekran o'chirilgan]
0	0	0	0	Past quvvat	0	1	0	0	[Avtomatik]

- ▶ "Aqlli sensor"ni qo'llab-quvvatlovchi TVda [Avtomatik] funksiyasidan foydalanish mumkin.

Ma'lumotnoma

(q)()([ID-ni o'matish])()OK/NG)([Ma'lumot])(x)

16 [Avtomatik sozlash] (Buyruq: j u) (Faqat RGB qo'llab-quvvatlovchi model)

- ▶ Tasvir holatini sozlash va tasvir titrashini avtomatik tarzda minimalashtirish uchun. U faqat RGB (ShK) rejimida ishlaydi.

Uzatish

(j)(u)()([ID-ni o'matish])()([Ma'lumot])(Cr)

[Ma'lumot] 01 : O'matish uchun

Ma'lumotnoma

(u)()([ID-ni o'matish])()OK/NG)([Ma'lumot])(x)

17 [Ekvalayzer] (Buyruq : j v)

- ▶ Ekvalayzerni sozlash uchun.

Uzatish

(j)(v)()([ID-ni o'matish])()([Ma'lumot])(Cr)

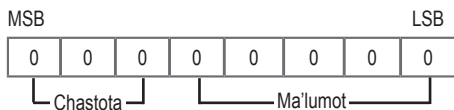

7	6	5	Chastota	4	3	2	1	0	Bosqich
0	0	0	1-tasma	0	0	0	0	0	0 (o'nlik)
0	0	1	2-tasma	0	0	0	0	1	1 (o'nlik)
0	1	0	3-tasma
0	1	1	4-tasma	1	0	0	1	1	19 (o'nlik)
1	0	0	5-tasma	1	0	1	0	0	20 (o'nlik)

Ma'lumotnoma

(v)()([ID-ni o'matish])()OK/NG)([Ma'lumot])(x)

18 Sozlash buyrug'i (Buyruq: m a)

- Quyidagi haqiqiy raqamdan keyin kanal tanlang.

Uzatish

(m)(a)()([ID-ni o'rnatish])()([Ma'lumot] 00)()([Ma'lumot] 01)()
([Ma'lumot] 02)(Cr)

[Ma'lumot] 00 : Yuqori kanal ma'lumoti

[Ma'lumot] 01 : Quyi kanal ma'lumoti
masalan. # 47 → 00 2F (2FH)
394 → 01 8A (18AH),
DTV # 0 → Farqi yo'q

[Ma'lumot] 02 : (Antenna)

0 x 00 : Analogli Asosiy
0 x 10 : DTV Asosiy
0 x 20 : Radio
(Kabel)
0 x 80 : Analogli Asosiy
0 x 90 : DTV Asosiy
0 x A0 : Radio
(Sun'iy yo'ldosh)
0 x 40 : DTV Asosiy
0 x 50 : Radio Asosiy

Kanal ma'lumot diapazoni

Min : 00 Maks : 270F (0–9999)

Ma'lumotnoma

(a)()([ID-ni o'rnatish])()OK/NG)([Ma'lumot])(x)

19 Dastur [O'tkazib yuborish] / [Qo'shmoq] (Buyruq: m b)

- Joriy Dastur uchun o'tkazish statusini o'rnatish uchun.

Uzatish

(m)(b)()([ID-ni o'rnatish])()([Ma'lumot])(Cr)

[Ma'lumot] 00 : [O'tkazib yuborish]

[Ma'lumot] 01 : [Qo'shmoq]

Ma'lumotnoma

(b)()([ID-ni o'rnatish])()OK/NG)([Ma'lumot])(x)

20 Tugma (Buyruq: m c)

- IR (infraqizil) masofadan boshqarish kaliti kodi.

Uzatish

(m)(c)()([ID-ni o'rnatish])()([Ma'lumot])(Cr)

[Ma'lumot] IR KODLAR

Ma'lumotnoma

(c)()([ID-ni o'rnatish])()OK/NG)([Ma'lumot])(x)

21 [Fon chirog'i] ni boshqarish (Buyruq: m g)

- Orqa chiroqni boshqarish uchun.

Uzatish

(m)(g)()([ID-ni o'rnatish])()([Ma'lumot])(Cr)

[Ma'lumot] Min : 00–Maks : 64

Ma'lumotnoma

(g)()([ID-ni o'rnatish])()OK/NG)([Ma'lumot])(x)

22 [Kiritish] ni tanlash (Buyruq: x b) (Asosiy tasvir kirishi)

► Asosiy tasvir kirish manbaini tanlash uchun.

Uzatish

(x)(b)()([ID-ni o'rnatish])()([Ma'lumot])(Cr)

[Ma'lumot] Tuzilma

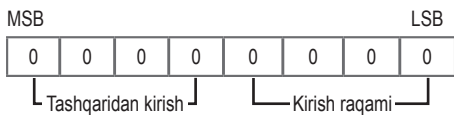

Tashqaridan kirish				Ma'lumot
0	0	0	0	[DTV]
0	0	0	1	[Analogli]
0	0	1	0	[AV]
0	1	0	0	[Tarkibiy qism]
0	1	1	0	[RGB]
0	1	1	1	[HDMI]
1	0	0	0	
1	0	0	1	
1	0	1	0	

Kirish raqami				Ma'lumot
0	0	0	0	Kiritish1
0	0	0	1	Kiritish2
0	0	1	0	Kiritish3
0	0	1	1	Kiritish4

Ma'lumothoma

(b)()([ID-ni o'rnatish])(OK/NG)([Ma'lumot])(x)

*** Haqiqiy ma'lumotni joylashtirish**

00 :	0-qadam
⋮	
A :	10-qadam ([ID-ni o'rnatish] 10)
⋮	
F :	15-qadam ([ID-ni o'rnatish] 15)
10 :	16-qadam ([ID-ni o'rnatish] 16)
⋮	
64 :	100-qadam
⋮	
6E :	110-qadam
⋮	
73 :	115-qadam
74 :	116-qadam
⋮	
CF :	199-qadam
⋮	
FE :	254-qadam
FF :	255-qadam



Mahsulotning rusumi va seriya raqami
mahsulotning orqa paneli va yon tomonida
ko'rsatilgan. Xizmat ko'rsatish zarur bo'lgan
holatlar uchun ularni quyida yozib qo'ying.

Rusum _____

Seriya raqami _____