

OWNER'S & INSTALLATION MANUAL

AIR CONDITIONER

Please read this installation manual completely before installing the product. Installation work must be performed in accordance with the national wiring standards by authorized personnel only. This equipment shall be provided with a supply conductor complying with the national regulation.

PDI (PDI Premium)
PQNUD1S40
Original instructions

Factory : LG Electronics Inc. Changwon 2nd factory, 84,
Wanam-ro, Seongsan-gu, Changwon-si, Gyeongsangnam-do, KOREA
UK Importer : LG Electronics U.K. Ltd, Velocity 2, Brooklands Drive, Weybridge, KT13 0SL



MFL69157015
Rev.07_081924

Copyright © 2018 - 2024 LG Electronics Inc. All Rights Reserved.



www.lg.com

SLOVENČINA
PORTUGUÊS
ENGLISH

SLOVENŠČINA
MAGYAR
ITALIANO

LATVIŠŅU VALODA
БЪЛГАРСКИ
ESPAÑOL

LIETUVŲ KALBA
SRPSKI
FRANÇAIS

GAELIGE
HRVATSKI
DEUTSCH

МАКЕДОНСКИ
SVENSKA
EVAHNIKA

SHQIP
NORSK
ČEŠTINA

BOSANSKI
DANSK
NEDERLANDS

العربية
EESTI KEEL
POLSKI

MALTI
LIMBA ROMÂNĂ

IMPORTANT SAFETY INSTRUCTIONS (Only Australia)

READ ALL INSTRUCTIONS BEFORE USING THE APPLIANCE.

Always comply with the following precautions to avoid dangerous situations and ensure peak performance of your product.

- This appliance is not intended for use by persons (including children) with reduced physical, sensory or mental capabilities, or lack of experience and knowledge, unless they have been given supervision or instruction concerning use of the appliance by a person responsible for their safety.
- Children should be supervised to ensure that they do not play with the appliance.
- For connections and wiring to the external control devices and the supply cord, refer to the wiring diagram in the service manual.
- For more information on the following, refer to the installation manual:
 - The method of connection of the appliance to the electrical supply and interconnection of separate components;
 - dimensions of the space to be provided for the appliance;
 - dimensions and position of the means for supporting and fixing the appliance within this space;
 - minimum distances between the various parts of the appliance and the surrounding structure;
 - how the appliance is to be fixed to its support.
- If the supply cord is damaged, it must be replaced by the manufacturer, its service agent or similarly qualified persons in order to avoid a hazard.
- The appliance shall be installed in accordance with the national wiring regulation.
- Details of fuses as below:

Rating	Type
125 V / 1 A	Non Time Delay Fuse, 0451001MRL CERAMIC 125V 1A UL SMD TP LITTELFUSE INC

SAFETY INSTRUCTIONS

The following safety guidelines are intended to prevent unforeseen risks or damage from unsafe or incorrect operation of the appliance.

The guidelines are separated into 'WARNING' and 'CAUTION' as described below.

 This symbol is displayed to indicate matters and operations that can cause risk.
Read the part with this symbol carefully and follow the instructions in order to avoid risk.

WARNING

This indicates that the failure to follow the instructions can cause serious injury or death.

CAUTION

This indicates that the failure to follow the instructions can cause the minor injury or damage to the product.

WARNING

Installation

- To reinstall the product, please contact the dealer from where you purchased the product, or a service center for reinstallation service.
 - Installation of the product by an unauthorized person may result in fire, electric shock, explosion, injury, or a malfunctioning of the product.
- Do not twist or damage the power cord.
 - It may cause fire or electric shock.
- For electrical work, please contact the dealer from where you purchased the product, or a service center.
 - Disassembly or repair by an unauthorized person may result in fire or electric shock.
- Install the product in an area shielded from rain.
 - If water gets into the product, it may malfunction.
- Do not install the product in a humid area.
 - If the product is damp, it may malfunction.

- For installation of the product, please contact the dealer from where you purchased the product, or a service center.
 - Installation of the product by an unauthorized person may result in fire, electric shock, explosion, injury, or a malfunctioning of the product.
- For electrical work, please have an electrician do the work based on the installation manual and specified circuit diagram.
 - Using an unsuitable cord, or having a non-professional work on the electricals may result in fire or electrical shock.
- Do not place the product near a fire source.
 - It may result in the product catching fire.
- If the product is installed in a hospital or a communication base station, provide sufficient protective equipment against electrical noise.
 - The product may malfunction or other products may work abnormally.
- Securely install the product.
 - If the product is not secured during installation, it may fall or malfunction.
- Read the manual thoroughly to correctly install the product.
 - If not, an incorrect installation may cause fire or electric shock.
- When wiring the product, do not use a non-standard cable, nor extend the cable excessively.
 - It may cause a fire or electric shock.
- Securely install the power cord and communication cable.
 - An unsecure installation may result in a fire or electric shock.
- Do not connect the power cord to the communication terminal.
 - It may cause a fire, electric shock, or a product malfunction.
- Do not install the product in an area near combustible gas.
 - It may result in fire, electric shock, explosion, injury, or a malfunctioning of the product.
- Always ground the product.
 - There is risk of fire or electric shock.

Operation

- Do not place a heavy object on the power cord.
 - It may cause a fire or electric shock.
- Do not change or extend the power cord arbitrarily.
 - It may cause a fire or electric shock.

- Use the cord specific to the product.
 - Using an unauthorized non-standard cord may result in a fire or electric shock.
- Do not use a heat device near the power cord.
 - It may cause a fire or electric shock.
- Ensure that water never gets into the product.
 - It can result in an electric shock, or the product may malfunction.
- Do not place any container with liquid on the product.
 - The product may malfunction.
- Do not touch the product with wet hands.
 - It may cause a fire or electric shock.
- Use standard components.
 - Use of an unauthorized product may result in fire, electric shock, explosion, injury, or a malfunctioning of the product.
- If the product has been submerged in water, you should contact a service center.
 - It may cause a fire or electric shock.
- Do not shock the product.
 - The product may malfunction.
- Do not store or use any combustible gas or flammable substances near the product.
 - It may cause a fire, or a product malfunction.
- Do not disassemble, repair, or revamp the product arbitrarily.
 - It may cause a fire or electric shock.
- Children and the elderly should use the product under the supervision of a guardian.
 - Carelessness may cause an accident, or the product to malfunction.
- The guardian should prevent children from accessing the product.
 - The product may be damaged or it may fall, causing injury to children.
- Keep in mind the operating temperature range specified in the manual. if there is no operating temperature range in the manual, use the product between 0 °C ~ 40 °C (32 °F ~ 104 °F).
 - If the product is used outside this range, the product may be severely damaged.
- Do not press the switch or button with a sharp object.
 - It can result in an electric shock, or the product may malfunction.
- Do not wire the product while it is turned on.
 - It may cause a fire or electric shock.

- If the product sounds or smells different, stop using the product.
 - It may cause a fire or electric shock.
- Do not place a heavy object on the product.
 - The product may malfunction.
- Do not spray water on the product, or clean it with a water-soaked cloth.
 - It may cause a fire or electric shock.
- Do not use the product for the preservation of animals and plants, precision instruments, art pieces, or for other special purposes.
 - It may cause property damage.
- Dispose the packing material safely.
 - The packing material may result in personal injuries.

CAUTION

Installation

- Securely install the product in an area where the weight of the product can be supported.
 - The product may fall and be destroyed.
- Do not use the product where there is oil, steam, or sulfuric gas.
 - It may effect the product's performance, or damage it.
- Check the rated power capacity.
 - It may cause a fire, or a product malfunction.
- Use the adaptor provided with the product or power from a class 2 24 V~ transformer, depending on model.
 - If a non-standard adaptor is used, the product may malfunction.
The adaptor is not provided with the PDI package sold in the U.S.
- Be careful not to drop or damage the product when moving it.
 - The product may malfunction or the person may sustain an injury.
- Ensure that the cord is connected securely to prevent dew, water, or insects from getting into the product.
 - If a foreign substance gets inside, it may cause an electric shock or the product may malfunction.
- The appliance is only to be used with the power supply unit provided with the appliance.
- Do not install the unit in potentially explosive atmospheres.

Operation

- Clean the product with a soft cloth, but not with a solvent-based detergent.
 - The use of a solvent-based detergent may cause a fire or deform the product.

- Do not touch the panel using a pointy or sharp object.
 - It can result in an electric shock, or the product may malfunction.
- Do not let the product come into contact with a metal substance.
 - The product may malfunction.
- When sterilizing or disinfecting, stop using the product.
 - The product may work abnormally.
- Do not touch inside the product.
 - The product may malfunction.
- Check the condition of the product after using the product for an extended period of time.
 - If the product is used for an extended period of time, the product's condition may be worsen, causing injury to the user.
- Do not leave the product near a flower base, water bottle, or any other liquids.
 - It may cause a fire or electric shock.
- If the liquid crystal of the product is broken, please do not let your skin such as face or hands contact with.
 - Personal injury or property damage may occur.
- If the supply cord is damaged, it must be replaced by the manufacturer, its service agent or similarly qualified persons in order to avoid a hazard.
- Appliance shall be disconnected from its power source during service and when replacing parts.

According to IEC 60335-1

This appliance is not intended for use by person (including children) with reduced physical, or mental capabilities, or lack of experience and knowledge, unless they have been given supervision or instruction concerning use of the appliance by a person responsible for their safety. Children should be supervised to ensure that they do not play with the appliance.

According to EN 60335-1

This appliance can be used by children aged from 8 years and above and person with reduced physical, sensory or mental capabilities or lack of experience and knowledge if they have been given supervision or instruction concerning use of the appliance in a safe way and understand the hazards involved. Children shall not play with the appliance. Cleaning and user maintenance shall not be made by children without supervision.

⚠ CAUTION

Changes or modifications not expressly approved by the manufacturer responsible for compliance could void the user's authority to operate the equipment.

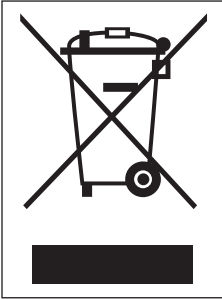

Disposal of your old appliance

1. This crossed-out wheeled bin symbol indicates that waste electrical and electronic products (WEEE) should be disposed of separately from the municipal waste stream.
2. Old electrical products can contain hazardous substances so correct disposal of your old appliance will help prevent potential negative consequences for the environment and human health. Your old appliance may contain reusable parts that could be used to repair other products, and other valuable materials that can be recycled to conserve limited resources.
3. You can take your appliance either to the shop where you purchased the product, or contact your local government waste office for details of your nearest authorised WEEE collection point. For the most up to date information for your country please see www.lg.com/global/recycling



Disposal of your old appliance (as per e-waste Rules)

1. When this crossed out wheeled bin symbol is depicted on the product and its operator's manual, it means the product is covered by the e-waste Management and Handling Rules, 2011 and are meant to be recycled, dismantled, refurbished or disposed off.

2. Dos

- a. The product is required to be handed over only to the authorized recycler for disposal.
- b. Keep the product in isolated area, after it becomes non-functional/unrepairable so as to prevent its accidental breakage.

Don't

- a. The product should not be opened by the user himself/herself, but only by authorized service personnel.
 - b. The product is not meant for re-sale to any unauthorized agencies/scrap dealer/kabariwala.
 - c. The product is not meant for mixing into household waste stream.
 - d. Do not keep any replaced spare part(s) from the product in exposed area.
3. Any disposal through unauthorized agencies/person will attract action under Environment (Protection) Act 1986.
 4. Hazards of improper handling or accidental breakage.
 - a. If batteries are disposed incorrectly, it can greatly harm the environment. The chemical byproducts are hazardous. The metals and chemicals found in batteries can mix into soil which may be hazardous to humans, plants and animals. If thrown in fire, they can cause blast and release toxic gases which may be harmful for health.
 - b. The refrigerant used can be combustible at low pressure. The potential health effect of over exposure is dizziness, headache and heart irregularities.
 5. This product is complied with the requirement of Hazardous Substances as specified under Rule 13 (1) & (2) of the E-Waste (Management & Handling) Rules, 2011.
 6. To locate a nearest collection centre or call for pick-up (limited area only) for disposal of this appliance, please contact Toll Free No. 1800-180-3575 for details. All collection centre and pick up facilities are done by third parties with LG Electronics India Pvt. Ltd. Merely as a facilitator. For more detailed information, please visit : <http://www.lge.com/in>

※ The above information applies only to India.

अपन पुराने निपटान के उपकरण (ई-अपशिष्ट नियम के अनुसार)

1. जब इस कारे गए पहिले वाले बिन का चिन्ह किसी उपकरण और इसके ओपरेटर की पुस्तिका के साथ संलग्न होता है तो इसका मतलब है कि इसे "ई-अपशिष्ट" (प्रबंधन और इधारन) नियम २०११ के अंतर्गत सम्मिलित किया गया है, और इस नवीनीकरणकरण, विपटन और निपटान के लिए बनाया गया है।

३. करें

- क. उपकरण को सिर्फ अधिकृत पुनः नवीनीकरणकर्ता को ही निपटार करने हेतु हस्तान्तरित करें।
- ख. जब उपकरण कार्यरत न हो इसे अलग क्षेत्र में रखें ताकि उपकरण से होने वाली दुर्घटनाओं से बचा जा सके।

न करें

- क. इस उपकरण को स्वयं/खुद नहीं खोलना चाहिए। उपकरण को केवल अधिकृत अधिकारी के द्वारा ही खोला जाना चाहिए।
- ख. इस उपकरण को पुनः बिक्री के लिए किसी भी कबाडीवाला / भंगार-वाला / अनाधिकृत संस्था को न दें।
- ग. इस उपकरण को किसी परेजु अपशिष्ट सामान के साथ मिलाकर न रखें।

- घ. उपकरण के बदले हुए या आंतरिक पुरजो को खुले क्षेत्र में न रखें।

३. यदि किसी अनाधिकृत विषय या व्यक्ति के द्वारा निपटारन किया जाता है तो यह पर्यावरण (सुरक्षा) धारा १९८६ के अंतर्गत जाता है।

४. दर्पु टना टूट / फूट अव्यवस्थित रख-रखाव से बचें।

- क. यदि बड़े बर्तनों का निपटारन अशुद्ध रूप से कर रहे हैं, तो यह वातावरण को बहुत नुकसान पहुँचा सकता है। पर्यावरणिक उपकरण खतरनाक होते हैं। जो स्वामन और धातु बैटरीयों में पाए जाते हैं। इसे मिट्टी में मिचाने पर यह मनुष्यों, पौधों और पशुओं दस लि ए खतरनाक हो सकती है। यदि इसे आग में के कते हैं तो ये विस्फोट कर सकती है और ये जहलीली गैस दे सकती है जो स्वास थ्य के ए हानिकारक है।
- ख. रेफ्रिजरेट काम दबाव पर दहनशील हो सकती है तथा इससे स्वास थ्य पर दधु प्रभाव पड़ सकता है जैसे चकक द आन, सर दर्द और हृदय गति रुकना।

५. यह उपकरण ई-अपशिष्ट (प्रबंधन और इधारन) नियम 2011 के अन्तर्गत 13(1) एवं (2) के रहत निर्दिष्ट खतरनाक पदार्थों की आवश्यकता का पालन करता है।

६. उपरोक्त पदार्थों के निपटारन के लिए नजदीकी निपटारन संस्थान (संकीर्ण क्षेत्र) में कौन कौन। अधिक जानकारी के लिए हमारे टोल फ्री नंबर 1800-315-9999 / 1800-180-9999 पर कॉल करें. सभी संग्रहण केंद्र व पिक-अप की सुविधाएं किसी थर्ड-पार्टी जो "LG Electronics India Pvt. Ltd." को अपनी सेवाएं प्रदान कर रही हों, से करवाएं। ज्यादा जानकारी के लिए देखें वेबसाइट - <http://www.lge.com/in>

※ उपर दी गई जानकारी केवल भारत पर लागू होती है।

Safely dispose all materials in accordance with federal/state/local laws or ordinances.

التخلص الآمن من كافة المواد بما يتوافق مع القوانين والأوامر المحلية

COMPONENTS

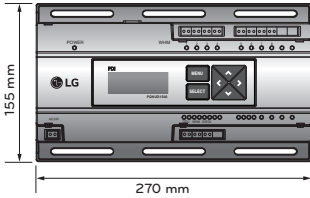

Power distribution indicator

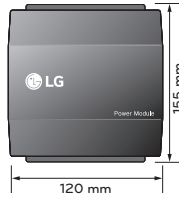

Power supply



Manual

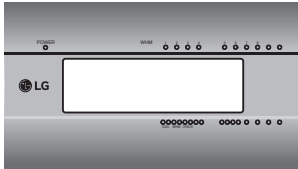

Front cover



Screw

Item	Specification
Protection class	IP20

NAME OF EACH PART

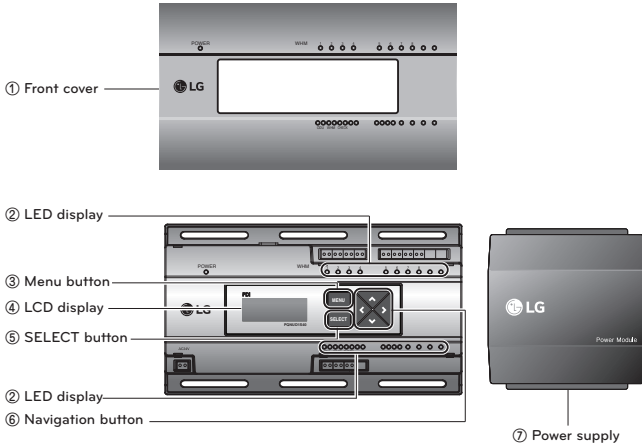

① Front cover

② LED display Displays current status of power indicator

③ Menu button Use for checking initial setting and electric power

④ LCD display Displays setting information and power usage

⑤ SELECT button Use for initial setting

⑥ Navigation button Use for checking initial setting and electric power

⑦ Power supply Supply power for power indicator

INSTALLATION METHOD

Diagram of overall product configuration

When interlocked to pulse type wattmeter

- Interlocked Operation with Central Controller (interlocked to EHP product)

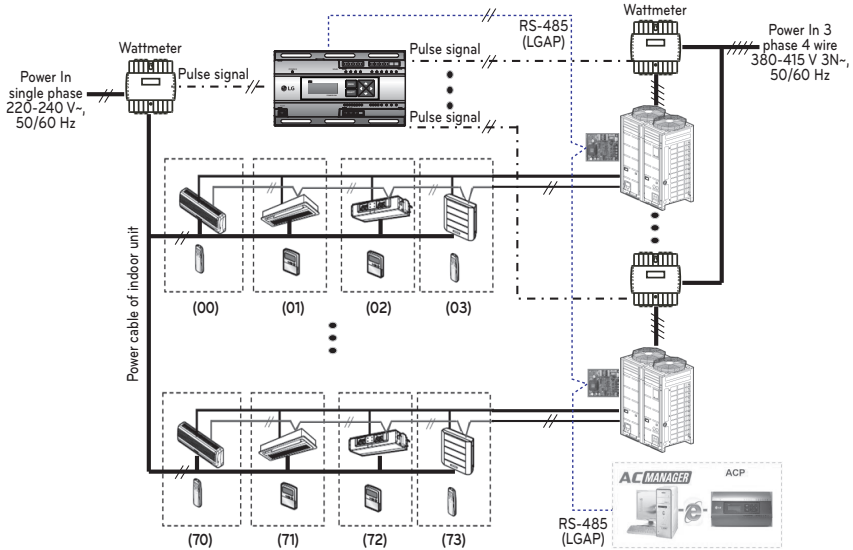

	: Power cable for 3 phase 4 wire
	: Power cable for single phase
	: Communication cable (2 wire shielded cable): Between outdoor unit and central controller
	: Communication cable (2 wire shielded cable): Between indoor unit and outdoor unit
	: Pulse signal wire
	: Refrigerant pipe

CAUTION

- Depending on the electric power, use the wattmeter for remote reading by sending the pulse signal.
- Use the wattmeter with the pulse width of 50 ms ~ 400 ms.
- The wattmeter pulse must be able to sink at least 3 mA or more of current in the power indicator.
- Use the wattmeter of 1 W/Pulse, 2 W/Pulse, 4 W/Pulse, 6 W/Pulse, 8 W/Pulse, 10 W/Pulse, 100 W/Pulse and PT/CT (1 ~ 50 000).
- When setting the wattmeter, set it to Slave Mode.
- Maximum of 8 wattmeters can be installed.
- The distance between power indicator and wattmeter should be shorter than 50 m in normal circumstance.
- When electrical or mechanical noise is expected, more shorter wiring is needed.

* EHP (Electric Heat Pump): It is an electric air conditioner to drive the compressor by electric power.

• When interlocked to GHP product

- When linked with the GHP product, the central controller is linked only possible model of ACS IV series or later.

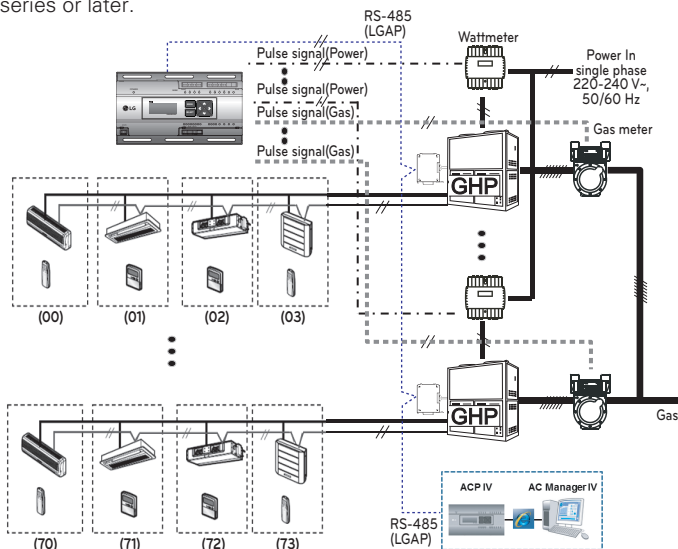

	: Power cable for single phase
	: Communication cable (2 wire shielded cable): Between outdoor unit and central controller
	: Communication cable (2 wire shielded cable): Between indoor unit and outdoor unit
	: Pulse signal wire
	: Refrigerant pipe
	: Gas pipe
	: Pulse signal wire(Gas)

! CAUTION

- Use the wattmeter for remote reading to send pulse signal depending on wattage.
- Use the wattmeter with the pulse width of 50 ms ~ 400 ms.
- The wattmeter pulse must be able to sink at least 3 mA or more of current in the power indicator.
- Use the wattmeter for 1 W/Pulse, 2 W/Pulse, 4 W/Pulse, 6 W/Pulse, 8 W/Pulse, 10 W/Pulse, 100 W/Pulse, PT / CT (1 ~ 50 000).
- Use the gas meter for remote reading to send pulse signal depending on gas consumption.
- Use the gas meter with the pulse width of 50 ms or more.
- Use the gas meter containing the max. gas pressure of 0.2 m³/h ~ 10 m³/h.
- Gas meter pulse must be able to sink at least 3 mA of current or more in the power indicator.
- Use the gas meters for 1 l / Pulse, 2 l / Pulse, 4 l / Pulse, 6 l / Pulse, 8 l / Pulse, 10 l / Pulse, 100 l / Pulse, VT / Pr (1 ~ 50 000).
- Set to Slave Mode when setting the wattmeter or gas meter.
- Wattmeter or gas meter can be installed up to 4.
- Connection cable for the power indicator and wattmeter (gas meter) must not exceed 50 m in normal circumstance.
- Reduce the length of connection cable if there is any electrical or mechanical noise on the site.

* GHP (Gas engine Heat Pump): It is a gas air-conditioner to drive the compressor with LNG or LPG as a heat source and the gas engine electric power.

How to wire the product (when EHP product is connected)

Wiring Power Indicator

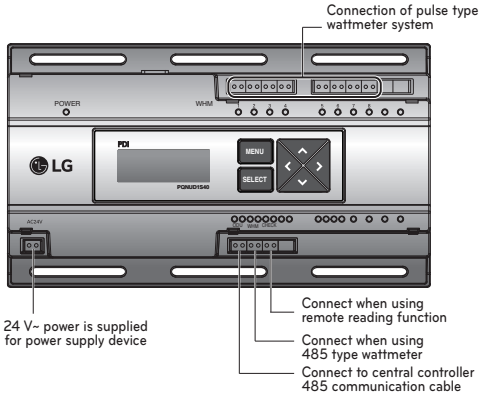

Wiring Power Supply

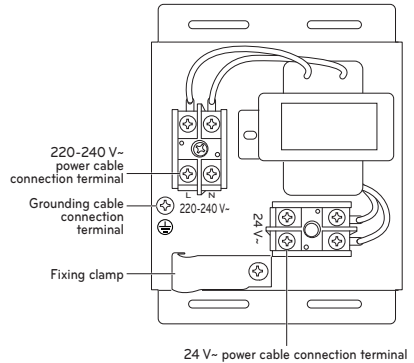

CAUTION

- Power must be turned on after the product is wired completely.

How to wire the product (when GHP product is connected)

Wiring Power Indicator

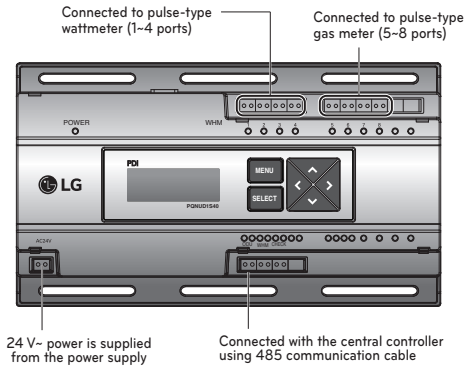

Wiring Power Supply

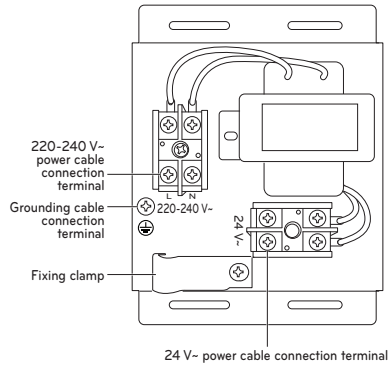

CAUTION

- Power supply must be applied after wiring the product is completed, if applicable.

Wiring

- Separate the power supply case.
- Loosen the clamp fixing the power supply.
- Connect the 220-240 V~ power cable to the black and grounding terminal.
- Connect the 24 V~ power cable to the yellow terminal.
- Use the clamp to fixate the 220-240 V~ and 24 V~ power cable.
- Use the screw to assemble the case.
- Use the included screws to fixate the power indicator and power supply at appropriate locations within the electric panel.
- Connect the 24 V~ power cable connected to the power supply to the power terminal of the power indicator.
- Wire wattmeter, gas meter, central controlled communication cable, and the repeater for remote reading.

Power connection

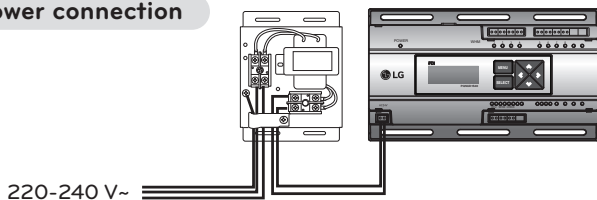

Mounting on wall

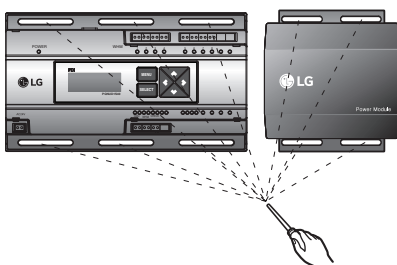

! WARNING

- Always tighten the terminal screws so that they do not become loose.
- When connecting the power and communication cable, always use the terminal (O-Ring, Y-Ring).
- For 220-240 V~ power cable, use (CV) 1.5 mm² x 3 and for 24 V~ power cable, use the CV wire.

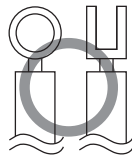

! CAUTION

- Power must be turned on after the product is wired completely.
- When power is removed and then applied again, power on after 2 minutes.

Connect the wattmeter and communication cable (EHP products)

When connecting the pulse-type wattmeter

- Independent Operation of Power Indicator (interlocked to EHP product)

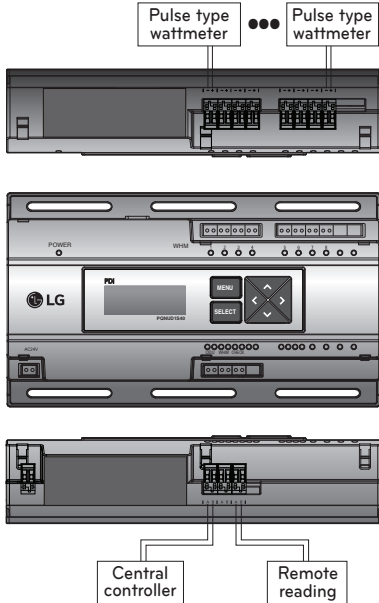

! CAUTION

- The color and polarity of the signal wire may be different from the details indicated on the case depending on the manufacturer of wattmeter. [Black: (-), white: (+)]
- When connecting the 485 communication cable, make sure to check the A, B polarity.
- After connecting the wattmeter, check whether the signal is connected through the LED.
- Power indicator and Pulse Type wattmeter must be installed in same panel.

Connection of wattmeter, gas meter and communication cable (GHP products)

When connecting the pulse-type wattmeter / gas meter

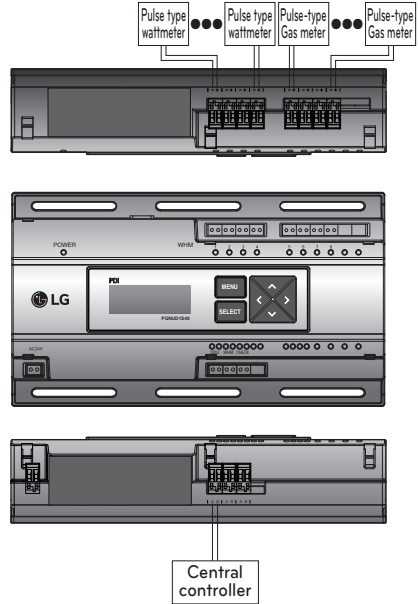

! CAUTION

- The color and polarity of the signal wire may be different from the details indicated on the case depending on the manufacturer of wattmeter. [Black: (-), white: (+)]
- When connecting the 485 communication cable, make sure to check the A, B polarity.
- After connecting the wattmeter, check whether the signal is connected through the LED.
- Install the power indicator and the pulse-type wattmeter on the same panel.
- Make sure that the pulse lines of the wattmeter and gas meter are connected to the correct positions (wattmeter : 1 ~ 4 ports, gas meter : 5 ~ 8 ports)

SETTING AND USING METHOD

Setting up detailed functions (EHP products)

Flowchart for how to set up functions (EHP products)

While EHP product is selected, set the detailed functions of the power indicator with reference to the flowchart below

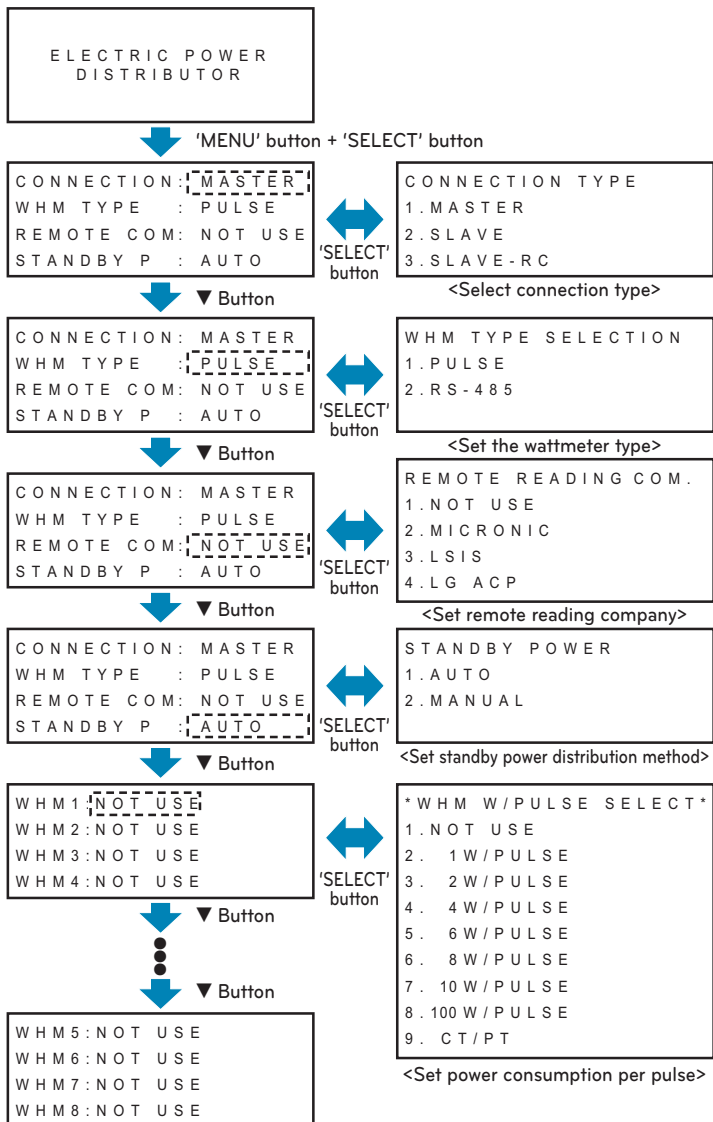

! CAUTION

- Power indicator setting only can be changed during the 20 minutes after turning on the power.
Twenty (20) minutes later, if you need to change settings, turn the power indicator on again.

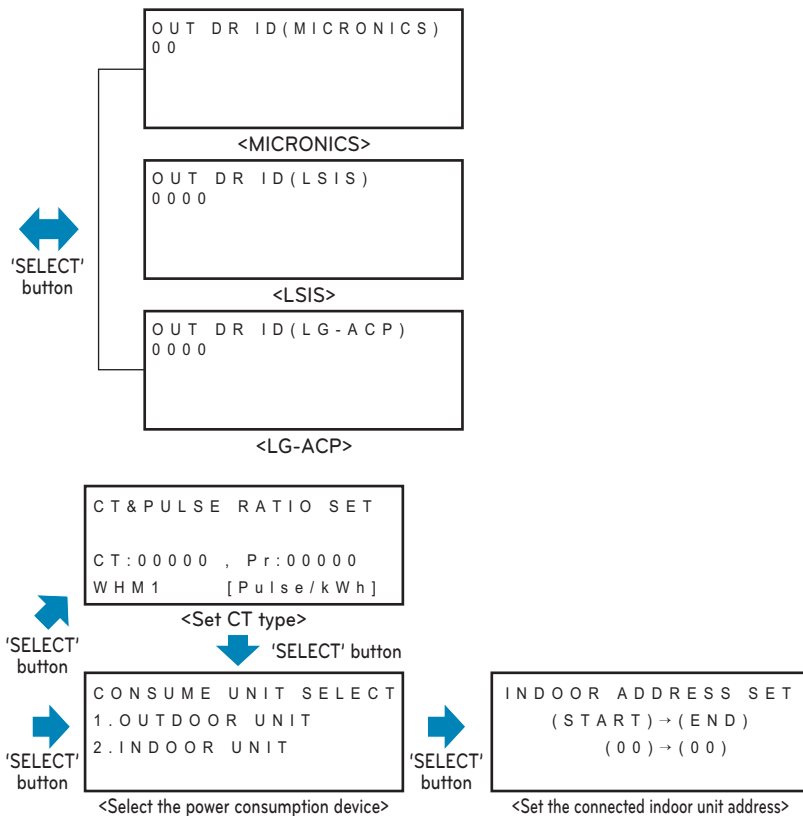

Setting detailed functions (GHP products)

Function Setting Method Flowchart (GHP products)

While GHP product is selected, set the detailed functions of the power indicator with reference to the following flowchart.

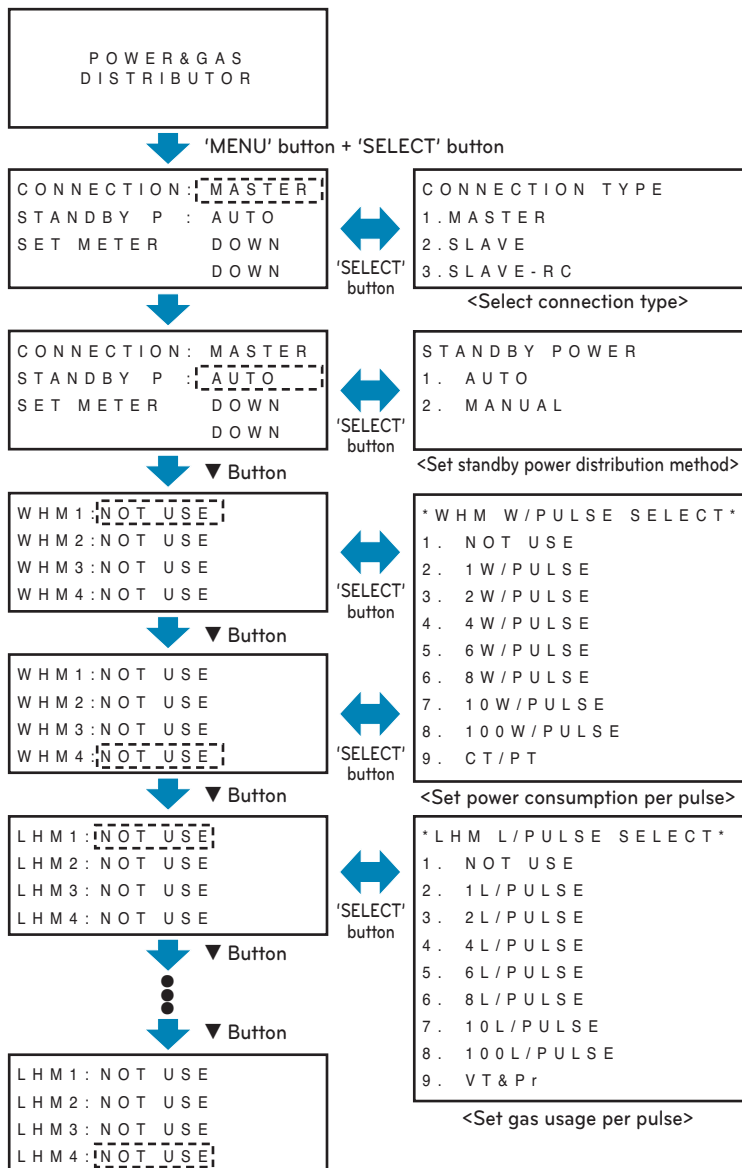

! CAUTION

- Power indicator setting only can be changed during the 20 minutes after turning on the power.
Twenty (20) minutes later, if you need to change settings, turn the power indicator on again.

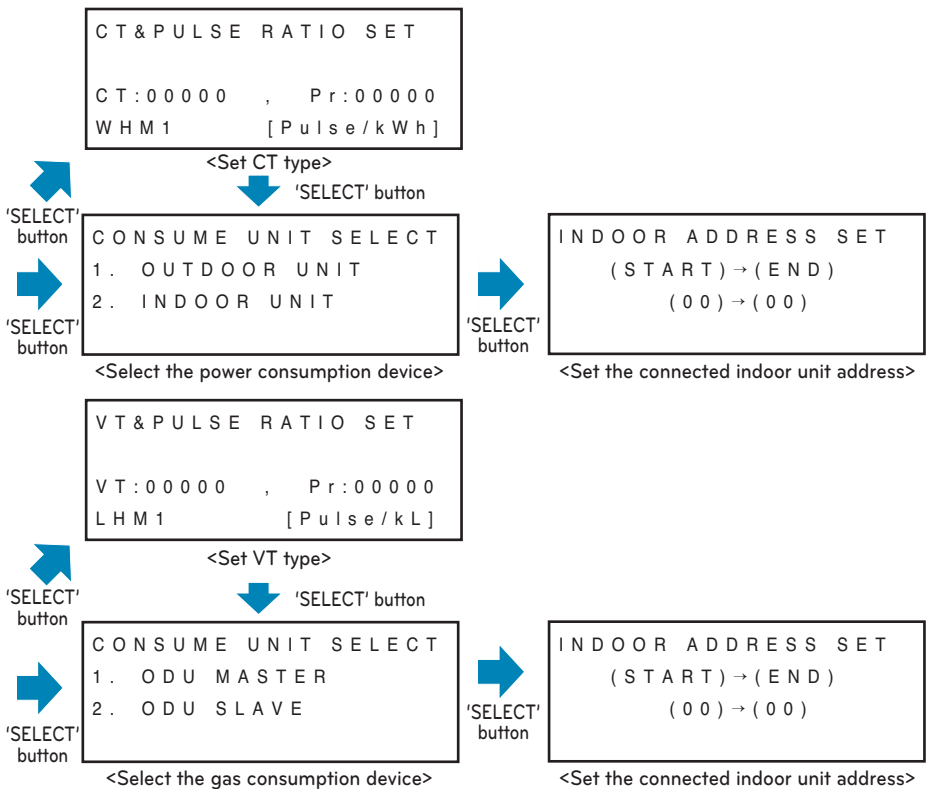

- **If entering the setting screen for the first time.**

- After turning power on, press the 'MENU' button and the 'SELECT' button at the same time and the screen will change to the screen where you can select the product connection type. Select the product type to connect, and then press the 'SELECT' button. Then, the selection of the product will be saved and the screen will be switched to the main standby screen.

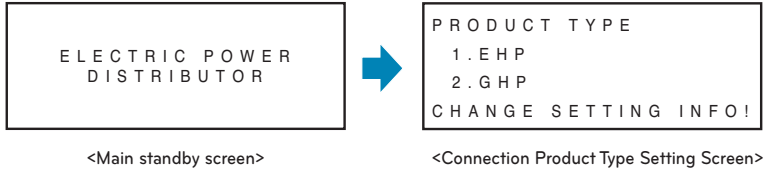

- **If after selecting the connection product type at least once, you are entering the setting screen.**

- After turning power on, press the 'MENU' button and the 'SELECT' button at the same time and then will be switched to the function setting screen.

- **After selecting EHP product**

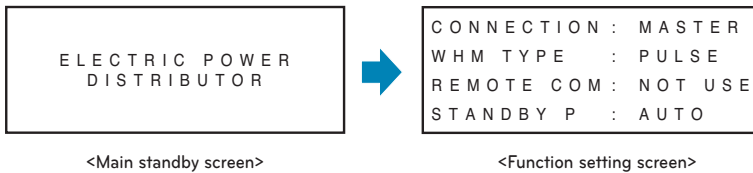

- **After selecting GHP product**

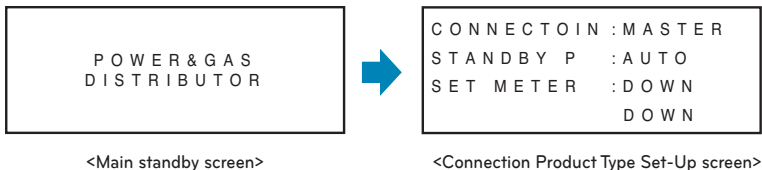

- **The item with letters blinking is the current setting location on the function setting screen.**

※ If you want to change the connection type of product

- On the function setting screen, press the (▲) button and (▼) button simultaneously, and then you can enter the connected product type setting screen.

! CAUTION

- Power indicator setting only can be changed during the 20 minutes after turning on the power. Twenty (20) minutes later, if you need to change settings, turn the power indicator on again.