



Scan the QR code to see the manual.



OWNER'S MANUAL

FREEZER



Before beginning installation, read these instructions carefully. This will simplify installation and ensure that the product is installed correctly and safely. Leave these instructions near the product after installation for future reference.

ENGLISH



MFL71737103
Rev.12_061325

www.lg.com

Copyright © 2020-2025 LG Electronics. All Rights Reserved

TABLE OF CONTENTS

This manual may contain images or content that may be different from the model you purchased.
This manual is subject to revision by the manufacturer.

SAFETY INSTRUCTIONS

READ ALL INSTRUCTIONS BEFORE USE.....3
WARNING.....3
CAUTION.....9

INSTALLATION

Before Installation11
Levelling the Appliance13
Turning on the Power.....14
Moving the Appliance for Relocation14

OPERATION

Before Use15
Product Features.....17
Control Panel18
Door Handle19
Icemaker19
Shelf21
Freezer Drawer.....21
Air Filter22

SMART FUNCTIONS

LG ThinQ Application.....23
Smart Diagnosis.....25

MAINTENANCE

Cleaning27

TROUBLESHOOTING

Before Calling for Service.....28

APPENDIX

CARING FOR THE ENVIRONMENT34

SAFETY INSTRUCTIONS

READ ALL INSTRUCTIONS BEFORE USE

The following safety guidelines are intended to prevent unforeseen risks or damage from unsafe or incorrect operation of the appliance. The guidelines are separated into 'WARNING' and 'CAUTION' as described below.

Safety Messages



This symbol is displayed to indicate matters and operations that can cause risk. Read the part with this symbol carefully and follow the instructions in order to avoid risk.



WARNING

This indicates that the failure to follow the instructions can cause serious injury or death.



CAUTION

This indicates that the failure to follow the instructions can cause the minor injury or damage to the product.

WARNING



WARNING

- To reduce the risk of explosion, fire, death, electric shock, injury or scalding to persons when using this product, follow basic precautions, including the following:

Technical Safety

- This appliance can be used by children aged from 8 years and above and persons with reduced physical, sensory or mental capabilities or lack of experience and knowledge if they have been given supervision or instruction concerning use of the appliance in a safe way and understand the hazards involved. Children shall not play with the

appliance. Cleaning and user maintenance shall not be made by children without supervision.

- This appliance is not intended for use by persons (including children) with reduced physical, sensory or mental capabilities, or lack of experience and knowledge, unless they have been given supervision or instruction concerning use of the appliance by a person responsible for their safety. Children should be supervised to ensure that they do not play with the appliance.
- Children aged from 3 to 8 years are allowed to load and unload refrigerating appliances.
- This appliance is intended to be used in household and similar applications such as:
 - staff kitchen areas in shops, offices and other working environments;
 - farm houses and by clients in hotels, motels and other residential type environments;
 - bed and breakfast type environments;
 - catering and similar non-retail applications.
- This refrigerating appliance is not intended to be used as a built-in appliance.
- This appliance is not for use in portable or mobile installations, such as marine or RV uses, where it will be in motion while operating.



This symbol alerts you to flammable materials that can ignite and cause a fire if you do not take care.

- This appliance contains a small amount of isobutane refrigerant (R600a), but it is also combustible. When transporting and installing the appliance, care should be taken to ensure that no parts of the refrigerating circuit are damaged.
- The refrigerant and insulation blowing gas used in the appliance require special disposal procedures. Consult with service agent or a similarly qualified person before disposing of them.
- Do not damage the refrigerant circuit.

- If the power cord is damaged or the hole of the outlet socket is loose, it must be replaced. Do not use the power cord and contact an authorized service centre in order to avoid a hazard.
- Do not locate multiple portable socket-outlets or portable power supplies at the rear of the appliance.
- Securely plug the power plug in the outlet socket after completely removing any moisture and dust.
- Never unplug the appliance by pulling on the power cable. Always grip the power plug firmly and pull straight out from the outlet socket.
- Keep ventilation openings, in the appliance enclosure or in the built-in structure, clear of obstruction.
- Do not store explosive substances such as aerosol cans with a flammable propellant in this appliance.
- Do not tilt the appliance to pull or push it when transporting.
- When positioning the appliance, ensure the supply cord is not trapped or damaged.
- Do not use mechanical devices or other means to accelerate the defrosting process.
- Do not use a hair drier to dry the inside of the appliance or place a candle inside to remove the odours.
- Do not use electrical appliances inside the food storage compartments of the appliance, unless they are of the type recommended by the manufacturer.
- Make sure not to get a body part such as a hand or foot stuck while moving the appliance.
- Disconnect the power cord before cleaning the appliance interior or exterior.
- Do not spray water or inflammable substances (toothpaste, alcohol, thinner, benzene, flammable liquid, abrasive, etc.) over the interior or exterior of the appliance to clean it.
- Do not clean the appliance with brushes, cloths or sponges with rough surfaces or which are made of metallic material.

- Only qualified service personnel from LG Electronics service centre should disassemble, repair, or modify the appliance. Contact an LG Electronics customer information centre if you move and install the appliance in a different location.

Risk of Fire and Flammable Materials

- If a leak is detected, avoid any naked flames or potential sources of ignition and air the room in which the appliance is standing for several minutes. In order to avoid the creation of a flammable gas air mixture if a leak in the refrigerating circuit occurs, the size of the room in which the appliance is used should correspond to the amount of refrigerant used. The room must be 1 m² in size for every 8 g of R600a refrigerant inside the appliance.
- Refrigerant leaking out of the pipes could ignite or cause an explosion.
- The amount of refrigerant in your particular appliance is shown on the identification plate inside the appliance.

Installation

- This appliance should only be transported by two or more people holding the appliance securely.
- Install the appliance on a firm and level floor.
- Do not install the appliance in a damp and dusty place. Do not install or store the appliance in any outdoor area, or any area that is subject to weathering conditions such as direct sunlight, wind, rain, or temperatures below freezing.
- Do not place the appliance in direct sunlight or expose it to the heat from heating appliances such as stoves or heaters.
- Be careful not to expose the rear of the appliance when installing.
- Install the appliance in a place where it is easy to unplug the power plug of the appliance.
- Be careful not to let the appliance door fall during assembly or disassembly.

- Be careful not to pinch, crush, or damage the power cable during assembly or disassembly of the appliance door.
- Be careful not to point the power plug up or let the appliance lean against the power plug.
- Do not connect a plug adapter or other accessories to the power plug.
- Do not modify or extend the power cable.
- Ensure that the outlet socket is properly grounded, and that the earth pin on the power cord is not damaged or removed from the power plug. For more details on grounding, inquire at an LG Electronics customer information centre.
- This appliance is equipped with a power cord having an equipment-grounding conductor and a grounding power plug. The power plug must be plugged into an appropriate outlet socket that is installed and grounded in accordance with all local codes and ordinances.
- Never start up an appliance showing any signs of damage. If in doubt, consult your dealer.
- Dispose of all packaging materials (such as plastic bags and styrofoam) away from children. The packaging materials can cause suffocation.
- Do not plug the appliance into a multi socket adapter which does not have a power cable (mounted).
- The appliance should be connected to a dedicated power line which is separately fused.
- Do not use a multi socket outlet which is not properly grounded (portable). In case of using a properly-grounded multi socket outlet (portable), use the multi socket outlet with the current capacity of the power cord rating or higher and use the multi socket outlet only for the appliance.

Operation

- Do not use the appliance for any purpose (storage of medical or experimental materials or shipping) other than any domestic household food storage use.

- If water penetrates electrical parts of the appliance, disconnect power plug and contact an LG Electronics customer information centre.
- Unplug the power plug during a severe thunderstorm or lightening or when not in use for a long period of time.
- Do not touch the power plug or the appliance controls with wet hands.
- Do not bend the power cable excessively or place a heavy object on it.
- Immediately unplug the power plug and contact an LG Electronics customer information centre if you detect a strange sound, odour, or smoke coming from the appliance.
- Do not place hands or metallic objects inside the area emitting the cold air, cover or heat releasing grille on the back.
- Do not apply excessive force or impact to the back cover of the appliance.
- Be careful of nearby children when you open or close the appliance door. The door may bump the child and cause injury.
- Avoid the danger of children getting trapped inside the appliance. A child trapped inside the appliance can cause suffocation.
- Do not put animals, such as pets into the appliance.
- Do not place heavy or fragile objects, containers filled with liquid, combustible substances, flammable objects (such as candles, lamps, etc.), or heating devices (such as stoves, heaters, etc.) on the appliance.
- Do not place any electronic appliance (such as heater and mobile phone) inside the appliance.
- If there is a gas leakage (isobutane, propane, natural gas, etc.), do not touch the appliance or power plug and ventilate the area immediately. This appliance uses a refrigerant gas (isobutane, R600a). Although it uses a small amount of the gas, it is still combustible gas. Gas leakage during appliance transport, installation or operation can cause fire, explosion or injury if sparks are caused.

- Do not use or store flammable or combustible substances (ether, benzene, alcohol, chemical, LPG, combustible spray, insecticide, air freshener, cosmetics, etc.) near the appliance.
- This appliance incorporates an earth connection for functional purposes.
- Fill with potable water only.
 - If using an icemaker, make sure to fill it with potable water only.

Disposal

- When discarding the appliance, remove the door gasket while leaving the shelves and baskets in place and keep children away from the appliance.

CAUTION

CAUTION

- To reduce the risk of minor injury to persons, malfunction, or damage to the product or property when using this product, follow basic precautions, including the following:

Installation

- After unpacking, check the appliance for any damage that may have occurred during transit.
- Wait for at least 3 to 4 hours in order to ensure the refrigerant circuit is fully efficient.
- Move the appliance carefully on sensitive floors to avoid damage to the floor.

Operation

- Do not touch frozen food or the metal parts in the freezer compartment with wet or damp hands. It may cause frostbite.

- Do not place glass containers, bottles or cans (especially those containing carbonated drinks) in the freezer compartment, shelves or ice bin that will be exposed to temperatures below freezing.
- The tempered glass on the front side of the appliance door or the shelves can be damaged by an impact. If it is broken, do not touch it with hands.
- Do not hang from the appliance doors, storage room, shelf or climb up into it.
- Do not store an excessive amount of water bottles or containers for side dishes on the door baskets.
- Do not open or close the appliance door with excessive force.
- If the hinge of the appliance door is damaged or operates improperly, stop using the appliance and contact an authorized service centre.
- Prevent animals from nibbling on the power cable or water hose.
- Never eat frozen foods immediately after they have been taken out in the freezer compartment.
- Make sure not to get a hand or foot stuck upon opening or closing the appliance door or door in door.

Maintenance

- This appliance is equipped with maintenance-free LED interior light. Do not remove cover or LED lamp in any attempt to repair or change it. Contact an LG Electronics customer information centre.
- Do not clean glass shelves or covers with warm water when they are cold. They may shatter if exposed to sudden temperature changes.
- Do not insert the shelves upside down. The shelves may fall.
- To remove frost from the appliance, contact an LG Electronics customer information centre.
- Dispose of the ice inside the ice bin in the freezer compartment during an extended power outage.

INSTALLATION

Before Installation

Dimensions and Clearances

Too small of a distance from adjacent items may result in the degradation of freezing capability and increased electricity costs. Allow over 50 mm of clearance between the back of the appliance and the wall when installing the appliance.

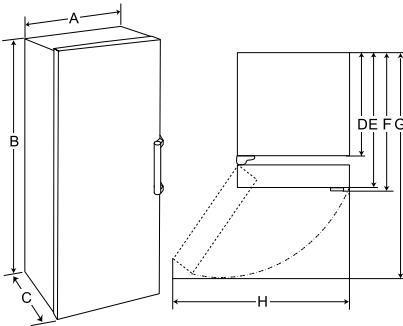

	Size (mm)
A	595
B	1 860
C	707
D	600
E	666
F	707
G	1 225
H	816

NOTE

- You can determine what type of appliance it is by looking at the label inside the appliance.
- Insulation materials of the appliance may contract or expand in response to temperature

changes. This may result in decrease or increase of the appliance width.

Ambient Temperature

- The appliance is designed to operate within a limited range of ambient temperatures, depending on the climate zone.
- The internal temperatures could be affected by the location of the appliance, the ambient temperature, the frequency of door opening and so on.
- The climate class can be found on the rating label.

Climate Class	Ambient Temperature Range °C
SN (Extended Temperate)	+10 - +32
N (Temperate)	+16 - +32
ST (Subtropical)	+16 - +38 / +18 - +38**
T (Tropical)	+10 - +43* / +16 - +43 / +18 - +43**

* Australia, India, Kenya

** Argentina

NOTE

- The appliances rated from SN to T are intended to be used at an ambient temperature between 10 °C and 43 °C.

12 INSTALLATION

Accessories

*1 This feature is only available on some models.

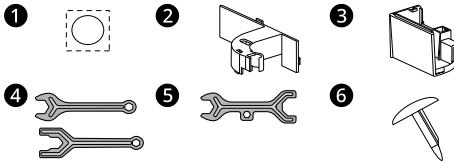

- 1 Sticker*1
- 2 Cord Holder*1
- 3 Hinge Cover*1
- 4 Spanner A*1
- 5 Spanner B*1
- 6 Door Cap*1

Reversing Doors

This feature is only available on some models. Your appliance is designed with reversible doors, do that they may open from either the left or right hand side to suit your kitchen design.

NOTE

- Reversing the doors must be performed by the qualified personnel of LG Electronics. If not, the doors will not be covered by the warranty.

Connecting the Freezer and Fridge

This feature is only available on some models.

You can install your appliance in pairs by calling to the LG Electronics service centre.

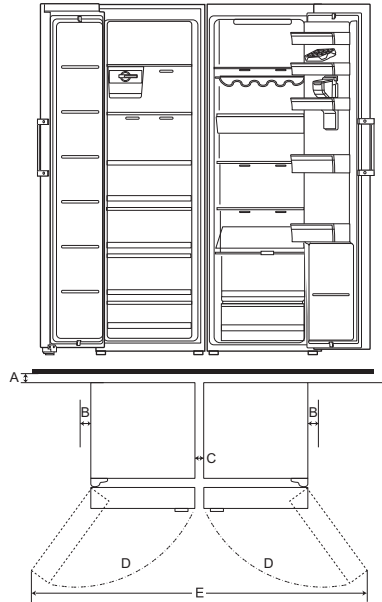

-	Size (mm)
A	Minimum 50
B	50
C	Minimum 5
D	110°
E	1 637

NOTE

- Installation condition is not covered by the warranty.
- Connecting the freezer and fridge may increase energy consumption.

Levelling the Appliance

Before Beginning

When the appliance doors appear to be uneven, follow the instructions below to align the doors.

NOTE

- The spanner may differ depending on the model. You will be provided with one of the available spanners.
- Spanner Type A

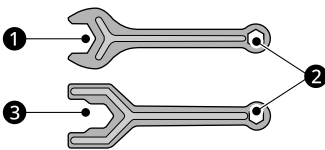

- Spanner Type B

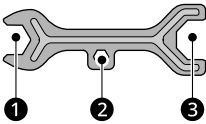

- Open the doors and check to make sure that they close easily.

Door Alignment

If the door of the appliance is not level, adjust the difference in the height of appliance door.

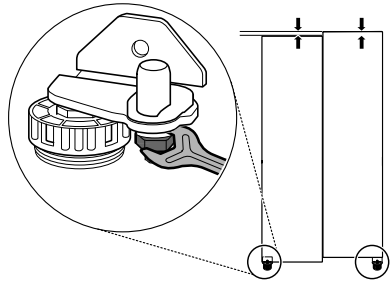

- Open the door and use the spanner 1 to loosen the keeper nut by turning it to the left.

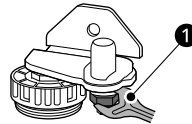

- Use the spanner 2 to adjust the height by turning the adjustment hinge pin to the left or to the right.

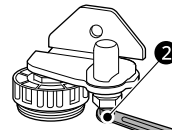

Adjusting the Levelling Leg

If the appliance seems unsteady, or the doors do not close easily, adjust the appliance's tilt using the instructions below.

- Turn the levelling leg clockwise to raise that side of the appliance or counterclockwise to lower it.

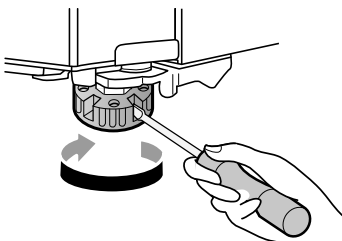

CAUTION

- Do not adjust the height of the appliance door more than 3 mm.

14 INSTALLATION

- 3** Use the spanner ① to fasten the keeper nut by turning it to the right.



NOTE

- Leveling the doors may not be possible when the floor is not leveled, or is of weak or poor construction.
 - The refrigerator is heavy and should be installed on a rigid and solid surface.
 - Some timber flooring may cause levelling difficulties if it flexes excessively.
-

Turning on the Power

Connecting the Appliance

To turn on the appliance, connect the power plug into the outlet socket. Do not double up with other appliances on the same outlet.

NOTE

- After connecting the power supply cord (or plug) to the outlet, wait enough time before you put food into the appliance. If you add food before the appliance has cooled completely, your food may spoil.
 - To turn off the appliance, disconnect the power plug from the outlet socket.
-

Moving the Appliance for Relocation

Moving the Appliance

- 1** Remove all food from inside the appliance.

- 2** Fix the power plug.

- Models with a power plug hook:
Pull the power plug out, insert and fix it into the power plug hook at the rear or on top of the appliance.
- Models without a power plug hook:
Pull the power plug out and fix the power supply cable with a tape to the side of the appliance where the power socket is located at the installation site.

- 3** Tape parts such as shelves and the door handle to prevent from falling off while moving the appliance.

- 4** Move the appliance with more than two people carefully. When transporting the appliance over a long distance, keep the appliance upright.

⚠ CAUTION

- Move the appliance carefully on sensitive floors to avoid damage to the floor.
 - Use cardboard, floor mat or carpet to prevent scratches on the floor when installing or moving the appliance.
 - Do not move the appliance in zigzags.

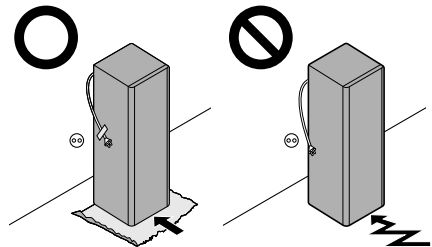

-
- 5** After installing the appliance, connect the power plug into a mains outlet socket and switch it on.

OPERATION

Before Use

Notes for Operation

- Users should keep in mind that frost can form if the door is not closed completely or if the humidity is high during the summer.
- Ensure there is sufficient space between food stored on the shelf or door basket to allow the door to close completely.
- Opening the door for long periods can cause a significant increase of the temperature in the compartments of the appliance.
- If the refrigerating appliance is left empty for long periods, switch off, defrost, clean, dry, and leave the door open to prevent mould developing within the appliance.
- Note that a temperature rise after defrosting has a permissible range in the appliance specifications. If you wish to minimise the impact on the food storage due to a temperature rise, seal or wrap the stored food in several layers.

Door Open Alarm

This feature is only available on some models. The alarm sounds if the door is left open or not completely closed.

NOTE

- Contact the LG Electronics customer information centre if the alarm sound continues even after closing all doors.

Failure Detection

The appliance can automatically detect problems during the operation.

NOTE

- If a problem is detected, the appliance may not operate and an error code is displayed even when any button is pressed.

- If an error code is indicated on the display, do not turn off the power. Immediately contact the LG Electronics customer information centre and report the error code. If you turn off the power, the repair technician from the our information centre may have difficulty finding the problem.

High Temperature Alarm

The high temperature alarm is a function that warns when the temperature of the freezer increases enough to be a problem. The freezer temperature display LED flashes and the alarm sounds.

- This alarm sounds in the following cases:
 - When the appliance is turned on for the first time (therefore the freezer temperature is high).
 - When the freezer door is open for a long time or opens very frequently.
 - When the power goes out for a long period of time.
 - When larger amounts of hot food are placed into the freezer.

Turning off the Alarm

Press the **Freezer** button until the alarm stops ringing.

Suggestion for Energy Saving

- For the most efficient use of energy, keep all inner parts (e.g. door bins, drawers and shelves) on their original location. Altering their positions may result in less efficient energy consumption or performance.
- Ensure there is sufficient space between stored foods. This allows cold air to be circulated evenly and lowers electricity bills.
- Store hot food only after it has cooled in order to prevent dew or frost.

- When storing food in the freezer compartment, set the freezer temperature lower than the temperature indicated on the food.
- Do not set the temperature of the appliance lower than needed.
- The automatic defrosting system in the appliance ensures that the compartment remains free of ice buildup under normal operating conditions.

Storing Foods Effectively

- Food may freeze or spoil if stored at the wrong temperature. Set the appliance to the correct temperature for the food being stored.
- Store frozen food or refrigerated food inside sealed containers.
- Check the expiration date and label (storage instructions) before storing food in the appliance.
- Do not place unfrozen food in direct contact with food that is already frozen. It could be necessary to reduce the quantity to be frozen if freezing every day is anticipated.
- Place the food in the appliance immediately after purchasing.
- Store raw meat and fish in suitable containers in the appliance, so that it is not in contact with or drip onto other food.
- Avoid refreezing any food which has been completely thawed. Freezing any food which has been completely thawed again will lower its taste and nutrition.
- Cool hot food before storing. If too much hot food is placed inside, the internal temperature of the appliance can increase and negatively affect other foods stored in the appliance.
- Do not overfill the appliance. Cold air can not circulate properly if the appliance is overfilled.
- If you set an excessively low temperature for food, it may become frozen. Do not set a temperature lower than the required temperature for the food to be stored correctly.
- In the event of a blackout, call the electricity company and ask how long it is going to last.
 - You should avoid door openings while the power is off.

- When the power supply gets back to normal, check the condition of the food.

Maximum Freezing Capacity

- For maximum freezing capacity, set the freezer temperature to the coldest temperature setting.
- **Express Freeze** function will allow the freezer to reach its maximum freezing capacity. This generally takes up to 24 hours and automatically switches off.
- **Express Freeze** must be switched on for 7 hours before fresh products are placed in the freezer compartment.
- To freeze food items quickly, store the food in the shelf zone. Food items will freeze most quickly in the zone.
- To get better air circulation, insert all inner parts like baskets, drawers, and shelves.

Freezing the Maximum Amount of Food

If large quantities of food are to be stored, all the freezer drawers should be taken out of the appliance and the food shall be stacked directly on the freezer shelves in the freezer compartment.

CAUTION

- To remove the drawers, first remove the food from drawers and then pull out the drawers carefully. Not doing so could cause injury or damage to the drawers.

NOTE

- To get better air circulation, insert all drawers.
 - The shape of each drawer may be different, insert in the right position.
-

Product Features

The appearance or components of the appliance may differ from model to model.

Interior

*1 This feature is only available on some models.

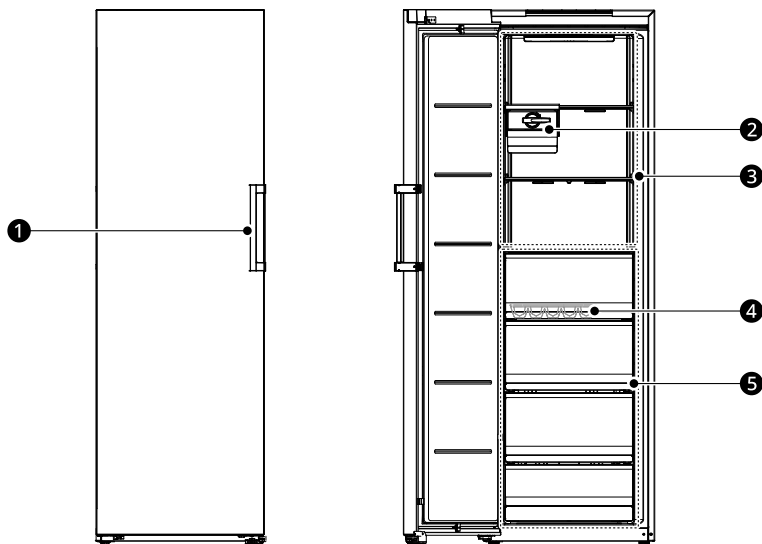

① Door Handle

Pull the handle to open the door.

② Icemaker*1

Stores ice produced by the manually icemaker.

- You can slide the icemaker along the shelf from side to side to any desired position.

③ Freezer Shelf

This is where frozen foods such as meat, fish, and ice cream can be stored.

- Do not store ice cream or food which will be stored for a long period of time.
- The actual number of shelves will differ from model to model.

④ Ice Tray*1

This is where ice is manually produced.

⑤ Freezer Drawer

Stores frozen food for longer storage.

Control Panel

The actual control panel may differ from model to model.

Control Panel and Functions

*1 This feature is only available on some models.

Type 1. On the Freezer Door

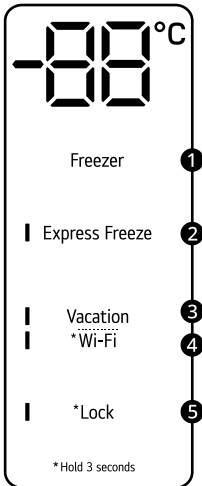

Type 2. Inside the Freezer

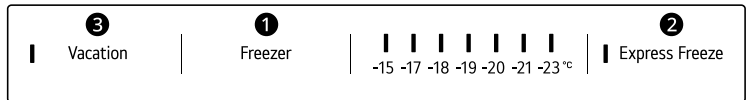

① Freezer

Press this button repeatedly to select a desired temperature between -15 °C and -23 °C.

- The default freezer temperature is -19 °C.

② Express Freeze

This function can quickly freeze a large amount of ice or frozen foods.

- This function is enabled and disabled in turn each time you press the button.
- This function automatically terminates after a specific period has passed.
- When this mode is on, noise may occur and energy consumption may increase.

③ Vacation

This function is useful when you are away on a holiday. When this function is on, the freezer temperature is -15 °C. When this function is off, the freezer temperature return to the previous temperature settings.

- This function is enabled and disabled in turn each time you press the button.
- When this function is on, the other buttons except **Lock** and **Wi-Fi** buttons will not operate.

⚠ CAUTION

- When this function is on, be careful about storing foods that require a lower temperature than the default temperature.
- When you return home, remember to turn this function off to unlock the other buttons and return the refrigerator to its previous temperature settings.

④ Wi-Fi*¹

The **Wi-Fi** button, when used with the **LG ThinQ** app, allows the refrigerator to connect to a home Wi-Fi network. Refer to **Smart Functions** for information on the initial setup of the application.

- Press and hold the Wi-Fi button for 3 seconds to connect to the network.

⑤ Lock*¹

The lock function disables every other button on the display.

- When power is initially connected to the refrigerator, the lock function is off.
- To lock the control panel buttons, press and hold the **Lock** button for 3 seconds and the function is activated.
- To disable the function, press and hold the **Lock** button for 3 seconds.

NOTE

- For optimal food preservation, increasing or decreasing 1 °C from the default temperature is recommended.
- The control panel will turn off automatically for energy saving.
- If there is any finger or skin contacts to the control panel while cleaning it, the button function may operate.

Door Handle

The appearance or components of the appliance may differ from model to model.

Using Easy Open Door

To easily open the door, hold the handle and softly turn it to the right.

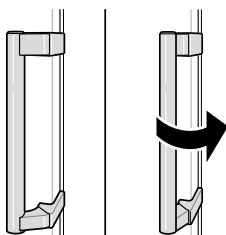

Icemaker

This feature is only available on some models.

Using the Icemaker

This feature is only available on some models.

This is where ice is manually produced.

20 OPERATION

- 1 Hold the handle of ice tray and pull it out.

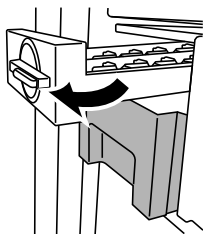

- 2 Fill the ice tray with potable water up to the water line.

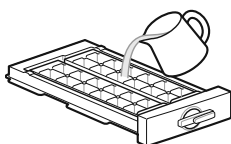

- 3 Place the ice tray back to its position carefully.

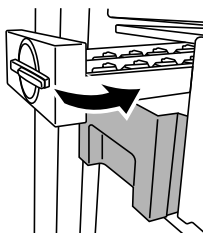

- 4 Rotate the icemaker handle clockwise.

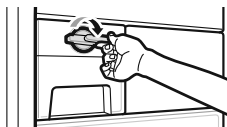

- 5 Lift and remove the ice storage bin slightly.

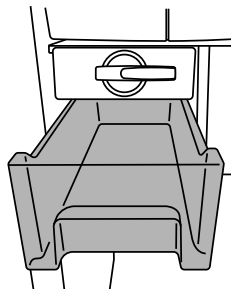

⚠ WARNING

- Fill with potable water only.
-

⚠ CAUTION

- Be careful not to twist the ice tray with force as it can be broken.
 - If you open and close the freezer door frequently, it may take longer for water to be frozen.
-

NOTE

- If the ice tray is overfilled, the ice cubes may stick together and be difficult to remove.
 - Press the **Express Freeze** button on the control panel to make ice quickly.
 - Ice can be removed more easily by pouring water on the ice tray.
 - You can remove the icemaker or ice storage bin to create more space inside the freezer if you do not use it.
-

Using the Ice Tray

This feature is only available on some models. This is where ice is manually produced.

Fill the ice tray with water up to the marked water line.

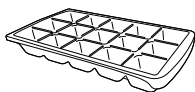

⚠ WARNING

- Fill with potable water only.

⚠ CAUTION

- Be careful not to twist the ice tray with force as it can be broken.
- If you open and close the freezer door frequently, it may take longer for water to be frozen.

NOTE

- If the ice tray is overfilled, the ice cubes may stick together and be difficult to remove.
- Ice can be removed more easily by pouring water on the ice tray.

Shelf

Removing/Refitting the Shelf

- 1 Hold the both side of the shelf. Lift the shelf up and pull it forward.

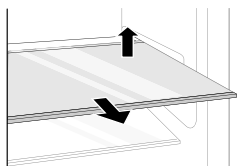

- 2 Tilt the shelf and remove it by pulling it out.

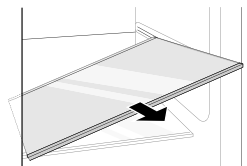

- 3 Refit the shelf by sliding it inward until the shelf snaps into the frame.

Freezer Drawer

Removing/Refitting the Freezer Drawer

- 1 Remove the contents of the drawer. Hold the handle of the drawer and pull it out completely until it stops.
- 2 Lift the drawer up and remove it by pulling it out.

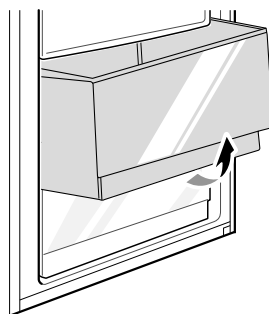

- 3 Refit the drawer in the reverse order of the removal process.

Air Filter

Reusing the Air Filter

You can remove the odors absorbed by the Air Filter and reuse it.

- 1 Pull out the drawer in the on the bottom compartment.

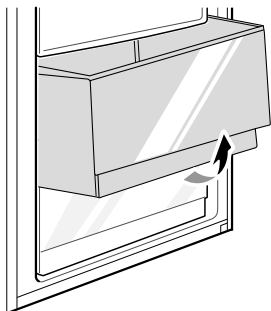

- 2 Press on the hook inside the top compartment, and then take out the Air Filter.

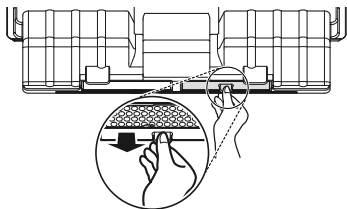

- 3 Dry it using a hair dryer or by exposing it to sunlight. The filter is reusable.

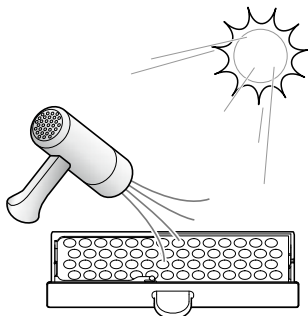

- To increase deodorizing performance, a natural palm wood material is attached to the filter. If residue falls off, it will not harm you and can be wiped off easily with a towel or cloth.

SMART FUNCTIONS

LG ThinQ Application

This feature is only available on models with Wi-Fi. The **LG ThinQ** application allows you to communicate with the appliance using a smartphone.

LG ThinQ Application Features

Communicate with the appliance from a smartphone using the convenient smart features.

Smart Diagnosis

- If you experience a problem while using the appliance, this smart diagnosis feature will help you diagnose the problem.

Settings

- Allows you to set various options on the appliance and in the application.

NOTE

- In the following cases, you must update the network information for each appliance in the **LG ThinQ** application under **Device Cards > Settings > Change Network**.
 - wireless router is changed
 - wireless router password is changed
 - Internet service provider is changed
- The application is subject to change for appliance improvement purposes without notice to users.
- Functions may vary by model.

Installing LG ThinQ Application and Connecting an LG Appliance

Models with QR Code

Scan the QR code attached to the product using the camera or a QR code reader application on your smartphone.



Models without QR Code

- 1 Search for and install the **LG ThinQ** application from the Google Play Store or Apple App Store on a smartphone.
- 2 Run the **LG ThinQ** application and sign in with your existing account or create an LG account to sign in.
- 3 Touch the add (+) button on the **LG ThinQ** application to connect your LG appliance. Follow the instructions in the application to complete the process.

NOTE

- To verify the Wi-Fi connection, check that the Wi-Fi indicator on the control panel is lit.

NOTE

- The appliance supports 2.4 GHz Wi-Fi networks only. To check your network frequency, contact your Internet service provider or refer to your wireless router manual.
- **LG ThinQ** is not responsible for any network connection problems or any faults, malfunctions, or errors caused by network connection.
- The surrounding wireless environment can make the wireless network service run slowly.
- If the distance between the appliance and the wireless router is too far, the signal strength becomes weak. It may take a long time to connect or installation may fail.
- If the appliance is having trouble connecting to the Wi-Fi network, it may be too far from the router. Purchase a Wi-Fi repeater (range extender) to improve the Wi-Fi signal strength.
- The network connection may not work properly depending on the Internet service provider.
- The Wi-Fi connection may not connect or may be interrupted because of the home network environment.
- The appliance cannot be connected due to problems with the wireless signal transmission. Unplug the appliance and wait about a minute before trying again.
- If the firewall on your wireless router is enabled, disable the firewall or add an exception to it.
- The wireless network name (SSID) should be a combination of English letters and numbers. (Do not use special characters.)
- Smartphone user interface (UI) may vary depending on the mobile operating system (OS) and the manufacturer.
- If the security protocol of the router is set to **WEP**, you may fail to set up the network. Please change it to other security protocols (**WPA2** is recommended) and connect the product again.
- To disable the Wi-Fi function, press and hold the **Wi-Fi** button for 3 seconds. The Wi-Fi indicator will be turned off.
- To reconnect the appliance or add another user, press and hold the **Wi-Fi** button for 3 seconds to temporarily turn it off. Run the **LG ThinQ**

application and follow the instructions in the application to connect the appliance.

Radio Equipment Specifications

Type	Operating Frequency Range	Output Power (Max.)
Wireless LAN	2 400 MHz - 2 483,5 MHz	< 100 mW
Bluetooth*1		

*1 This feature is only available on some models.

Wireless function S/W version: V 1,0

For consideration of the user, this device should be installed and operated with a minimum distance of 20 cm between the device and the body.

Declaration of Conformity



Hereby, LG Electronics declares that the radio equipment type Refrigerator is in compliance with Directive 2014/53/EU. The full text of the EU declaration of conformity is available at the following internet address:

<http://www.lg.com/global/support/cedoc/cedoc#>

Open Source Software Notice Information

To obtain the source code that is contained in this product, under GPL, LGPL, MPL, and other open source licenses that have the obligation to disclose source code, and to access all referred license terms, copyright notices and other relevant documents, please visit <https://opensource.lge.com>.

LG Electronics will also provide open source code to you on CD-ROM for a charge covering the cost of performing such distribution (such as the cost of

media, shipping, and handling) upon email request to opensource@lge.com.

This offer is valid to anyone in receipt of this information for a period of three years after our last shipment of this product.

Smart Diagnosis

Use this feature to help you diagnose and solve problems with your appliance.

NOTE

- For reasons not attributable to LGE's negligence, the service may not operate due to external factors such as, but not limited to, Wi-Fi unavailability, Wi-Fi disconnection, local app store policy, or app unavailability.
- The feature may be subject to change without prior notice and may have a different form depending on where you are located.

Using LG ThinQ to Diagnose Issues

If you experience a problem with your Wi-Fi equipped appliance, it can transmit troubleshooting data to a smartphone using the **LG ThinQ** application.

- Launch the **LG ThinQ** application and select the **Smart Diagnosis** feature in the menu. Follow the instructions provided in the **LG ThinQ** application.

Using Audible Diagnosis to Diagnose Issues

*1 This control panel is only available on some models.

Follow the instructions below to use the audible diagnosis method.

- Launch the **LG ThinQ** application and select the **Smart Diagnosis** feature in the menu. Follow the instructions for audible diagnosis provided in the **LG ThinQ** application.

Control Panel 1: On the Freezer Door*1

- 1 Press the **Lock** button to activate the lock function.
 - If the display has been locked for over 5 minutes, you must deactivate the lock and then reactivate it.
- 2 Press and hold the **Freezer** button for 3 seconds or longer.
- 3 Open the door and then hold the phone near the speaker hole.

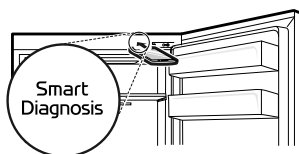

- 4 After the data transfer is complete, the diagnosis will be displayed in the application.

Control Panel 2: Inside the Freezer*1

- 1 Open the freezer door.
- 2 Press and hold the **Freezer** button for 3 seconds or longer.
- 3 Hold the phone near the speaker hole.

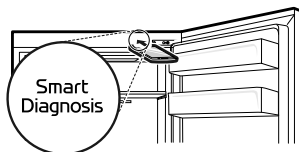

- 4 After the data transfer is complete, the diagnosis will be displayed in the application.

NOTE

- For best results, do not move the phone while the tones are being transmitted.
-

MAINTENANCE

Cleaning

General Cleaning Tips

- Performing manual defrosting, maintenance or cleaning of the appliance while food is stored in the freezer can raise the temperature of the food and reduce its storage life.
- Regularly clean any surfaces that can come in contact with food.
- When cleaning the inside or outside of the appliance, do not wipe it with a rough brush, toothpaste, or flammable materials. Do not use cleaning agents containing flammable substances. This may cause discolouration or damage to the appliance.
 - Flammable substances: alcohol (ethanol, methanol, isopropyl alcohol, isobutyl alcohol, etc.), thinner, bleach, benzene, flammable liquid, abrasive, etc.
- After cleaning, check if the power cable is damaged.

Cleaning the Exterior

- When cleaning the outside air vents of the appliance by means of vacuuming, then the power cord should be unplugged from the outlet to avoid any static discharge that can damage the electronics or cause an electric shock. Regular cleaning of the rear and side ventilation covers is recommended to maintain reliable and economical operation of the unit.
- Keep the air vents on the exterior of the appliance clean. Blocked air vents can cause fire or appliance damage.
- For the appliance exterior, use a clean sponge or soft cloth and a mild detergent in warm water. Do not use abrasive or harsh cleaners. Dry thoroughly with a soft cloth. Do not use contaminated cloths when cleaning the stainless steel doors. Always use a dedicated cloth and wipe in the same direction as the grain. This helps reduce surface staining and tarnishing.

Cleaning the Interior

- When removing a shelf or drawer from inside the appliance, remove all stored foods from the shelf or drawer to prevent injury or damage to the appliance. Otherwise, injury may occur due to the weight of stored foods.
- Detach the shelves and drawers and clean them with water, and then dry them sufficiently, before replacing them.
- Regularly wipe the door gaskets with a wet soft towel.
- Door basket spills and stains should be cleaned as they can compromise storage ability of the basket and could even be damaged.
- Never clean the shelves or containers in the dishwasher. The parts may become deformed due to the heat.

TROUBLESHOOTING

Before Calling for Service

Cooling

Symptoms	Possible Cause & Solution
There is no refrigeration or freezing.	Is there a power interruption? <ul style="list-style-type: none"> Check the power of other appliances.
	Appliance is unplugged. <ul style="list-style-type: none"> Plug the power plug in the outlet properly.
	A fuse in your home may be blown or the circuit breaker tripped. Or the appliance is connected to a GFCI (Ground Fault Circuit Interrupter) outlet, and the outlet's circuit breaker has tripped. <ul style="list-style-type: none"> Check the main electrical box and replace the fuse or reset the circuit breaker. Do not increase fuse capacity. If the problem is a circuit overload, have it corrected by a qualified electrician. Reset the circuit breaker on the GFCI. If the problem persists, contact an electrician.
There is poor refrigeration or freezing.	Is the fridge or freezer temperature set to its warmest setting? <ul style="list-style-type: none"> Set the fridge or freezer temperature to a colder setting.
	Is the appliance in direct sunlight, or is it near a heat generating object such as cooking oven or heater? <ul style="list-style-type: none"> Check the installation area and reinstall it away from heat generating objects.
	Did you store hot food without cooling it first? <ul style="list-style-type: none"> Cool the hot food first before putting it in the fridge or freezer compartment.
	Did you put in too much food? <ul style="list-style-type: none"> Maintain an appropriate space between food.
	Are the appliance doors completely closed? <ul style="list-style-type: none"> Completely close the door and make sure that stored food is not obstructing in the door.
	Is there enough space around the appliance? <ul style="list-style-type: none"> Adjust the installation position to make enough space around the appliance.
The appliance contains a bad smell.	Is the fridge or freezer temperature set to 'Warm'? <ul style="list-style-type: none"> Set the fridge or freezer temperature to a colder setting.

Symptoms	Possible Cause & Solution
The appliance contains a bad smell.	Did you put in food with a strong smell? <ul style="list-style-type: none"> Store foods with strong smells in a sealed containers.
	Vegetables or fruit may have spoiled in the drawer? <ul style="list-style-type: none"> Throw away rotten vegetables and clean the vegetable drawer. Do not store vegetables too long in the vegetable drawer.

Condensation & Frost

Symptoms	Possible Cause & Solution
There is condensation inside the appliance or on the bottom of the vegetable drawer cover.	Did you store hot food without cooling it first? <ul style="list-style-type: none"> Cool the hot food first before putting it inside the fridge or freezer.
	Did you leave the appliance door open? <ul style="list-style-type: none"> Although the condensation will disappear soon after you close the appliance door, you can wipe it with a dry cloth.
	Do you open and close the appliance door too frequently? <ul style="list-style-type: none"> Condensation can form due to the temperature difference from the outside. Wipe out the dampness with a dry cloth.
	Did you put warm or moist food inside without sealing it in a container? <ul style="list-style-type: none"> Store food in a covered or sealed container.
Frost has formed in the freezer compartment.	Doors may not be closed properly? <ul style="list-style-type: none"> Check if the food item inside the appliance is blocking the door and make sure that the door is tightly closed.
	Did you store hot food without cooling it first? <ul style="list-style-type: none"> Cool the hot food first before putting it in the fridge or freezer compartment.
	Is the air entry or exit of the freezer compartment blocked? <ul style="list-style-type: none"> Make sure that air entry or exit is not blocked so that the air can circulate inside.
	Is the freezer compartment overfilled? <ul style="list-style-type: none"> Maintain an appropriate space between items.
Frost or condensation has formed inside or outside the appliance.	Did you open and close the appliance door frequently or is the appliance door improperly closed? <ul style="list-style-type: none"> Frosts or condensation can form if the outside air penetrates inside the appliance.

Symptoms	Possible Cause & Solution
Frost or condensation has formed inside or outside the appliance.	<p>Is the installation environment humid?</p> <ul style="list-style-type: none"> Condensation can appear on the exterior of the appliance if the installation area is too humid or on a humid day such as a rainy day. Wipe off any moisture with a dry cloth.
The side or front of the appliance is warm.	<p>There are anti condensation pipes fitted to these areas of the appliance to reduce condensation forming from around the door area.</p> <ul style="list-style-type: none"> The heat releasing pipe to prevent condensation is installed on the front and side of the appliance. You may feel it particularly hot right after the appliance is installed or during the summer. You can be assured that this is not a problem and is quite normal.
There is water inside or outside of the appliance.	<p>Is there water leakage around the appliance?</p> <ul style="list-style-type: none"> Check if the water has leaked from a sink or another place.
	<p>Is there water on the bottom of the appliance?</p> <ul style="list-style-type: none"> Check if the water is from the thawed frozen food or a broken or dropped container.

Parts & Features

Symptoms	Possible Cause & Solution
The appliance door is not closed tightly.	<p>Is the appliance leaning forward?</p> <ul style="list-style-type: none"> Adjust the front feet to raise the front side slightly. Were the shelves properly assembled? Refit the shelves if needed.
	<p>Did you close the door with excessive force?</p> <ul style="list-style-type: none"> If you apply too much force or speed when closing the door, it may remain briefly open before closing. Make sure that you do not slam the door closed. Close without force.
It is difficult to open the appliance door.	<p>Did you open the door right after you closed it?</p> <ul style="list-style-type: none"> If you try to open the appliance door within one minute after you closed it, you may have difficulties because of the pressure inside the appliance. Try to open the appliance door again in a few minutes so that the internal pressure stabilizes.
The inside lamp in the appliance does not turn on.	<p>Lamp failure</p> <ul style="list-style-type: none"> Close the door and re-open. If the lamp does not turn on, please contact the LG Electronics customer information centre. Do not attempt removal of the lamp.

Noises

Symptoms	Possible Cause & Solution
The appliance is noisy and generates abnormal sounds.	Is the appliance installed on a weak floor or improperly levelled? <ul style="list-style-type: none"> • Install the appliance on a solid and flat area.
	Does the rear of the appliance touch the wall? <ul style="list-style-type: none"> • Adjust the installation position to allow enough clearance around the appliance.
	Are objects scattered behind the appliance? <ul style="list-style-type: none"> • Remove the scattered objects from behind the appliance.
	Is there an object on top of the appliance? <ul style="list-style-type: none"> • Remove the object on top of the appliance.
Clicking noises	The defrost control will click when the automatic defrost cycle begins and ends. The thermostat control (or appliance control on some models) will also click when cycling on and off. <ul style="list-style-type: none"> • Normal Operation
Rattling noises	Appliance is not resting evenly on the floor. <ul style="list-style-type: none"> • Floor is weak or uneven or levelling legs need to be adjusted.
	Appliance with a compressor was moved while operating. <ul style="list-style-type: none"> • Normal operation. If the compressor does not stop rattling after three minutes, turn the power to the appliance off and then on again.
Whooshing noises	Evaporator fan motor is circulating air through the fridge and freezer compartments. <ul style="list-style-type: none"> • Normal Operation
	Air is being forced over the condenser by the condenser fan. <ul style="list-style-type: none"> • Normal Operation
Gurgling noises	Appliance flowing through the cooling system. <ul style="list-style-type: none"> • Normal Operation
Popping noises	Contraction and expansion of the inside walls due to changes in temperature. <ul style="list-style-type: none"> • Normal Operation
Vibrating	If the side or back of the appliance is touching a cabinet or wall, some of the normal vibrations may make an audible sound. <ul style="list-style-type: none"> • To eliminate the noise, make sure that the sides and back do not make any contact with any wall or cabinet.

Wi-Fi

Symptoms	Possible Cause & Solution
Your home appliance and smartphone are not connected to the Wi-Fi network.	The password for the Wi-Fi that you are trying to connect to is incorrect. <ul style="list-style-type: none"> Find the Wi-Fi network connected to your smartphone and remove it, then register your appliance on LG ThinQ.
	Mobile data for your smartphone is turned on. <ul style="list-style-type: none"> Turn off the Mobile data of your smartphone and register the appliance using the Wi-Fi network.
	The wireless network name (SSID) is set incorrectly. <ul style="list-style-type: none"> The wireless network name (SSID) should be a combination of English letters and numbers. (Do not use special characters.)
	The router frequency is not 2.4 GHz. <ul style="list-style-type: none"> Only a 2.4 GHz router frequency is supported. Set the wireless router to 2.4 GHz and connect the appliance to the wireless router. To check the router frequency, check with your Internet service provider or the router manufacturer.
	The distance between the appliance and the router is too far. <ul style="list-style-type: none"> If the distance between the appliance and the router is too far, the signal may be weak and the connection may not be configured correctly. Move the location of the router so that it is closer to the appliance.

Customer Care and Service

Contact an LG Electronics customer information centre.

- To find information on LG authorized service centre, visit our website at www.lg.com.
- Only qualified service personnel from LG authorized service centre should disassemble, repair, or modify the appliance.
- The minimum warranty period of this refrigerating appliance is 24 months.
- Spare parts referenced in Regulation EU 2019/2019 are available for 7 years (only door gaskets are available for 10 years).
- To purchase spare parts, contact an LG Electronics customer information centre or our website at www.lg.com.

NOTE

- Regulation EU 2019/2019, valid from 1st March 2021, is related to the Energy Efficiency classes by Regulation EU 2019/2016.
- For more information about the energy efficiency of the appliance, visit <https://eprel.ec.europa.eu> and search using the model name (valid from 1st March 2021).
- Scan the QR code on the energy label supplied with the appliance, which provides a web link to the information related to the performance of the appliance in the EU EPREL database. Keep the energy label for reference and all other documents supplied with the appliance (valid from 1st March 2021).

- The model name can be found on the rating label of the appliance.
- This product contains a light source of energy efficiency class G.

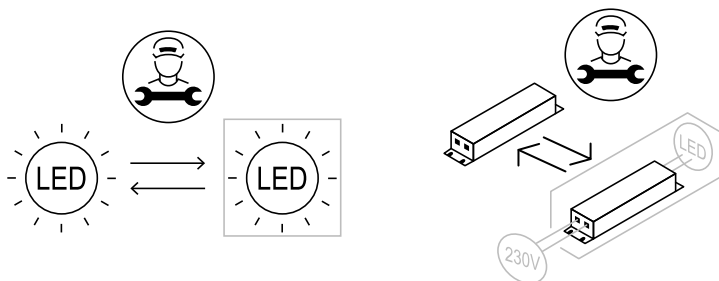

APPENDIX

CARING FOR THE ENVIRONMENT

Disposal of Your Old Appliance



ENGLISH

Disposal of Your Old Appliance

- This crossed-out wheeled bin symbol indicates that waste electrical and electronic products (WEEE) should be disposed of separately from the municipal waste stream.
- Old electrical products can contain hazardous substances so correct disposal of your old appliance will help prevent potential negative consequences for the environment and human health. Your old appliance may contain reusable parts that could be used to repair other products, and other valuable materials that can be recycled to conserve limited resources.
- You can take your appliance either to the shop where you purchased the product, or contact your local government waste office for details of your nearest authorised WEEE collection point. For the most up to date information for your country please see www.lg.com/global/recycling.

БЪЛГАРСКИ

Изхвърляне на стария уред

- Символът със зачертаня контейнер показва, че отпадъците от електрическо и електронно оборудване (ОЕЕО) трябва да се изхвърлят отделно от битовите отпадъци.

- Старите електрически продукти могат да съдържат опасни вещества и правилното изхвърляне на Вашия уред ще помогне за предотвратяване на негативните последиствия за околната среда и човешкото здраве. Вашият стар уред може да съдържа части за многократна употреба, които биха могли да бъдат използвани за ремонт на други продукти, както и други ценни материали, които могат да бъдат рециклирани с цел запазване на ограничените ресурси.
- Можете да занесете Вашия уред или в магазина, от който сте го закупили или можете да се свържете с местния държавен офис за отпадъците, за да получите информация за най-близкия разрешен ОЕЕО пункт за събиране на отпадъци. За най-актуална информация от Вашата държава, моля, погледнете тук: www.lg.com/global/recycling

CATALÀ

Eliminació de l'aparell antic

- Aquest símbol d'un contenidor ratllat indica que els residus de productes elèctrics i electrònics (RAEE) s'han d'eliminar per separat de la resta de residus municipals.
- Els productes elèctrics antics poden contenir substàncies perilloses, de manera que l'eliminació correcta del vostre aparell antic ajudarà a prevenir possibles conseqüències negatives per al medi ambient i la salut humana. El vostre aparell antic pot contenir peces reutilitzables que es podrien utilitzar per reparar altres productes, i altres materials valuosos que es poden reciclar per conservar recursos limitats.
- Podeu portar el vostre aparell a la botiga on el va comprar, o bé posar-vos en contacte amb l'oficina de residus de la vostra administració local per tal d'obtenir informació sobre el vostre punt de recollida de RAEE autoritzat més proper. Per obtenir la informació més actualitzada del vostre país, consulteu www.lg.com/global/recycling.



- Du kan enten tage apparatet til den butik hvor du købte det, eller kontakte dit lokale affaldskontor angående oplysninger om det nærmeste, autoriserede WEEE-samlepunkt. Find de sidste nye oplysninger for dit land på www.lg.com/global/recycling

ČEŠTINA

Likvidace starého přístroje

- Tento symbol přeškrtnutého koše značí, že odpad z elektrických a elektronických výrobků (WEEE) je nutné likvidovat odděleně od linky komunálního odpadu.
- Staré elektrické výrobky mohou obsahovat nebezpečné látky, takže správná likvidace starých přístrojů pomůže zabránit potenciálním negativním důsledkům pro životní prostředí a lidské zdraví. Staré přístroje mohou obsahovat znovu použitelné díly, které lze použít k opravě dalších výrobků a další cenné materiály, které lze recyklovat a šetřit tak omezené zdroje.
- Spotřebič můžete zanešt buď do obchodu, kde jste ho zakoupili nebo se obrátit na místní správu komunálních odpadů, kde získáte podrobné informace o autorizovaném sběrném místě WEEE. Pro poslední aktuální informace z vaší země si prosím prostudujte web www.lg.com/global/recycling

DANSK

Bortskaffelse af dit gamle apparat

- Dette symbol med en affaldsspand med kryds over angiver at elektrisk og elektronisk affald (WEEE) skal bortskaffes og genbruges korrekt, adskilt fra kommunens husholdningsaffald.
- Gamle elektriske produkter kan indeholde farlige stoffer, så når du bortskaffer dit gamle apparat på korrekt vis, hjælper du med at forhindre mulige negative konsekvenser for miljø og mennesker. Dit gamle apparat kan indeholde dele som kan genbruges, fx til at reparere andre produkter, eller værdifulde materialer som kan genbruges og derved begrænse spild af værdifulde ressourcer.



DEUTSCH

Entsorgung Ihrer Altgeräte

- Das durchgestrichene Symbol eines fahrbaren Abfallbehälters weist darauf hin, dass Elektro- und Elektronik-Produkte (WEEE) getrennt vom Hausmüll entsorgt werden müssen. Bitte entsorgen Sie Altgeräte getrennt von anderem Abfall und bringen Sie diese zu einer ausgewiesenen Sammelstelle für das Recycling von elektrischen und elektronischen Geräten. Falls die Geräte Batterien oder Lampen enthalten, die vom Endverbraucher ohne Beschädigung leicht entnommen werden können, trennen Sie diese bitte vor der Entsorgung von den Hauptgeräten, es sei denn, Sie möchten, dass die alten Geräte wiederverwendet werden (alte Batterien und Lampen werden getrennt gesammelt). Bitte beachten Sie auch, dass Sie persönlich dafür verantwortlich sind, personenbezogene Daten auf dem Gerät zu löschen, bevor Sie Ihre Geräte entsorgen.
- Alte elektrische Produkte können gefährliche Substanzen enthalten, die eine korrekte Entsorgung dieser Altgeräte erforderlich machen, um schädliche Auswirkungen auf die Umwelt und die menschliche Gesundheit zu vermeiden. Ihre ausgedienten Geräte können wiederverwendbare Teile enthalten, mit denen möglicherweise andere Produkte repariert werden können, aber auch sonstige wertvolle Materialien enthalten, die zur Schonung knapper Ressourcen recycelt werden können.
- Sie können Ihr Gerät entweder in den Laden zurückbringen, in dem Sie das Produkt ursprünglich erworben haben oder Sie kontaktieren Ihre Gemeindeabfallstelle für Informationen über die nächstgelegene autorisierte WEEE Sammelstelle. Bitte beachten Sie, dass einige* Vertrieber verpflichtet sind :
 - bei der Abgabe eines neuen Elektro- oder Elektronikgerätes an einen Endnutzer ein Altgerät des Endnutzers der gleichen Geräteart unentgeltlich zurückzunehmen, und
- Altgeräte, die in keiner äußeren Abmessung größer als 25 Zentimeter sind, im Einzelhandelsgeschäft oder in unmittelbarer Nähe hierzu unentgeltlich zurückzunehmen; Wenn Offline oder Online Händler Neugeräte an Privathaushalte liefern, sind sie verpflichtet, Altgeräte direkt bei diesen abzuholen oder Rückgabemöglichkeiten in zumutbarer Entfernung anzubieten. Daher empfehlen wir Ihnen sich für weitere Informationen an Ihren Händler zu wenden.
- LG Electronic Deutschland GmbH ist ordnungsgemäß als Hersteller in Deutschland registriert. Damit trägt LG deutschlandweit zur Sammlung von Elektro- und Elektronik-Altgeräten bei, die Sie in kommunalen Getrenntsammlstellen abgeben. Die aktuellsten Informationen finden Sie unter: www.lg.com/global/recycling oder <https://www.lg.com/de/support/altgeraete-rueckgabe>.
 - * Vertrieber mit einer Verkaufsfläche für Elektro- und Elektronikgeräte von mindestens 400 Quadratmetern sowie Vertrieber von Lebensmitteln mit einer Gesamtverkaufsfläche von mindestens 800 Quadratmetern, die Elektro- und Elektronikgeräte anbieten



ΕΛΛΗΝΙΚΑ

Απόρριψη της παλιάς σας συσκευής

- Αυτό το διαγραμμένο σύμβολο του τροχοφόρου κάδου υποδεικνύει ότι τα απόβλητα ηλεκτρικών και ηλεκτρονικών εξοπλισμών (ΑΗΗΕ) πρέπει να απορρίπτονται χωριστά από τα γενικά οικιακά απορρίμματα.
- Τα παλιά ηλεκτρικά προϊόντα μπορεί να περιέχουν επικίνδυνες ουσίες και ως εκ τούτου η σωστή απόρριψη της παλιάς σας συσκευής αποτρέπει ενδεχόμενες αρνητικές συνέπειες για το περιβάλλον και την ανθρώπινη υγεία. Η παλιά σας συσκευή μπορεί να περιέχει επαναχρησιμοποιήσιμα ανταλλακτικά που θα μπορούσαν να χρησιμοποιηθούν για την επισκευή άλλων προϊόντων, καθώς και άλλα υλικά αξίας που μπορούν να ανακυκλωθούν για εξοικονόμηση των περιορισμένων φυσικών πόρων.
- Μπορείτε να πάτε τη συσκευή σας, είτε στο κατάστημα από το οποίο αγοράσατε το προϊόν, ή να επικοινωνήσετε με το τοπικό γραφείο απορριμμάτων για λεπτομέρειες σχετικά με το πλησιέστερο εγκεκριμένο σημείο συλλογής ΑΗΗΕ (Απόβλητα Ηλεκτρικών και Ηλεκτρονικών Εξοπλισμών). Για τις πιο πρόσφατες πληροφορίες για τη χώρα σας επισκεφθείτε τη διεύθυνση www.lg.com/global/recycling

ESPAÑOL

Símbolo para marcar AEE

- El símbolo del contenedor de basura tachado con un aspa indica que la recogida separada de aparatos eléctricos y electrónicos (AEE) debe realizarse de manera separada.

- Los productos eléctricos antiguos pueden contener sustancias peligrosas de modo que la correcta eliminación del antiguo aparato ayudará a evitar posibles consecuencias negativas para el medio ambiente y para la salud humana. El antiguo aparato puede contener piezas reutilizables que podrían utilizarse para reparar otros productos y otros materiales valiosos que pueden reciclarse para conservar los recursos limitados.
- Este producto contiene pilas y/o acumuladores. Siempre que no sea necesaria la intervención de un profesional cualificado para ello, y antes del depósito final del producto en las instalaciones de recogida selectiva, usted debe extraer las pilas y acumuladores de forma segura y separadamente para su adecuada gestión.
- Puede llevar el aparato a cualquiera de los centros autorizados para su recogida. Para obtener la información más actualizada para su país por favor visite www.lg.com/global/recycling

EESTI

Vana seadme hävitamine

- Läbikriipsutatud ristiga prügikasti sümbol tähendab, et elektri- ja elektroonikaseadmete (WEEE) jäätmed tuleb kõrvaldada olmeprügist eraldi.
- Vanad elektriseadmed võivad sisaldada ohtlikke koostisosi, seega aitab prügi nõuetekohane hävitamine vältida võimalikku negatiivset mõju loodusele ja inimeste tervisele. Teie kasutatud seade võib sisaldada taaskasutatavaid osi, millega saab parandada teisi seadmeid ning muid väärtuslikke materjale, mida saab taaskasutada, et säilitada piiratud ressursse.
- Saate viia oma seadme kas kauplusse, kust see on ostetud või võtta ühendust kohaliku prügiveo ettevõttega, et saada lisainfot oma lähima WEEE jäätmete kogumiskoha kohta. Kõige ajakohasemat infot oma riigi kohta vaadake www.lg.com/global/recycling



SUOMI

Vanhan laitteesi hävittäminen

- Tämä yliristitettu jäteastian merkki ilmaisee, että sähkö- ja elektronikkalaitteiden jätteet (WEEE) tulee pitää erillään kotitalousjätteestä ja viedä kunnalliseen kierrätyskeskukseen.
- Vanhat sähkötuotteet voivat pitää sisällään vaarallisia aineita, joten loppuun käytetyn laitteen oikea hävittäminen ehkäisee ympäristö- ja terveyshaittoja. Vanha laitteesi saattaa pitää sisällään uudelleen käytettäviä osia, joita voidaan käyttää korjaamaan muita tuotteita, sekä arvokkaita materiaaleja, joita voidaan kierrättää rajoitettujen resurssien säästämiseksi.
- Voit viedä laitteesi joko liikkeeseen, josta hankit tuotteen, tai ottaa yhteyttä paikallishallintosi ympäristötoimistoon koskien lähintä valtuutettua WEEE -keräyspistettä. Kaikkein viimeisimmät tiedot koskien maatasi, ks. osoitteessa www.lg.com/global/recycling

FRANÇAIS

Recyclage de votre ancien appareil

- Ce symbole de poubelle barrée d'une croix indique que votre équipement électrique et électronique (EEE) ne doit pas être jeté avec les ordures ménagères. Il doit faire l'objet d'un tri et d'une collecte sélective séparée.
- Les équipements électriques que vous jetez peuvent contenir des substances dangereuses. Il est donc important de les jeter de façon appropriée afin d'éviter des impacts négatifs sur l'environnement et la santé humaine. L'équipement que vous jetez peut également contenir des pièces réutilisables pour la réparation d'autres produits ainsi que des matériaux précieux pouvant être recyclés pour préserver les ressources de la planète.

- Vous pouvez rapporter votre appareil au commerçant qui vous l'a vendu ou contacter votre collectivité locale pour connaître les points de collecte de votre EEE. Vous trouverez également des informations à jour concernant votre pays en allant sur www.quefairedemesdechets.fr

HRVATSKI

Zbrinjavanje starog uređaja

- Ovaj simbol prekrizene kante za smeće na kotačićima označava kako se otpadni električni i električni proizvodi (WEEE) moraju zbrinjavati odvojeno od komunalnog otpada.
- Dotrajali električni proizvodi mogu sadržavati opasne tvari stoga će ispravno zbrinjavanje vaših dotrajalih uređaja pomoći u sprječavanju potencijalnih negativnih posljedica na okoliš i ljudsko zdravlje. Vaš dotrajao uređaj može sadržavati dijelove koji se mogu ponovo iskoristiti za popravak drugih proizvoda te druge vrijedne materijale koji se mogu reciklirati i tako sačuvati ograničene resurse.
- Ovisno o razini smetnje / štete i dobi stavke, stari proizvodi mogu se popraviti za više radnog života koji će sprječiti izbjegći otpada. Proizvodi koji nisu prikladni za ponovnu uporabu može se reciklirati da se oporavim vrijedne resurse i pomoći da se smanji globalno potrošnju novih sirovina.
- Uređaj možete odnijeti u trgovinu u kojoj ste kupili proizvod ili možete kontaktirati ured za zbrinjavanje otpada kod vaših mjesnih nadležnih tijela te od njih saznati više informacija o najbližem ovlaštenom WEEE sabirnom centru. Za najnovije informacije iz svoje države pogledajte internetske stranice www.lg.com/global/recycling



MAGYAR

A régi készülék ártalmatlanítása

- A leselejtezett elektromos és elektronikai termékeket a háztartási hulladéktól elkülönítve kell begyűjteni, a jogszabályok által kijelölt módon és helyen.
- Régi készülékeinek megfelelő leselejtezése segíthet megelőzni az esetleges egészségre vagy környezetre ártalmas hatásokat.
- Ha további információra van szüksége régi készülékeinek leselejtezésével kapcsolatban, lépjen kapcsolatba velünk a szelektalok.hu oldalon ahol tájékoztatjuk Önt visszavételi, átvételi, gyűjtési és kezelési kötelezettségeinkről.

ITALIANO

Smaltimento delle apparecchiature obsolete

- Tutte le apparecchiature elettriche ed elettroniche, contrassegnate da questo simbolo ("bidone della spazzatura barrato da una croce"), devono essere raccolte e smaltite separatamente rispetto agli altri rifiuti urbani misti mediante impianti di raccolta specifici installati da enti pubblici o dalle autorità locali. Si ricorda che gli utenti finali domestici possono consegnare gratuitamente le apparecchiature elettriche ed elettroniche a fine vita presso il punto vendita all'atto dell'acquisto di una nuova apparecchiatura equivalente. Gli utenti finali domestici possono inoltre consegnare gratuitamente apparecchiature elettriche ed elettroniche di piccolissime dimensioni (non eccedenti i 25 cm) a fine vita direttamente presso un punto vendita a ciò abilitato, senza obbligo di acquistare una apparecchiatura nuova di tipo equivalente. Si prega di informarsi previamente presso il punto vendita prescelto circa tale ultima modalità di conferimento dell'apparecchiatura a fine vita.

- Il corretto smaltimento dell'unità obsoleta contribuisce a prevenire possibili conseguenze negative sulla salute degli individui e sull'ambiente. Una gestione responsabile del fine vita delle apparecchiature elettriche ed elettroniche da parte degli utenti contribuisce al riutilizzo, al riciclaggio ed al recupero sostenibile dei prodotti obsoleti e dei relativi materiali.
- Per informazioni più dettagliate sullo smaltimento delle apparecchiature obsolete, contattare l'ufficio del comune di residenza, il servizio di smaltimento rifiuti o il punto vendita in cui è stato acquistato il prodotto. (www.lg.com/global/recycling)

LIETUVIŲ

Seno prietaiso utilizavimas

- Išbrauktos šiukšlių dėžės simbolis rodo, kad elektros ir elektronikos įrangos atliekas (EE|A) reiktų utilizuoti atskirai nuo buitinių atliekų.
- Senoje elektrinėje įrangoje gali būti pavojingų medžiagų, taigi tinkamas seno prietaiso utilizavimas padės apsaugoti nuo galimų neigiamų pasekmių aplinkai ir žmonių sveikatai. Jūsų sename prietaise gali būti dalių, kurias galima panaudoti dar kartą taisant kitą įrangą, ir kitų vertingų medžiagų, kurias galima perdirbti siekiant tausoti ribotus išteklius.
- Savo prietaisą galite nugabenti į parduotuvę, kurioje jį įsigijote, arba kreipkitės į vietos valdžios atliekų tarnybą ir sužinokite, kur yra artimiausia EE|A surinkimo vieta. Norėdami gauti daugiau informacijos apie savo šalies reikalavimus, apsilankykite www.lg.com/global/recycling.



LATVIEŠU

Jūsu vecās ierīces likvidēšana

- Šis simbols – pārsvītrotā atkritumu tvertne uz riteņiem – norāda, ka elektrisko un elektronisko iekārtu atkritumi (EEIA) jāutilizē atsevišķi no sadzīves atkritumu plūsmas.
- Veci elektriskie izstrādājumi var saturēt bīstamas vielas, tādēļ jūsu vecās ierīces pareiza utilizācija palīdzēs novērst iespējamās negatīvās sekas videi un cilvēka veselībai. Jūsu vecā ierīce var saturēt vairākkārt izmantojamas detaļas, kuras var izmantot citu izstrādājumu remontam, un citus vērtīgus materiālus, kurus var pārstrādāt, tādējādi saglabājot ierobežotus resursus.
- Jūs varat aiznest ierīci vai nu uz veikalu, kurā šo izstrādājumu iegādājieties, vai sazināties ar vietējās pašvaldības atkritumu savākšanas iestādi un uzzināt sīkāku informāciju par tuvāko oficiālo EEIA savākšanas punktu. Jaunāko informāciju par savu valsti skatiet vietnē www.lg.com/global/recycling.

МАКЕДОНСКИ

Фрлање на вашиот стар апарат

- Сите електрични и електронски производи треба да се фрлат засебно од комуналниот отпад, односно во собирни капацитети назначени од страна на владата или локалните власти.
- Правилното фрлање на вашиот стар апарат ќе помогне да се спречат потенцијални негативni последици за околината и човековото здравје.
- За подетални информации за фрлањето на вашиот стар апарат, ступете во контакт со општинската служба за отстранување отпад или со продавницата од каде што сте го купиле производот.

NEDERLANDS

Verwijdering van uw oude apparaat

- Dit symbool van de doorgekruiste vuilnisbak geeft aan dat afgedankte elektrische en elektronische producten (WEEE) afzonderlijk van het huishoudelijke afval moeten worden verwijderd.
- Oude elektrische producten kunnen gevaarlijke stoffen bevatten, dus een juiste verwijdering van uw oude apparaat helpt bij het voorkomen van mogelijke negatieve gevolgen voor het milieu en de volksgezondheid. Uw oude apparaat kan herbruikbare onderdelen bevatten die kunnen worden gebruikt voor het repareren van andere producten, en andere waardevolle materialen die kunnen worden gerecycled voor het behoud van beperkte grondstoffen.
- U kunt uw apparaat meenemen naar de winkel waar u het product heeft gekocht, of u kunt contact opnemen met uw plaatselijke afvalverwerking instantie voor de gegevens van uw dichtstbijzijnde geautoriseerde WEEE-verzamelpunt. Voor de meest recente informatie voor uw land verwijzen wij u naar www.lg.com/global/recycling

NORSK

Avhending av gamle apparater

- Dette symbolet av en utkrysset avfallsdunk indikerer at kassert elektronikk og elektroniske produkter (WEEE) skal kastes separat fra husholdningsavfall og leveres til den kommunale resirkuleringen.
- Gamle elektriske produkter kan inneholde farlige stoffer, så korrekt avfallshåndtering av det gamle apparatet bidrar til å hindre potensielt negative konsekvenser for miljøet og andres helse. Gamle apparater kan inneholde gjenbrukbare deler som kan brukes til å reparere andre produkter og andre verdifulle materialer som kan resirkuleres for å bevare begrensede ressurser.
- Du kan bringe apparatet enten til butikken der du kjøpte produktet, eller ta kontakt med den lokale myndighetens avfallskontor for informasjon om nærmeste autoriserte innsamlingspunkt for el-avfall (WEEE-avfall). For den mest oppdaterte informasjonen for ditt land, gå til www.lg.com/global/recycling.



POLSKI

Utylizacja starego urządzenia

- Symbol przekreślonego pojemnika na odpady na kółkach oznacza, że produkty elektryczne lub elektroniczne (WEEE) należy zutylizować poza obiegiem odpadów komunalnych.
- Stare produkty elektroniczne mogą zawierać niebezpieczne substancje. Właściwa utylizacja starego urządzenia pozwoli uniknąć potencjalnych negatywnych skutków dla środowiska i zdrowia. Stare urządzenie może zawierać części wielokrotnego użytku, które mogą zostać wykorzystane do naprawy innych produktów lub inne wartościowe materiały, które można przetworzyć, aby oszczędzać zasoby naturalne.
- Urządzenie można oddać do sklepu, w którym zostało kupione lub skontaktować się z lokalnym urzędem gospodarki odpadami, aby uzyskać informacje o najbliższym punkcie zbiórki WEEE. Aby uzyskać aktualne informacje z zakresu gospodarki odpadami obowiązującej w danym kraju, należy odwiedzić stronę <http://www.lg.com/global/sustainability/environment/take-back-recycling/global-network-europe> (plik PDF : "For more information about how to recycle LG products in your country").

PORTUGUÊS

Eliminação do seu aparelho usado

- Este símbolo de um caixote do lixo com rodas e linhas cruzadas sobrepostas indica que os resíduos de produtos elétricos e eletrônicos (REEE) devem ser eliminados separadamente do lixo doméstico.

- Os produtos elétricos usados podem conter substâncias perigosas, pelo que, a eliminação correta do seu aparelho usado pode contribuir para evitar potenciais consequências negativas para o ambiente e saúde humana. O seu aparelho usado pode conter peças reutilizáveis que podem ser usadas para reparar outros produtos e outros materiais úteis que podem ser reciclados para preservar os recursos limitados.
- Pode levar o seu aparelho à loja onde o adquiriu, ou contactar a sua entidade local de recolha e tratamento de resíduos para obter mais informações relativas ao ponto de recolha de REEE autorizado mais próximo. Para obter informações mais atualizadas relativas ao seu país, visite www.lg.com/global/recycling

ROMÂNĂ

Eliminarea aparatului vechi

- Simbolul de peșteră indică faptul că deșeurile de echipamente electrice și electronice (DEEE) trebuie eliminate separat de celelalte deșeuri.
- Produsele electrice și electronice vechi conțin substanțe periculoase. Astfel, prin eliminarea corespunzătoare veți contribui la prevenirea deteriorării mediului înconjurător și al sănătății umane. Este posibil ca dispozitivul dvs. vechi să conțină piese componente care pot fi folosite pentru repararea altor produse sau materiale importante ce pot fi reciclate în scopul economisirii resurselor limitate.
- Dispozitivul vechi poate fi returnat magazinului de unde a fost achiziționat sau puteți contacta firma responsabilă pentru eliminarea deșeurilor în scopul aflării locației unității autorizate pentru reciclarea deșeurilor electrice și electronice (WEEE). Pentru informații mereu actualizate și referitoare la țara dvs. vă rugăm să vizitați pagina web www.lg.com/global/recycling.



SLOVENČINA

Zneškodovanje starého spotrebiča

- Tento symbol prečiarknutého odpadkového koša na koleskach znamená, že odpad z elektrických a elektrónických zariadení (WEEE) musí byť zneškodnený samostatne od komunálneho odpadu.
- Staré elektrické produkty môžu obsahovať nebezpečné latky, preto správne zneškodnenie vášho starého spotrebiča pomôže zabrániť potenciálnym negatívnym dopadom na prostredie a ľudské zdravie. Váš starý spotrebič môže obsahovať diely, ktoré možno opätovne použiť na opravu iných produktov, a iné cenné materiály, ktoré možno recyklovať s cieľom chrániť obmedzené zdroje.
- Svoj spotrebič môžete zaniest' do predajne, kde ste produkt zakúpili, alebo sa môžete obrátiť na oddelenie odpadov miestnej samosprávy a požiadať o informácie o najbližšom zbernom mieste odpadu z elektrických a elektrónických zariadení (WEEE). Najnovšie informácie platné pre vašu krajinu nájdete na stránke www.lg.com/global/recycling

SLOVENŠČINA

Odstranjevanje vaše stare naprave

- Prečrtan simbol smetnjaka opozarja, da je treba odpadne električne in elektronske izdelke (OEEI) odstranjevati ločeno od ostalih komunalnih odpadkov.
- Odpadni električni izdelki lahko vsebujejo nevarne snovi, zato s pravilnim odstranjevanjem stare naprave prispevate k preprečevanju morebitnih negativnih vplivov na okolje in zdravje ljudi. Vaša stara naprava lahko vsebuje dele, ki jih je mogoče uporabiti za popravilo drugih izdelkov, in druge dragocene materiale, ki jih je mogoče reciklirati in s tem ohraniti omejene vire.

- Svojo napravo lahko odnesete v trgovino, kjer ste jo kupili, ali pa se glede podrobnosti o najbližjem pooblaščenem zbirnem mestu za odpadno električno in elektronsko opremo obrnite na lokalno komunalno podjetje. Za najnovejše informacije za svojo državo si oglejte www.lg.com/global/recycling.

SHQIP

Hedhja e pajisjes suaj të vjetër

- Të gjitha produktet elektrike dhe elektronike duhet të hidhen veçmas nga mbetjet e bashkisë përmes pikave të grumbullimit të caktuara nga qeveria ose autoritetet vendase.
- Hedhja e duhur e pajisjes suaj të vjetër do të ndihmojë në parandalimin e pasojave të mundshme negative për mjedisin dhe shëndetin e njeriut.
- Për informacione më të hollësishme rreth hedhjes të pajisjes suaj të vjetër, ju lutem kontaktoni zyrën e qytetit, shërbimin për hedhjen e mbeturinave ose dyqanin ku e keni blerë produktin.



SRPSKI

Odlaganje starog aparata

- Ovaj simbol precrtnana kanta za smeće pokazuje da električni i elektronski otpad (WEEE) treba da se odlaže odvojeno od običnog komunalnog otpada.
- Stari električni aparati mogu da sadrže otrovne supstance, tako da će pravilno odlaganje Vašeg starog aparata pomoći sprečavanju pojave negativnih posledica po životnu sredinu i zdravlje ljudi. Vaš stari aparat može da sadrži delove za višekratnu upotrebu koji se mogu koristiti za zamenu drugih proizvoda i druge vredne materijale koji se mogu reciklirati radi očuvanja ograničenih resursa.
- Vaš aparat možete da odnesete u radnju gde ste ga kupili ili da kontaktirate lokalnu vladinu kancelariju za otpad kako biste dobili informaciju o najbližoj autorizovanoj WEEE stanici za odlaganje ovog otpada. Za najnovije informacije za Vašu zemlju, molimo Vas da pogledate web stranicu www.lg.com/global/recycling.

SVENSKA

Bortskaffning av den gamla produkten

- Den överkorsade soptunnesymbolen indikerar att elektroniskt och elektriskt avfall (WEEE) ska sorteras separat från hushållsavfallet och lämnas in till en av kommunen anvisad plats för återvinning.
- Kasserade elektroniska och elektriska produkter kan innehålla farliga substanser, korrekt avfallshantering av produkten förhindrar negativa konsekvenser för miljön och den mänskliga hälsan. Din gamla produkt kan även innehålla återanvändningsbara delar som kan användas för att reparera andra produkter samt innehålla värdefulla ämnen som kan återvinnas för att spara jordens resurser.
- Du kan ta din gamla produkt till butiken där du köpte den eller kontakta din kommun för information om närmaste WEEE-uppsamlingsställe. För att få den senaste informationen för ditt land, gå till www.lg.com/global/recycling



FR

**Cet appareil
et ses accessoires
se recyclent**

REPRISE
À LA LIVRAISON

OU

À DÉPOSER
EN MAGASIN

OU

À DÉPOSER
EN DÉCHÈTERIE

Points de collecte sur www.quefairedemesdechets.fr
Privilégiez la réparation ou le don de votre appareil !

