



ENGLISH

www.lg.com

Copyright © 2025 LG Electronics Inc.
All Rights Reserved.

LG OLED TV

OWNER'S MANUAL

Safety and Reference

Please read this manual carefully before operating your set and retain it for future reference.

The model and serial number of the product are located on the back and on one side of the product. Record them below in case you ever need service.

Model _____

Serial No. _____



Warning! Safety instructions



CAUTION : TO REDUCE THE RISK OF ELECTRIC SHOCK, DO NOT REMOVE COVER (OR BACK). NO USER-SERVICEABLE PARTS INSIDE. REFER TO QUALIFIED SERVICE PERSONNEL.



This symbol is intended to alert the user to the presence of uninsulated “dangerous voltage” within the product’s enclosure that may be of sufficient magnitude to constitute a risk of electric shock to persons.



This symbol is intended to alert the user to the presence of important operating and maintenance (servicing) instructions in the literature accompanying this apparatus.

WARNING : TO REDUCE THE RISK OF FIRE AND ELECTRIC SHOCK, DO NOT EXPOSE THIS PRODUCT TO RAIN OR MOISTURE.

- TO PREVENT THE SPREAD OF FIRE, KEEP CANDLES OR OTHER ITEMS WITH OPEN FLAMES AWAY FROM THIS PRODUCT AT ALL TIMES.
- **Do not place the product and/or remote control in the following environments:**
 - Keep the product away from direct sunlight.
 - An area with high humidity such as a bathroom.
 - Near any heat source such as stoves and other devices that produce heat.
 - Near kitchen counters or humidifiers where they can easily be exposed to steam or oil.
 - An area exposed to rain or wind.
 - Do not expose to dripping or splashing and do not place objects filled with liquids, such as vases, cups, etc. on or over the apparatus (e.g., on shelves above the unit).
 - Near flammable objects such as gasoline or candles, or expose the product to direct air conditioning.
 - Do not install in excessively dusty places.
 - On unsecured or high furniture, such as shelves or bookshelves.Otherwise, this may result in fire, electric shock, combustion/explosion, malfunction or product deformation.
- **Ventilation**
 - Install your product where there is proper ventilation. Do not install in a confined space such as a bookcase.
 - Do not install the product on a carpet or cushion.
 - Do not block or cover the product with cloth or other materials while unit is plugged in.
- Take care not to touch the ventilation openings. When watching the product for a long period, the ventilation openings may become hot.
- Keep a distance of at least 10 cm away from other objects so that the vents of the Zero Connect Box are not blocked.
 - An increase in the internal temperature of the product may result in fire and product failure.
- Protect the power cord from physical or mechanical abuse, such as being twisted, kinked, pinched, closed in a door, or walked upon. Pay particular attention to plugs, wall outlets, and the point where the cord exits the device.
- Do not move the product whilst the Power cord is plugged in.
- Do not use a damaged or loosely fitting power cord.
- Be sure to grasp the plug when unplugging the power cord. Do not pull on the power cord to unplug the product.
- Do not connect too many devices to the same AC power outlet as this could result in fire or electric shock.
- **Disconnecting the Device from the Main Power**
 - The power plug is the disconnecting device. In case of an emergency, the power plug must remain readily accessible.
- Do not let your children climb or cling onto the product. Otherwise, the product may fall over, which may cause serious injury.
- **Outdoor Antenna Grounding** (Can differ by country):
 - If an outdoor antenna is installed, follow the precautions below.

An outdoor antenna system should not be located in the vicinity of overhead power lines or other electric light or power circuits, or where it can come in contact with such power lines or circuits as death or serious injury can occur.

- Never touch this apparatus or antenna during a lightning storm. You may be electrocuted.
- Make sure the power cord is connected securely to the product and wall socket if not secured damage to the Plug and socket may occur and in extreme cases a fire may break out.
- Do not insert metallic or inflammable objects into the product. If a foreign object is dropped into the product, unplug the power cord and contact the customer service.
- Do not touch the end of the power cord while it is plugged in. You may be electrocuted.
- **If any of the following occur, unplug the product immediately and contact your local customer service.**
 - The product has been damaged.
 - If water or another substance enters the product (like an AC adapter, power cord, or product).
 - If you smell smoke or other odors coming from the product.
 - When lightning storms or when unused for long periods of time.

Even the product is turned off by remote control or button, AC power source is connected to the unit if not unplugged in.
- Do not use high voltage electrical equipment near the product (e.g., a bug zapper). This may result in product malfunction.
- Do not attempt to modify this product in any way without written authorisation from LG Electronics. Accidental fire or electric shock can occur. Contact your local customer service for service or repair. Unauthorised modification could void the user's authority to operate this product.
- Use only an authorised attachments / accessories approved by LG Electronics. Otherwise, this may result in fire, electric shock, malfunction, or product damage.
- Never disassemble the AC adapter or power cord. This may result in fire or electric shock.
- Handle the adapter carefully to avoid dropping or striking it. Do not subject the adaptor to external shock. An impact could damage the adapter.
- To reduce the risk of fire or electrical shock, do not touch the product with wet hands. If the power cord prongs are wet or covered with dust, dry the power plug completely or wipe dust off.
- **Batteries**
 - Store the accessories (battery, etc.) in a safe location out of the reach of children.
 - Do not short circuit, disassemble, or allow the batteries to overheat. Do not dispose of batteries in a fire. Batteries should not be exposed to excessive heat.
 - Caution: Use the correct batteries for the product. Risk of fire or explosion if the battery is replaced by an incorrect type.

- **Moving**

- When moving, make sure the product is turned off, unplugged, and all cables have been removed. It may take 2 or more people to carry larger products. Do not press or put stress on the front panel of the product. Otherwise, this may result in product damage, fire hazard or injury.
- Keep the packing anti-moisture material or vinyl packing out of the reach of children.
- Do not allow an impact shock, any objects to fall into the product, and do not drop anything onto the screen.
- Do not press strongly upon the panel with a hand or a sharp object such as a nail, pencil, or pen, or make a scratch on it. It may cause damage to screen.
- Do not hold the product screen, scratch the surface with a metal object, or apply impact to it.
 - The screen may break, resulting in personal injury or malfunction of the product.
- Do not push or kick the product.
- Do not place heavy objects on top of the product.
- Be careful if you have pets

- **Cleaning**

- When cleaning, unplug the power cord and wipe gently with a soft/dry cloth. Do not spray water or other liquids directly on the product. Do not clean your product with chemicals including glass cleaner, any type of air freshener, insecticide, lubricants, wax (car, industrial), abrasive, thinner, benzene, alcohol etc., which can damage the product and/or its panel. Otherwise, this may result in electric shock or product damage.

Note

Reading the User Guide

The user guide consists of a 'Quick User Guide,' enclosed with your TV purchase, and an 'Electronic User Guide,' stored as a programme on the TV.

Quick User Guide

Contains safety precautions that must be complied with when using the TV, component installation methods, and external device connection methods.

- You can also download or view the Quick User Guide on digital devices such as PCs and mobile phones. Search for the model name in the user guide search bar on the LG Electronics website.
- If you lose or damage the Quick User Guide, call the LG Electronics Customer Centre to request a replacement.

Electronic User Guide

To learn how to use various product features, press the remote control **Q.Settings button** (⊗) and see the Electronic User Guide stored on the TV.

⊗ → [⊗] → [Support] → [User Guide]

- LG Electronics is not responsible for any damage to the product or injuries caused by using non-genuine LG products.
- TV components are subject to change without prior notice for performance upgrades. The model name or design may also be changed according to the circumstances or policies of the manufacturer.
- Images shown in this manual may differ from the actual product.

Separate Purchase

Magic Remote Control: A Magic remote control with smart features such as voice recognition and motion control

Wall mount: A wall mount for fixing the TV screen to the wall

External device connection cable: Cables for connecting external devices such as antennas to the TV

- To make separate purchases, contact the LG Electronics Customer Service Centre.

Before reading this manual

Understanding 60 GHz wireless

- Wireless TVs use 60 GHz radio waves to transmit high-quality video and audio wirelessly.
- The high bandwidth of 60 GHz frequencies is advantageous for large data transmission and has strong linearity but is greatly affected by obstacles.
- For the best TV viewing experience, the transmitting and receiving antennas should face each other, and there should be no obstacles in the transmission path.
- Transmission errors caused by obstacles are not malfunctions. Use the TV after properly installing it according to the recommended installation method.
- This product satisfies the standards for protecting the human body against electromagnetic waves*. (* Meets IEC 62311 standards)

Installing and Using

Examining the Appearance and Component Names of the Wireless TV (TV Screen + Zero Connect Box)

TV Screen

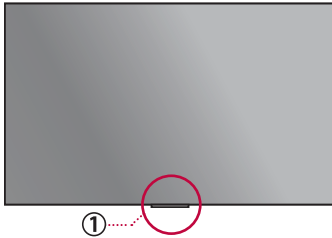

Zero Connect Box (WM25GA)

It is a device that wirelessly transmits video and audio signals to the TV screen by connecting an external antenna or set-top box.

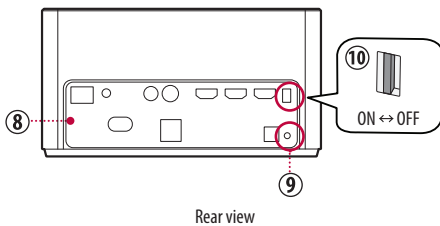
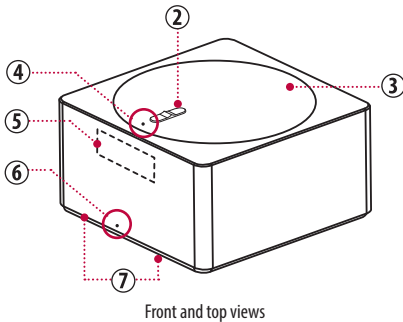

① Wireless signal receiver & Power button

This part receives the video and audio signals sent by the Zero Connect Box. The power button is used to turn the TV screen on, switch to Always Ready mode, and pair with the Zero Connect Box.

② Sliding button

The transmission direction of the Zero Connect Box antenna can be adjusted within a range of 0 to 50° up or down.

③ Dial

The wireless signal transmitter of the Zero Connect Box can be adjusted within a 90° range left or right.

④ Top LED

- Indicates the strength and status of the wireless signal.
- Blue (good), Green (normal), Red blinking (disconnected)
- If the wireless signal is weak, a notification message appears on the screen and the yellow LED lights up.

⑤ Wireless signal transmitter

The part with the antenna that transmits video and audio to the TV screen. The antenna's transmission direction can be adjusted up, down, left, or right using the sliding button and the dial.

⑥ Front LED

Indicates the power or operation status of the Zero Connect Box.

⑦ Voice recognition unit

The part that recognises the user's voice. It may not function properly if this part is blocked or if commands are given from the side or back of the Zero Connect Box.

⑧ External connection terminal

You can connect the Zero Connect Box's power cord and external video/audio devices such as external antennas and set-top boxes.

⑨ Pairing button

The product comes pre-paired, but if the normal screen does not appear, you need to pair it again.

- To re-pair, press the pairing button on the back of the Zero Connect Box for 5 seconds. The top LED flashes white.
- If you press and hold the power button on the TV Screen for 5 seconds, the standby indicator of the screen's power unit flashes white. Once pairing is complete, the top LED on the Zero Connect Box changes to a colour indicating signal strength.
- If pairing is not resumed within one minute, it will be cancelled and must be initiated again.

⑩ Microphone Button

The internal microphone can be turned on or off using the microphone switch.

Note

- Install the product and its stand at least 10 cm away from the ceiling, surrounding walls, and other objects to prevent the blocking of vents.
 - An increase in the internal temperature of the product may result in fire and product failure.
-

Installing the TV Screen

Installing as a stand

(Depending on model)

This method involves setting up the TV screen upright on the floor using a stand.

- Ensure a minimum distance of 10 cm between the TV screen and the ceiling, side walls, and the stand and the rear wall when installing.

Note

- If you pull the TV screen forward, it may fall and lead to damage or injury; therefore, ensure that it is secured to the wall.
- Install the screws on the back of the TV screen and the fixing hooks on the wall at the same level to prevent tilting. Then, use a sturdy strap to tie and secure the screws and fixing hook together. (Fixing hooks, screws, and straps are sold separately.)

Warning

- Do not apply foreign substances (oils, lubricants, etc.) to the screw parts when assembling the product. Doing so may cause damage to the product.
- Ensure that all screws provided are used when assembling the stand, and check that they are tightened fully. Incorrect assembly may cause the TV to tilt or fall, resulting in damage.
- Tightening the screws with excessive force may cause them to come off due to abrasion of the screw joint.

Caution

- Since the TV screen is heavy, at least two people should lift it vertically when unpacking or moving it.
- Do not move while holding the cable holder or cable organisation band. Doing so may damage parts or the TV screen, or may cause injury. (Depending on model)
- Do not forcibly tilt the TV screen. Doing so may cause it to fall and result in damage or injury.
- Take care to avoid getting your hands or fingers caught in the stand and injuring yourself.
- Any damage or injuries caused by using unapproved items are not covered by the manufacturer's warranty.
- If a television is not positioned in a sufficiently stable location, it can be potentially hazardous due to falling. Many injuries, particularly to children, can be avoided by taking simple precautions such as:
 - Using cabinets or stands recommended by the manufacturer of the television.
 - Only using furniture that can safely support the television.
 - Ensuring the television is not overhanging the edge of the supporting furniture.
 - Not placing the television on tall furniture (for example, cupboards or bookcases) without anchoring both the furniture and the television to a suitable support.
 - Not standing the televisions on cloth or other materials placed between the television and supporting furniture.
 - Educating children about the dangers of climbing on furniture to reach the television or its controls.

Installing as a wall mount

This method involves installing the TV screen horizontally on the wall using a wall mount. Refer to the wall-mounting bracket guide provided separately for detailed information.

- To install the support, ensure that the wall is made of a material that can endure the weight of the TV Screen, such as concrete, natural stone, or masonry brick.
- Leave sufficient space around the product so that the ventilation vents of the TV screen are not blocked.

Note

- In the case of adhesive wall mounts, the TV screen may not adhere to the wall, depending on the condition of the wall.
- LG wall mount products are recommended. If you use a wall mount not provided by LG, ensure that it provides sufficient distance from the wall.
- When using a fixed wall mount, connect the cables before installing the TV screen.
- You can organise the TV screen power cord using the dedicated cable management.

Caution

- When installing the TV screen, ensure that you wear work gloves. Installing with unprotected hands may result in injury.
- If you installed your TV screen with an adhesive wall mount, ensure that it is used only when adhered to the wall. The TV screen may wobble or tilt, causing damage.
- Do not install the wall mount in a place where it may come into contact with oil or oil vapour. Doing so may damage the TV screen.

Installing Zero Connect Box

1. Choosing the Installation Location

The Zero Connect Box can be installed in front, beside, or below the TV screen. Follow the user guide for proper installation.

- Do not place obstacles between the TV Screen and Zero Connect Box. Doing so may interfere with wireless signal transmission and voice recognition functions.
- Install the Zero Connect Box lower than the wireless signal receiver of the TV screen.
- The transmission range of the Zero Connect Box varies depending on the direction in which it faces the TV screen. Refer to the figure below and install it within the appropriate distance.

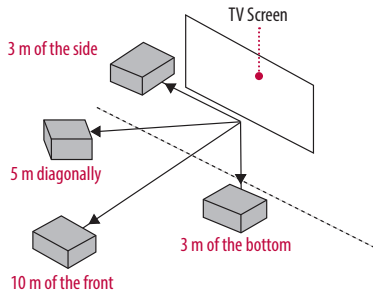

Note

- Do not install two wireless TVs or Zero Connect Boxes in the same room. They may interfere with one another.
- Do not place electronic devices or objects on top of the Zero Connect Box. Doing so may cause interference in transmission, resulting in screen display failure.
- When using a sound bar, ensure that it does not obstruct the wireless signal receiver of the TV screen.

2. Adjusting the Reception Direction (Left/Right & Up/Down)

Dial

If the front LED of the Zero Connect Box is not facing the TV screen wireless signal receiver, you can adjust the wireless signal transmission direction of the Zero Connect Box from 0° to 90° left and right by turning the dial.

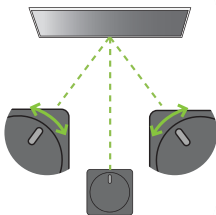

Sliding button

If the wireless signal transmission direction of the Zero Connect Box is not toward the wireless signal receiver of the TV screen, you can adjust the wireless signal transmission direction from 0° to 50° up and down by adjusting the sliding button.

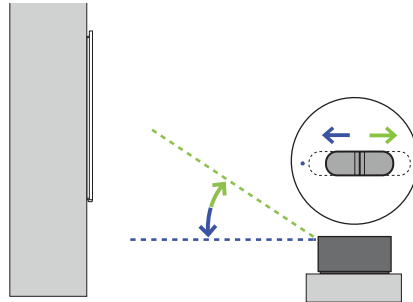

3. Checking Wireless Signal Strength

After completing the basic placement and settings, turn on the TV and check the signal strength through the colour of the top LED of the Zero Connect Box. The colours are blue (good), green (moderate), and red (disconnected).

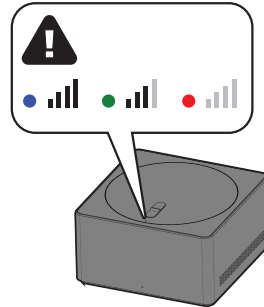

Note

- If the top LED turns red, check for obstacles in the transmission path and ensure that the product is installed properly in the correct location.
- If the top LED is green, use the dial and sliding button to verify that the reception direction of the Zero Connect Box is correctly set.
- The screen may not display after cleaning or moving the product as the installation environment may have changed. Check the colour of the top LED of the Zero Connect Box and adjust accordingly.

Recommended installation methods

⚠ Caution

- The device should be positioned and operated with a minimum distance of 20 cm from human body.

When Installing in a Straight Line in Front of the TV Screen

1. Before turning on the TV, ensure that the front LED of the Zero Connect Box is facing the **wireless signal receiver of the TV screen**.
2. If the front LED is not facing the wireless signal receiver of the TV screen, turn the dial on the top of the Zero Connect Box left or right to adjust the direction of the sliding button to face the wireless signal receiver.
3. Adjust the sliding button on the Zero Connect Box **towards the top LED**.
 - Once the dial and sliding button adjustments are completed, the signal transmission and reception path should be in the green direction shown in the figure.
4. After turning on the TV, check if the top LED colour of the Zero Connect Box is blue.
 - If the LED is not blue, adjust the dial and sliding button further to optimise the signal condition.
 - Ensure that there are no obstacles in the antenna transmission path.
 - Install the Zero Connect Box within 10 m of the TV screen. (provided that there are no obstacles in the way.)
 - The signal transmission angle of the Zero Connect Box is 45° left and right. If your TV screen is outside 45°, please refer to the diagonal or side mounting method.

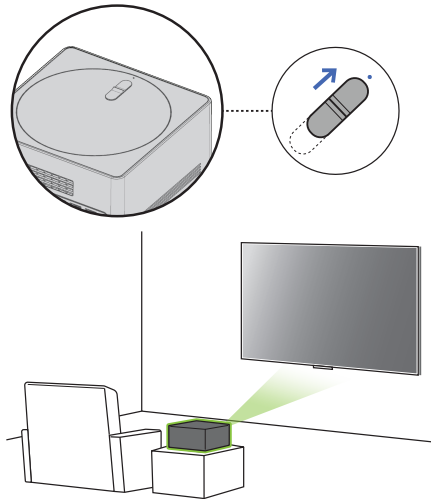

When Installing Diagonally in Front of the TV Screen

1. Before turning on the TV, ensure that the front LED of the Zero Connect Box is facing the **wireless signal receiver of the TV screen**.
2. If the front LED is not facing the wireless signal receiver of the TV screen, turn the dial on the top of the Zero Connect Box left or right to adjust the direction of the sliding button to face the wireless signal receiver.
3. Adjust the sliding button on the Zero Connect Box **towards the top LED**.
 - Once the dial and sliding button adjustments are completed, the signal transmission and reception path should be in the green direction shown in the figure.
4. After turning on the TV, check if the top LED colour of the Zero Connect Box is blue.
 - If the LED is not blue, adjust the dial and sliding button further to optimise the signal condition.
 - Ensure that there are no obstacles in the antenna transmission path.
 - Install the Zero Connect Box within 5 m of the TV screen. (provided that there are no obstacles in the way.)

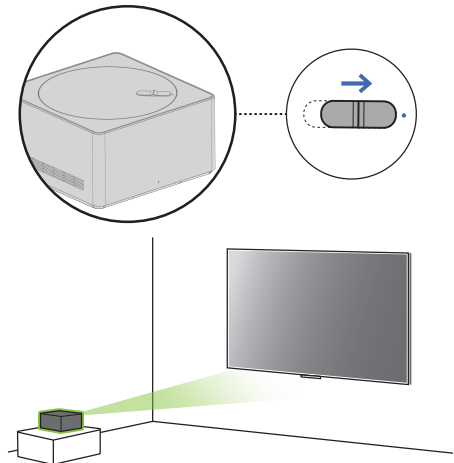

When Installing Beside the TV Screen

1. Before turning on the TV, ensure that the front LED of the Zero Connect Box is facing the **wireless signal receiver of the TV screen**.
2. If the front LED is not facing the wireless signal receiver of the TV screen, turn the dial on the top of the Zero Connect Box left or right to adjust the direction of the sliding button to face the wireless signal receiver.
 - If the front LED of the Zero Connect Box faces the viewing direction, turn the dial left or right until it is at a 90° angle.
3. Adjust the sliding button on the Zero Connect Box to the **centre**.
 - Once the dial and sliding button adjustments are completed, the signal transmission and reception path should be in the green direction shown in the figure.
4. After turning on the TV, check if the top LED colour of the Zero Connect Box is blue.
 - If the LED is not blue, adjust the dial and sliding button further to optimise the signal condition.
 - Ensure that there are no obstacles in the antenna transmission path.
 - Install the Zero Connect Box within 3 m of the TV screen. (provided that there are no obstacles in the way.)

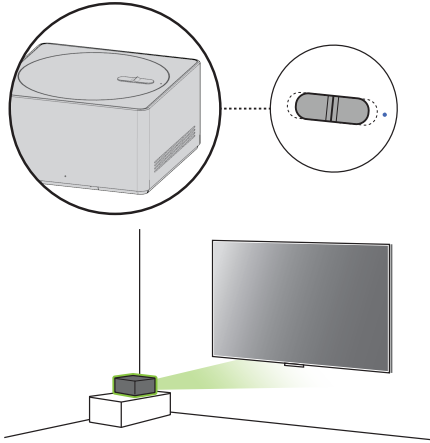

When Installing Below the TV Screen

1. Before turning on the TV, ensure that the front LED of the Zero Connect Box is aimed at **the viewer facing the TV screen**.
2. Turn the dial on the top of the Zero Connect Box left or right to adjust the direction of the sliding button towards the viewer.
3. Adjust the sliding button on the Zero Connect Box in the **opposite direction of the top LED**.
 - Once the dial and sliding button adjustments are completed, the signal transmission and reception path should be in the green direction shown in the figure.
4. After turning on the TV, check if the top LED colour of the Zero Connect Box is blue.
 - If the LED is not blue, adjust the dial and sliding button further to optimise the signal condition.
 - Ensure that there are no obstacles in the antenna transmission path.
 - Install the Zero Connect Box within 3 m of the TV screen. (provided that there are no obstacles in the way.)
 - When installing the Zero Connect Box at the bottom of the TV screen, please do so within the area indicated in the figure.

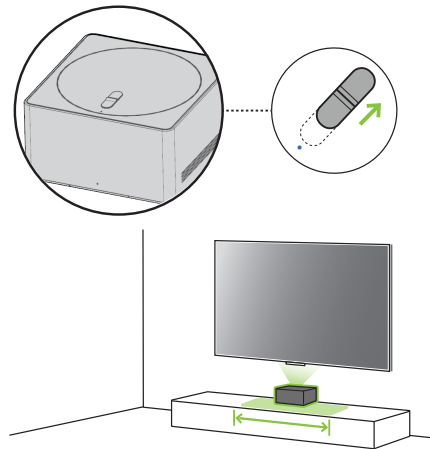

Connecting External Terminals

You can connect external devices such as cables, HDMI, and set-top boxes to the TV. For more information on external device's connection, refer to the manual provided with each device.

- When used with an external device using a 60 GHz frequency, the screen may fail to display due to mutual interference.
- Set the appropriate resolution and frequency for the connected device. Failure to do so may cause straining of the eyes.
- The detailed installation method may vary depending on the TV model.

Installing Antenna/Cable

- Insert the coaxial cable that transmits audio/video signals into the antenna/cable input terminal or antenna input terminal on the back of the Zero Connect Box.
- Be careful not to bend the copper wire when connecting the coaxial cable.
- Use a signal amplifier if the signal is weak.
- When using one antenna for two or more TVs, use a signal splitter.

Note

- Do not apply oil or lubricant to the screws used during installation. Doing so may cause the TV to malfunction.
-

Satellite dish

Connect the TV to a satellite dish to a satellite socket with a satellite RF cable (75 Ω). (Depending on model)

HDMI

- Use an HDMI certified cable (less than 3 m) with the HDMI logo (Ultra High Speed HDMI®/™ cable).
- Turn off the power of the TV and all connected devices, and unplug them from the socket before connecting the HDMI cable.
- Connecting a device that supports the HDMI Ultra HD Deep Colour feature to the TV will provide a clearer image. If you connect a device that does not support this feature and enable the feature, it may not work properly. If problems arise, change the settings.

Note

- HDMI audio support formats may vary depending on the TV model.
 - HDMI devices should have bezels less than 10 mm thick and 18 mm width.
-

USB / USB Hub

If the USB hub connected to the TV does not recognise USB devices, connect the USB directly to the TV terminal.

Note

- If the shapes of the TV terminal and the USB device do not match, use an extension cable that supports USB 2.0.
 - USB devices should have bezels less than 10 mm thick and 18 mm width.
-

IR Blaster

This is an infrared transmitter that allows smoother control of devices such as set-top boxes, Blu-ray players, DVD players, sound bars, and gaming consoles.

- If the Zero Connect Box is installed in a location other than the bottom of the TV, external devices may not be controlled smoothly with the TV remote control; therefore, connecting an IR blaster is recommended.
- Controlling the IR blaster requires an integrated remote control setting.
- Secure both ends of the IR blaster to the front (receiver) of the external device remote control using the tape provided.

Wired LAN

- When connecting to a wired LAN, use a CAT 7 cable with high-speed Internet transmission. (Only when LAN port is provided.)
- TV audio can be transmitted to the sound bar (external audio device). When transmitting via wired methods (optical digital, HDMI ARC), connect to the rear external terminal of the Zero Connect Box, and when transmitting wirelessly (LG soundbar supporting the WOWCAST feature), use the WOWCAST feature. (Depending on country)

Using the TV

Using the power button

Press the **power button** (⏻) located on the bottom of the TV briefly to turn the screen on and hold it to turn off all functions and the screen.

- Only use the power button when the TV screen and the Zero Connect Box are connected.
- The shape and location of the power button may vary depending on the TV model.
- When you turn on the power for the first time after purchasing the product, it may take about 1 minute for the screen to turn on due to initialisation.
- For models with motion sensors if you set screen on with the motion sensor, the TV will turn on by recognising the motion. (Depending on model)

Using hands-free voice control

- To use hands-free voice control, ensure that the front LED of the Zero Connect Box is facing the user, and turn the dial left or right so that the sliding button points towards the wireless receiver of the TV screen.
- Press the remote control **Q.Settings button** (⊗) to turn on hands-free voice control. The feature settings path may vary depending on the TV model.

⊗ → [⊗] → [General] → [AI Service] → [Voice Recognition Settings] → [Use Hands-free Voice Control]

Managing

Protecting the OLED TV Screen

- Unlike general LED/LCD TVs, OLED TVs can display perfect black and produce clear images without light blurring.
- Due to the characteristics of OLED materials that provide high-resolution display, image retention may occur or persist, leaving an afterimage on the screen.
- Image retention is a common phenomenon in all OLED panels. Using the recommended viewing mode can minimise image retention.
- Avoid displaying images that are likely to cause image retention, and follow the recommendations.

Images that are likely to cause image retention

- Screen with black areas on one or more sides on the top, bottom, left or right
- Images whose aspect ratio is 4:3 or 21:9.
- Screens with images fixed for a long time, such as channel numbers, broadcast station logos, game console icons, or set-top box menus
- Other static screens or screens that repeat the same scene

Recommendations for Minimising Image Retention

- When watching TV for extended periods, press the remote control **Q.Settings button** (Ⓚ) and configure the screen as follows.
 1. Ⓚ → [Ⓚ] → [Picture] → [Select Mode] → [Eco] / [Auto Power Save] (Depending on country)
 2. Ⓚ → [Ⓚ] → [Picture] → [Advanced Settings] → [Brightness] → [OLED Pixel Brightness] → Adjusting to Low
 3. Ⓚ → [Ⓚ] → [General] → [OLED Care] → [OLED Panel Care] → [Adjust Logo Brightness] → [High]
- If there are black areas on one or more of the top, bottom, left, or right sides of the screen, press the remote control **Q.Settings button** (Ⓚ) to remove the black areas before watching.
- Ⓚ → [Ⓚ] → [Picture] → [Aspect Ratio] → [User Selection] → [Vertical Zoom] or [4-Way Zoom]
- Turn off the menu for setting up external devices such as set-top boxes so that it is not displayed on the screen for a prolonged period.

Note

- OLED TVs automatically lower screen brightness when a fixed image is received for an extended period and restore brightness once the fixed image is gone.
 - This is one of the features of the TV for minimising image retention and is not a malfunction.
-

Running Pixel Cleaning



OLED TVs are equipped with a pixel cleaning feature that detects screen conditions on its own to prevent retention.

- Pixel cleaning automatically calculates the optimal execution time based on cumulative viewing time and runs automatically when you turn off the TV.
- Horizontal lines may appear at the top and bottom of the screen during pixel cleaning.
- The pixel cleaning feature works when the TV is connected to the power cord and main power.
- Pixel cleaning can also be run manually by pressing the remote control **Q.Settings button** (Ⓚ).
- Ⓚ → [Ⓚ] → [General] → [OLED Care] → [OLED Panel Care] → [Pixel Cleaning]

Troubleshooting

- If you notice any of the problems below while using the product, please check again. It may not be a fault.
- Before contacting the LG Electronics Service Centre, press the  button on the remote control three times in TV/HDMI input mode to check the product model name and serial number. You will be able to receive faster assistance.

Power and Screen

<p>The product does not turn on.</p>	<p>» Is the power cord plugged in properly? Check if the power cord is plugged properly into the product and socket.</p> <p>» Is there a problem with the socket? Plug the power plug of another device into the socket where the product was plugged in to check if the socket is functioning properly.</p>
<p>The product turns off suddenly.</p>	<p>» Is the sleep timer set?  →  → [General] → [System] → [Time & Timer] → [Timers] → Set [Sleep Timer] / [Power Off Timer] to [Off] / [Off].</p> <p>» Check if the external devices are working together. Stop using the external devices you are using together and check if the TV is working normally.</p> <p>» Did the auto-off feature work? This product is equipped with an auto-off function that automatically turns off the power if the remote control is not used for 15 minutes without an input signal.</p>
<p>Dots on the screen.</p>	<p>» Do you see white dots, bright dots, dark dots, or flickering dots on the screen? This product is an advanced product containing millions of pixels. You may see flickering dots of about 1/1,000,000 (1 PPM). These are not considered product defects or malfunctions.</p> <ul style="list-style-type: none"> • White Dots: dots that appear bright, • Bright Dots: dots that appear brighter than normal image • Dark Dots: dots which part of a letter or an object is invisible or blurry • Flickering Dots: Dots that flicker

Zero Connect Box Connection

<p>A power connection image appears on the screen.</p>	<p>» Is the Zero Connect Box connected properly? Ensure that the Zero Connect Box power cord is plugged firmly into the socket.</p>
<p>A Zero Connect Box connection image appears on the screen.</p>	<p>» Are there any objects interfering with the wireless signal transmission? Clear any objects between the TV screen and the Zero Connect Box.</p> <p>» Is the wireless signal from the Zero Connect Box properly oriented? Adjust the dial and sliding box on top of the Zero Connect Box according to the recommended installation method for each location of the Zero Connect Box.</p>

Hands-free Voice Control

Voice recognition is not working well.

- » **Is the Hands-free Voice Control feature turned on?**
⊗ → [⊗] → [General] → [AI Service] → [Voice Recognition Settings] → Set [Use Hands-free Voice Control] to On. (Depending on model)
 - » **Is the front of the Zero Connect Box facing the user?**
Install the Zero Connect Box with its front facing the user, and rotate the dial left and right to adjust the direction of the sliding button towards the wireless signal receiver of the TV screen.
-

Motion Detection

In Always Ready mode, the motion sensor activates unnecessarily or fails to activate.

(Depending on model)

- » **Is the motion sensor clean?**
The motion sensor is located at the bottom centre of the TV screen and may not function properly if covered with foreign substances. Wipe it clean with a soft cloth.
 - » **Is the surrounding area too bright or too dark?**
Maintain a suitable brightness level in the area where the product is installed.
 - » **Is there an object interfering with the motion sensor detection?**
Clear any objects in front of the TV screen.
 - » **Is the motion sensor too sensitive or insensitive?**
The motion sensor can activate when detecting changes in lighting, movements of pets, robot vacuum cleaners, and other objects as they are recognised as motions. ⊗ → [⊗] → [General] → [Always Ready] → Select [Enable the function], turn off the screen, and then stop using the motion sensor or adjust its sensitivity in [Options].
-

Noise

There is noise coming from the product.

- » **Do you hear a "ticking" sound?**
This is the sound of the plastic deforming due to temperature and humidity. It is a common phenomenon in plastic products like furniture and cars; therefore, it is not a cause for concern.
 - » **Is the noise related to electricity?**
The sound is caused by the high-speed switching circuit that supplies current to the product, and it does not affect the functionality of the product.
 - » **Do you hear the fan noise from the Zero Connect Box?**
This is a normal sound created to dissipate heat generated inside the product.
* LG Electronics manages product production with strict standards, and noise below a certain level is not considered a product defect or malfunction.
-

Magic Remote Control

The remote control is not working.

- » **Is there a connection problem with the product?**
Press and hold the ⊕ button and ⊗ button in the middle of the Magic remote control simultaneously for more than 5 seconds to re-register.
 - » **Are there any objects interfering with the wireless signal transmission?**
Clear any objects between the TV screen and the remote control.
 - » **Are the batteries inserted correctly?**
Ensure that the ⊕ side and ⊖ side of the battery are in the correct position. Replace both batteries with new ones when they run out.
-

Other

If any of the following issues occur, turn off the product, unplug the power plug from the socket and contact the LG Electronics Service Centre for inspection. Do not repair the product yourself.

- If the product fails to display images or produce sound, even when the power is turned on
 - If the product continues to display images or produce sound, even when the power is turned off
 - If there is smoke or a burning smell coming from the product
 - If water or a foreign substance gets into the product
 - If the screen image appears to be cut off
 - If the product makes repetitive sounds, such as a "buzzing" or "cracking" noise
 - If there is any other problem or malfunction with the product
-

Product information

Broadcasting Specifications (Depending on country)	Television system	Terrestrial / Cable / Satellites Digital TV
	External antenna impedance	75 Ω
Environment Condition	Operating Temperature	0 °C to 40 °C
	Operating Humidity	Less than 80 %
	Storage Temperature	-20 °C to 60 °C
	Storage Humidity	Less than 85 %
Conditions for Wall Mount Installation	Tilt Angle	0° - 15° (This specification applies only to products with an adjustable wall mount angle.)
Wireless Reception Conditions	Distance	3 - 10 m (Only under conditions with no obstacles)
Power requirement		AC 100-240 V~ 50/60 Hz

- The energy information provided with the product is indicated in accordance with the regulations of each country. (Depending on country)
 - The Energy consumption is measured in accordance with IEC 62087.
- Actual Energy consumption may vary depending on factors such as the type of video content being played and TV settings.
- For information of the power supply and power consumption, refer to the label attached to the product. (Depending on country)
 - The typical power consumption is measured in accordance with IEC 62087 or each country's energy regulations.
 - See the label on the bottom of the product for power source, power ratings and product information.
 - * On some models, the label is inside the external device connection terminal cover.
 - * Depending on the model or country, the typical power consumption may not be on label.

Open Source Software Notice Information

To obtain the source code that is contained in this product, under GPL, LGPL, MPL, and other open source licenses that have the obligation to disclose source code, and to access all referred license terms, copyright notices and other relevant documents please visit <https://opensource.lge.com>.

LG Electronics will also provide open source code to you on CD-ROM for a charge covering the cost of performing such distribution (such as the cost of media, shipping, and handling) upon email request to opensource@lge.com.

This offer is valid to anyone in receipt of this information for a period of three years after our last shipment of this product.

Licenses

HDMI™

HIGH-DEFINITION MULTIMEDIA INTERFACE

QUICKSET®

(Magic Remote supported models only)

HEVC Advance™

Covered by patents at patentlist.accessadvance.com

Regulatory







WARNING! (STABILITY HAZARD)

A television set may fall, causing serious personal injury or death. Many injuries, particularly to children, can be avoided by taking simple precautions such as:

- ALWAYS use cabinets or stands or mounting methods recommended by the manufacturer of the television set.
- ALWAYS use furniture that can safely support the television set.
- ALWAYS ensure the television set is not overhanging the edge of the supporting furniture.
- ALWAYS educate children about the dangers of climbing on furniture to reach the television set or its controls.
- ALWAYS route cords and cables connected to your television so they cannot be tripped over, pulled or grabbed.
- NEVER place a television set in an unstable location.
- NEVER place the television set on tall furniture (for example, cupboards or bookcases) without anchoring both the furniture and the television set to a suitable support.
- NEVER place the television set on cloth or other materials that may be located between the television set and supporting furniture.
- NEVER place items that might tempt children to climb, such as toys and remote controls, on the top of the television or furniture on which the television is placed.

If the existing television set is going to be retained and relocated, the same considerations as above should be applied.

Symbols

	Refers to alternating current (AC).
	Refers to direct current (DC).
	Refers to class II equipment.
	Refers to stand-by.
	Refers to "ON" (power).
	Refers to dangerous voltage.

(Australia region only)



Freeview Plus provides access to content and services from the Freeview networks. The Freeview Plus service provides a 7 + day EPG, all available Catch Up TV, recommendations and the ability to set reminders and favourites. Freeview Plus is available by pressing the green button on the remote.

* Freeview Plus uses HbbTV technology which combines broadcast and broadband. It requires an internet connection. Normal data usage charges and conditions apply.

(Australia and New Zealand region only)

















The use of the 5,150 – 5,350 MHz and 5,945 – 6,425 MHz band (if applicable) is restricted to indoor use only. This restriction exists in the countries Australia (AU) and New Zealand (NZ).

(For Wi-Fi/Bluetooth built-in model or Wi-Fi built-in model)









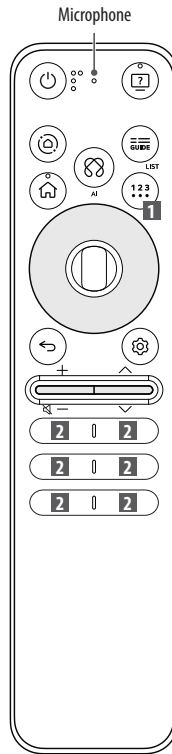







"RF Radiation Exposure Statement

This equipment shall be installed and used at a minimum distance of 20 cm from the human body."

Using Magic Remote Control

-  **Power** Turns the TV on or off.
-  **Home Hub** Accesses the [Home Hub].
-  **Home Hub** Changes the input source.
-  **Home** Accesses the Home menu.
-  **Home** The screen zoom function is activated.
-  **Wheel (OK)** Press the centre of  button to select a menu. You can change programmes by using  button.
-  **Up/Down/Left/Right** Press the up, down, left or right button to scroll the menu. If you press  buttons while the pointer is in use, the pointer will disappear from the screen and Magic Remote will operate like a general remote control. To display the pointer on the screen again, shake Magic Remote to the left and right.
-  **Back** Returns to the previous level.
-  **Back** The screen displayed on the TV is closed and the home menu appears.
-  **Volume buttons** Adjusts the volume level.
-  **Volume buttons** Mutes all sounds.



-  **Accessibility** Accesses the [Accessibility] app.
-  **Accessibility** Accesses the [Accessibility Shortcuts].
-  **GUIDE** Accesses the [Guide].
-  **LIST** ^{**} Accesses the saved programmes list.
-  **AI** Network connection is required to use the voice recognition function. Check for recommended content. (Some recommended services may not be available in some countries.)
-  **AI** Speak while pressing and holding the button to use the voice recognition feature.
-  **More actions** Displays more remote control functions.
-  **1 AD/SAP** ^{**} Audio descriptions function will be enabled.
-  **Q. Settings** Accesses the Quick Settings.
-  **Q. Settings** Displays the All Settings menu.
-  **Programme buttons** Scrolls through the saved programmes.
-  **Various services button** Connects to various services such as streaming and voice search.
-  **Volume buttons** Mutes all sounds.
-  **User Guide** Accesses the [User Guide].
-  **2 ☆ FAV** ^{**} Accesses your favorite programmes list.
-  **2 ▷||** **Control buttons** Controls media contents.

 **Note**

**** To use the button, press and hold for more than 1 second.**



Power Turns the TV on or off.



GUIDE Accesses the [Guide].

— (Dash) Inserts a — between numbers such as 2-1 and 2-2.



LIST ** Accesses the saved programmes list.

Accesses the [Edit Quick Access].

- [Edit Quick Access] is a feature that allows you to enter a specified app or Live TV directly by pressing and holding the number buttons.



Volume buttons Adjusts the volume level.



Home Accesses the Home menu.



Home The screen zoom function is activated.



Wheel (OK) Press the centre of button to select a menu. You can change programmes by using button.



Up/Down/Left/Right Press the up, down, left or right button to scroll the menu. If you press buttons while the pointer is in use, the pointer will disappear from the screen and Magic Remote will operate like a general remote control. To display the pointer on the screen again, shake Magic Remote to the left and right.



Back Returns to the previous level.



Back The screen displayed on the TV is closed and the home menu appears.

Microphone

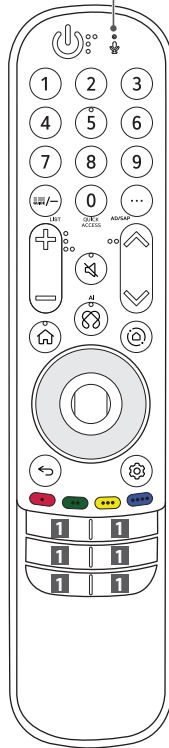

AD/SAP **



Number buttons Enters numbers.

Accesses the [Quick Help].

More actions Displays more remote control functions.

Audio descriptions function will be enabled.

Programme buttons Scrolls through the saved programmes.

Mute Mutes all sounds.

Mute Accesses the [Accessibility Shortcuts] app.

AI Network connection is required to use the voice recognition function.

Check for recommended content. (Some recommended services may not be available in some countries.)

AI Speak while pressing and holding the button to use the voice recognition feature.

Home Hub Accesses the [Home Hub].

Home Hub Changes the input source.

Q. Settings Accesses the Quick Settings.

Q. Settings Displays the All Settings menu.

These access special functions in some menus.

Red button Runs the record function.

Various services button Connects to various services such as streaming and voice search.

The descriptions in this manual are based on the buttons on the remote control. Please read this manual carefully and use the TV correctly. (Some buttons and services may not be provided depending on models or regions.)

How to register the Magic Remote Control

To use the Magic Remote, first pair it with your TV.

1. Put batteries into the Magic Remote and turn the TV on.
 2. Point the Magic Remote at your TV and press the  **Wheel (OK)** on the remote control.
- * If the TV fails to register the Magic Remote, try again after turning the TV off and back on.

How to deregister the Magic Remote Control

Press the  **(Back)** and  **(Home)** buttons at the same time, for five seconds, to unpair the Magic Remote with your TV.

- * Press and hold the  **(Home)** and  **(Q. Settings)** buttons for more than 5 seconds to disconnect and re-register the Magic Remote at the same time.













- It is recommended that an Access Point (AP) be located more than 0.2 m away from the TV. If the AP is installed closer than 0.2 m, the Magic remote control may not perform as expected due to frequency interference.



Using Always Ready

(Depending on model)

You can operate the TV and connect to Bluetooth with direct voice recognition while the power is off.

- *  →  → [General] → [Always Ready], setting [Enable the function] to on.
- * Pressing the   button while watching TV switches the screen to [Always Ready] that is turned on, and pressing the   button once more turns the screen to [Always Ready] that is turned off.
- * Press the  **(Home)** button or the  **(Back)** button to watch TV when the screen is in [Always Ready] that is turned on.
- * Press the  **Wheel (OK)** button to display the wallpaper when the screen is in [Always Ready] that is turned off, and press the   button to watch TV.

✔ Note

- Using Always Ready may increase energy consumption.
- For more information about the feature, refer to the  →  → [Support] → [User Guide] → [Troubleshooting] → [Learn More About Always Ready].

Regulatory

Singapore

Complies with
IMDA Standards
DB102260

South Africa

