

UP81*

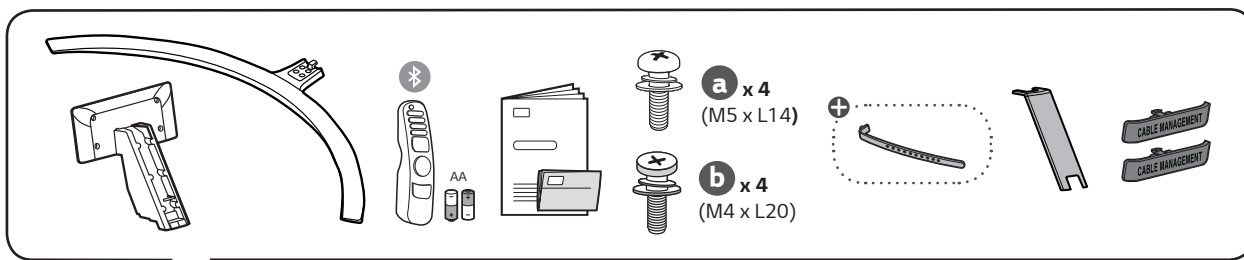

1

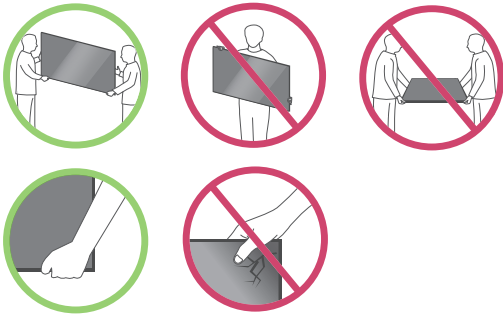
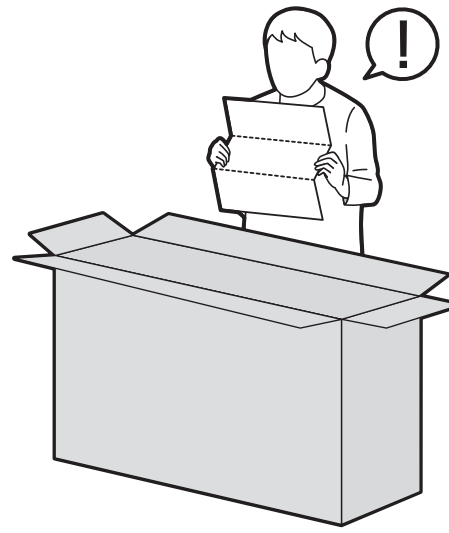
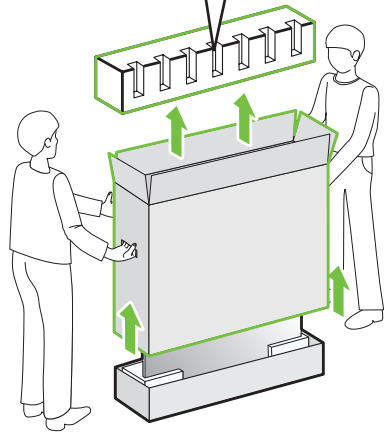

2

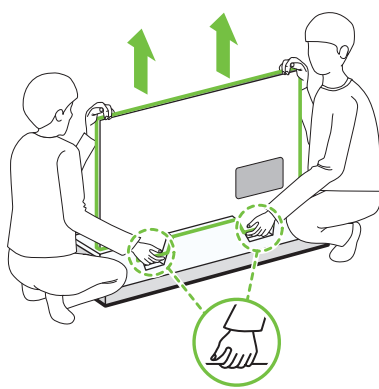

3

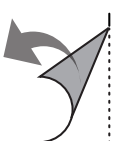
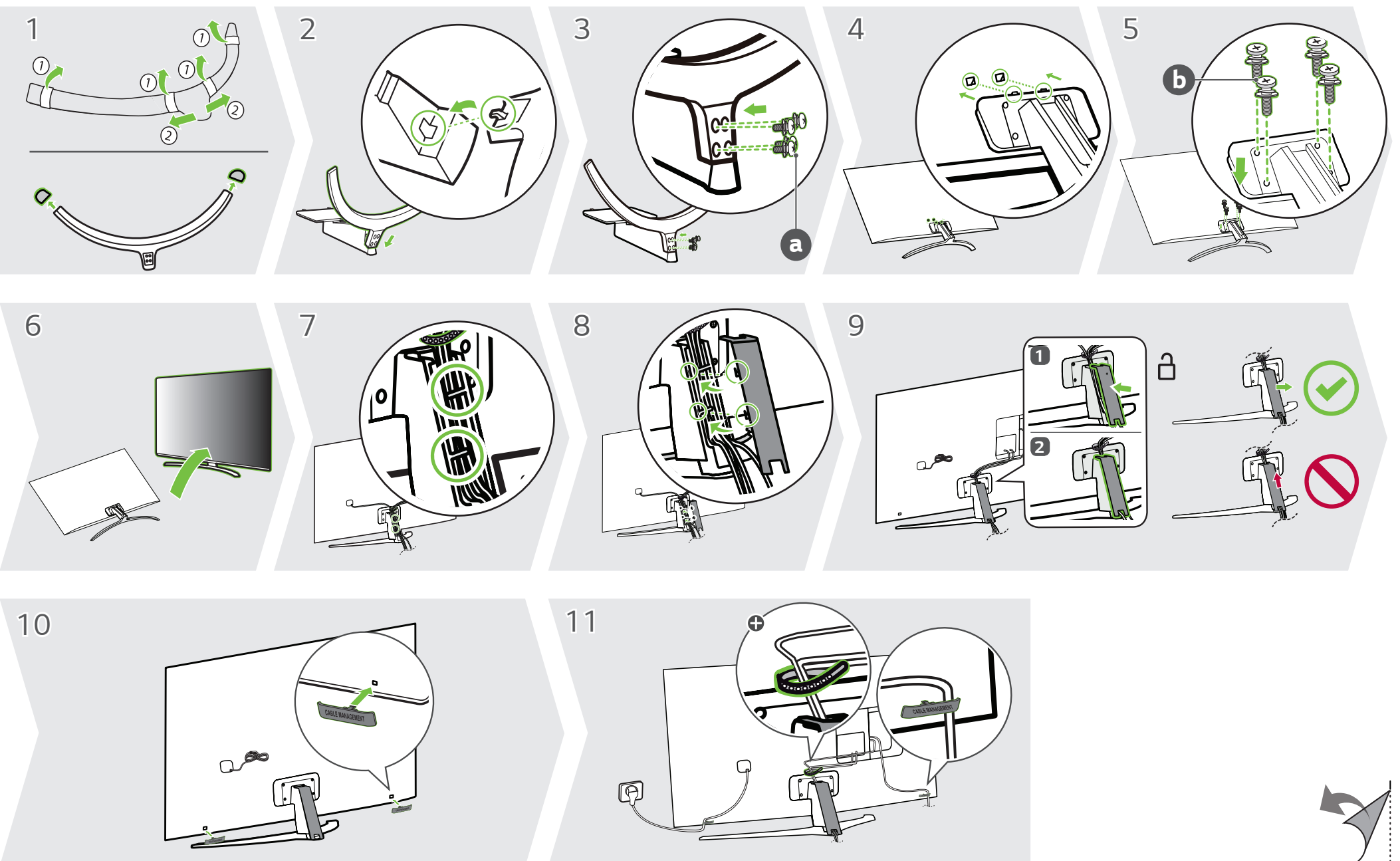
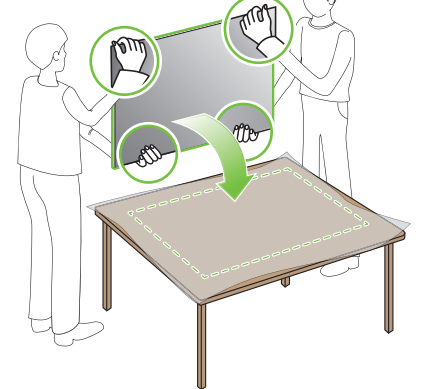

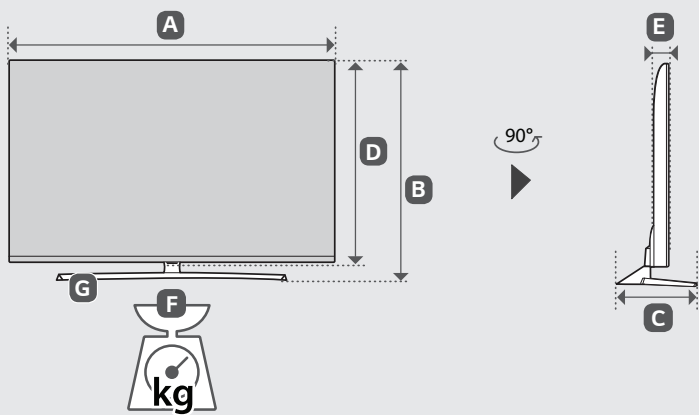
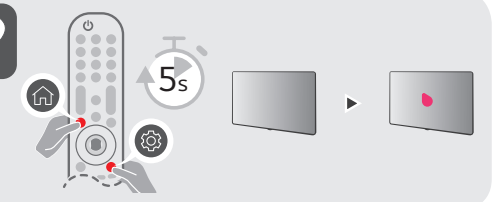
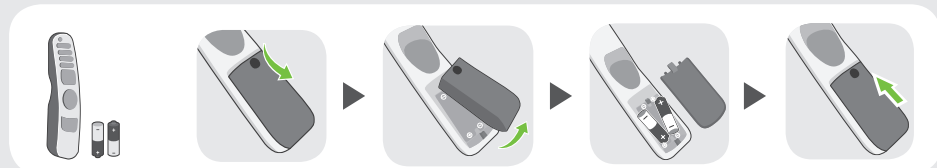
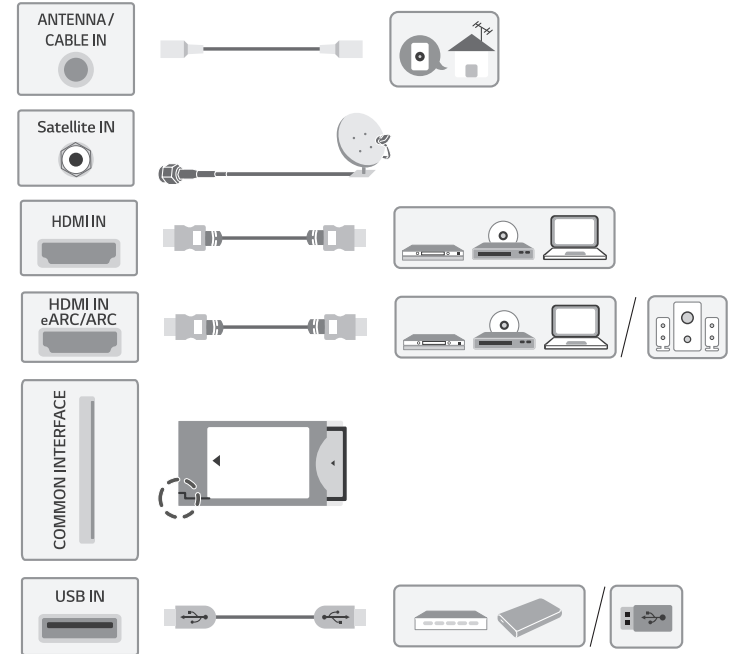
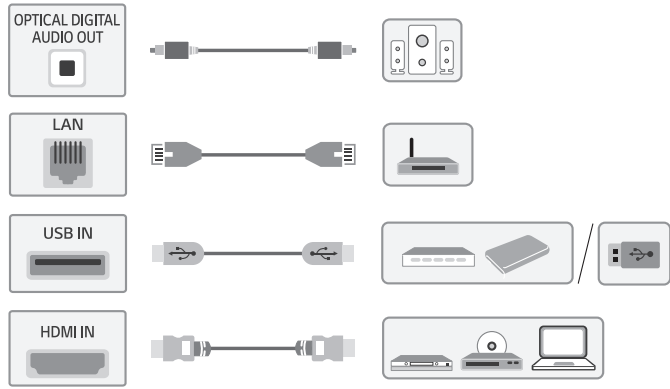

	A	B	C	D	E	F	F-G
	(mm)					(kg)	
75UP81003LA 75UP81006LA 75UP81009LA	1678	1045	378	964	59.9	34.6	31.4
Power requirement				AC 100-240 V - 50 / 60 Hz			



- English · Read **Safety and Regulatory**.
- Deutsch · Lesen Sie die **Sicherheitsanweisungen und Richtlinien**.
- Français · Lire le document **Sécurité et mesures réglementaires**.
- Italiano · Leggere il manuale **Sicurezza e normative**.
- Español · Leer **Seguridad y normativa**.
- Português · Ler informações sobre a **Segurança e Regulamentos**.
- Nederlands · **Veiligheidsinformatie en regelgeving** lezen.
- Ελληνικά · Διαβάστε τις **οδηγίες για την ασφάλεια και τους κανονισμούς**.
- Slovenščina · Preberite **varnostne in regulativne vidike**.

- Hrvatski · Pročitajte **Sigurnost i uskladenost s propisima**.
- Shqip · Lexoni paragrafin **"Siguria dhe rregullimi"**.
- Bosanski · Pročitajte dio **Sigurnost i propisi**.
- Македонски · Прочитajte за **безбедноста и регулативата**.
- Svenska · Läs **Säkerhet och föreskrifter**.
- Magyar · Biztonsági szabályzat megtekintése.
- Polski · Prosimy o przeczytanie **Zasad bezpieczeństwa i uwag dotyczących przepisów**.
- Česky · Přečtěte si část **Bezpečnost a zákonné předpisy**.
- Slovenčina · Prečítajte si **bezpečnostné a regulačné informácie**.

- Română · Consultați manualul referitor la **siguranță și reglementare**.
- Български · Прочетете **Безопасност и регулаторни стандарти**.
- Eesti · Lugege **ohutus- ja normatiivteavet**.
- Lietuvių k. · Perskaitykite **Saugos ir norminius reikalavimus**.
- Latviešu · Izlasiet sadaļu **Drošība un normatīvi**.
- Srpski · Pročitajte odeljak **Bezbednost i regulatorna pitanja**.
- Norsk · Les **sikkerhet og forskrifter**.
- Dansk · Læs **sikkerhed og lovmæssige bestemmelser**.
- Suomi · Lue **Turvallisuus ja säännökset** -osio.

⊕ : Depending on model / Abhängig vom Modell / Selon le modèle / In base al modello / En función del modelo / Dependendo do modelo / Afhankelijk van het model / Αν λογα με το μοντ λο / Odvisno od modela / Tipusfüggő / Zależnie od modelu / Závvislosti od modelu / In functie de model / в зависимости от модели / Sõltub mudelist / Priklauso nuo modelio / Atkarībā no modeļa / U zavisnosti od modela / Ovisno o modelu / Në varësi të modelit / Ovisno o modelu / во зависност од моделот / Beroende på modell / Afhängigt av modellen / Mallin mukaan