

Additional Information

Specifications

Power Requirements	Refer to the main label on the unit.
Power Consumption	Refer to the main label on the unit.
Dimensions (W x H x D)	Approx. 450.0 mm x 167.0 mm x 332.0 mm
Bus Power Supply (USB)	5 V  500 mA
Amplifier (Total RMS output power)	2,350 W RMS

Design and specifications are subject to change without notice.

Replacement of battery

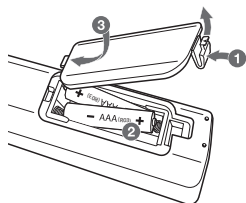

About Ferrite Core (Optional)

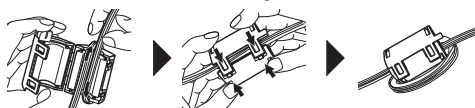

Wind power cord cable around the ferrite core twice.

Caution

- When you use the multiple socket, it is advisable to use 15 A socket. 10 A socket may cause power off due to lack of power supply.
- Do not place objects on the speakers. It may cause the objects to fall and make property damage.
- Install the speakers on a firm surface not to slide. The vibration caused by the strong output can shake and move the speakers.
- Avoid turning up max volume in a small enclosed space. The powerful and intense output of the speakers can shake the ceiling and get the objects in the room falling.

- To protect from hearing damage, keep the sufficient distance from the speaker. The overwhelming sound from the speaker may cause a person's hearing damage.
- Connect the power cord to wall outlet directly if possible. Or when you use an extension cable, it is highly recommended to use an extension cable of 110 V / 15 A or 230 V / 15 A, otherwise the unit may not operate properly because of the lack of power supply.
- Do not overload the extension cord with excessive electrical load.

Note

- Do not look directly at the light emitting part when the LIGHTING is turned on.
- If the illumination brightness is glaring, switch on the room lights or turn off the LIGHTING of the unit.

POWER: This unit operates on a mains supply of 200 - 240 V ~ 50 / 60 Hz.

Wiring: This unit is supplied with a BS 1363 approved main plug. When replacing the fuse, always use a fuse of the same rating and approved to BS 1362. Never use this plug with the fuse cover omitted. To obtain a replacement fuse cover contact your dealer. If the type of plug supplied is not suitable for the mains sockets in your home, then the plug should be removed and a suitable type fitted. Please refer to the wiring instructions below:

Warning: A mains plug removed from the mains lead of this unit must be destroyed. A mains plug with bared wires is hazardous if inserted in a mains socket. Do not connect either wire to the earth pin, marked with the letter E or with the earth symbol  or coloured green or green and yellow. If any other plug is fitted, use same rating of fuse in the plug.

Important: The wires in this mains lead are coloured in accordance with the following codes:

- **BLUE: NEUTRAL, BROWN: LIVE** - As the colours of the wires in the mains lead of this unit may not correspond with the coloured marking identifying the terminals in your plug, proceed as follows: The wire which is coloured blue must be connected to the terminal which is marked with the letter N or coloured black. The wire which is coloured brown must be connected to the terminal which is marked with the letter L or coloured red.



SIMPLE MANUAL

Mini Hi-Fi System

Please read this manual carefully before operating your set and retain it for future reference.

To view the instructions of advanced features, visit <http://www.lg.com> and then download Owner's Manual.

Some of the content in this manual may differ from your unit.

MODEL

CL87



This product has no disc drive.



MFL72147602
2407_Rev01

www.lg.com

Copyright © 2025 LG Electronics Inc. All Rights Reserved.

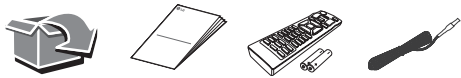

Front Panel

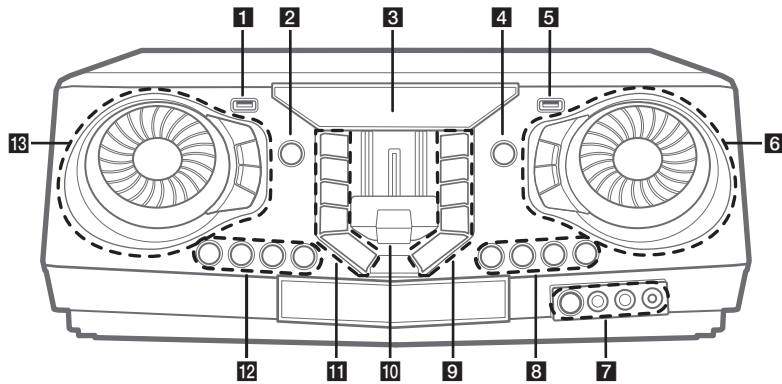

1 USB 1 Port

You can play sound files by connecting the USB device.

2 ⏻ (Standby)

Turns the power on or off.

3 Display window

4 F (Function)

Selects the function and input source.

5 USB 2 Port

You can play sound files by connecting the USB device.

6 MASTER VOLUME

- Adjusts speaker volume.
- Selects the lighting effects.
- Selects vocal effects.

LIGHTING

Selects the lighting mode.

MIC VOL (Microphone volume) -/+

Adjusts microphone volume.

MIC (Microphone) ECHO

Selects ECHO mode.

7 R (Remote sensor)

MIC (Microphone) 1/2 jack

AUX IN 1 jack

8 KEY CHANGER (#/b)

Changes the key to suit your vocal range.

VOICE CANCELLER

You can reduce the vocal tones during music playback from various input sources.

VOCAL EFFECTS

Selects various vocal effects mode.

9 TWIN

Connects two speakers for TWIN mode in WIRELESS PARTY LINK.

DJ LOOP

Selects DJ LOOP mode.
(DJ LOOP mode can use during USB playback.)

⏮ (Play/Pause)

- Starts or pauses playback.
- Selects stereo/mono.

⏭ (Skip/Search)

- Skips forward.
- Searches for a section within a file.
- Selects the radio stations.

PARTY ACCELERATOR MODE

Selects PARTY ACCELERATOR MODE.

10 PARTY ACCELERATOR lever

Slide the lever to create a party atmosphere.

11 USB REC / DEMO

- Records to USB.
- Stops Recording.
- In power off status, if you press **USB REC / DEMO**, show DEMO mode.

SPECIAL EQ / BASS BLAST (or BASS BLAST+)

- Chooses special equalizer.
- Press and hold to select BASS (or BASS+) effect directly.

□ (Stop)

Stops playback or cancels DELETE function.

⏮ (Skip/Search)

- Skips backward.
- Searches for a section within a file.
- Selects the radio stations.

i (Information)

- Sees information about your music. An MP3 file often come with ID3 tag. The tag gives the Title, Artist, Album or Time information.
- Sees **Bluetooth** device name of the unit in BT READY.
- Sees the name of connected all **Bluetooth** device in **Bluetooth** mode.
- When these units are successfully connected each other in WIRELESS PARTY LINK mode, each of connected device names appears in the each unit.

12 CLUB, DRUM, USER (DJ PAD)

Selects CLUB, DRUM or USER sound effect to mix. (If you want to use USER, you have to register a source with "LG XBOOM" app.)

1, 2, 3, 4 (DJ PAD)

Press a desired sound pad.

13 DJ SCRATCHER / LEVEL CONTROL & SEARCH

- Turns clockwise or counterclockwise to make scratch sound.
- Turns clockwise or counterclockwise to control the USER EQ level.
- Searches a folder or a file.
- Adjust DJ EFFECT level.

DJ EFFECT

Selects a desired DJ EFFECT.

SEARCH

Moves to folder or file in selection mode.

OK

Selects a folder when searching a file.

USER EQ

Selects the equalizer created by your own

Rear Panel

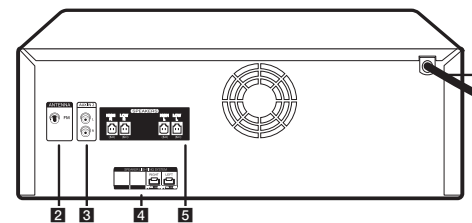

1 Power cord

2 ANTENNA (FM)

3 AUX IN 2 (L/R)

4 SPEAKER LIGHTING SYSTEM

Connect the speaker lighting cables.

5 SPEAKERS connector

Controller App



Download the **LG XBOOM** App to your device. (Android only)

Speaker Connection

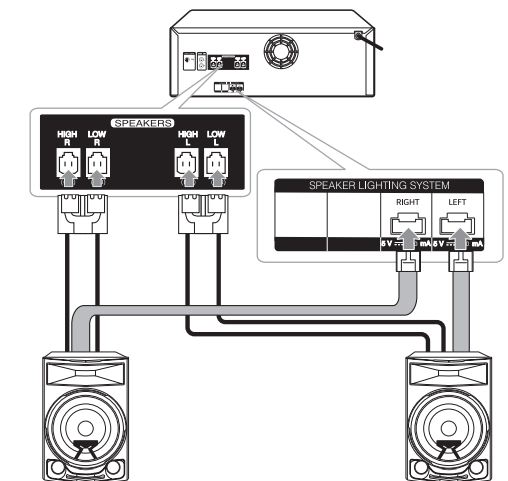

LG Sound Sync (Wireless)



For more information, download the online owner's manual. <http://www.lg.com>