

+ : Depending on model / Tergantung pada modelnya / حسب الطراز



English

Bahasa
Indonesia

- Read **Safety and Reference**.
- For the power supply and power consumption, refer to the label attached to the product.
- Baca **Keselamatan dan Referensi**.
- Untuk informasi catu daya dan konsumsi daya, baca label yang disertakan pada produk.

• قراءة الأمان والمرجع .

• لمعرفة المزيد حول مصدر الإمداد بالطاقة المطلوب ومعايير استهلاك الطاقة، راجع الملصق الموجود على المنتج .

العربية

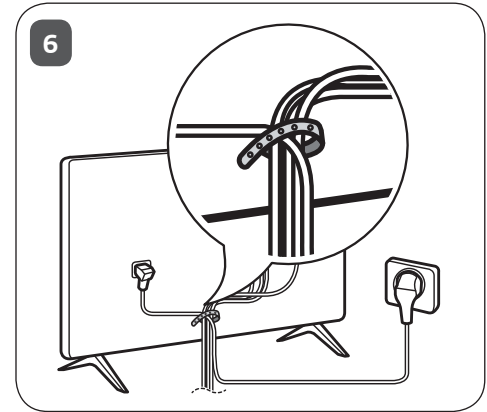
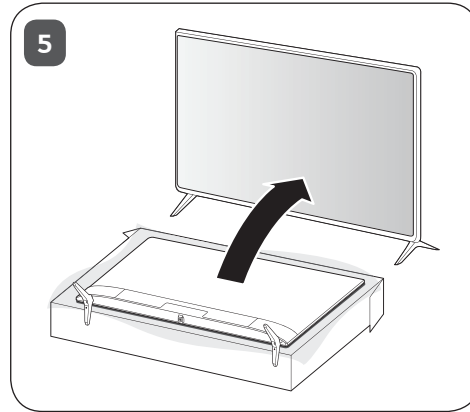
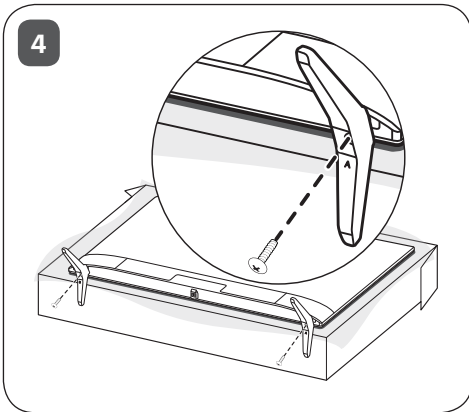
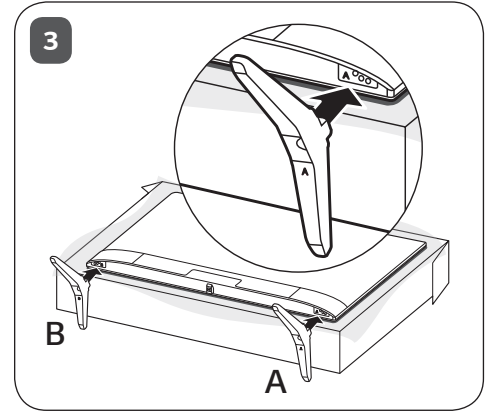
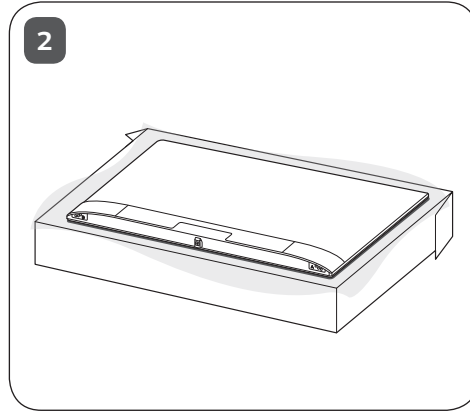
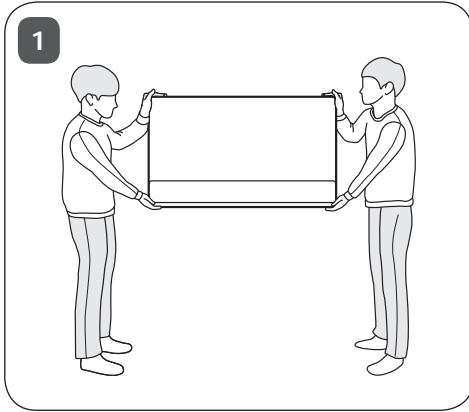

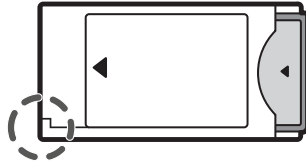
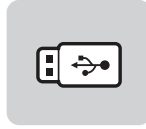
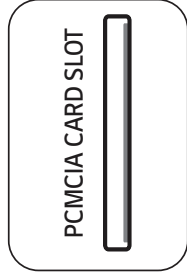
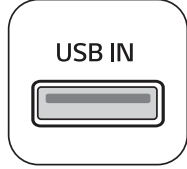
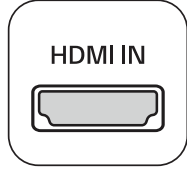
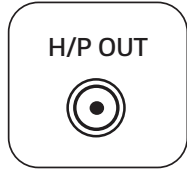
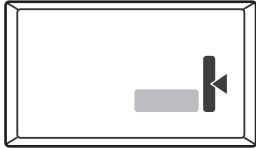

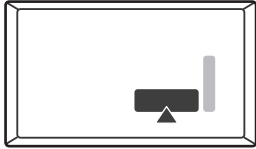

ANTENNA/
CABLE IN

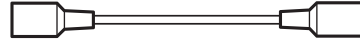
A circular port with a central hole, used for antenna or cable connections.

+

Satellite IN

A circular port with a central hole, used for satellite dish connections.

HDMI IN

A rectangular port with a notch, used for HDMI connections.

OPTICAL
DIGITAL
AUDIO OUT

A square port with a small square opening, used for optical digital audio connections.

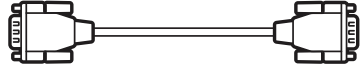
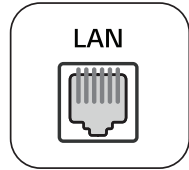
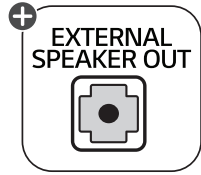
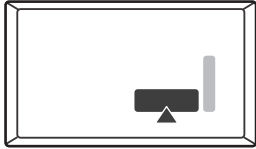



COMPONENT IN

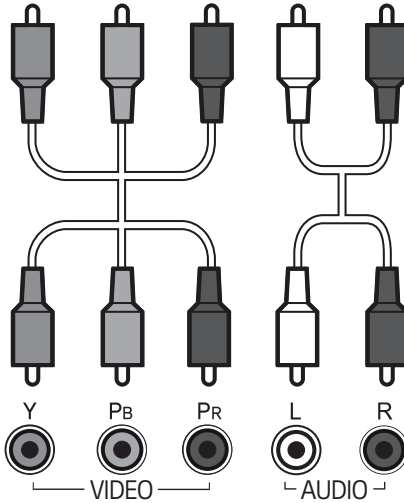
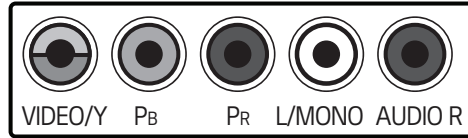

AV IN

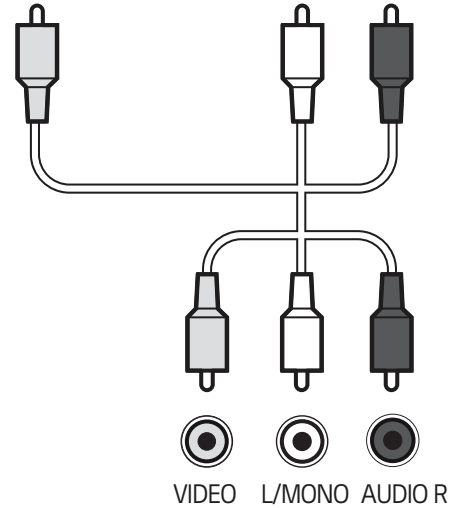
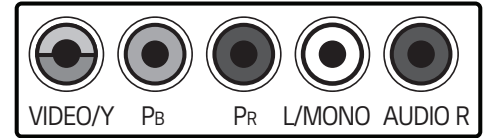

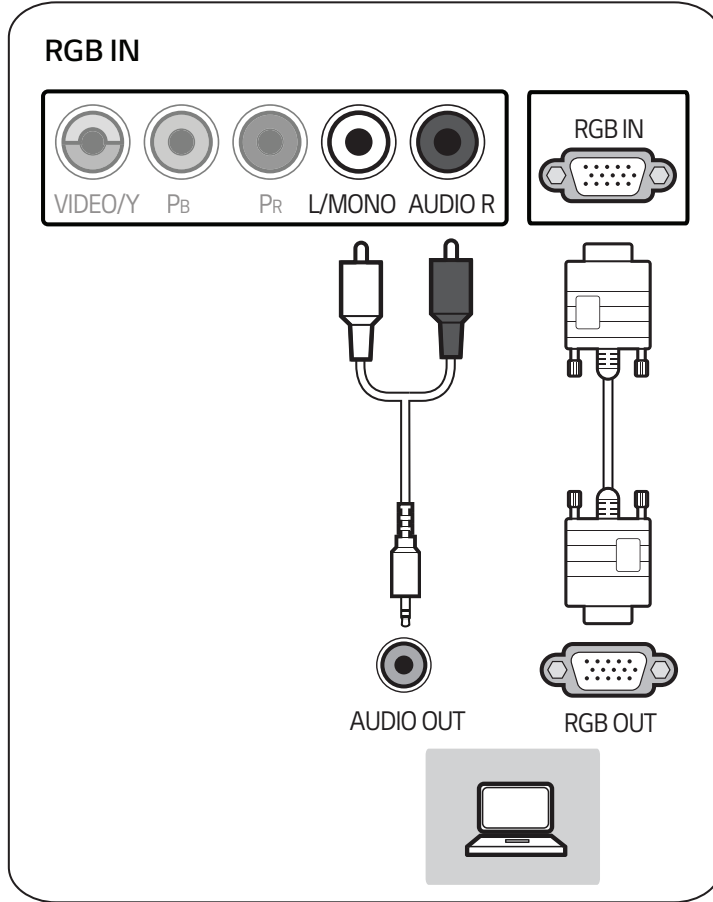
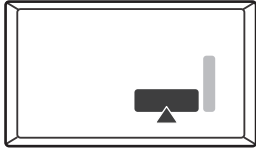



+

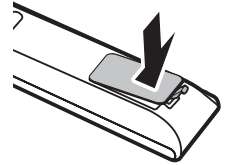
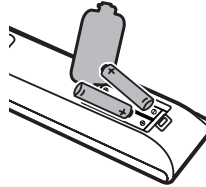
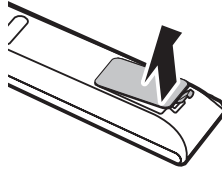
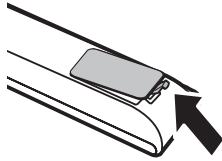
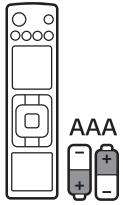
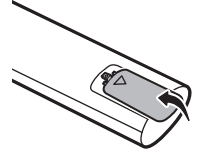
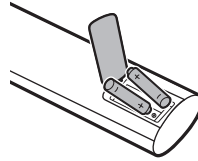
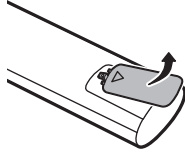
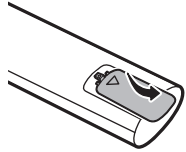
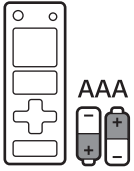



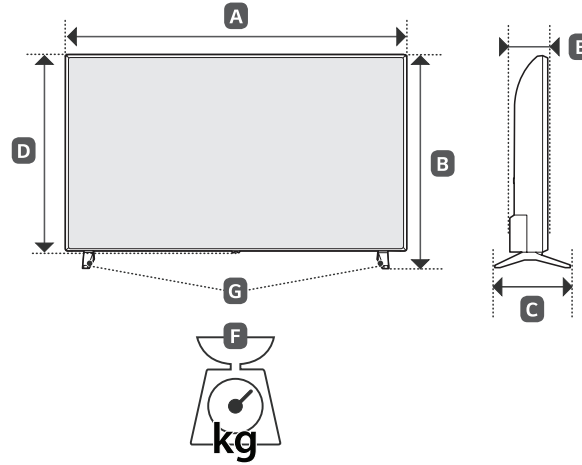

	A		B		C		D		E		F		F - G				
	(mm)														(kg)		
32LT340CBTB 32LT340CBGB 32LT340HBGB 32LT340H9GB 32LT340C9TB	739	739	472	472	168	168	441	441	84	84	4.90	4.90	4.85	4.85			
43LT340C0TB 43LT340C0GB 43LT340H0GB 43LT340C9TB	977	977	615	615	187	187	575	575	80.8	80,8	8.1	8,1	8.0	8,0			
Power requirement / Persyaratan daya / متطلبات الطاقة									AC 100-240 V ~ 50 / 60 Hz تيار متردد 100 - 240 فولت ~ 50 / 60 هرتز								



* M F L 7 1 4 4 7 4 0 1 *
(2107-REV01)