



Scan to see the online manual.



# OWNER'S MANUAL

# COMBINATION

# WALL OVEN

---

Read this owner's manual thoroughly before operating the appliance and keep it handy for reference at all times.

**ENGLISH**

WCEP6423\*



MFL70581909  
Rev.06\_013026

[www.lg.com](http://www.lg.com)

Copyright © 2023-2026 LG Electronics. All Rights Reserved

# TABLE OF CONTENTS

## 4 IMPORTANT SAFETY INSTRUCTIONS

---

### 4 READ ALL INSTRUCTIONS BEFORE USE

- 4 Precautions to Avoid Possible Exposure to Excessive Microwave Energy
- 4 Safety Messages

### 4 WARNING

- 4 Technical Safety
- 6 Installation
- 6 Operation
- 7 Maintenance
- 7 Risk of Fire and Flammable Materials
- 8 Microwave Oven
- 8 Radio/TV/Wireless Equipment Interference
- 8 Federal Communications Commission Radio Frequency Interference Statement (U.S.A. Only)

### 9 CAUTION

- 9 Operation
- 9 Maintenance

## 11 PRODUCT OVERVIEW

---

### 11 Product Features

- 11 Exterior / Interior
- 11 Accessories

## 14 OPERATION

---

### 14 Operating Control Panel

- 14 Control Panel Features
- 14 Energy Saving Tips

### 16 Changing Settings

- 16 Clock
- 16 Oven Light
- 16 Timer On/Off
- 17 Settings (Hour Mode, Convection Auto Conversion, Oven Temperature, Display Language, Preheat Alarm Light, Beeper Volume, Fahrenheit or Celsius)
- 18 Control Lock
- 18 Start Time (Delayed Timed Cook) (Lower Oven Only)
- 19 Cook Time (Timed Cook)
- 19 Wi-Fi

- 19 Remote Start

### 21 Operating the Upper Microwave Oven

- 21 Before Using
- 21 Microwave Cookware Guide
- 22 Cooking Tips
- 23 Microwave Power Levels
- 24 Microwave Mode
- 24 +30 Seconds Mode
- 24 Defrost Mode
- 25 Sensor Cook Mode
- 27 Convection Bake Mode
- 27 Broil Mode
- 28 Popcorn Mode
- 28 Warm Mode
- 29 Proof Mode
- 29 Auto Cook Mode
- 31 More Modes (Soften, Melt, Air Fry, Dehydrate)

### 35 Operating the Lower Oven

- 35 Before Using the Oven
- 35 Using Heavy Duty Oven Racks
- 35 Using Gliding Oven Racks
- 36 Convection Bake and Roast Mode
- 37 Bake Mode
- 38 Recommended Baking Guide
- 39 Broil Mode
- 40 Recommended Broiling Guide
- 42 More Modes (Frozen Meal)
- 43 More Modes (Warm)
- 43 More Modes (Proof)
- 43 More Modes (Favorite)
- 44 Air Fry
- 45 Recommended Air Frying Guide
- 47 Remote Start Mode
- 47 Sabbath Mode

## 49 SMART FUNCTIONS

---

### 49 LG ThinQ Application

- 49 LG ThinQ Application Features
- 49 Installing LG ThinQ Application and Connecting an LG Appliance
- 50 Radio Equipment Specifications
- 50 Industry Canada Statement
- 50 Open Source Software Notice

---

Information

**50 Smart Diagnosis™ Feature**

- 50 Using LG ThinQ to Diagnose Issues
- 51 Using Audible Diagnosis to Diagnose Issues

**52 MAINTENANCE**

---

**52 Cleaning**

- 52 General Cleaning Tips
- 52 Exterior
- 53 EasyClean (Lower Oven)
- 55 Self Clean (Lower Oven)

**58 Periodic Maintenance**

- 58 Changing the Oven Light

**59 TROUBLESHOOTING**

---

**59 FAQs**

- 59 Frequently Asked Questions

**63 Before Calling for Service**

- 63 Cooking
- 65 Parts & Features
- 66 Noises
- 66 Wi-Fi

**68 LIMITED WARRANTY**

---

**68 CANADA**

- 68 TERMS AND CONDITIONS
- 69 THIS LIMITED WARRANTY DOES NOT COVER
- 71 PROCEDURE FOR RESOLVING DISPUTES

# IMPORTANT SAFETY INSTRUCTIONS

## READ ALL INSTRUCTIONS BEFORE USE

### Precautions to Avoid Possible Exposure to Excessive Microwave Energy

- (a) Do not attempt to operate this oven with the door open since open-door operation can result in harmful exposure to microwave energy. It is important not to defeat or tamper with the safety interlocks.
- (b) Do not place any object between the oven front face and the door or allow soil or cleaner residue to accumulate on sealing surfaces.
- (c) Do not operate the oven if it is damaged. It is particularly important that the oven door close properly and that there is no damage to the: (1) door (bent), (2) hinges and latches (broken or loosened), (3) door seals and sealing surfaces.
- (d) The oven should not be adjusted or repaired by anyone except properly qualified service personnel.

### Safety Messages

**Your safety and the safety of others are very important.**

We have provided many important safety messages in this manual and on your appliance. Always read and follow all safety messages.



This is the safety alert symbol.

This symbol alerts you to potential hazards that can kill or injure you and others. All safety messages will follow the safety alert symbol and either the word **WARNING** or **CAUTION**.

These words mean:



#### **WARNING**

You may be killed or seriously injured if you do not follow instructions.



#### **CAUTION**

You may be injured or cause damage to the product if you do not follow instructions.

All safety messages will tell you what the potential hazard is, tell you how to reduce the chance of injury, and tell you what may happen if the instructions are not followed.

## WARNING

---

### **WARNING**

- To reduce the risk of explosion, fire, death, electric shock, injury or scalding to persons when using this product, follow basic precautions, including the following:
- 

### Technical Safety

- To reduce the risk of burns, electric shock, fire, injury to persons or exposure to excessive microwave energy when using the microwave oven, read all instructions before using the appliance.
- This appliance is not intended for use by persons (including children) with reduced physical, sensory or mental capabilities, or lack of experience and knowledge, unless they have been given supervision or instruction concerning use of the appliance by a person responsible for their safety. Children should be supervised to ensure that they do not play with the appliance.

- Children must not be allowed to play with accessories or hang down from the door or any part of the oven. Doing so can cause serious injury and damage. As with any appliance, close supervision is necessary when used by children.
- Read and follow the **Precautions to Avoid Possible Exposure to Excessive Microwave Energy**.
- This appliance must be grounded. Connect only to a properly grounded outlet. See the **Electrical Requirements** section.
- Install or locate this appliance only in accordance with the provided installation instructions.
- Some products such as whole eggs and sealed containers – for example, closed glass jars – can explode and should not be heated in this oven.
- Use this appliance only for its intended use as described in the manual. Do not use corrosive chemicals or vapors, such as sulfide and chloride, in this appliance. This type of oven is specifically designed to heat, cook, or dry food. It is not designed for industrial or laboratory use.
- This appliance should be serviced only by qualified service personnel. Contact the nearest authorized service facility for examination, repair, or adjustment.
- Do not cover or block any openings on the appliance.
- Do not store this appliance outdoors. Do not use this product near water - for example, near a kitchen sink, in a wet basement, near a swimming pool, or similar location.
- To avoid electric shock:
  - Do not operate this appliance if it has a damaged cord or plug, if it is not working properly or if it has been damaged or dropped.
  - Do not immerse the electrical cord or plug in water. Keep cord away from heated surfaces.
  - Do not let cord hang over edge of table or counter.
- When cleaning surfaces of door and oven that come together on closing the door, use only mild, nonabrasive soaps or detergents applied with a sponge or soft cloth.
- **DO NOT TOUCH HEATING ELEMENTS OR INTERIOR SURFACES OF MICROWAVE OVEN.** During and after use or cleaning the Interior, do not touch other flammable materials contact heating elements or interior surfaces of microwave oven until they have had sufficient time to cool. Other surfaces, such as windows of microwave oven door, oven lamp, also get hot and may cause burns if not allowed to cool.
- To reduce the risk of fire in the oven cavity:
  - Do not overcook food. Carefully attend to the microwave oven when paper, plastic or other combustible materials are placed inside the oven to facilitate cooking.
  - Do not use the cavity for storage purposes. Do not leave paper products, cooking utensils or food in the cavity when not in use.
  - Remove wire twist-ties from paper or plastic bags before placing bags in oven.
- If materials inside the oven ignite:
  - Keep oven door closed and turn the oven off.
  - Disconnect the power cord or shut off power at the fuse or circuit breaker panel.
- Liquids, such as water, coffee, or tea can be overheated beyond the boiling point without appearing to be boiling due to surface tension of the liquid. Visible bubbling or boiling when the container is removed from the microwave oven is not always present.
- **THIS COULD RESULT IN VERY HOT LIQUIDS SUDDENLY BOILING OVER WHEN THE CONTAINER IS DISTURBED OR A SPOON OR OTHER UTENSIL IS INSERTED INTO THE LIQUID.**  
To reduce the risk of injury to persons:
  - Do not overheat the liquid. Stir the liquid both before and halfway through heating it.
  - Do not use straight-sided containers with narrow necks. Use extreme care when inserting a spoon or other utensil into the container.
  - After heating, allow the container to stand in the microwave oven for a short time before removing the container.
- Do not mount unit over or near any portion of a heating or cooking appliance.

## 6 IMPORTANT SAFETY INSTRUCTIONS

---

- Do not mount over a sink.
- Do not store anything directly on top of the appliance surface when the appliance is in operation.

### Installation

- Never allow anyone to climb, sit, stand or hang on the oven door. Injury might result from contact with hot food or the oven itself.
- Do not line the oven walls, racks, bottom, or any other part of the oven with aluminum foil or any other material. Doing so will disrupt heat distribution, produce poor baking results and cause permanent damage to the oven interior. (Aluminum foil will melt on the interior surface of the oven.)
- Do not use aluminum foil or any other material to line the oven bottom. Improper installation of oven liners may result in a risk of electric shock or fire.
- Make sure your appliance is properly installed and grounded by a qualified installer, according to the installation instructions. Any adjustment and service should be performed only by qualified installers or service technicians.
- Be certain that all packing materials are removed from the appliance before operating. Keep plastic, clothes, paper, and other flammable materials away from parts of the appliance that may become hot.
- The electrical power must be shut off while the electrical connections are being made.
- Improper connection of aluminum house wiring to copper leads can result in an electrical hazard or fire. Use only connectors designed for joining copper to aluminum and follow the manufacturer's recommended procedure closely.
- Important – Save for the local electrical inspector's use

### Operation

- DO NOT TOUCH HEATING ELEMENTS OR INTERIOR SURFACES OF OVEN. Heating elements may be hot even though they are dark in color. Interior surfaces of an oven become hot enough to cause burns. During and after use, do not touch or let clothing or other flammable materials contact heating elements or interior surfaces of oven until they have had sufficient time to cool. Other surfaces, such as oven vent openings and surfaces near these openings, oven doors, and windows of oven doors, also get hot and may cause burns if not allowed to cool.
- Use care when opening door. The hot air and steam that escape can cause burns to hands, face and eyes. Let hot air or steam escape from the oven before removing or replacing food in the oven.
- Do not use plastic to cover food. Use foil or oven-safe lids only.
- Never attempt to dry a pet in the oven.
- Never use your appliance for warming or heating the room.
- Always use pot holders or oven mitts when removing food from an oven or cooktop. Cookware will be hot. Use only dry pot holders. Moist or damp pot holders on hot surfaces may result in burns from steam. Do not let the pot holder touch hot heating elements. Do not use a towel or other bulky cloth to remove food.
- Do not heat unopened food containers. Pressure in the containers may cause them to burst which may result in injury.
- Do not allow aluminum foil or the temperature probe to contact heating elements.
- Do not touch the oven racks while they are hot.
- Only arrange oven racks when the oven is cool. If a rack must be moved while the oven is hot, do not let the pot holder contact the hot heating element in the oven.
- Pull the oven rack to the stop-lock position when loading and unloading food from the oven. This helps prevent burns caused by touching hot surfaces of the door and oven walls.
- Do not use the oven if a heating element develops a glowing spot during use or shows other signs of damage. A glowing spot indicates the heating element may fail and present a potential burn, fire, or

shock hazard. Turn the oven off immediately and have the heating element replaced by a qualified service technician.

- Do not leave children alone or unsupervised near the appliance when it is in use or is still hot. Children should never be allowed to sit or stand on any part of the appliance as they could be injured or burned.
- DO NOT block the oven vent during operation. This can damage the electric parts of the oven. Air must be able to move freely. The bottom vent trim should be properly assembled on the front bottom of oven before installing the oven door.
- Do not put large, heavy items such as whole turkeys on the open oven door.
- Take care when the door is open to avoid injury.
- If the door or door seals are damaged, the oven must not be operated until it has been repaired by a competent person.
- Do not allow children to crawl into the oven.
- Do not put your hand under the controller or between the door and bottom vent trim during operation. The outside of the oven can become very hot to the touch.

## Maintenance

- Let hot cookware and utensils cool in a safe place, out of reach of small children.
- If the door glass, surface, or oven heating unit of the appliance are damaged, discontinue use of the appliance and call for service.
- Always disconnect power from the appliance before servicing.
- Before replacing the oven light, switch off the electrical power to the oven at the main fuse or circuit breaker panel.
- Never pour cold water over a hot oven for cleaning purposes.
- Oversized food or oversized metal cookware should not be inserted in a microwave/toaster oven as they may create a fire or risk of electric shock.
- Do not clean with metal scouring pads. Pieces can burn off the pad and touch electrical parts causing a risk of electric shock.
- Do not store any materials, other than manufacturer's recommended accessories, in this oven when not in use.
- Do not cover racks or any other part of the oven with metal foil. This will cause overheating of the oven.
- If the self-cleaning mode malfunction light goes on, or if the audible signal sounds, turn off or disconnect the appliance from the power supply and have it serviced by a qualified technician.
- If the oven is heavily soiled with oil, self-clean the oven before using the oven again. The oil could cause a fire.
- If there is a fire in the oven during self-clean, turn the oven off and wait for the fire to go out. Do not force the door open. Introduction of fresh air at self-clean temperatures may lead to a burst of flame from the oven. Failure to follow this instruction may result in severe burns.
- If your oven is dropped or damaged, have it thoroughly checked by a qualified service technician before using it.

## Risk of Fire and Flammable Materials

- Do not store or use flammable material in or near the oven. Flammable materials include paper, plastic, pot holders, linens, wall coverings, curtains, and gasoline or other flammable vapors and liquids such as grease or cooking oil. These materials can be ignited when the oven is in use.
- Use extreme caution when moving or disposing of hot grease.
- Wear proper apparel. Do not wear loose-fitting or hanging garments, which may ignite if they contact hot surfaces, and cause severe burns.
- Do not use the oven for drying clothes. Only use the oven for its intended purpose.

## 8 IMPORTANT SAFETY INSTRUCTIONS

---

- If cabinet storage is provided directly above the oven, use it to store items that are not frequently used and can be safely stored in an area subjected to heat. Temperatures may be unsafe for volatile items such as flammable liquids, cleaners or aerosol sprays.
- Do not use water on grease fires. Should an oven fire occur, leave the oven door closed and turn the oven off. If the fire continues, throw baking soda on the fire or use a fire extinguisher. Do not put water or flour on the fire. Flour may be explosive and water can spread a grease fire and cause personal injury.

### **Microwave Oven**

- The oven must be installed following the provided installation instructions.
- Secure the cord in the cabinet above the oven.
- Preserve the oven floor:
  - Do not heat the oven floor excessively.
  - Do not cook anything directly on the oven floor or turntable. Use a microwavable dish.
- Do not heat any type of baby bottle or baby food. Uneven heating may occur and possibly cause personal injury.
- Do not deep-fat fry in the oven.
- Do not attempt home canning in the microwave oven.
- Do not use cylindrical-shaped containers.
- In all containers, for best results, stir the liquid several times before heating. Always stir liquid several times between reheatings.
- Place food directly on the trays when cooking unless prompted by the oven to do otherwise.

### **Radio/TV/Wireless Equipment Interference**

- Operating the microwave oven near equipment-such as a radio, TV, wireless LAN, Bluetooth devices, medical equipment, or wireless equipment which uses the same frequency, may cause interference. This interference is not an indication of a defect in the product or its operation. The product is safe to use.
- Do not use medical equipment near the microwave oven, as the interference could affect the medical equipment's operation.
- When there is interference, it may be reduced or eliminated by taking the following measures:
  - Clean the door and the sealing surfaces of the oven.
  - Reorient the receiving antenna of the radio, TV, Bluetooth, or other equipment.
  - Relocate the microwave oven in relation to the radio, TV, Bluetooth, or other equipment.
  - Move the microwave oven away from the receiver.
  - Plug the microwave oven into a different outlet so that the microwave oven and receiver are on different branch circuits.

### **Federal Communications Commission Radio Frequency Interference Statement (U.S.A. Only)**

- This equipment generates and uses ISM frequency energy and if not installed and used properly, that is in strict accordance with the manufacturer's instructions, may cause interference to radio and television reception. It has been type tested and found to comply with limits for ISM Equipment pursuant to part 18 of FCC Rules, which are designed to provide reasonable protection against such interference in a residential installation. However, there is no guarantee that interference will not occur in a particular installation. If this equipment does cause interference to radio or television reception, which can be determined by turning the equipment off and on, the user is encouraged to try to correct the interference by one or more of the following:
  - Reorient the receiving antenna of the radio or television.

- Relocate the microwave oven with respect to the receiver.
- Move the microwave oven away from the receiver.
- Plug the microwave oven into a different outlet so that the microwave oven and the receiver are on different branch circuits.
- The manufacturer is not responsible for any radio or TV interference caused by unauthorized modification to this microwave oven. It is the responsibility of the user to correct such interference.

## CAUTION

### CAUTION

- To reduce the risk of minor injury to persons, malfunction, or damage to the product or property when using this product, follow basic precautions, including the following:

## Operation

- Always heat fat slowly, and watch as it heats.
- If frying combinations of oils and fats, stir them together before heating.
- Use a deep fat thermometer, if possible, to prevent overheating fat beyond the smoking point.
- Use the least possible amount of fat for effective shallow or deep-fat frying. Filling the pan with too much fat can cause spillovers when food is added.
- Accessible parts may become hot when the grill is in use.
- Do not place food or cookware on the bottom of the oven cavity. Doing so will cause permanent damage to the oven bottom finish.
- When using cooking or roasting bags in the oven, follow the manufacturer's directions.
- To protect against food-borne illnesses, cook meat and poultry thoroughly. The USDA has indicated the following as safe minimum internal temperatures for consumption:
  - Ground beef: 160 °F (71 °C)
  - Poultry: 165 °F (74 °C)
  - Beef, veal, pork, or lamb: 145 °F (63 °C)
  - Fish/seafood: 145 °F (63 °C)
- Do not use this oven for commercial purposes. It is made for household use only.
- The door or the outer surface may get hot when the appliance is operating.
- Do not use this oven for purposes other than cooking.
- Use caution if opening the door when the oven is operating. Hot surfaces can cause serious burns.

## Maintenance

- Do not repair or replace any part of the appliance unless specifically recommended in the manual. All other servicing should be performed by a qualified technician.
- Do not use harsh, etching, abrasive cleaners or sharp metal scrapers to clean the oven door glass since they can scratch the surface. Scratches may cause the glass to shatter.
- Make sure oven lights are cool before cleaning.
- Do not clean the door gasket. The door gasket is essential for a good seal. Care should be taken not to rub, damage, or move the gasket.
- Never keep pet birds in the kitchen. The health of birds is extremely sensitive to the fumes released during an oven self-clean cycle. Fumes may be harmful or fatal to birds. Move birds to a well-ventilated room.

## 10 IMPORTANT SAFETY INSTRUCTIONS

---

- Do not rinse trays and racks by placing them in water just after cooking. This may cause breakage or damage.
- The oven should be cleaned regularly and any food deposits should be removed. Failure to maintain the oven in a clean condition could lead to deterioration of the surface that could shorten the life of the appliance and possibly result in a hazardous situation.
- Clean in the self-clean cycle only parts listed in this manual. Before self-cleaning the oven, remove the broiler pan, all oven racks and any utensils or food from the oven.
- Do not store items of interest to children on the back guard or in cabinets above a cooking appliance. Children climbing on the oven to reach items could be seriously injured.

**SAVE THESE INSTRUCTIONS**

# PRODUCT OVERVIEW

## Product Features

The appearance and specifications listed in this manual may vary due to constant product improvements.

### Exterior / Interior

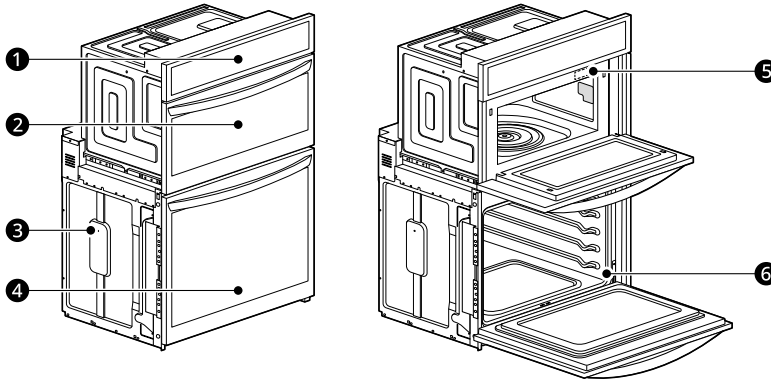

1	Oven Controller	4	Lower Oven Door
2	Upper Oven Door	5	Rating Label, Model and Serial Number Plate
3	Spacer	6	Gasket

## Accessories

### Accessories for Upper Oven

The turntable rotates in both directions to help food cook more evenly. Do not operate the microwave oven without the glass tray in place.

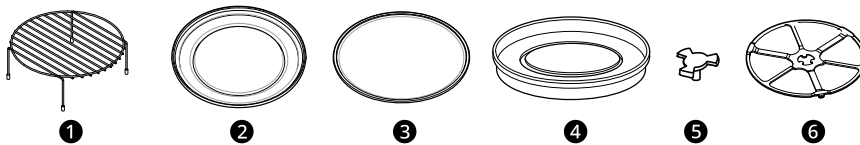

- 1 Rack (For the Convection Bake and Broil functions) (1 ea)
- 2 Metal Tray (For the Convection Bake and Broil functions) (1 ea)
- 3 Glass Tray (For the Microwave and Defrost functions) (1 ea)
- 4 Air Fry Pan (For the Air Fry function) (1 ea)
- 5 Shaft (1 ea)
- 6 Rotating Ring (1 ea)

## Accessories for Lower Oven

### Accessories for Cooking

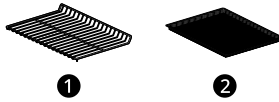

- ❶ Heavy Duty Rack (2 ea)
- ❷ Air Fry Tray (1 ea)

### Accessories for Installation

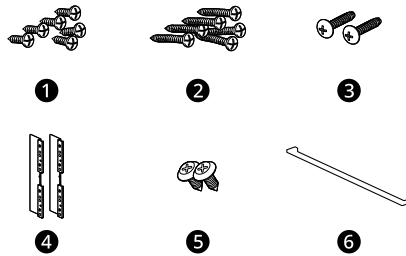

- ❶ 4x14 Wood Screws for Mounting (6 ea) (4 needed for installation and 2 extras)
- ❷ 3x27 Wood Screws for Mounting for Flush Installation (6 ea)
- ❸ 4x22 Self-Tapping Screws for Cover Bracket (2 ea)
- ❹ Cover Brackets for Flush Installation (2 ea)
- ❺ 4x10 Screws for Bottom Decorative Trim (2 ea)
- ❻ Bottom Decorative Trim (1 ea)

### Manuals

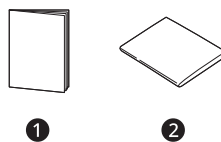

- ❶ Owner's Manual (1 ea)
- ❷ Installation Manual (1 ea)



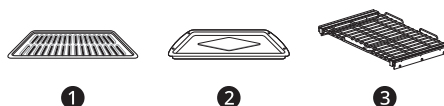

### Optional Accessories (sold separately)



- ❶ Grid
- ❷ Broiler Pan

3 Gliding Rack

**How to Use Accessories**

				
<b>Microwave</b> Sensor Cook, Popcorn, Defrost, Soften, Melt	○	△	-	-
<b>Conv. Bake</b> Dehydrate, Warm, Proof	-	○	△	-
<b>Broil</b>	-	△	○	-
<b>Air Fry</b>	-	-	-	○

○: Recommended method

△: Alternative method

-: Do not use

**NOTE**

- Contact LG Customer Service at 1-800-243-0000(1-888-542-2623 in Canada) if any accessories are missing
- For your safety and for extended product life, only use authorized components.
- The manufacturer is not responsible for product malfunction or accidents caused by the use of separately purchased, unauthorized components or parts.
- The images in this guide may be different from the actual components and accessories, which are subject to change by the manufacturer without prior notice for product improvement purposes.

# OPERATION

## Operating Control Panel

### Control Panel Features

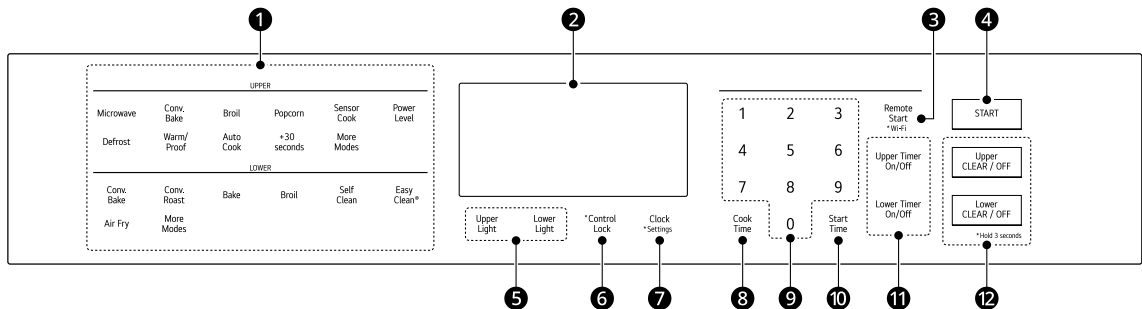

#### 1 Oven Functions

- Select various functions of the oven. See **Operating the Oven**.

#### 2 Display

Oven operation and settings appear in the display

#### 3 Remote Start / Wi-Fi

- Use to select the **Remote Start** function.
- Press and hold the button for 3 seconds to connect the appliance to a **Wi-Fi** network.

#### 4 START

Use to start all functions in either oven.

#### 5 Upper / Lower Light

- Use to turn the oven lights of the upper or lower oven on and off.

#### 6 Control Lock

- Press and hold the **Control Lock** button for three seconds to activate/deactivate **Control Lock**.

#### 7 Clock / Settings

- Use to set the time of day.
- Press and hold the button for 3 seconds to select and adjust oven settings.

#### 8 Cook Time

- Press the button to set the desired amount of time for food to cook. The oven shuts off when the set cooking time runs out.

#### 9 Number Pads

Use to set any function requiring numbers such as the time of day on the clock, the timer, the

oven temperature, the start time, and the length of operation for timed baking, etc.

#### 10 Start Time

- Press the button to set the delayed timed cook. The oven starts at the set time.

#### 11 Upper / Lower Timer On/Off

- Use to set or cancel the timer of the upper or lower oven.

#### 12 Upper / Lower CLEAR/OFF

- Use to stop cooking or cancel settings of the upper or lower oven.

### NOTE

#### • Setting the Time, Timer and Temperature

If you enter one digit of a number incorrectly, enter the entire number again to correct it. For example, if you press 1, 0, 3 and 1 to set the clock for 10:30, press 1, 0, 3 and 0 to enter the correct time.

### Energy Saving Tips

- Multiple-rack cooking saves time and energy. Whenever possible, cook foods requiring the same cooking temperature together in one oven.
- For optimal performance and energy savings, follow the guides for proper rack and pan placement.
- Reduce energy use by cleaning light oven soil with the **EasyClean** feature instead of self-clean.
- Avoid opening the oven door more than necessary during use. This helps the oven

maintain temperature, prevents unnecessary heat loss, and saves on energy use.

## Changing Settings

### Clock

The clock must be set to the correct time of day in order for the automatic oven timing functions to work properly.

- 1 Press **Clock**.
- 2 Press the numbers to set the time. For example, to set the clock for 10:30, press the numbers: **1, 0, 3** and **0**.
- 3 Press **START**.

#### NOTE

- The time of day cannot be changed during a timed baking or self-clean cycle.
- If no other buttons are pressed within 25 seconds of pressing **Clock**, the display reverts to the original setting.
- If the display time is blinking, there may have been a power failure. Reset the time.

### Oven Light

The interior oven light automatically turns on when the door is opened.

#### Upper Light

Press the **Upper Light** button to manually turn the upper oven light on.

#### Lower Light

Press the **Lower Light** button to manually turn the lower oven light on.

#### NOTE

- The lower oven light cannot be turned on if the **Self Clean** function is active.
- The oven light turns off automatically after **2 minutes and 30 seconds**.

### Timer On/Off

The Timer serves as an extra timer in the kitchen that beeps when the set time has run out. It does not start or stop cooking.

The Timer feature can be used during any of the other oven control functions.

#### For example, to set 5 minutes:

- 1 Press **Upper Timer On/Off** or **Lower Timer On/Off** once.  
0:00 appears and **Timer** flashes in the display.
- 2 Press **5**.  
0:05 appears in the display.
- 3 Press **Upper Timer On/Off** or **Lower Timer On/Off** to start the Timer. The remaining time countdown appears in the display.

#### NOTE

- If **Upper Timer On/Off** or **Lower Timer On/Off** is not pressed, the timer returns to the time of day.

- 4 When the set time runs out, **End** shows in the display. The indicator tones sound every 15 seconds until **Upper Timer On/Off** or **Lower Timer On/Off** is pressed.

#### NOTE

- If the remaining time is not in the display, recall the remaining time by pressing **Upper Timer On/Off** or **Lower Timer On/Off**.
- Press **Upper Timer On/Off** or **Lower Timer On/Off** once to set the time in hours and minutes.
- Press **Upper Timer On/Off** or **Lower Timer On/Off** twice to set the time in minutes and seconds.

### Canceling the Timer

- 1 Press **Upper Timer On/Off** or **Lower Timer On/Off** once.  
The display returns to the time of day.

## Settings (Hour Mode, Convection Auto Conversion, Oven Temperature, Display Language, Preheat Alarm Light, Beeper Volume, Fahrenheit or Celsius)

Press and hold the **Clock** button repeatedly to toggle through and change oven settings.

The **Setting** button allows you to:

- set the hour mode on the clock (12 or 24 hours)
- enable/disable convection auto conversion
- adjust the oven temperature
- select display language
- activate/deactivate the preheating alarm light
- set the beeper volume
- switch the temperature scale between Fahrenheit and Celsius

### Setting the Hour Mode

The control is set to use a 12-hour clock. To reset the clock to 24-hour mode, follow the steps below.

- 1 Press and hold the **Clock** button until  $\square \square \square$  appears in the display.
- 2 Press **1** to select a 12-hour clock, or **2** to select a 24-hour clock.
- 3 Press **START** to accept the change.

### Setting Convection Auto Conversion (Only for Lower Oven)

When **Conv. Bake** and **Conv. Roast** are selected, Convection Auto Conversion automatically converts the standard recipe temperature entered to a convection temperature by subtracting 25 °F / 14 °C. This auto converted temperature shows on the display. For example, select **Conv. Bake**, enter 350 °F, and 325 °F shows on the display after preheat.

Convection Auto Conversion is enabled by default. To change the setting, follow these instructions.

- 1 Press and hold the **Clock** button until  $\square \square \square$  appears in the display. Then press **Clock** repeatedly until  $\text{F} \square \square \square$  appears in the display.
- 2 Press **1** to enable or **2** to disable auto conversion.

- 3 Press **START** to accept the change.

### Adjusting the Oven Temperature (Only for Lower Oven)

Your new oven may cook differently from the one it replaced. Use your new oven for a few weeks to become more familiar with it before changing the temperature settings. If after familiarizing yourself with the new oven, you still think that it is too hot or too cold, you can adjust the oven thermostat yourself.

- To begin, either raise or lower the thermostat 15 °F (8 °C). Try the oven with the new setting. If the oven still needs adjustment, raise or lower the thermostat again, using the first adjustment as a gauge. For example, if the adjustment was too much, raise or lower the thermostat 10 °F (5 °C). If the adjustment was not enough, raise or lower the thermostat 20 °F (12 °C). Proceed in this way until the oven is adjusted to your satisfaction.

- 1 Press and hold the **Clock** button until  $\square \square \square$  appears in the display. Then press **Clock** repeatedly until  $\text{L} \text{-} \text{R} \square$  appears in the display.
- 2 Use the number buttons to enter the number of degrees you want to adjust the oven temperature.
- 3 Adjust the temperature either up or down by pressing **Clock** repeatedly to toggle between plus (+) or minus (-).
- 4 Press **START** to accept the change.

#### NOTE



- This adjustment does not affect the broiling or Self Clean temperatures. The adjustment is retained in memory after a power failure. The oven temperature can be increased (+) or decreased (-) as much as 35 °F or 19 °C.
- Once the temperature is increased or decreased, the display shows the adjusted temperature until it is changed.

### Selecting the Display Language

The oven control is set to display in English but can be changed to display in Spanish or French.

## 18 OPERATION

---

**1** Press and hold the **Clock** button until  appears in the display. Then press **Clock** repeatedly until  appears in the display.

**2** Press **1** for English, **2** for Spanish, or **3** for French.

**3** Press **START** to accept the change.

### Turning the Preheat Alarm Light On/Off (Only for Lower Oven)

When the oven reaches its set-temperature, the preheating alarm light flashes 5 times or until the oven door is opened.

You can activate or deactivate the preheating alarm light.

**1** Press and hold **Clock** until  appears in the display. Then press **Clock** repeatedly until **PrE** appears in the display.

**2** Press **1** to turn the light on and **2** to turn the light off.

**3** Press **START** to accept the change.

### Adjusting the Beeper Volume



**1** Press and hold **Clock** until  appears in the display. Then press **Clock** repeatedly until **BEEP** appears in the display.

**2** Press **1** for Loud, **2** for Low, and **3** for Mute.

**3** Press **START** to accept the change.

### Selecting Fahrenheit or Celsius

Set the oven temperature display to show either Fahrenheit (°F) or Celsius (°C) units. The oven defaults to Fahrenheit unless changed by the user.

**1** Press and hold **Clock** until  appears in the display. Then press **Clock** repeatedly until  appears in the display.

**2** Press **1** for °F (Fahrenheit) or **2** for °C (Celsius).

**3** Press **START** to accept the change.

### Control Lock

The Control Lock feature automatically locks most oven controls and prevents them from being turned on. It does not disable the clock, timer or the interior oven light.

**1** Press and hold **Lower CLEAR / OFF** for 3 seconds.

**2** The lock melody sounds, **CONTROL LOCKED** and the lock icon  appear in the display

**3** To deactivate the Control Lock feature, press and hold **Lower CLEAR / OFF** for 3 seconds. The unlock melody sounds and the controls unlock.

---

#### NOTE

- The **Control Lock** feature locks the control panel, but does not lock the oven door.
- 

### Start Time (Delayed Timed Cook) (Lower Oven Only)

The automatic timer of this function turns the oven on and off at the time you select. This feature can be used with the **Bake**, **Conv. Bake** and **Conv. Roast** modes.

---

#### CAUTION

- Use caution with the Delayed Timed Cook features. Use the automatic timer when cooking cured or frozen meats and most fruits and vegetables. Foods that can easily spoil, such as milk, eggs, fish, meat or poultry, should be chilled in the refrigerator first. Even when chilled, they should not stand in the oven for more than 1 hour before cooking begins, and should be removed promptly when cooking is complete. Eating spoiled food can result in sickness from food poisoning.
- 

### Setting a Delayed Timed Cook

For example, to bake at 300 °F and delay the start of baking until 4:30, first set the clock for the correct time of day.

- 1 Press **Bake**. 350 °F appears in the display.
- 2 Set the temperature: press **3**, **0** and **0**.
- 3 Press **Cook Time** and press the number buttons to set the baking time.
- 4 Press **Start Time**.
- 5 Set the start time: press **4**, **3** and **0** for 4:30.
- 6 Press **START**. A short beep sounds and the start time appears in the display. The oven begins baking at the set start time.

#### NOTE

- To cancel this function, press **Lower CLEAR/OFF** at any time.
- To change the cooking time, repeat step 3 and press **START**.
- If the oven clock is set as a 12-hour clock, you can delay the cook time for 12 hours. If the oven clock is set as a 24-hour clock, you can delay the cook time for 24 hours.

The oven will continue to cook for the set amount of time and then turn off automatically. When the cooking time has elapsed:

- The time of day shows in the display.
- The cook end indicator tone sounds every 60 seconds until **Lower CLEAR/OFF** is pressed.

## Cook Time (Timed Cook)

Set the oven to cook for a specific length of time using this function. This function can only be used with the **Bake**, **Conv. Bake**, **Conv. Roast**, **Broil** and **Favorite Mode (Lower oven) / Conv. Bake, Air Fry, Dehydrate (Upper oven)** modes.

### Setting a Timed Cook

For example, to bake at 300 °F for 30 minutes, first set the clock to the correct time of day.

- 1 Press **Bake**. 350 °F appears in the display.
- 2 Set the temperature. Press **3**, **0** and **0**.

- 3 Press **Cook Time**. **Timed** flashes in the display. **Bake**, 0:00 and 300 °F appear in the display.
- 4 Set the baking time: press **3** and **0** (for 30 minutes).
  - The baking time can be set for any amount of time between 1 minute and 11 hours and 59 minutes.

- 5 Press **START**.

The oven will continue to cook for the set amount of time and then turn off automatically. When the cooking time has elapsed:

- The time of day shows in the display.
- The cook end indicator tone sounds every 60 seconds until **CLEAR/OFF** is pressed.

### Changing the Cook Time during Cooking

For example, to change the cook time to 1 hour and 30 minutes during cooking:

- 1 Press **Cook Time**.
- 2 Change the baking time: press **1**, **3**, **0**.
- 3 Press **START** to accept the change.

## Wi-Fi

Connect the appliance to a home Wi-Fi network to use Remote Start and other smart functions. See the Smart Functions section for more details.

### Setting Up Wi-Fi

- 1 Press and hold **Remote Start** for 3 seconds.
- 2 If connected, the Wi-Fi icon  appears at the bottom of the display.

## Remote Start

Remotely starts or stops the preheating function of the appliance. The appliance must be connected to a home Wi-Fi network to use Remote Start.

### Setting Remote Start

- 1** Press **Remote Start**. The Wi-Fi icon  appears in the display.
  - In this mode, the controls for both ovens are locked.
- 2** Follow the instructions in the LG ThinQ application for using the Remote Start.

---

#### NOTE

- Remote Start is disconnected in the following situations:
    - Remote Start is never set up in the smartphone app.
    - The Remote Start status is “ready”.
    - Remote Start experiences a problem during operation.
  - The Wi-Fi icon on the display shows the status of the appliance's network connection. If the Wi-Fi icon is not lit, use the smartphone app to select the Wi-Fi network or register the product again.
  - A faulty Wi-Fi connection could delay the Remote Start function.
-

# Operating the Upper Microwave Oven

## Before Using

### WARNING

- To avoid risk of personal injury or property damage, do not use stoneware, metal cookware, or metal rimmed cookware in the oven.
- Do not use your microwave oven to cook eggs in the shell. Pressure can build up inside the shell, causing it to burst.
- Never operate the oven when it is empty. Food or water should always be in the oven during operation to absorb the microwave energy.
- Do not use the oven to dry newspapers or clothes. They may catch fire.

### NOTE

- To program the oven, press the center of each button firmly. When a button is pressed correctly, a beep sounds and the oven is activated. Do not press several buttons at once.
- Do not strike the control panel with silverware, cookware, etc. It may be damaged or broken.
- Always be careful when taking cookware out of the oven. Some dishes absorb heat from the cooked food and may be hot. See the **Cookware Guide** section for more information.
- To avoid breakage, allow cookware to cool before rinsing or submerging in water. Always allow the turntable to cool before removing it from the oven.
- Use thermometers that have been approved for microwave oven cooking.
- The turntable must always be in place when you operate the oven.

## Microwave Cookware Guide

### Microwave-Safe Cookware

Use microwavable cookware.

### WARNING

- Do not permit children to use plastic cookware without complete supervision.

### • Ovenproof Glass

- Ovenproof glassware that is treated for high intensity heat so it is heat-resistant is microwave-safe.
- Use utility dishes, loaf dishes, pie plates, cake plates, liquid measuring cups, casseroles and bowls without metal rims.
- Do not use delicate glassware, such as tumblers or wine glasses, as these might shatter when heated.

### • China

- Use bowls, cups, serving plates, pottery, stoneware, ceramics, and platters without metal rims or handles. Many containers made of these materials are microwave-safe, but test them before use.

### • Plastic

- **Plastic Storage Containers:** Use plastic dishes, cups, semi-rigid freezer containers and plastic bags only for short cooking times. Do not use them when cooking food for long periods or at high power levels, as the hot food will eventually warp or melt the plastic.
- **Plastic wrap (as a cover):** Lay the plastic wrap loosely over the dish and press it to the sides. Vent plastic wrap by turning back one edge slightly to allow excess steam to escape. The dish should be deep enough so that the plastic wrap will not touch the food. As the food heats it may melt the plastic wrap wherever the wrap touches the food.
- **Plastic Cooking Bags:** Provided they are specially made for cooking, cooking bags are microwave safe. Remember to make a slit in the bag so that steam can escape. Never use ordinary plastic bags for cooking in the microwave oven, as they will melt and rupture.
- **Plastic Microwave Cookware:** A variety of shapes and sizes of microwave cookware are available. You may be able to use items you already have on hand rather than investing in new kitchen equipment.

### • Paper

- Use paper towels, waxed paper, paper napkins, and paper plates with no metal rims or design. Look for the manufacturer's label for use in the microwave oven.
- Paper plates and containers are convenient and safe to use in the microwave oven, provided that the cooking time is short and foods to be cooked are low in fat and moisture. Paper towels are also very useful for wrapping foods and for lining baking trays in which greasy foods such as bacon are cooked.

- Avoid colored paper products as the color may run. Do not use recycled paper products in the microwave oven. They may contain impurities which could cause arcing or fires when used in the microwave.

### • **Tableware**

- Do not put plates with painted decoration in the oven, as the paint may contain metal and cause arcing.

## **Microwave-Unsafe Cookware**

### • **Metal Containers/Metal Decoration**

- Never use metal or metal-rimmed cookware in the microwave oven.
- Microwaves cannot penetrate metal. They will bounce off any metal object in the oven and cause arcing, an alarming phenomenon that resembles lightning.
- Metal shields the food from microwave energy and produces uneven cooking. Also avoid metal skewers, thermometers, foil trays, metal-rimmed or metal-banded dinnerware, casserole dishes, etc. The metal rim interferes with normal cooking and may damage the oven.

### • **Aluminum Foil**

- Avoid large sheets of aluminum foil because they hinder cooking and may cause harmful arcing.
- Use small pieces of foil to shield poultry legs and wings.
- Keep ALL aluminum foil at least 1" (2.54 cm) from the side walls and door of the oven.

### • **Wood**

- Wood bowls and boards will dry out and may split or crack when you use them in the microwave oven.
- Baskets react in the same way.

### • **Tightly Covered Cookware**

- Be sure to leave openings for steam to escape from covered containers.
- Pierce plastic pouches of vegetables or other food items before cooking.
- Tightly closed pouches could explode.

### • **Brown Paper**

- Avoid using brown paper bags.
- They absorb too much heat and could burn.

### • **Flawed or Chipped Cookware:**

- Any container that is cracked, flawed, or chipped may break in the oven.

### • **Metal Twist Ties**

- Remove metal twist ties from plastic or paper bags.
- They become hot and could cause a fire.

## **Cooking Tips**

Carefully monitor the food in the microwave oven while it is cooking. Directions given in recipes to elevate, stir, etc., are the minimum steps recommended. If food is overcooked (dry), undercooked, or unevenly cooked, make adjustments before or during cooking to correct the problem.

### • **Overcooked or Dry Food**

- **Sprinkling:** Sprinkle low-moisture foods such as roasts and vegetables with water before cooking, or cover them to retain moisture.
- **Density:** Light, porous food such as cakes and breads cook more quickly than heavy, dense foods such as roasts and casseroles.
- **Shielding:** Cover the corners of square dishes with small strips of aluminum foil to prevent overcooking. Don't use too much foil, and secure the foil to the dish. Foil can cause arcing if it gets too close to the oven walls during cooking.
- **Bones and Fat:** Bones conduct heat, and fat cooks more quickly than meat. Take care with bony or fatty cuts of meat.

### • **Undercooked Food**

- **Covering:** Cover food with a microwave-safe lid, parchment paper (not waxed paper), or plastic wrap to trap heat and steam and cook food more quickly.
- **Standing Time:** Let food stand for several minutes after it is removed from the oven to allow it to finish cooking and help flavors blend and develop.
- **Quantity:** The more food you place in the oven, the longer the required cooking time.
- **Temperature:** Ice-cold ingredients take much longer to cook than room temperature ingredients.

### • **Unevenly Cooked Food**

- **Stirring:** Stir food from the outside toward the center during cooking, as food at the outside of the dish heats more quickly.
- **Arranging:** Turn food over several times during cooking. The upper portions of thick foods cook more quickly than the lower portions. Thick or dense foods can be elevated

so that microwaves can be absorbed by the underside and center of the foods.

- **Shaping:** Place the thickest portions of foods like meat, poultry or fish toward the outside of the cookware to help them cook more evenly. If possible, shape foods into thin rounds or rings.
- **Foods with Skin, Shell or Membrane**
  - **Skin or Membrane:** Pierce the outsides of foods like potatoes, sausages, or egg whites or yolks before cooking.
  - **Shell:** Pierce or remove the shells from eggs, clams, oysters, or other shelled foods before cooking.
- **Testing if Cooked**
  - Microwaves cook food quickly, so test food for doneness frequently. Some foods are left in the microwave until completely cooked, but most foods, including meats and poultry, should be removed from the oven while still slightly undercooked and allowed to finish cooking during standing time. The internal temperature of foods will rise between 5 °F (3 °C) and 15 °F (8 °C) during standing time.
- **Defrosting Tips**
  - Remove fish, shellfish, meat, and poultry from their original wrapping paper or plastic package. Otherwise, the wrap close to the food will hold steam and heat, which can cause the outer surface of the food to be cooked.
  - Remove any metal twist ties.
  - Always slit or pierce plastic pouches or packaging.
  - Open containers such as cartons before they are placed in the oven.
  - If food is foil wrapped, remove the foil and place the food in a suitable container.
  - The length of defrosting time varies depending on the shape of the food and on how solidly the food is frozen.
  - As food begins to defrost, separate the food into pieces so that they can defrost more easily.
  - Turn over food during defrosting or standing time. Separate into pieces and remove food as required.
  - Let food stand after defrosting. Food should still be somewhat icy in the center when removed from the oven.
  - When using Defrost, the weight to be entered is the net weight in pounds and tenths of pounds (the weight of the food minus the container).
- Slit the skins of frozen food such as sausage.
- Bend plastic pouches of food to ensure even defrosting.
- Place food in a shallow container or in a microwave roasting dish to catch the drippings.
- Always underestimate defrosting time. Food should still be somewhat icy in the center when removed from the oven. If defrosted food is still frozen solid in the center, return it to the upper oven for more defrosting.
- Depending on the shape of the food, some areas may defrost more quickly than others.
- The shape of the package affects how quickly food will defrost. Shallow packages will defrost more quickly than a deep block.
- For best results, shape ground meat into the form of a doughnut before freezing. When defrosting, scrape off thawed meat when the beep sounds and continue defrosting.
- Use small pieces of aluminum foil to shield parts of food such as chicken wings, leg tips, fish tails, or areas that start to get warm. Make sure the foil does not touch the sides, top, or bottom of the oven. The foil can damage the oven lining.

## Microwave Power Levels

This microwave oven is equipped with 10 power levels to give you maximum flexibility and control over cooking.

Power Level	Use
<b>10</b> (100%)	<ul style="list-style-type: none"> <li>• Boiling water</li> <li>• Browning ground beef</li> <li>• Making candy</li> <li>• Cooking whole poultry, poultry pieces, fish &amp; vegetables</li> <li>• Cooking tender cuts of meat</li> </ul>
<b>9</b> (90%)	<ul style="list-style-type: none"> <li>• Reheating rice, pasta &amp; vegetables</li> </ul>
<b>8</b> (80%)	<ul style="list-style-type: none"> <li>• Reheating prepared foods quickly</li> <li>• Reheating sandwiches</li> </ul>
<b>7</b> (70%)	<ul style="list-style-type: none"> <li>• Cooking egg, milk and cheese dishes</li> <li>• Cooking cakes and breads</li> <li>• Melting chocolate</li> </ul>

Power Level	Use
<b>6</b> (60%)	<ul style="list-style-type: none"> <li>• Cooking veal</li> <li>• Cooking whole fish</li> <li>• Cooking puddings and custard</li> </ul>
<b>5</b> (50%)	<ul style="list-style-type: none"> <li>• Cooking ham, whole poultry and lamb</li> <li>• Cooking rib roast and sirloin tip</li> </ul>
<b>4</b> (40%)	<ul style="list-style-type: none"> <li>• Thawing meat, poultry and seafood</li> </ul>
<b>3</b> (30%)	<ul style="list-style-type: none"> <li>• Cooking less tender cuts of meat</li> </ul>
<b>2</b> (20%)	<ul style="list-style-type: none"> <li>• Taking chill out of fruit</li> <li>• Softening butter</li> </ul>
<b>1</b> (10%)	<ul style="list-style-type: none"> <li>• Keeping casseroles and main dishes warm</li> <li>• Softening butter and cream cheese</li> </ul>

## Microwave Mode

### Cooking at High Power Level

**Example: To cook food for 8 minutes 30 seconds.**

- 1 Press **Microwave**.
- 2 Set the cook time: Press **8, 3** and **0**.
- 3 Press **START** to start cooking.
  - When the cook time is over a melody sounds.

### Cooking at Lower Power Levels

High power cooking does not always give the best results with foods that need slower cooking, such as roasts, baked goods, or custards. The oven has 9 power settings in addition to HIGH.

**Example: To cook food for 7 minutes 30 seconds at 70% power.**

- 1 Press **Microwave**.

- 2 Set the cook time: Press **7, 3** and **0**.
- 3 Set the power level: Press **Power Level** and **7**.
- 4 Press **START** to start cooking.
  - When the cook time is over a melody sounds.

### +30 Seconds Mode

Use this to quickly add 30 seconds to microwave cooking time.

- 1 Press the button when the oven is off to immediately start the microwave function for 30 seconds at High power.
- 2 When cooking has finished or to cancel, Press **Upper CLEAR/OFF**.

## Defrost Mode

The oven has 4 preset defrost modes. The Defrost Menu shows the suggested defrost mode for various foods. This defrost function conveniently chimes during the mode to remind you to check, turn over, separate, or rearrange the food.

- **1:** Meat mode
- **2:** Poultry mode
- **3:** Fish mode
- **4:** Bread mode

### Setting the Defrost Function

**Example: To defrost 1.2 pounds of meat**

- 1 Press **Defrost** once.
- 2 Press **1** to select meat mode.
- 3 Set the weight: Press **1, 2**. (for 1.2 lbs)
- 4 Press **START** to start defrosting.

## 5 When defrosting is complete, press **Upper CLEAR/OFF**.

### NOTE

- The countdown appears in the display after **START** is pressed. The oven chimes once during the defrost cycle.
- At the chime, open the oven door and turn the food over. Remove any food that has thawed. Return the still frozen items to the oven and press **START** to complete the defrost cycle.

## Weight Conversion Table

Most food weights are given in pounds and ounces. If using pounds, food weights must be entered into Auto Defrost in pounds and tenths of pounds (decimals).

Use the following table if necessary to convert food weights to decimals.

Ounces	Decimal Weight
1.6	0.1
3.2	0.2
4.8	0.3
6.4	0.4
8.0	0.5 (One-half pound)
9.6	0.6
11.2	0.7
12.8	0.8
14.4	0.9
16.0	1.0 (One pound)

## Defrost Menu

Refer to the information below to set the desired code and weight.

### Meat (0.1 - 6.0 lbs)

- Beef: Ground beef, round steak, stew cubes, tenderloin steak, pot roast, rib roast, rump roast, chuck roast, hamburger patties
- Lamb: Chops, rolled roast
- Pork: Chops, hot dogs, spareribs, country-style ribs, rolled roast, sausage
- Veal: Cutlets (1 lb., ½ inch thick)
- Turn food over at beep.
- Standing time: 5-15 minutes

### Poultry (0.1 - 6.0 lbs)

- Poultry: Whole, cut-up, breast (boneless)
- Cornish Hens: Whole
- Turkey: Breast
- Rinse chicken with tap water and let stand for 60 minutes after defrosting for better results.
- Turn food over at beep.
- Standing time: 60 minutes

### Fish (0.1 - 4.0 lbs)

- Fish: Fillets, whole steaks
- Shellfish: Crab meat, lobster tails, shrimp, scallops
- Turn food over at beep.
- Standing time: 5-10 minutes

### Bread (0.1 - 2.0 lbs)

- Sliced bread, buns, baguettes, etc.
- Separate slices and place between paper towels or on flat plate. Turn food over at beep.
- Standing time: 1-2 minutes

## Sensor Cook Mode

### About Features

This function reheats favorite foods without selecting cooking times and power levels. The oven automatically determines required cooking time for each food item. When the internal sensor detects a certain amount of humidity coming from the food, it tells the oven how much longer to heat.

The display shows the remaining heating time. For best results when sensor cooking, follow these recommendations.

- Food cooked with the sensor system should be at normal storage temperature.
- The glass tray and the outside of the container should be dry to assure best cooking results.
- Foods should always be covered loosely with microwavable plastic wrap, waxed paper, or a lid.
- Do not open the door or press **Upper CLEAR/OFF** during the sensing time. When sensing time is over, the oven beeps and the remaining cooking time will appear in the display window. At this time you can open the door to stir, turn, or rearrange the food.

Appropriate containers and coverings help assure good sensor cooking results.

- Always use microwavable containers and cover them with lids or vented plastic wrap.
- Never use tight-sealing plastic covers. They can prevent steam from escaping and cause food to overcook.
- Match the amount to the size of the container. Fill containers at least half full for best results.
- Be sure the outside of the cooking container and the inside of the upper oven are dry before placing food in the oven. Beads of moisture turning into steam can mislead the sensor.

## Setting the Sensor Cook Function

### Example: To sensor cook rice

- 1** Press **Sensor Cook**.
- 2** Press **7** to select RICE.
- 3** Press **START**.
  - When the cook time is over a melody sounds.

## Sensor Cook Menu

Refer to the information below to set the desired menu item and see the recommended amounts.

- **1. Beverage** (1 - 2 cups)
  - Cookware: Mug or microwave-safe cup on the glass tray
  - Food temperature: Room
  - Instructions: Use microwave safe mug or cup without covering. After cooking, stir to complete reheating.
- **2. Casserole** (10-20 oz)
  - Cookware: Microwave-safe bowl on the glass tray
  - Food temperature: Refrigerated
  - Instructions: Use microwave safe bowl. Cover container with vented plastic wrap. After cooking, let stand for 3 minutes.
- **3. Chicken** (16-20 oz)
  - Cookware: Microwave-safe bowl on the glass tray
  - Food temperature: Refrigerated
  - Instructions: Use microwave safe bowl. Cover container with vented plastic wrap. After cooking, let stand for 3 minutes.

- **4. Pasta** (½-2 cups<sup>†</sup>)
  - Cookware: Microwave-safe bowl on the glass tray
  - Food temperature: Refrigerated (precooked)
  - Instructions: Use microwave safe bowl. Cover container with vented plastic wrap. After cooking, let stand for 3 minutes.
- **5. Pizza** (1-3 slices)
  - Cookware: Microwave-safe bowl on the glass tray
  - Food temperature: Refrigerated
  - Instructions: This is a reheat function for leftover pizza. Use microwave safe plate without covering.
- **6. Plate of food** (1 serving)
  - Cookware: Microwave-safe bowl on the glass tray
  - Food temperature: Refrigerated
  - Instructions: Use microwave safe bowl. Cover container with vented plastic wrap. After cooking, let stand for 3 minutes.
- **7. Rice** (½-2 cups<sup>†</sup>)
  - Cookware: Microwave-safe bowl on the glass tray
  - Food temperature: Refrigerated (precooked)
  - Instructions: Use microwave safe bowl. Cover container with vented plastic wrap. After cooking, let stand for 3 minutes.
- **8. Soup** (1-4 cups<sup>†</sup>)
  - Cookware: Microwave-safe bowl on the glass tray
  - Food temperature: Room
  - Instructions: Use microwave safe bowl. Cover container with vented plastic wrap. After cooking, let stand for 3 minutes.
- **9. Vegetable** (1-4 cups<sup>†</sup>)
  - Cookware: Microwave-safe bowl on the glass tray
  - Food temperature: Refrigerated
  - Instructions: Use microwave safe bowl. Cover container with vented plastic wrap. After cooking, let stand for 3 minutes.

## WARNING

- Be careful when handling the container. Microwave heating of beverages can result in delayed eruptive boiling. Therefore, care must be taken when handling the container.

† 8 oz (240 ml) per cup

## Convection Bake Mode

During Convection Bake, a heating element is used to raise the temperature of the air inside the oven. The convection cooking temperature ranges from 100 °F (38 °C) to 450 °F (232 °C). It is best to preheat the oven when convection cooking.

### NOTE

- Reduce oven temperature by 25 °F from the temperature recommended on packaged foods. The baking time may vary according to the food condition or individual preference.

## Setting the Convection Bake Function

### Example: 45 minutes at 375 °F (191 °C) with preheating

- 1 Press **Conv. Bake**. The display flashes 350 °F.
- 2 Set the oven temperature: Press **3, 7** and **5**.
- 3 Press **START**. The oven starts to preheat and the display shows the oven temperature. (Do not enter the time.)
- 4 When the melody sounds, place the food in the oven.
- 5 Press **Cook Time**.
- 6 Set the cook time: Press **4, 5**.
- 7 Press **START**.
- 8 When cooking is complete, Press **Upper CLEAR/OFF**.

### Example: 30 minutes at 375 °F (191 °C) without preheating

- 1 Press **Conv. Bake**. The display flashes 350 °F.

- 2 Set the oven temperature: Press **3, 7** and **5**.
- 3 Press **Cook Time**.
- 4 Set the cook time: Press **3, 0**.
- 5 Press **START**.
- 6 When cooking is complete, Press **Upper CLEAR/OFF**.

### NOTE

- When the oven reaches the set preheat temperature, a melody will sound. The oven automatically holds that temperature for 30 minutes.
- The oven temperature drops very quickly when the door is opened; however, this should not prevent food from being fully cooked during normal cooking time.

## Broil Mode

This feature will allow you to brown and crisp food quickly. There is no need for preheating.

## Setting the Broil Function

### Example: Broiling for 1 minute 30 seconds

- 1 Press **Broil**.
- 2 Set the cook time: Press **1, 3** and **0**.
- 3 Press **START**. The oven begins to heat.
- 4 When cooking is complete, Press **Upper CLEAR/OFF**.

### ⚠ CAUTION

- Always use oven gloves when removing the food and accessories after cooking as the oven & accessories will be very hot.

**NOTE**

- For best results, use the rack when broiling in the upper oven.

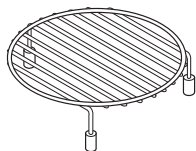
**Popcorn Mode**

Prepare microwave popcorn simply and easily, one bag at a time.

- Place one bag only (50 - 100g) of prepackaged microwave popcorn on a microwave-safe / oven-safe dish on the turntable. The package should be at room temperature.

- 1** Press **Popcorn** once.
- 2** Press **START** to start cooking.
- 3** Press **Upper CLEAR/OFF** to cancel **Popcorn** at any time.

**CAUTION**

- Never use a brown paper bag for popping corn or attempt to pop leftover kernels.
- Do not pop popcorn, except in a microwave-safe container or commercial packages designed for microwave ovens.
- Never try to pop popcorn in a paper bag that is not microwave-approved.
- Overcooking may result in the popcorn being burnt and smoking badly.
- Do not repop unpopped kernels in the microwave.
- Do not reuse popcorn bags.
- Listen while corn pops. Stop oven when popping slows to 2-3 seconds between pops.
- Do not leave microwave unattended while popping corn.
- Follow directions on bag.

**NOTE**

- When popping prepackaged popcorn, place the bag carefully in the oven so it does not touch the

walls as it rotates. Fold the ends of the bag up and toward the center of the bag.



- If popcorn bag size is not known, follow manufacturer's instructions and do not use this feature.
- Do not use **Popcorn** button in combination with any other feature buttons.
- Do not attempt to reheat or cook any unpopped kernels.
- Do not reuse bag. Overcooking can result in an oven fire.
- Prepare only one bag at a time.
- Do not use popcorn popping devices in microwave oven with this feature.
- Do not leave microwave unattended while cooking popcorn.

**Warm Mode**

This function maintains an oven temperature of less than 230 °F. This function should not be used to reheat cold food. This function keeps cooked food warm for serving up to 3 hours after cooking has finished. After 3 hours this function shuts the oven OFF automatically.

**Setting the Warm Mode**

- 1** Press **Warm / Proof**.
- 2** Press **1** to select the Warm mode.
- 3** Select the temperature level: Press **1** for low, **2** for medium, or **3** for high.
  - Low: 140 °F - 160 °F (60 °C - 71 °C)
  - Medium: 160 °F - 195 °F (71 °C - 91 °C)
  - High: 195 °F - 230 °F (91 °C - 110 °C)
- 4** Press **START** to enter choice.

- 5 Select the type: Press **1** for moist, **2** for crisp.
- 6 Press **START** to start.
- 7 Press **Upper CLEAR/OFF** at any time to cancel.

---

#### NOTE

- This function is intended to keep food warm. Do not use it to cool food down.
  - It is normal for the fan to operate during this function.
- 

### Proof Mode

This function maintains a warm oven for rising yeast-leavened products before baking.

#### Setting the Proof Mode

- 1 Press **Warm / Proof**.
- 2 Press **2** to select the Proof mode.
- 3 Press **START** to start.
- 4 Press **Upper CLEAR/OFF** at any time to cancel.

---

#### NOTE

- To avoid lowering the oven temperature and lengthening proofing time, do not open the oven door unnecessarily.
  - Check bread products early to avoid over-proofing.
  - Do not use the Proofing mode for warming food or keeping food hot. The proofing oven temperature is not hot enough to hold foods at safe temperatures. Use the Warm function to keep food warm.
  - Proofing will not operate if the oven is too hot. Allow the oven to cool before proofing.
- 

### Auto Cook Mode

Use this function to heat common prepared foods without selecting cooking times and power levels.

This function has preset programs for 28 food items.

#### Setting the Auto Cook Mode

- 1 Press **Auto Cook**.
- 2 Select the food item: Press **1** for bacon.
- 3 Press **START** to enter choice.
- 4 Set the weight or amount: Press **1** to select 3-4 slices of bacon.
- 5 Press **START** to begin cooking.

#### Auto Cook Menu

Refer to the information below to set the desired menu item and see the recommended amounts.

- **1. Regular sliced bacon** (3-4 or 5-6 slices)
  - **Cookware:** Microwave-safe bacon rack or plate on the glass tray
  - **Food temperature:** Refrigerated
  - **Instructions:** Place bacon slices on a microwave rack for best results. Use a plate lined with paper towels if rack is not available.
- **2. Bagels** (1 or 2-3 bagels)
  - **Cookware:** Metal tray
  - **Food temperature:** Frozen
- **3. Baked Potatoes** (1, 2, 3-4 potatoes (7-9 oz/ea))
  - **Cookware:** Metal tray
  - **Food temperature:** Room
  - **Instructions:** Pierce each potato several times with a fork.
- **4. Brownie** (8" X 8", 9" X 13")
  - **Cookware:** Microwave-safe cookware on the glass tray
  - **Food temperature:** Room
  - **Instructions:** Spray microwave-safe glass or silicone bakeware with cooking spray. Pour batter into bakeware, spreading it evenly. After cooking, allow to rest for a few minutes.
- **5. Cod fillets** (1 lb)
  - **Cookware:** Metal tray
  - **Food temperature:** Refrigerated

- **Instructions:** Brush with oil and season with salt and pepper. Turn food over at the beep.
- **6. Corn dog** (1-2, 3-4)
  - **Cookware:** Metal tray
  - **Food temperature:** Frozen
- **7. Fresh vegetable** (4-6, 7-9, 10-12, 13-15, 16-20 oz)
  - **Cookware:** Microwave-safe glass or silicone bakeware on the glass tray
  - **Food temperature:** Refrigerated
  - **Instructions:** Add water according to the quantity (4-12 oz: add 2 tbsp water, 13-20 oz: add 4 tbsp water). Cover with vented plastic wrap. After cooking, stir and let stand for 3 minutes.
- **8. Frozen chicken nuggets** (1-2, 3-4 servings (3.5 oz / 100 g per serving))
  - **Cookware:** Metal tray
  - **Food temperature:** Frozen
  - **Instructions:** Turn food over at the beep.
- **9. Frozen chicken wings** (1-2, 3-4 servings (3.5 oz / 100 g per serving))
  - **Cookware:** Metal tray
  - **Food temperature:** Frozen
  - **Instructions:** Turn food over at the beep.
- **10. Frozen fries** (1-2, 3-4 servings (3.5 oz / 100 g per serving))
  - **Cookware:** Metal tray
  - **Food temperature:** Frozen
  - **Instructions:** Turn food over at the beep.
- **11. Frozen pizza, Regular crust** (Individual: 6", Regular: 12")
  - **Cookware:** Metal tray
  - **Food temperature:** Frozen
- **12. Frozen soft pretzels** (1, 2, 3-4 pretzels)
  - **Cookware:** Metal tray
  - **Food temperature:** Frozen
- **13. Frozen vegetables** (4-6, 7-9, 10-12, 13-15, 16-20 oz)
  - **Cookware:** Microwave-safe bowl on the glass tray
  - **Food temperature:** Frozen
  - **Instructions:** Add water according to the quantity (4-12 oz: add 2 tbsp water, 13-20 oz: add 4 tbsp water). Cover with vented plastic wrap. After cooking, stir and let stand for 3 minutes.
- **14. Garlic bread, sliced and frozen** (1-2, 3-4, 5-6 pieces)
  - **Cookware:** Metal tray
  - **Food temperature:** Frozen
  - **Instructions:** Turn food over at the beep.
- **15. Hamburger, 1/2" thick** (2, 3-4, 5-6 patties)
  - **Cookware:** Metal tray
  - **Food temperature:** Refrigerated
  - **Instructions:** Turn food over at the beep.
- **16. Lamb chops, 1/2" thick (6-7 oz)** (1, 2, 3-4 chops)
  - **Cookware:** Metal tray
  - **Food temperature:** Refrigerated
  - **Instructions:** Brush with oil and season with salt and pepper. Turn food over at the beep.
- **17. Meat loaf** (9" X 5")
  - **Cookware:** Microwave-safe glass or silicone bakeware on the glass tray
  - **Food temperature:** Refrigerated
  - **Ingredients:**  
Ground meat: 28 oz / 800 g, Egg (refrigerated: 4 oz / 115 g, Salt: 1/2 tsp / 2 g)
  - **Instructions:** Place meat mixture into microwave-safe 9" x 5" glass or silicone bakeware.
- **18. Nachos** (1-3, 4-6 servings (8 ea / 1 serving))
  - **Cookware:** Metal tray
  - **Food temperature:** Room
- **19. Oatmeal** (1, 2 servings)
  - **Cookware:** Large microwave-safe bowl on the glass tray
  - **Food temperature:** Room
  - **Ingredients:**  
1 Serving: Oats 1/2 cup (40 g), Water or Milk 1 cup (230 g), Salt (Optional) dash  
2 Servings: Oats 1 cup (80 g), Water or Milk 1 1/2 cups (345 g), Salt (Optional) 1/8 tsp
  - **Instructions:** Combine water or milk, salt and oats in a large microwave-safe bowl. Cover with vented plastic wrap. After cooking, let stand for 3 minutes.
- **20. Pork chops, 1/2" thick** (1, 2, 3-4 chops)
  - **Cookware:** Metal tray
  - **Food temperature:** Refrigerated
  - **Instructions:** Brush with oil and season with salt and pepper. Turn food over at the beep.

- **21. Quinoa** (1, 2 generous servings)
  - **Cookware:** Microwave-safe bowl on the glass tray
  - **Food temperature:** Room
  - **Ingredients:**
    - 1 Serving: Quinoa 1/2 cup (40 g), Water or Milk 1 cup (230 g), Salt (Optional) dash
    - 2 Servings: Quinoa 1 cup (80 g), Water or Milk 1 1/2 cups (345 g), Salt (Optional) 1/8 tsp
  - **Instructions:** Combine water or milk, salt and quinoa in a large microwave-safe bowl. Cover with vented plastic wrap. After cooking, let stand for 3 minutes.
- **22. Ribeye steak, 1" thick (14-15 oz)** (1, 2 steaks)
  - **Cookware:** Metal tray
  - **Food temperature:** Refrigerated
  - **Instructions:** Brush with oil and season with salt and pepper. Turn food over at the beep.
- **23. Rice** (1/2, 1 cup)
  - **Cookware:** Deep and large microwave-safe bowl on the glass tray
  - **Food temperature:** Room
  - **Ingredients:**
    - Rice: 1/2 cup (96 g), 1 cup (192 g)
    - Water: 1 cup (230 g), 2 cups (460 g)
    - Salt: Optional
  - **Instructions:** Cover with vented plastic wrap. After cooking, let stand for 5-10 minutes.
- **24. Salmon steak, 1" thick** (1, 2, 3-4 steaks)
  - **Cookware:** Metal tray
  - **Food temperature:** Refrigerated
  - **Instructions:** Brush with oil and season with salt and pepper. Turn food over at the beep.
- **25. Sausage** (1-6, 7-14 links)
  - **Cookware:** Metal tray
  - **Food temperature:** Refrigerated
  - **Instructions:** Turn food over at the beep.
- **26. Sirloin steak, 1" thick (18-21 oz)** (1, 2 steaks)
  - **Cookware:** Metal tray
  - **Food temperature:** Refrigerated
  - **Instructions:** Brush with oil and season with salt and pepper. Turn food over at the beep.
- **27. Tenderloin** (3/4, 1 1/2 lb)
  - **Cookware:** Metal tray
  - **Food temperature:** Refrigerated
  - **Instructions:** Brush with oil and season with salt and pepper. Turn food over at the beep.

- **28. Canned vegetables** (4-6, 7-9, 10-12, 13-15, 16-20 oz)
  - **Cookware:** Microwave-safe bowl on the glass tray
  - **Food temperature:** Room
  - **Instructions:** Transfer canned vegetables to microwave-safe bowl. Cover with vented plastic wrap. After cooking, stir and let stand for 3 minutes.

### WARNING

- Do not use recycled paper products in the upper oven. They sometimes contain impurities that cause arcing and sparking.
- NEVER use paper products in the convection oven.

## More Modes (Soften, Melt, Air Fry, Dehydrate)

The oven has 4 preset modes. The More Mode menu shows the suggested mode for various foods.

- **1:** Soften mode
- **2:** Melt mode
- **3:** Air Fry
- **4:** Dehydrate

## Setting the Soften Mode

The oven uses low power to soften foods such as butter, cream cheese, frosting, and ice cream. See the following menu guide.

### Example: 1 pint of ice cream

- 1** Press **More Mode**.
- 2** Press **1** to select the Soften mode.
- 3** Set the menu: Press **4** for ice cream.
- 4** Press **START** to enter choice.
- 5** Set the weight or amount: Press **1** to select 1 pint.

- 6** Press **START** to begin heating.

### Soften Menu

- **1. Butter** (½, 1, 2 sticks)
  - **Cookware:** Microwave-safe dish on the glass tray
  - **Food temperature:** Refrigerated
  - **Instructions:** Press **1** for 1/2 stick, **2** for 1 stick, or **3** for 2 sticks. Butter will be at room temperature and ready for use in a recipe.
- **2. Cream cheese** (3, 8 oz)
  - **Cookware:** Microwave-safe dish on the glass tray
  - **Food temperature:** Refrigerated
  - **Instructions:** Press **1** for 3 oz or **2** for 8 oz. Cream cheese will be at room temperature and ready for use in a recipe.
- **3. Frosting** (16 oz)
  - **Cookware:** Microwave-safe dish on the glass tray
  - **Food temperature:** Refrigerated
  - **Instructions:** Frosting will be at room temperature and ready for use in a recipe.
- **4. Ice cream** (1 pint, 1 quart)
  - **Cookware:** Glass tray
  - **Food temperature:** Frozen
  - **Instructions:** Remove lid and cover. Press **1** for 1 pint or **2** for 1 quart. Ice cream will be soft enough to make scooping easier.

### Setting the Melt Mode

The oven uses low power to melt foods such as butter, caramel, cheese, chocolate, and marshmallows. See the following menu guide.

#### Example: 8 oz of chocolate.

- 1** Press **More Mode**.
- 2** Press **2** to select the Melt mode.
- 3** Set the menu: Press **4** for chocolate.
- 4** Press **START** to enter choice.

- 5** Set the weight or amount: Press **2** to select 8 oz.

- 6** Press **START** to begin heating.

### Melt Menu

- **1. Butter** (½, 1, 2 sticks)
  - **Cookware:** Microwave-safe bowl on the glass tray
  - **Food temperature:** Refrigerated
  - **Instructions:** Press **1** for 1/2 stick, **2** for 1 stick, or **3** for 2 sticks. After heating, stir to complete melting.
- **2. Caramel** (4, 8, 12 oz)
  - **Cookware:** Microwave-safe bowl on the glass tray
  - **Food temperature:** Room
  - **Instructions:** Press **1** for 4 oz, **2** for 8 oz, or **3** for 12 oz. After heating, stir to complete melting.
- **3. Cheese** (4, 8, 12 oz)
  - **Cookware:** Microwave-safe bowl on the glass tray
  - **Food temperature:** Refrigerated
  - **Instructions:** Use processed cheese food only. Cut into cubes. Press **1** for 4 oz, **2** for 8 oz, or **3** for 12 oz. After heating, stir to complete melting.
- **4. Chocolate** (4, 8, 12 oz)
  - **Cookware:** Microwave-safe bowl on the glass tray
  - **Food temperature:** Room
  - **Instructions:** Chocolate chips or squares of baking chocolate may be used. Press **1** for 4 oz, **2** for 8 oz, or **3** for 12 oz. After heating, stir to complete melting.
- **5. Marshmallow** (5, 10 oz)
  - **Cookware:** Microwave-safe bowl on the glass tray
  - **Food temperature:** Room
  - **Instructions:** Press **1** for 5 oz, **2** for 10 oz. After cooking, stir to complete heating.

### Setting the Air Fry Mode

The Air Fry function is specially designed for oil free frying. This function allows you to manually select the temperature and cook time. To automatically air fry common foods, select the Air Fry mode under More Modes. Air Fry temperatures range from 300 °F to 425 °F.

**Example: Air Frying for 9 minutes 30 seconds at 425 °F**

- 1** Press **More Mode**.
- 2** Press **3** to select the Air Fry mode. 400 °F appears in the display.
- 3** Press numbers to set the oven temperature.
- 4** Press **Cook Time** and press numbers to set the cook time.
- 5** Press **START** to begin heating.
- 6** Press **Upper CLEAR/OFF** at any time to cancel.

**Air Fry Menu**

- Arrange food evenly in a single layer.
- For best results, turn food over 1 - 2 times during cooking.
- Cookware: Air Fry Pan on the rack on the metal tray
- **Fresh shrimp** (6 - 12 oz)
  - Set temp / Time (minutes): 425 °F / 17 - 23
- **Frozen chicken nuggets** (5 - 10 oz)
  - Set temp / Time (minutes): 425 °F / 14 - 18
- **Frozen chicken tenders** (6 - 14 oz)
  - Set temp / Time (minutes): 425 °F / 20 - 25
- **Frozen chicken wings** (5 - 18 oz)
  - Set temp / Time (minutes): 425 °F / 21 - 26
- **Frozen churros** (4 - 8 oz)
  - Set temp / Time (minutes): 375 °F / 10 - 13
- **Frozen french fries** (5 - 10 oz)
  - Set temp / Time (minutes): 425 °F / 17 - 23
- **Homemade french fries** (6 - 12 oz)
  - Set temp / Time (minutes): 425 °F / 17 - 23
- **Homemade potato wedges** (8 - 16 oz)
  - Set temp / Time (minutes): 425 °F / 20 - 27
- **Mixed vegetable** (6 - 12 oz)
  - Set temp / Time (minutes): 400 °F / 17 - 23

**Setting the Dehydrate Mode**

Use this function to dry fruit, vegetables, and beef to create healthy and nutritious snacks without using chemicals and preservatives. Place parchment paper on the metal tray and spread the food in a single layer. Dehydrate temperatures range from 100 °F to 200 °F.

**Example: Dehydrating for 5 hours at 140 °F**

- 1** Press **More Mode**.
- 2** Press **4** to select the Dehydrate mode. 160 °F appears in the display.
- 3** Set the oven temperature: Press **1, 4, 0**.
- 4** Set the cook time: Press **Cook Time** and press **5, 0** and **0**. **HR** appears in the time display.
- 5** Press **START**. The oven begins to dehydrate.
- 6** Press **Upper CLEAR/OFF** to cancel at any time or when cooking is complete.

**Dehydrate Menu**

- **Bananas**
  - Preparation: Cut into 1/4" (5 - 6 mm) slices.
  - Set temp / Time: 160 °F / 5 - 8 hrs
  - Use: Snacks, baby food, granola, cookies and banana bread
- **Figs**
  - Preparation: Remove stems and halve.
  - Set temp / Time: 160 °F / 8 - 9 hrs
  - Use: Fillings, cakes, puddings, bread and cookies
- **Kiwi**
  - Preparation: Peel and cut into 3/8" (8 - 12 mm) slices.
  - Set temp / Time: 160 °F / 5 - 8 hrs
  - Use: Snacks
- **Mangos**
  - Preparation: Remove skin and cut into 3/8" (6 - 10 mm) slices.
  - Set temp / Time: 160 °F / 6 - 9 hrs
  - Use: Snacks, cereals, baked goods

## 34 OPERATION

---

- **Pineapple**

- Preparation: Peel, core and cut into 3/8" (8 - 12 mm) slices.
- Set temp / Time: 160 °F / 6 - 9 hrs
- Use: Snacks, baked goods, baked granola

- **Tomatoes**

- Preparation: Wash and slice into 1/4" (6 mm) thick circles.
- Set temp / Time: 160 °F / 6 - 9 hrs
- Use: Soups, stews, paste or sauce

- **Mushrooms**

- Preparation: Clean with soft brush or cloth. Don't wash.
- Set temp / Time: 140 °F / 4 - 8 hrs
- Use: Rehydrate for soups, meat dishes, omelettes or frying

- **Beef jerky**

- Preparation: Cut meat into 1/4" (5 - 6 mm) thick slices and marinate for 6 - 8 hours in the refrigerator.
- Set temp / Time: 175 °F / 6 - 9 hrs
- Use: Snacks

# Operating the Lower Oven

## Before Using the Oven

### NOTE

- Because the oven temperature cycles, an oven thermometer placed in the oven cavity may not show the same temperature that is set on the oven.
- It is normal for the convection fan to run while preheating during a regular bake cycle.
- The convection fan motor may run periodically during a regular bake cycle.
- If the door is left open for longer than 30 seconds during baking, the heater turns off. The heater turns back on automatically once the door is closed.
- Avoid opening the oven door more than necessary during use. This helps the oven maintain temperature, prevents unnecessary heat loss, and saves on energy use.

## Oven Vent

Areas near the vent may become hot during operation and may cause burns. Avoid placing plastics near the vent as heat may distort or melt the plastic.

It is normal for steam to be visible when cooking foods with high moisture content.

### ⚠ WARNING

- Do not block the vent opening at the bottom of the oven.

## Using Heavy Duty Oven Racks

The racks have a turned-up back edge that prevents them from being pulled out of the oven cavity.

### ⚠ CAUTION

- Reposition oven racks before turning the oven on to prevent burns.
- Do not cover the racks with aluminum foil, or any other material, or place anything on the bottom of the oven. Doing so will result in poor baking and may damage the oven bottom.
- Only arrange oven racks when the oven is cool.
- Do not place objects heavier than 33 lb (15 kg) on the racks. Do not place heavy objects on the

corners of the racks. Doing so can damage the racks.

## Removing Racks

- 1 Pull the rack straight out until it stops.
- 2 Lift up the front of the rack and pull it out.

## Replacing Racks

- 1 Place the end of the rack on the support.
- 2 Tilt the front end up and push the rack in.

## Using Gliding Oven Racks

The optional gliding racks slide in and out on a frame. This keeps heavy cookware level and prevents it from sliding forward when the rack is completely extended.

### ⚠ CAUTION

- Place oven racks in the desired location before turning on the oven to avoid burns.
- Do not cover the racks with aluminum foil, or any other material, or place anything on the bottom of the oven. Doing so will result in poor baking and may damage the oven bottom.

## Installing Gliding Racks

- 1 Start with the rack in the closed position. Hold the rack with one hand at the center front and the other hand at the back right corner.
- 2 Carefully insert the rack between the rack guides, and slide it back until the shelf drops into place.

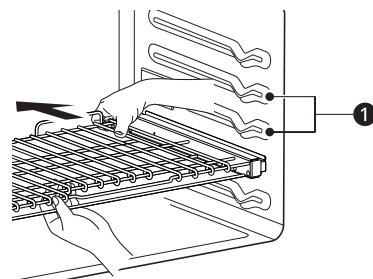

### 1 Rack Guides

- 3 Once the rack is secured in the back, pull the entire rack forward until the rack locks into place.

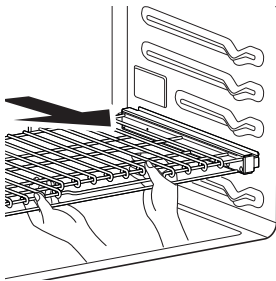

### Removing Gliding Racks

- 1 With the rack in the closed position, grasp the front of the rack and frame and lift it. Slowly push the rack towards the back wall until it is free of the rack stop.
- 2 After disengaging the rack stop, lift the back of the rack and pull the rack and frame out between the rack guides.

### Convection Bake and Roast Mode

The convection system uses a fan to circulate the heat evenly within the oven. Improved heat distribution allows for even cooking and excellent results while cooking with single or multiple racks.

The oven can be programmed to bake at any temperature from 170 °F (80 °C) to 550 °F (285 °C). The default temperature is 350 °F (175 °C).

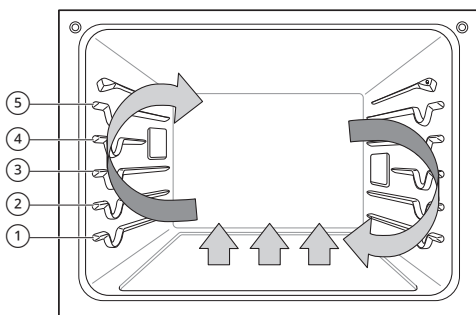

### Using Convection

- 1 Press **Conv.Bake** or **Conv.Roast**.

- 2 Press the numbers to enter the desired temperature.
- 3 If desired, press **Cook Time** to set the cook time or **Start Time** to set the delayed start time. Press the numbers to set the time settings.
- 4 Press **START**. The oven starts to preheat.
- 5 If the cook time is set, the remaining time appears in the display. If a delayed start time is set, the start time appears in the display.
- 6 A chime sounds once preheating is complete.
- 7 A chime sounds at the end of the set cook time and a notification appears in the display. Open the oven door and remove the food.

### NOTE

- If no cook time is set, the oven turns off automatically after 12 hours.
- The heating elements and fan turn off immediately when the door is opened. They turn on again approximately 1 second after the door is closed.
- Press **Stop** in the display to cancel Convection Bake and Convection Roast at any time.
- The oven fan runs while convection baking and convection roasting. The fan stops when the door is opened. In some cases, the fan may shut off during a convection bake cycle.

### Changing the Cook Settings

- 1 Press **Conv.Bake** or **Conv.Roast**.
- 2 Press the numbers to enter the desired temperature.
- 3 Press **START**.

### To Stop Cooking

- 1 Press **Lower CLEAR / OFF**.

### Tips for Convection Baking

- Use Convection Bake for faster and more even multiple-rack cooking of pastries, cookies, muffins, biscuits, and breads of all kinds.
- Bake cookies and biscuits on pans with no sides or very low sides to allow heated air to circulate around the food. Food baked on pans with a dark finish will cook faster.
- When using Convection Bake with a single rack, place oven rack in position ③. If cooking on multiple racks, place the oven racks in positions ② and ④.
- Multiple oven rack cooking may slightly increase cook times for some foods.
- Cakes, cookies and muffins have better results when using multiple racks.

The Convection Roast feature is designed to give optimum roasting performance. Convection Roast combines cooking with the convection fan to roast meats and poultry. The heated air circulates around the food from all sides, sealing in juices and flavors. Foods are crispy brown on the outside while staying moist on the inside. Convection roasting is especially good for large tender cuts of meat, uncovered.

### Tips for Convection Roasting

Use a \*broiler pan and \*grid when preparing meats for convection roasting. The broiler pan catches grease spills and the grid helps prevent grease splatters.

- 1 Place the oven rack in position ① or ②.
- 2 Place the grid ① in the broiler pan ②.

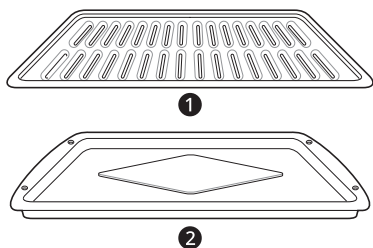

- 3 Place the broiler pan on the oven rack.

#### NOTE

- \* : Sold separately

#### CAUTION

- Do not use a broiler pan without a grid.

- Do not cover the grid with aluminum foil.
- Position food (fat side up) on the grid.

### Bake Mode

Bake is used to prepare foods such as pastries, breads and casseroles.

The oven can be programmed to bake at any temperature from 170 °F (80 °C) to 550 °F (285 °C). The default temperature is 350 °F (175 °C).

### Setting the Bake Function

- 1 Press **Bake**.
- 2 Press the numbers to enter the desired temperature.
- 3 If desired, press **Cook Time** to set the cook time or **Start Time** to set the delayed start time. Press the numbers to set the time settings.
- 4 Press **START**. The oven starts to preheat.
- 5 If the cook time is set, the remaining time appears in the display. If a delayed start time is set, the start time appears in the display.
- 6 A chime sounds once preheating is complete.
- 7 A chime sounds at the end of the set cook time and a notification appears in the display. Open the oven door and remove the food.

#### NOTE

- If no cook time is set, the oven turns off automatically after 12 hours.

### Changing the Cook Settings

- 1 Press **Bake**.
- 2 Press the numbers to enter the desired temperature.

### 3 Press **START**.

#### To Stop Cooking

Press **Lower CLEAR / OFF**.

#### NOTE

- It is normal for the convection fan to operate periodically throughout a normal bake cycle in the oven. This is to ensure even baking results.

#### Baking Tips

- For best results, food should be placed on a single rack with at least 1" to 1 1/2" of air space between the pans and oven walls.
- Baking time and temperature will vary depending on the characteristics, size, and shape of the baking pan used.
- Check for food doneness at the minimum recipe time.
- Use metal bakeware (with or without a nonstick finish), heatproof glass-ceramic, ceramic or other bakeware recommended for oven use.
- Dark metal pans or nonstick coatings will cook food faster with more browning. Insulated bakeware will slightly lengthen the cooking time for most foods.
- The oven bottom has a porcelain-enamel finish. To make cleaning easier, protect the oven bottom from excessive spills by placing a cookie sheet on the rack below the rack you are cooking on. This is particularly important when baking a fruit pie or other foods with a high acid content. Hot fruit fillings or other foods that are highly acidic may cause pitting and damage to the porcelain-enamel surface and should be wiped up immediately.

#### Recommended Baking Guide

##### Rack and Pan Placement

Baking results will be better if baking pans are centered in the oven as much as possible. If cooking on multiple racks, place the oven racks in the positions shown.

Multiple-rack cooking saves time and energy. Whenever possible, cook foods requiring the same cooking temperature together in one oven.

If baking with more than one pan, place the pans so that each one has at least 1" (25 mm) to 1 1/2" (38 mm) of air space around them.

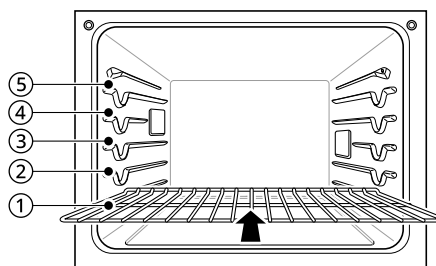

##### Multiple Rack Position

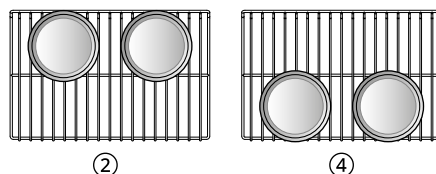

##### Single Rack Position

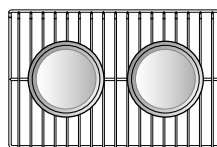

##### Baking Rack Guide

Type of Food	Rack Position
Angel food cake, frozen pies	③
Bundt or pound cakes	②
Biscuits, muffins, brownies, cookies, cupcakes, layer cakes, pies	③
Casseroles	②
Turkey, roasts, or ham	①
Frozen pizza	③
Roast chicken	②

#### NOTE

- When baking cakes and cookies on multiple racks, use the Convection Bake mode and place racks in positions ② and ④.

## Broil Mode

### Setting the Oven to Broil

Broiling uses an intense, radiant heat to cook food. Both the inner and outer broil elements heat during full broiling. Only the inner broil element heats during center broiling. The element(s) cycle on and off at intervals to maintain the oven temperature.

Keep the oven door closed while broiling. Let the oven preheat for approximately 5 minutes before cooking food.

#### CAUTION

- Do not use a broiler pan without a grid. Oil can cause a grease fire.
- Do not cover the grid and broiler pan with aluminum foil. Doing so will cause a fire.
- Always use a broiler pan and grid for excess fat and grease drainage. This will help to reduce splatter, smoke, and flare-ups.
- Should an oven fire occur, leave the oven door closed and turn the oven off. If the fire continues, throw baking soda on the fire or use a fire extinguisher.
- DO NOT put water or flour on the fire. Flour may be explosive and water can cause a grease fire to spread and cause personal injury.
- When using your broiler, the temperature inside the oven will be extremely high. Take care to avoid possible burns by:
  - Keeping the door closed when broiling
  - Always wearing oven mitts when inserting or removing food items

#### NOTE

- This appliance is designed for closed-door broiling. Close the door to set the Broil function. If the door is open, the Broil function cannot be set and **DOOR OPEN** appears on the display. Close the door and reset the Broil function. If the door is opened during broiling, the broil burner turns off after five seconds. The broiler turns back on automatically once the door is closed.

- 1** Place the food on the grid in the broiler pan.
- 2** Press **Broil**.
- 3** Press **1** for Full broil, **2** for Center broil.

- 4** Press **1** for High, **2** for Medium, or **3** for Low temperature setting.
- 5** If desired, press **Cook Time** to set the cook time. Press the numbers to set the time settings.
- 6** Press **START**.
- 7** Let the oven preheat for approximately 5 minutes before cooking the food.
- 8** If the cook time is set, the remaining time appears in the display.
- 9** Press **Lower CLEAR / OFF** to cancel at any time or when cooking is complete.

#### NOTE

- If the cook time is not set, the oven automatically turns off after 3 hours.
- The heating element(s) turn off after 5 seconds when the door is opened. They turn on again approximately 1 second after the door is closed.

### Changing the Broil Settings

- 1** Press **Broil**.
- 2** Press the numbers to enter the desired temperature.
- 3** Press **START**.

### To Stop Broiling

Press **Lower CLEAR / OFF**.

### Tips for Reducing Smoke

Due to the intense heat associated with broiling, it is normal to experience smoke during the cooking process. This smoke is a natural byproduct of searing and should not cause you to worry. If you are experiencing more smoke than you are comfortable with, use the following tips to reduce the amount of smoke in your oven.

## 40 OPERATION

- Always use a broiler pan. Do not use saute pans or regular baking sheets for safety reasons.
- The broiler pan should always be thoroughly cleaned and at room temperature at the beginning of cooking.
- Always run your cooktop ventilation system or vent hood during broiling.
- Keep the interior of your oven as clean as possible. Leftover debris from prior meals can burn or catch fire.
- Avoid fatty marinades and sugary glazes. Both of these will increase the amount of smoke you experience. If you would like to use a glaze, apply it at the very end of cooking.
- If you are experiencing significant smoke with any food item, consider:
  - Lowering the broiler to the **LO** setting.
  - Lowering the rack position to cook the food farther away from the broiler.
  - Using the **HI** broil setting to achieve the level of searing you desire, and then either switching to the **LO** broil setting, or switching to the Bake function.
- As a rule, fattier cuts of meat and fish will produce more smoke than leaner items.
- Adhere to the guidelines in the **Recommended Broiling Guide** section whenever possible.

## Recommended Broiling Guide

### Recommended Broiling Guide

The size, weight, thickness, starting temperature, and your preference of doneness will affect broiling times.

This guide is based on meats at refrigerator temperature. For best results when broiling, use a pan designed for broiling.

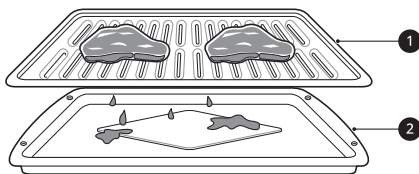

① Grid (sold separately)

② Broiler Pan (sold separately)

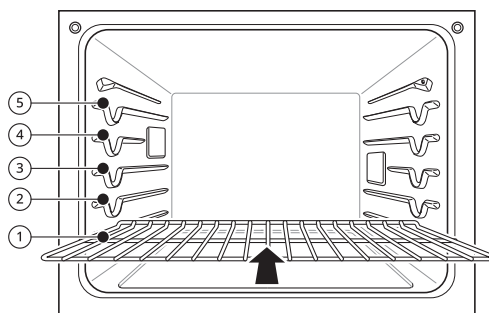

Food	Quantity and/or Thickness	Rack Position	First Side Time (min.)	Second Side Time (min.)	Comments
<b>Ground Beef</b>	1 lb (9 patties) 1/2 to 3/4" thick	⑤	4-6	3-4	Space evenly. Up to 9 patties may be broiled at once.

Food	Quantity and/or Thickness		Rack Position	First Side Time (min.)	Second Side Time (min.)	Comments
<b>Beef Steaks</b>	1" thick 1 to 1½ lbs.	Rare	④	6	2-3	Steaks less than 1" thick cook through before browning. Pan frying is recommended. Slash fat.
		Medium	④	7	2-3	
		Well done	④	8	3-4	
	1½" thick 2 to 2½ lbs	Rare	④	10	4-6	
		Medium	④	12	6-8	
		Well done	④	14	8-10	
<b>Chicken</b>	1 whole, 2 to 2½ lbs., split lengthwise		③	20	6-8	Broil skin-side-down first.
	2 Breasts		③	20	6-10	
<b>Lobster Tails</b>	2-4 10 to 12 oz each		③	12-14	Do not turn over.	Cut through back of shell. Spread open. Brush with melted butter before broiling and after half of broiling time.
<b>Fish Fillets</b>	¼ to ½" thick		④ or ⑤	5-6	3-4	Handle and turn very carefully. Brush with lemon butter before and during cooking, if desired.
<b>Ham Slices (precooked)</b>	½" thick		④	5	3-5	Increase time 5 to 10 minutes per side for 1½" thick or home-cured ham.
<b>Pork Chops</b> Well done	2 (½" thick)		④ or ⑤	7	6-8	Slash fat.
	2 (1" thick) about 1lb.		④ or ⑤	9-10	7-9	
<b>Lamb Chops</b>	2 (1" thick) about 10 to 12 oz	Medium	④	6	4-6	Slash fat.
		Well done	④	8	7-9	
	2 (1½" thick) about 1lb	Medium	④	11	9	
		Well done	④	13	9-11	
<b>Salmon Steaks</b>	2 (1" thick)		④ or ⑤	8	3-4	Grease pan. Brush steaks with melted butter.
	4 (1" thick) about 1 lb		④ or ⑤	9	4-6	

- This guide is only for reference. Adjust cook time according to your preference.

## NOTE

- The USDA advises that consuming raw or undercooked fish, meat, or poultry can increase your risk of food-borne illness.

### NOTE

- The USDA has indicated the following as safe minimum internal temperatures for consumption:
    - Ground beef: 160 °F (71.1 °C)
    - Poultry: 165 °F (73.9 °C)
    - Beef, veal, pork, or lamb: 145 °F (62.8 °C)
    - Fish / Seafood: 145 °F (62.8 °C)
- 

## Tips for Broiling

### Beef

- Steaks and chops should always be allowed to rest for five minutes before being cut into and eaten. This allows the heat to distribute evenly through the food and creates a more tender and juicy result.
- Pieces of meat that are thicker than two inches should be removed from the refrigerator 30 minutes prior to cooking. This will help them cook more quickly and evenly, and will produce less smoke when broiling. Cooking times will likely be shorter than the times indicated in the Broiling Chart.
- For bone-in steaks or chops that have been frenched (all meat removed from around the bone), wrap the exposed sections of bone in foil to reduce burning.

### Seafood

- When broiling skin-on fish, always use the Lo broil setting and always broil the skin side last.
- Seafood is best consumed immediately after cooking. Allowing seafood to rest after cooking can cause the food to dry out.
- It is a good idea to rub a thin coating of oil on the surface of the broiling pan before cooking to reduce sticking, especially with fish and seafood. You can also use a light coating of non-stick pan spray.

### Vegetables

Toss your vegetables lightly in oil before cooking to improve browning.

## More Modes (Frozen Meal)

The Frozen Meal function is specially designed for cooking frozen prepared meals. It heats from both the top and bottom to brown food more evenly.

This system is designed to give the optimum cooking performance by automatically selecting a combination of the broil and bake heating systems. No preheating is required when using the Frozen Meal mode. For best results with frozen pizza, cook food on a single rack placed in position 4 at 400 °F.

## Setting the Frozen Meal Function

**1** Press **More Modes**.

**2** Press **1**.

**3** Press **START** or the numbers to enter the desired temperature from 300 °F to 550 °F.

**4** If desired, press **Cook Time** to set the cook time. Press the numbers to set the time settings.

**5** Press **START**

## Changing the Frozen Meal Settings

**1** Press **More Modes**.

**2** Press the numbers to enter the desired temperature.

**3** Press **START**

## Canceling the Frozen Meal Function

Press **Lower CLEAR / OFF**.

## More Modes (Warm)

This function will maintain an oven temperature of less than 200 °F (93 °C). It will keep cooked food warm for serving up to 3 hours after cooking has finished.

## Setting the Warm Mode

- 1** Press **More Modes**.
- 2** Press **2**.
- 3** Press **1** for High, **2** for Medium, or **3** for Low temperature setting.
  - High: 200 °F (93 °C)
  - Medium: 170 °F (77 °C)
  - Low: 140 °F (60 °C)
- 4** Press **START**. If the run time was set, the remaining time appears in the display.

## Canceling the Warm Function

Press **Lower CLEAR / OFF**.

### NOTE

- The Warm function is intended to keep food warm. Do not use it to cool food down.

## More Modes (Proof)

This feature maintains a warm oven for rising yeast-leavened products before baking.

## Setting the Proof Mode

- 1** Press **More Modes**.
- 2** Press **3**.
- 3** Press the numbers to set the time settings.

- 4** Press **START**. The remaining proofing time appears in the display.

### NOTE

- If the proofing time is not set, the oven automatically turns off after 12 hours.

## Canceling the Proof Function

Press **Lower CLEAR / OFF**.

### NOTE

- To avoid lowering the oven temperature and lengthening proofing time, do not open the oven door unnecessarily. Check bread products early to avoid over proofing.
- Do not use the Proofing mode for warming food or keeping food hot. The proofing oven temperature is not hot enough to keep foods at safe temperatures. Use the Warm feature to keep food warm. Proofing does not operate when the oven is above 125 °F. **OVEN IS HOT** shows in the display.
- It is normal for the fan to operate during the Proof function.
- The proof feature automatically provides the optimum temperature for the proofing process, and therefore does not have a temperature adjustment.
- For best results, cover the dough with a cloth or with plastic wrap. (The plastic may need to be anchored underneath the container so the oven fan does not blow it off.)

## More Modes (Favorite)

For frequently used cooking menus, you can combine up to three different temperatures and cooking modes into one hot key.

## Creating a Favorite

- When combining two or more cooking modes, a cooking time must be set before selecting an additional cooking mode.

- 1** Press **More Modes**.

- 2** Press **4**.

## 44 OPERATION

---

- 3** Press **More Modes** repeatedly to select the desired recipe.

Recipe	Default Temp. (°F) (may be changed and recalled)	Cooking Mode
1. Bread	375	<b>Bake</b>
2. Meat	325	<b>Conv.Roast</b>
3. Chicken	350	<b>Conv.Roast</b>

- 4** Press the numbers to enter the desired temperature.
- Only the selected temperature is stored, not the cooking time.
  - If the oven temperature is changed, the changed temperature is stored.
- 5** If desired, press **Cook Time** to set the cook time. Press the numbers to set the time settings.
- 6** Press **START**. Once the oven reaches the desired temperature, **PREHEATING** appears in the display.

---

### NOTE

- Proofing doesn't operate when the oven is above 125 °F (52 °C).
  - If using Proof after cooking, wait for the oven to cool first.
  - The Proof mode can only be set as a single stage, not as part of multi-stage cooking.
- 

## Air Fry

This feature automatically increases the entered temperature by 45 °F for optimal performance when using Air Fry.

The Air Fry mode on the Lower oven can be programmed to cook at any temperature from 300 °F (150 °C) to 500 °F (260 °C). The default temperature is 400 °F (205 °C).

The Air Fry function is specially designed for oil-free frying.

## Setting the Air Fry Mode

- 1** Press **Air Fry**.
- 2** Press the numbers to enter the desired temperature.
- 3** If desired, press **Cook Time** to set the cook time. Press the numbers to set the time settings.
- 4** Press **START**.
- 5** If the cook time is set, the remaining time appears in the display.

## Changing the Cook Settings

- 1** Press **Air Fry**.
- 2** Press the numbers to enter the desired temperature.
- 3** Press **START**.

## To Stop Cooking

Press **Lower CLEAR / OFF**.

---

### NOTE

- No preheating is required when using the Air Fry mode.
  - If cooking multiple batches, the later batches may take less time to cook.
  - Wet batters and coatings will not crisp or set when using the Air Fry mode.
-

## Tips for Air Fry

- For best results, use the provided air fry tray.
  - The mesh section of the air fry tray can be cleaned in a dishwasher.

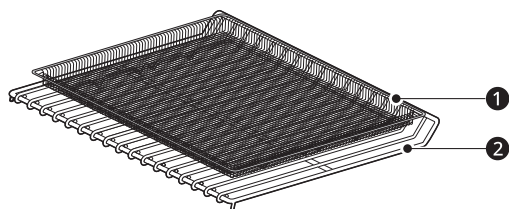

① Air Fry Tray

② Heavy Duty Rack

- If you don't have the air fry tray, place food on a wire rack inside a foil-lined broiler pan.

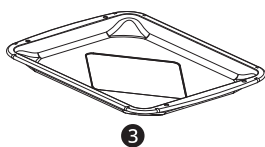

③ Broiler Pan

- For best results, cook food on a single rack placed in positions suggested in the chart in this manual.
- Spread the food out evenly in a single layer.
- Use either the air fry tray or a dark baking tray with no sides or short sides that does not cover the entire rack. This allows for better air circulation.
- If desired, spray the baking tray or air fry tray with a pan spray. Use an oil that can be heated to a high temperature before smoking, such as avocado, grapeseed, peanut or sunflower oil.
- Place a foil-lined baking tray on a rack in position 1 to catch the oil falling from the food. For high-fat foods like chicken wings, add a few sheets of parchment paper to absorb the fat.
- Check food often and shake it or turn it over for crisper results.
- Prepared frozen foods may cook faster with the Air Fry mode than stated on the package. Reduce the cooking time by about 20 percent, check food early, and adjust cooking time as needed.

## Recommended Air Frying Guide

- Arrange food evenly in a single layer.
- Put a foil-lined baking pan on a rack in position ② to catch drips. If needed, add parchment paper to absorb oil and reduce smoking.

- Use a food thermometer to make sure food has reached a safe temperature for consumption. Eating undercooked meats can increase your risk of food-borne illness.
- For the crispiest results, dredge fresh chicken wings or tenders in seasoned flour. Use 1/3 cup flour for 2 pounds of chicken.

## Recommendations When Air Frying High-Fat Foods

Foods high in fat will smoke when using the Air Fry mode. For best results, follow these recommendations when air frying foods that are high in fat, such as chicken wings, bacon, sausage, hot dogs, turkey legs, lamb chops, ribs, pork loin, duck breasts, or some plant-based proteins.

### ⚠ CAUTION

- Never cover slots, holes, or passages in the oven bottom or cover entire racks with materials such as aluminum foil. Doing so blocks airflow through the oven and can result in carbon monoxide poisoning. Aluminum foil can also trap heat, causing a fire hazard or poor oven performance.
- Turn on your exhaust hood at a high fan setting before you start Air Fry and leave it on for 15 minutes after you're done.
- Open a window or sliding glass door, if possible, to make sure the kitchen is well-ventilated.
- Clean the grease filters on your exhaust hood regularly.
- Keep the oven free from grease buildup. Wipe down the interior of the oven before and after air frying (once the oven has cooled).
- Run oven cleaning cycles (**EasyClean** or **SelfClean**) regularly, depending on how often and what types of food you **Air Fry**.
- Avoid opening the oven door more than necessary to help maintain the oven temperature, prevent heat loss, and save energy.
- Air-frying fresh chicken pieces such as wings or drumsticks with the skin left on can produce smoke as the fat renders at high temperatures. If the smoke is excessive, use the Convection Roast mode instead of Air Fry.

## 46 OPERATION

- Flip food over during cooking to avoid burning it.

† High-fat items may produce more smoke when cooked using Air Fry. For less smoke, cook using Convection Roast mode.

Recommended Items	Quantity (oz)	Temp. (°F)	Rack Position	Time	Guide
<b>POTATOES-Frozen</b>					
Frozen French Fries (Shoestring)	20	425	③	15-25	-
Frozen French Fries (Crinkle cut, 10x10 mm)	35	400	③	18-28	-
Frozen Sweet Potato Fries	25	400	③	15-25	-
Frozen Tater Tots	50	425	③	18-28	-
Frozen Hash Browns	40	425	③	18-28	-
<b>POTATOES-Fresh/Homemade</b>					
Homemade French Fries (10x10 mm)	25	425	③	20-30	Cut the potatoes and soak for 30 minutes in hot tap water. Drain and pat dry. Brush or lightly spray with 3 tbsp. of oil. Add salt and pepper to taste.
Homemade Potato Wedges	60	425	③	30-40	
<b>CHICKEN-Frozen</b>					
Frozen Chicken Nuggets, Crispy	30	400	③	15-25	-
Frozen Chicken Strips	35	400	③	25-35	-
Frozen Hot Wings, Bone-in	50	400	③	25-35	-
<b>CHICKEN-Fresh, Skin on</b>					
Fresh Chicken Wings <sup>†</sup>	40	450	③	25-35	Brush or lightly spray with 1 tbsp. of oil. Add salt and pepper to taste.
Fresh Chicken Drumsticks <sup>†</sup>	70	450	③	30-40	
Thighs	40	450	③	25-35	
Breasts	40	450	③	25-35	
<b>OTHER</b>					
Frozen Onion Rings, Breaded	20	400	③	15-25	-
Frozen Spring Rolls (0.7 oz each)	45	400	③	15-25	-
Thin Sausage (2.5 oz each, diameter 0.8")	90	400	③	15-25	-

Recommended Items	Quantity (oz)	Temp. (°F)	Rack Position	Time	Guide
Frozen Coconut Shrimp	25	400	③	15-25	Brush or lightly spray the surface of food with oil.
Fresh Scallops on the half shell (35.3 oz)	35	400	③	15-25	Melt 4 tbsp. of butter and brush on scallops. Mix 1/2 cup bread crumbs, 1 tbsp. minced garlic, 1/4 cup grated parmesan cheese and season to taste. Sprinkle mixture over scallops.
Fresh Shrimp	50	400	③	15-25	-
Mixed Vegetables	35	425	③	13-23	Brush or lightly spray with 4 tbsp. of olive oil. Add salt and pepper to taste.

## Remote Start Mode

If the appliance is connected to a home Wi-Fi network, the preheating function of the oven can be started or stopped using the **LG ThinQ** smartphone app.

### Preparing the Oven for a Remote Start

- 1 Open the oven door to make sure the oven is empty and ready for preheating. Do not place food in the oven. Close the oven door. Remote Start can only be set when the oven door is closed.
- 2 Press **Remote Start**.
- 3 When **Remote Start Ready** appears in the display, the Remote Start function is ready to use.
- 4 Follow the instructions in the **LG ThinQ** smartphone app for using the Remote Start function.

#### NOTE

- Remote Start is disconnected in the following situations:
  - Remote Start is never set up in the smartphone app.
  - The Remote Start status is "ready".

- Remote Start experiences a problem during operation.
- The Wi-Fi icon on the display shows the status of the appliance's network connection. If the Wi-Fi icon is not lit, use the smartphone app to select the Wi-Fi network or connect the product again.
- A faulty Wi-Fi connection could delay the Remote Start function.

## Sabbath Mode

Sabbath mode is typically used on the Jewish Sabbath and Holidays. While the oven is in Sabbath mode, the temperature cannot be changed and the timer, light, and alarm functions are disabled. When the Sabbath mode is activated, the oven does not turn off until the Sabbath mode is deactivated. In Sabbath mode, all function buttons are inactive. 5b will appear in the display.

- 1 Press **Bake**.
- 2 Press the numbers to enter the desired temperature.
- 3 Press **START**.
- 4 Press and hold **Settings** for 3 seconds. 5b appears in the display when the Sabbath mode is activated.



- 5** To stop the Sabbath mode, press and hold **Settings** for 3 seconds.

---

**NOTE**

- If a cook time is set, the oven turns off automatically at the end of the cook time, without chiming. The oven remains in Sabbath mode, but is turned off.
  - If no cook time is set, the oven will not automatically turn off.
  - After a power failure, the display will turn back on in Sabbath mode, but the oven will be off.
  - Always close the oven door before engaging Sabbath Mode.
-

# SMART FUNCTIONS

## LG ThinQ Application

This feature is only available on models with Wi-Fi.

The **LG ThinQ** application allows you to communicate with the appliance using a smartphone.

### LG ThinQ Application Features

#### • Product Upgrades

- On models with the **LG UP** Home Appliance feature, experience new features by upgrading the product through the **LG ThinQ** app.

#### • Monitoring

- This function helps you check the current status, remaining time, cook settings and end time in one place.

#### • Product Notifications

- Turn on the Push Alerts to receive appliance status notifications. The notifications are triggered even if the **LG ThinQ** application is not open.

#### • Timer

- You can set the timer from the application.

#### • Settings

- Allows you to set various options on the oven and in the application.

#### • Smart Diagnosis™

- This function provides useful information for diagnosing and solving issues with the appliance based on the pattern of use.

#### • Firmware Update

- Keep the appliance updated.

### NOTE

- In the following cases, you must update the network information for each appliance in the **LG ThinQ** application under **Device Cards** → **Settings** → **Change Network**.
  - wireless router is changed
  - wireless router password is changed
  - Internet service provider is changed
- This information is current at the time of publication. The application is subject to change for product improvement purposes without notice to users.

## Installing LG ThinQ Application and Connecting an LG Appliance

### Models with QR Code

Scan the QR code attached to the product using the camera or a QR code reader application on your smartphone.



### NOTE

- To verify the Wi-Fi connection, check that the  icon on the control panel is lit.
- The appliance supports 2.4 GHz Wi-Fi networks only. To check your network frequency, contact your Internet service provider or refer to your wireless router manual.
- **LG ThinQ** is not responsible for any network connection problems or any faults, malfunctions, or errors caused by network connection.
- The surrounding wireless environment can make the wireless network service run slowly.
- If the distance between the appliance and the wireless router is too far, the signal becomes weak. It may take a long time to connect or fail to install the application.
- If the appliance is having trouble connecting to the Wi-Fi network, it may be too far from the router. Purchase a Wi-Fi repeater (range extender) to improve the Wi-Fi signal strength.
- The network connection may not work properly depending on the Internet service provider.
- The Wi-Fi may not connect or the connection may be interrupted because of the home network environment.
- If the appliance cannot be connected due to problems with the wireless signal transmission, unplug the appliance and wait about a minute before trying again.
- If the firewall on your wireless router is enabled, disable the firewall or add an exception to it.
- The wireless network name (SSID) should be a combination of English letters and numbers. (Do not use special characters.)

**NOTE**

- Smartphone user interface (UI) may vary depending on the mobile operating system (OS) and the manufacturer.
- If the security protocol of the router is set to **WEP**, network setup may fail. Change the security protocol (**WPA2** is recommended), and connect the product again.
- To reconnect the appliance or add another user, press and hold the **Wi-Fi** button for 3 seconds. Run the **LG ThinQ** application and follow the instructions in the application to connect the appliance.

**Radio Equipment Specifications**

Type	Operating Frequency Range	Output Power (Max.)
Wireless LAN	2400 MHz - 2472 MHz	< 1 W
Bluetooth <sup>†</sup>	2400 MHz - 2483.5 MHz	

† This feature is only available on some models.

**Industry Canada Statement**

This device contains licence-exempt transmitter(s)/ receiver(s) that comply with Innovation, Science and Economic Development Canada's licence-exempt RSS(s). Operation is subject to the following two conditions:

- (1) This device may not cause interference.
- (2) This device must accept any interference, including interference that may cause undesired operation of the device.

**IC Radiation Exposure Statement**

This equipment complies with IC radiation exposure limits set forth for an uncontrolled environment.

This equipment should be installed and operated with a minimum distance of 20 cm (7.8 inches) between the antenna and your body.

**NOTE**

- THE MANUFACTURER IS NOT RESPONSIBLE FOR ANY RADIO OR TV INTERFERENCE CAUSED BY UNAUTHORIZED MODIFICATIONS TO THIS EQUIPMENT. SUCH MODIFICATIONS COULD

VOID THE USER'S AUTHORITY TO OPERATE THE EQUIPMENT.

**Open Source Software Notice Information**

To obtain the source code that is contained in this product, under GPL, LGPL, MPL, and other open source licenses that have the obligation to disclose source code, and to access all referred license terms, copyright notices and other relevant documents, please visit <https://opensource.lge.com>.

LG Electronics will also provide open source code to you on CD-ROM for a charge covering the cost of performing such distribution (such as the cost of media, shipping, and handling) upon email request to [opensource@lge.com](mailto:opensource@lge.com).

This offer is valid to anyone in receipt of this information for a period of three years after our last shipment of this product.

**Smart Diagnosis™ Feature**

Use this feature to help you diagnose and solve problems with your appliance.

**NOTE**

- For reasons not attributable to LGE's negligence, the service may not operate due to external factors such as, but not limited to, Wi-Fi unavailability, Wi-Fi disconnection, local app store policy, or app unavailability.
- The feature may be subject to change without prior notice and may have a different form depending on where you are located.

**Using LG ThinQ to Diagnose Issues**

If you experience a problem with your Wi-Fi equipped appliance, it can transmit troubleshooting data to a smartphone using the **LG ThinQ** application.

- Launch the **LG ThinQ** application and select the **Smart Diagnosis** feature in the menu. Follow the instructions provided in the **LG ThinQ** application.

## Using Audible Diagnosis to Diagnose Issues

Follow the instructions below to use the audible diagnosis method.

- Launch the **LG ThinQ** application and select the **Smart Diagnosis** feature in the menu. Follow the instructions for audible diagnosis provided in the **LG ThinQ** application.

- 1** Press the **START** button for 3 seconds.
  - If the display has been locked, you must deactivate the lock and then reactivate it.
- 2** Hold the mouthpiece of your phone in front of the control panel, as shown below.

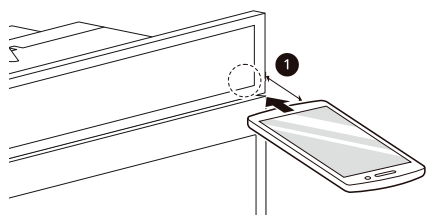

**1** Max: 3/8" (10 mm)

- 3** Keep the phone in place until the tone transmission has finished. The display will count down the time. Once the countdown is over and the tones have stopped, the diagnosis will be displayed in the application.

### NOTE

- For best results, do not move the phone while the tones are being transmitted.

# MAINTENANCE

## Cleaning

### General Cleaning Tips

- A plastic spatula can be used as a scraper to scrape off any chunks or debris before and during oven cleaning.
- Using the rough side of a non-scratch scouring pad may help to take off burnt-on stains better than a soft sponge or towel.
- Certain non-scratch scrubbing sponges, such as those made of melamine foam, available at your local stores, can also help improve cleaning.

### Cleaning the Interior of the Upper Oven

Wash often with warm, sudsy water and a sponge or soft cloth. Use only mild, nonabrasive soaps or a mild detergent. Keep the areas clean where the door and oven frame touch when closed.

Wipe well with a clean cloth. Over time, stains can occur on the surfaces as the result of food particles spattering during cooking. This is normal.

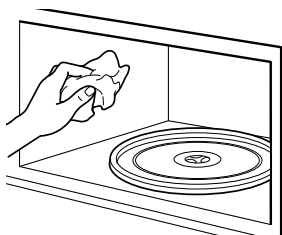

For stubborn soil, boil a cup of water in the oven for 2 to 3 minutes. Steam will soften the soil. To get rid of odors inside the oven, boil a cup of water with some lemon juice or vinegar in it.

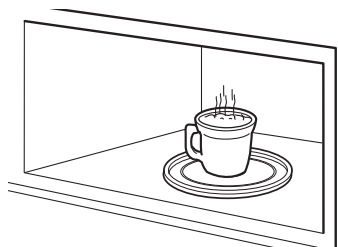

## Exterior

### Control Panel

To prevent activating the control panel during cleaning, disconnect power to the appliance. Clean up splatters with a damp cloth using a glass

cleaner. Remove heavier soil with warm, soapy water. Do not use abrasives of any kind.

### Painted and Decorative Trim

For general cleaning, use a cloth with hot soapy water. For more difficult soils and built-up grease, apply a liquid detergent directly onto the soil. Leave it on for 30 to 60 minutes. Rinse with a damp cloth and dry. Do not use abrasive cleaners.

### Stainless Steel Surfaces

To avoid scratches, do not use steel wool pads.

- 1 Place a small amount of stainless steel appliance cleaner or polish on a damp cloth or paper towel.
- 2 Clean a small area, rubbing with the grain of the stainless steel if applicable.
- 3 Dry and buff with a clean, dry paper towel or soft cloth.
- 4 Repeat as necessary.

### NOTE

- To clean the stainless steel surface, use warm sudsy water or a stainless steel cleaner or polish.
- Always wipe in the direction of the metal surface finish.
- Stainless steel appliance cleaner or polish can be purchased online or from most retailers of appliances or home goods.

### Oven Door

#### ⚠ CAUTION

- Do not use harsh cleaners or harsh abrasive cleaning materials on the outside of the oven door. Doing so can cause damage.
- Use soapy water to thoroughly clean the oven door. Rinse well. Do not immerse the door in water.
- You may use a glass cleaner on the outside glass of the oven door. Do not spray water or glass cleaner on the door vents.

- Do not use oven cleaners, cleaning powders, or harsh abrasive cleaning materials on the outside of the oven door.
- Do not clean the oven door gasket. The oven door gasket is made of a woven material that is essential for a good seal. Care should be taken not to rub, damage, or remove this gasket.

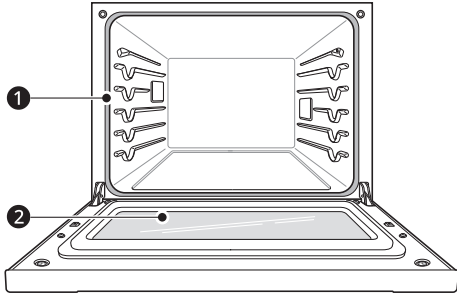

- 1 Don't hand clean oven door gasket
- 2 Do hand clean door

### Broiler Pan and Grid

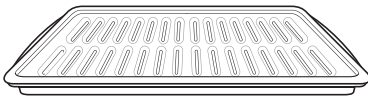

- Do not store a soiled broiler pan or grid anywhere in the appliance.
- Do not clean the broiler pan or grid in a self cleaning mode. (Available on some models)
- Remove the grid from the pan. Carefully pour out the grease from the pan into a proper container.
- Wash and rinse the broiler pan and grid in hot water with a soap-filled or plastic scouring pad.
- If food has burned on, sprinkle the grid with cleaner while hot and cover with wet paper towels or a dishcloth. Soaking the pan will remove burned-on foods.
- Both the broiler pan and grid may be cleaned with a commercial oven cleaner or in the dishwasher.

### Oven Racks

Remove the oven racks before operating the **Self Clean** cycle and **EasyClean**.

- 1 Clean with a mild, abrasive cleaner.
  - Food spilled into the tracks could cause the racks to become stuck.
- 2 Rinse with clean water and dry.

### NOTE

- If the racks are cleaned using the **Self Clean** cycle (not recommended), the color will turn slightly blue and the finish will become dull. After the **Self Clean** cycle is complete, and the oven has cooled, rub the sides of the racks with wax paper or a cloth containing a small amount of vegetable oil. This will make the racks glide more easily into the rack tracks.

### Oven Cavity

DO NOT use oven cleaners.

NEVER wipe a warm or hot porcelain surface with a damp sponge; it may cause chipping or crazing (tiny hairlike cracks). Food spills should be cleaned when the oven cools. At high temperature, foods react with porcelain and a permanent dull spot can result. When cleaning a spot, use only non-abrasive cleaners or scrubbers.

### Glass Tray and Rotating Ring

To clean the glass tray and rotating ring, wash in mild, sudsy water.

For heavily soiled areas use a mild cleanser and scouring sponge.

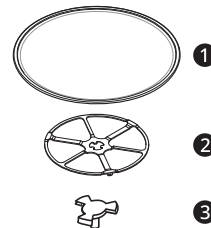

- 1 Glass tray
- 2 Rotating ring
- 3 Shaft

### NOTE

- The glass tray and rotating ring are dishwasher safe.

### EasyClean (Lower Oven)

LG's **EasyClean** enamel technology provides two cleaning options for the inside of the oven. The **EasyClean** feature takes advantage of LG's new enamel to help lift soils without harsh chemicals, and it runs using **ONLY WATER** for just 10 minutes in low temperatures to help loosen **LIGHT** soils before hand cleaning.

While **EasyClean** is quick and effective for small and **LIGHT** soils, the **Self Clean** feature can be used to remove **HEAVY**, built up soils. The intensity and high heat of the **Self Clean** cycle may result in smoke which will require the opening up of windows to provide ventilation. Compared to the more intense **Self Clean** process, your LG oven gives you the option of cleaning with **LESS HEAT**, **LESS TIME**, and virtually **NO SMOKE OR FUMES**. You can reduce energy use by cleaning light oven soils with the **EasyClean** feature instead of **Self Clean**.

When needed, the oven still provides the **Self Clean** option for longer, more thorough oven cleaning for heavier, built up soils.

- For hard to reach areas such as the back surface of the oven, it is better to use the **Self Clean** cycle.

### Benefits of EasyClean

- Helps loosen light soils before hand-cleaning
- **EasyClean** only uses water; no chemical cleaners
- Makes for a better **Self Clean** experience.
  - Delays the need for a **Self Clean** cycle
  - Minimizes smoke and odors
  - Can allow shorter **Self Clean** time

### When to Use EasyClean

- Example of oven soiling

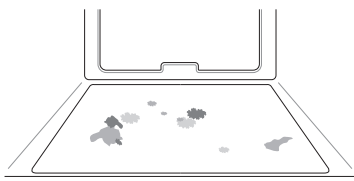

#### Case 1

- Soil pattern: Small drops or spots
- Types of soils: Cheese or other ingredients
- Common food items that can soil your oven: Pizza

#### Case 2

- Soil pattern: Light splatter
- Types of soils: Fat/grease
- Common food items that can soil your oven: Steaks, broiled / Fish, broiled / Meat roasted at low temperatures

## EasyClean Instruction Guide

### NOTE

- Allow the oven to cool to room temperature before using the **EasyClean** cycle. If your oven cavity is above 150 °F (65 °C), the **EasyClean** cycle will not be activated until the oven cavity cools down.
- The oven should be level to ensure that the bottom surface of the oven cavity is entirely covered by water at the beginning of the **EasyClean** cycle.
- For best results, use distilled or filtered water. Tap water may leave mineral deposits on the oven bottom.
- Soil baked on through several cooking cycles will be more difficult to remove with the **EasyClean** cycle.
- Do not open the oven door during the **EasyClean** cycle. Water will not get hot enough if the door is opened during the cycle.

- 1 Remove oven racks and accessories from the oven.
- 2 Scrape off and remove any burnt-on debris with a plastic scraper.

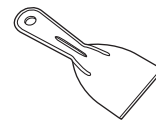

- Suggested plastic scrapers:
  - Hard plastic spatula
  - Plastic pan scraper
  - Plastic paint scraper
  - Old credit card

- 3 Fill a spray bottle (10 oz or 300 ml) with water and use the spray bottle to thoroughly spray the inside surfaces of the oven.

- 4 Use at least 1/5 (2 oz or 60 ml) of the water in the bottle to completely saturate the soil on both the walls and in the corners of the oven.

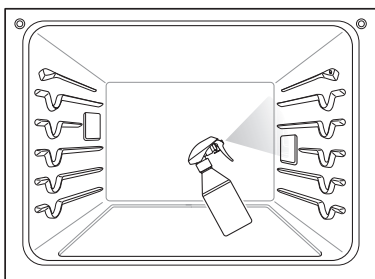

- 5 Spray or pour the remaining water (8 oz or 240 ml) onto the bottom center of the oven cavity. The indentation on the oven bottom should be fully covered to submerge all soils. Add water if necessary.

**NOTE**

- If cleaning multiple ovens, use an entire bottle of water to clean each oven. Do not spray water directly on the door. Doing so will result in water dripping to the floor.

- 6 Close the oven door. press **EasyClean** .

- 7 Press **START**.

**CAUTION**

- Some surfaces may be hot after the **EasyClean** cycle. Wear rubber gloves while cleaning to prevent burns.
- During the **EasyClean** cycle, the oven becomes hot enough to cause burns. Wait until the cycle is over before wiping the inside surface of the oven. Failure to do so may result in burns.
- Avoid leaning or resting on the oven door glass while cleaning the oven cavity.

- 8 A tone will sound at the end of the 10 minute cycle. Press **End of the Cleaning** in the display to end the EasyClean mode and the tone.

- 9 After the cleaning cycle and during hand-cleaning, enough water should remain on the oven bottom to completely submerge all soils. Add water if necessary. Place a towel on the floor in front of the oven to capture any water that may spill out during hand-cleaning.

- 10 Clean the oven cavity immediately after the **EasyClean** cycle by scrubbing with a wet, non-scratch scouring sponge or pad. (The scouring side will not scratch the finish.) Some water may spill into the bottom vents while cleaning, but it will be captured in a pan under the oven cavity and will not hurt the burner.

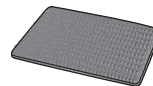

**NOTE**

- Do not use any steel scouring pads, abrasive pads or cleaners as these materials can permanently damage the oven surface.

- 11 Once the oven cavity is cleaned, wipe any excess water with a clean dry towel. Replace racks and any other accessories.

- 12 If some light soils remain, repeat the above steps, making sure to thoroughly soak the soiled areas.
  - If stubborn soils remain after multiple **EasyClean** cycles, run the **Self Clean** cycle. Be sure that the oven cavity is empty of oven racks and other accessories, and that the oven cavity surface is dry before running the **Self Clean** cycle. Consult the **Self Clean** section of your owner's manual for further details.

**NOTE**

- The cavity gasket may be wet when the **EasyClean** cycle finishes. This is normal. Do not clean the gasket.
- If mineral deposits remain on the oven bottom after cleaning, use a cloth or sponge soaked in vinegar to remove them.
- It is normal for the fan to operate during the **EasyClean** cycle.
- Using commercial oven cleaners or bleach to clean the oven is not recommended. Instead, use a mild liquid cleanser with a pH value below 12.7 to avoid discoloring the enamel.

**Self Clean (Lower Oven)**

The **Self Clean** cycle uses extremely hot temperatures to clean the oven cavity. While

running the **Self Clean** cycle, you may notice smoking or an odor. This is normal, especially if the oven is heavily soiled. During **Self Clean**, the kitchen should be well ventilated to minimize the odors from cleaning.

### Before Starting Self Clean

- Clean only parts listed in manual. Remove the oven racks, broiler pan, broiler grid, all cookware, aluminum foil or any other material from the oven.
  - If oven racks are left in the oven cavity during the **Self Clean** cycle, they will discolor and become difficult to slide in and out.
- The kitchen should be well ventilated to minimize the odors from cleaning. Open a window or turn on a ventilation fan or hood before self-cleaning.
- Wipe any heavy spillovers on the bottom of the oven.
- Make sure that the oven light cover is in place and the oven light is off.
- Clean the frame of the oven and door with hot soapy water. Rinse well.

### WARNING

- If the oven is heavily soiled with oil, self-clean the oven before using the oven again. The oil could cause a fire.
- If there is a fire in the oven during self-clean, turn the oven off and wait for the fire to go out. Do not force the door open. Introduction of fresh air at self-clean temperatures may lead to a burst of flame from the oven. Failure to follow this instruction may result in severe burns.

### CAUTION

- Do not use oven cleaners. Commercial oven cleaner or oven liner protective coating of any kind should not be used in or around any part of the oven.
- The oven displays an F error code and sounds three long beeps during the self-cleaning process if it malfunctions in the self-clean mode. Switch off the electrical power to the main fuse or breaker and have the oven serviced by a qualified technician.
- If the self cleaning mode malfunctions, turn the oven off and disconnect the power supply. Have it serviced by a qualified technician.
- It is normal for parts of the oven to become hot during a **Self Clean** cycle. Avoid touching the

door, window or oven vent area during a **Self Clean** cycle.

- Do not leave small children unattended near the appliance. During the **Self Clean** cycle, the outside of the oven can become very hot to the touch.
- If you have pet birds, move them to another well-ventilated room. The health of some birds is extremely sensitive to the fumes given off during the **Self Clean** cycle of any oven.
- Do not line the oven walls, racks, bottom or any other part of the oven with aluminum foil or any other material. Doing so will destroy heat distribution, produce poor baking results and cause permanent damage to the oven interior (aluminum foil will melt to the interior surface of the oven).
- Do not force the door open. This can damage the automatic door locking system. Use care when opening the oven door after the **Self Clean** cycle. Stand to the side of the oven when opening the door to allow hot air or steam to escape. The oven may still be VERY HOT.

### NOTE

- The oven light cannot be turned on during a **Self Clean** cycle. The oven light cannot be turned on until the oven temperature has cooled below 500 °F (260 °C) after a **Self Clean** cycle is complete.
- Clean the frame of the oven and door with hot soapy water. Rinse well.
- Do not clean the gasket. The fiberglass material of the oven door gasket cannot withstand abrasion. It is essential for the gasket to remain intact. If you notice it becoming worn or frayed, replace it.
- It is normal for the fan to operate during the **Self Clean** cycle.
- As the oven heats, you may hear sounds of metal parts expanding and contracting. This is normal and will not damage the oven.
- You may notice some white ash in the oven. Wipe it off with a damp cloth or a soap-filled steel wool pad after the oven cools. If the oven is not clean after one **Self Clean** cycle, repeat the cycle.
- If oven racks were left in the oven and do not slide smoothly after a **Self Clean** cycle, wipe racks and rack supports with a small amount of vegetable oil to make them glide more easily.
- After a **Self Clean** cycle, fine lines may appear in the porcelain because it went through heating

and cooling. This is normal and will not affect performance.

- The **Self Clean** cycle cannot be started if the **Lock Out** feature is active.
- Once the **Self Clean** cycle is set, the oven door locks automatically. You will not be able to open the oven door until the oven is cooled. The lock releases automatically.
- Once the door has been locked, the lock  indicator light stops flashing and remains on. Allow about 15 seconds for the oven door lock to activate.
- If the clock is set for a 12-hour display (default) the Delayed **Self Clean** can never be set to start more than 12 hours in advance.
- After the oven is turned off, the cooling fan keeps operating until the oven has cooled down.

### When to Use Self Clean

- Example of oven soiling



#### Case 1

- Soil pattern: Medium to heavy splatter
- Types of soils: Fat/grease
- Common food items that can soil your oven: Meat roasted at high temperatures

#### Case 2

- Soil pattern: Drops or spots
- Types of soils: Filling or sugar based soils
- Common food items that can soil your oven: Pies

#### Case 3

- Soil pattern: Drops or spots
- Types of soils: Cream or tomato sauce
- Common food items that can soil your oven: Casseroles

#### NOTE

- The **Self Clean** cycle can be used for soil that has been built up over time.

### Setting Self Clean

The **Self Clean** function has cycle times of 3, 4, or 5 hours.

#### Self Clean Soil Guide

Soil Level	Cycle Setting
Lightly Soiled Oven Cavity	3-Hour
Moderately Soiled Oven Cavity	4-Hour
Heavily Soiled Oven Cavity	5-Hour

- 1 Remove all racks and accessories from the oven.
- 2 Press **Self Clean**.  
The oven defaults to the recommended four-hour self clean for a moderately soiled oven.
- 3 Press **Self Clean** repeatedly to set the time settings.
- 4 If desired, press **Start Time** to set the delayed start time.  
Press the numbers to set the time settings.
- 5 Press **START**. The remaining time or the delayed start time appears in the display.

#### CAUTION

- Do not force the oven door open when the lock icon is displayed. The oven door remains locked until the oven temperature has cooled. Forcing the door open will damage the door.
- It may become necessary to cancel or interrupt a **Self Clean** cycle due to excessive smoke or fire in the oven. To cancel the Self Clean function, press **Stop** in the display.

### During Self Clean

- The **Self Clean** cycle uses extremely hot temperatures to clean the oven cavity. While running the **Self Clean** cycle, you may notice smoking or an odor. This is normal, especially if the oven is heavily soiled.
- As the oven heats, you may hear sounds of metal parts expanding and contracting. This is normal and will not damage the oven.

- Do not force the oven door open when the lock  is displayed. The oven door remains locked until the oven temperature has cooled. Forcing the door open will damage the door.

### After the Self Clean Cycle

- The oven door remains locked until the oven temperature has cooled.
- You may notice some white ash in the oven. Wipe it off with a damp cloth or a soap-filled pad after the oven cools. If the oven is not clean after one self-clean cycle, repeat the cycle.
- If oven racks were left in the oven and do not slide smoothly after a self-clean cycle, wipe racks and rack supports with a small amount of vegetable oil to make them glide more easily.
- Fine lines may appear in the porcelain because it went through heating and cooling. This is normal and will not affect performance.



## Periodic Maintenance

### Changing the Oven Light

The oven light is a standard 25-watt halogen bulb for ovens.

#### WARNING

- Make sure that the oven and bulb are cool.
- Disconnect the electrical power to the appliance at the main fuse or circuit breaker panel. Failure to do so can result in severe personal injury, death, or electrical shock.
- Wear gloves while changing the oven light. Glass fragments from broken bulbs can cause risk of injury.
- Gently twist the screwdriver blade while changing the oven light. If you apply force, the glass or oven may crack.

- 1 Unplug the oven or disconnect power.
- 2 Remove the oven racks.
- 3 Slide a flat blade screwdriver  between the housing and the glass light cover .

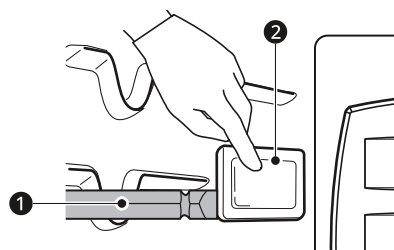

- 4 Support the glass light cover with two fingers to prevent the cover from falling to the bottom of the oven.
- 5 Gently twist the screwdriver blade to loosen the glass light cover .

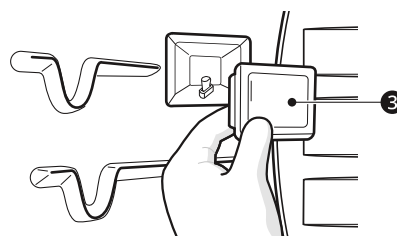

- 6 Remove the bulb from the socket.
- 7 Replace the bulb, and reassemble the light cover by snapping it back into place.
- 8 Plug in the oven or reconnect power.

# TROUBLESHOOTING

## FAQs

### Frequently Asked Questions

#### About the Upper Oven

**Q: Can I use a rack in my upper oven to reheat or cook on two levels at once?**

A: Only use the rack that is supplied with your upper oven. Use of any other rack can result in poor cooking performance and/or arcing and may damage your oven.

**Q: Will the upper oven be damaged if it operates while empty?**

A: Yes. Never operate the oven while it is empty or without the glass tray.

**Q: Does microwave energy pass through the viewing screen in the door?**

A: No. The metal screen bounces the energy back to the oven cavity. The holes (or ports) allow only light to pass through. They do not let microwave energy pass through.

**Q: Why do I see a light reflection around the outer case?**

A: This light is from the upper oven light which is located between the oven cavity and the outer wall of the oven.

**Q: What are the various sounds I hear when the upper oven is operating?**

A: The clicking sound is caused by a mechanical switch turning the microwave oven's magnetron ON and OFF.  
The heavy hum and clunk is from the change in power the magnetron draws as it is turned ON and OFF by a mechanical switch. The change in blower speed is from the change in line voltage caused by the magnetron being turned ON and OFF.

**Q: Can my upper oven be damaged if food is cooked for too long?**

A: Like any other cooking appliance, it is possible to overcook food to the point that the food creates smoke and even possibly fire, and damages the inside of the oven. It is always best to be near the oven while you are cooking.

**Q: Why is a standing time recommended after microwave cooking time is over?**

A: Standing time allows foods to continue cooking evenly for a few minutes after the actual microwave oven cooking cycle. The amount of standing time depends upon the density of the foods.

**Q: Why is additional time required for cooking food stored in the refrigerator?**

A: As in conventional cooking, the initial temperature of food affects total cooking time. You need more time to cook food taken out of a refrigerator than for food at room temperature.

**Q: Can I use either metal or aluminum pans in my upper oven?**

A: Usable metal includes aluminum foil for shielding (use small, flat pieces), and shallow foil trays (if tray is  $\frac{3}{4}$  inch deep and filled with food to absorb microwave energy). Never allow metal to touch walls or door.

**Q: Sometimes the door of my upper oven appears wavy. Is this normal?**

A: This appearance is normal and does not affect the operation of your oven.

**Q: Why does the glass tray not move?**

- A: The correct side of the tray should be facing up and the tray should sit firmly on the center hub. The support is not operating correctly. Reinstall the glass tray and restart the oven. Cooking without the glass tray can give you poor results.
- Q: Why does the dish become hot when I microwave food in it? I thought that this should not happen.**
- A: As the food becomes hot it will conduct the heat to the dish. Use hot pads to remove food after cooking.
- Q: What does standing time mean?**
- A: Standing time means that food should be taken out of the oven and covered for additional time after cooking. This process allows the cooking to finish, saves energy, and frees the oven for other purposes.
- Q: Can I pop popcorn in my upper oven? How do I get the best results?**
- A: Yes. Pop packaged microwave popcorn following manufacturer's guidelines or use the preprogrammed Popcorn button. Do not use regular paper bags. Use the listening test by stopping the oven as soon as the popping slows to a pop every one or two seconds. Do not try to repop unpopped kernels. You can also use special microwave poppers. When using a popper, be sure to follow manufacturer's directions. Do not pop popcorn in glass utensils.
- Q: Why does steam come out of the air exhaust vent?**
- A: Steam is normally produced during cooking. The upper oven has been designed to vent steam out of the top vent.

## About the Lower Oven

- Q: My new oven doesn't cook like my old one. Is there something wrong with the temperature settings?**
- A: No. Your oven has been factory tested and calibrated. For the first few uses, follow your recipe times and temperatures carefully. If you still think your new oven is too hot or too cold, you can adjust the oven temperature yourself to meet your specific cooking needs. Refer to the **Changing Settings** section in this manual for easy instructions on how to adjust your thermostat.
- Q: Is it normal to hear a clicking noise coming from the back of my oven when I am using it?**
- A: Your new appliance is designed to maintain a tighter control over your oven's temperature. You may hear your oven's heating elements click on and off more frequently on your new oven. This is NORMAL.
- Q: Why is the time flashing?**
- A: This means that the product has just been plugged in, or that it has experienced a power interruption. To clear the flashing time, touch any button and reset the clock if needed.
- Q: During convection cooking the fan stops when I open the door. Is that normal?**
- A: Yes, this is normal. When the door is opened, the convection fan will stop until the door is closed.
- Q: Can I use aluminum foil to catch drippings in my oven cavity?**
- A: Never use aluminum foil to line the bottom or sides of the oven. The foil will melt and stick to the bottom surface of the oven and will not be removable. Use a foil-lined sheet pan placed on a lower oven rack to catch drippings instead. (If foil has already melted onto the bottom of the oven, it will not interfere with the oven's performance.)
- Q: Can I use aluminum foil on the racks?**

- A: Do not cover racks with aluminum foil. Covering entire racks with foil restricts air flow, leading to poor cooking results. Use a sheet pan lined with foil under fruit pies or other acidic or sugary foods to prevent spillovers from damaging the oven finish.

### CAUTION

- Foil may be used to wrap food in the oven, but do not allow the foil to come into contact with the exposed heating/broiling elements in the oven. The foil could melt or ignite, causing smoke, fire, or injury.

#### **Q: Can I leave my racks in the oven when running a Self Clean cycle?**

A: No. Although it will not damage the racks, it will discolor them and may make them hard to slide in and out during use. Remove all items from the oven before starting a **Self Clean** cycle.

#### **Q: What should I do if my racks are sticky and have become hard to slide in and out?**

A: Over time, the racks may become hard to slide in and out. Apply a small amount of olive oil to the sides of the racks. This will work as a lubricant for easier gliding.

#### **Q: Why aren't the function buttons working?**

A: Make sure that the appliance is not in **Control Lock** mode. The lock  will show in the display if **Control Lock** is activated. To deactivate **Control Lock**, refer to the **Control Lock Feature** section. The unlock melody sounds and **Loc** appears in the display until the controls are unlocked.

#### **Q: My appliance is still dirty after running the EasyClean cycle. What else should I do?**

A: The **EasyClean** cycle only helps to loosen light soils in your appliance to assist in hand-cleaning of your oven. It does not automatically remove all soils after the cycle. Some scrubbing of your appliance is required after running the **EasyClean** cycle.

#### **Q: I tried scrubbing my oven after running EasyClean, but some soils still remain. What can I do?**

A: The **EasyClean** feature works best when the soils are fully soaked and submerged in water before running the cycle and during hand-cleaning. If soils are not sufficiently soaked in water, it can negatively affect the cleaning performance. Repeat the **EasyClean** process using sufficient water. Sugar-based and certain greasy soils are especially hard to clean. If some stubborn soils remain, use the **Self Clean** feature to thoroughly clean your oven.

#### **Q: Soils on my oven walls are not coming off. How can I get the oven walls clean?**

A: Soils on the side and rear walls of your appliance may be more difficult to fully soak with water. Try repeating the **EasyClean** process with more than the  $\frac{1}{4}$  cup (2 oz or 60 ml) of spray recommended.

#### **Q: Will EasyClean get all of the soils and stains out completely?**

A: It depends on the soil type. Sugar-based and certain grease stains are especially hard to clean. Also, if stains are not sufficiently soaked in water, this can negatively affect cleaning performance. If stubborn or built-up stains remain, use the **Self Clean** feature. Refer to the **Self Clean** section of your owner's manual.

#### **Q: Are there any tricks to getting some of the stubborn soils out?**

A: Scraping the soils with a plastic scraper before and during hand-cleaning is recommended. Fully saturating soils with water is also recommended. However, certain types of soils are harder to clean than others. For these stubborn soils, the **Self Clean** cycle is recommended. Consult the **Self Clean** section of your owner's manual for details.

#### **Q: Is it safe for my convection fan or heater element to get wet during EasyClean?**

A: Yes. The convection fan or heater element may get a little wet during cleaning. However, direct spray onto the broil burner and heater elements is not necessary because these are self-cleaning during regular use.

**Q: Do I need to use all 1 ¼ cups (10 oz or 300 ml) of water for EasyClean?**

A: Yes. It is highly recommended that 1 cup (8 oz or 240 ml) of water be sprayed or poured on the bottom and an additional ¼ cup (2 oz or 60 ml) of water be sprayed on walls and other soiled areas to fully saturate the soils for better cleaning performance.

**Q: I see smoke coming out of my appliance's vents during EasyClean. Is this normal?**

A: This is normal. This is not smoke. It is actually water vapor (steam) from the water in the oven cavity. As the oven heats briefly during **EasyClean**, the water in the cavity evaporates and escapes through the oven vents.

**Q: How often should I use EasyClean?**

A: **EasyClean** can be performed as often as you wish. **EasyClean** works best when your oven is LIGHTLY soiled from such things as LIGHT grease splatter and small drops of cheese. Please refer to the **EasyClean** section in your owner's manual for more information.

**Q: What is required for EasyClean?**

A: A spray bottle filled with 1¼ cups (10 oz or 300 ml) of water, a plastic scraper, a non-scratch scrubbing pad and a towel. You should not use abrasive scrubbers such as heavy-duty scouring pads or steel wool.

**Q: How can I help keep children safe around the appliance?**

A: Children should be supervised around the appliance whenever it is in use, and after use until surfaces have cooled. You can also use the **Control Lock** feature to help prevent children from accidentally turning on the oven. The **Control Lock** feature disables most control panel buttons. Consult the **Control Lock Feature** section of your owner's manual for details.

## Before Calling for Service

Review this section before calling for service; doing so will save you both time and money.

For detailed information or videos, visit [www.lg.com](http://www.lg.com) for the troubleshooting page.

### Cooking

Problem	Possible Cause & Solution
<b>Arcing or Sparking</b>	<b>Cookware is not microwave safe.</b> <ul style="list-style-type: none"> <li>When in doubt, test cookware before use.</li> </ul>
	<b>Do not operate oven while empty.</b> <ul style="list-style-type: none"> <li>Place the food in the oven.</li> </ul>
<b>Unevenly Cooked Foods, Overcooked Foods, Undercooked Foods, Improper Defrosting</b>	<b>Carefully monitor the food in the microwave oven while it is cooking.</b> <ul style="list-style-type: none"> <li>See the <b>Cooking Tips</b> in the <b>Operating the Upper Microwave Oven</b> section.</li> </ul>
<b>If the display shows a time counting down but the oven is not cooking.</b>	<b>The oven door is not closed.</b> <ul style="list-style-type: none"> <li>Check that the oven door is firmly closed.</li> </ul>
<b>Oven will not work</b>	<b>Plug on appliance is not completely inserted in the electrical outlet.</b> <ul style="list-style-type: none"> <li>Make sure electrical plug is plugged into a live, properly grounded outlet.</li> </ul>
	<b>A fuse in your home may be blown or the circuit breaker tripped.</b> <ul style="list-style-type: none"> <li>Replace the fuse or reset the circuit breaker.</li> </ul>
	<b>Oven controls improperly set.</b> <ul style="list-style-type: none"> <li>See the <b>OPERATION</b> chapter.</li> </ul>
	<b>Oven too hot.</b> <ul style="list-style-type: none"> <li>Allow the oven to cool to below locking temperature.</li> </ul>
<b>Steam is exhausted through the oven vent.</b>	<b>Cooking foods with high moisture produces steam.</b> <ul style="list-style-type: none"> <li>This is normal.</li> </ul>
<b>Appliance does not operate.</b>	<b>Cord is not plugged in correctly.</b> <ul style="list-style-type: none"> <li>Make sure cord is plugged correctly into outlet. Check circuit breakers.</li> </ul>
	<b>Service wiring is not complete.</b> <ul style="list-style-type: none"> <li>Contact your electrician for assistance.</li> </ul>
	<b>Power outage.</b> <ul style="list-style-type: none"> <li>Check house lights to be sure. Call your local electric company for service.</li> </ul>
<b>Oven smokes excessively during broiling.</b>	<b>Control not set properly.</b> <ul style="list-style-type: none"> <li>Follow instructions under <b>Changing Settings</b>.</li> </ul>
	<b>Meat too close to the element.</b> <ul style="list-style-type: none"> <li>Reposition the rack to provide proper clearance between the meat and the element. Preheat broil element for searing.</li> </ul>
	<b>Meat not properly prepared.</b> <ul style="list-style-type: none"> <li>Remove excess fat from meat. Cut remaining fatty edges to prevent curling.</li> </ul>
	<b>Insert on broiler pan wrong side up and grease not draining.</b> <ul style="list-style-type: none"> <li>Always place the grid on the broiler pan with ribs up and slots down to allow grease to drip into the pan.</li> </ul>

Problem	Possible Cause & Solution
<b>Oven smokes excessively during broiling.</b>	<p><b>Grease has built up on oven surfaces. Old grease or food spatters cause excessive smoking.</b></p> <ul style="list-style-type: none"> <li>• Regular cleaning is necessary when broiling frequently.</li> </ul>
<b>Food does not bake or roast properly</b>	<p><b>Oven controls improperly set.</b></p> <ul style="list-style-type: none"> <li>• See the <b>OPERATION</b> chapter.</li> </ul>
	<p><b>Rack position is incorrect or the rack is not level.</b></p> <ul style="list-style-type: none"> <li>• See the <b>OPERATION</b> chapter.</li> </ul>
	<p><b>Incorrect cookware or cookware of improper size being used.</b></p> <ul style="list-style-type: none"> <li>• See the <b>OPERATION</b> chapter.</li> </ul>
	<p><b>Aluminum foil used on the broiling pan and grid has not been fitted properly and slit as recommended.</b></p> <ul style="list-style-type: none"> <li>• See the <b>OPERATION</b> chapter.</li> </ul>
	<p><b>In some areas the power voltage may be low.</b></p> <ul style="list-style-type: none"> <li>• Preheat the broil element for 5-7 minutes.</li> <li>• See the <b>OPERATION</b> chapter.</li> </ul>
	<p><b>Oven sensor needs to be adjusted.</b></p> <ul style="list-style-type: none"> <li>• See the <b>OPERATION</b> chapter.</li> </ul>
<b>Food does not broil properly</b>	<p><b>Oven controls improperly set.</b></p> <ul style="list-style-type: none"> <li>• Make sure you select the <b>Broil</b> mode properly.</li> </ul>
	<p><b>Improper rack position being used.</b></p> <ul style="list-style-type: none"> <li>• See the Broiling Guide.</li> </ul>
	<p><b>Cookware not suited for broiling.</b></p> <ul style="list-style-type: none"> <li>• Use broiling pan and grid.</li> </ul>
	<p><b>Aluminum foil used on the broiling pan and grid has not been fitted properly and slit as recommended.</b></p> <ul style="list-style-type: none"> <li>• See the <b>OPERATION</b> chapter.</li> </ul>
	<p><b>In some areas the power voltage may be low.</b></p> <ul style="list-style-type: none"> <li>• Preheat the broil element for 5-7 minutes. See the Broiling Guide.</li> </ul>
<b>Oven temperature too hot or too cold</b>	<p><b>Oven sensor needs to be adjusted.</b></p> <ul style="list-style-type: none"> <li>• See the <b>OPERATION</b> chapter.</li> </ul>
<b>Excessive smoking during a Self Clean cycle (On some models)</b>	<p><b>Excessive soil.</b></p> <ul style="list-style-type: none"> <li>• Turn off the <b>Self Clean</b> function. Open the windows to rid the room of smoke. Wait until the <b>Self Clean</b> mode is cancelled. Wipe up the excess soil and reset the clean.</li> </ul>
<b>Burning or oily odor emitting from the vent</b>	<p><b>This is normal in a new oven.</b></p> <ul style="list-style-type: none"> <li>• This will disappear in time. To speed the process, set a <b>Self Clean</b> cycle for a minimum of 3 hours. See the <b>Self Clean</b> section.</li> </ul>
<b>Moisture collects on oven window or steam comes from oven vent</b>	<p><b>This happens when cooking foods high in moisture.</b></p> <ul style="list-style-type: none"> <li>• This is normal.</li> </ul>
	<p><b>Excessive moisture was used when cleaning the window.</b></p> <ul style="list-style-type: none"> <li>• Do not use excessive moisture when cleaning the window.</li> </ul>
<b>Oven will not steam cook (On some models)</b>	<p><b>Improper assembly</b></p> <ul style="list-style-type: none"> <li>• Make sure to slide the tank into the slot until it clicks into place.</li> </ul>

Problem	Possible Cause & Solution
Oven will not steam cook (On some models)	<p><b>The drain in the steam feeder tank may be clogged with hard water scale.</b></p> <ul style="list-style-type: none"> <li>If this happens, the descaling function must be run before the steam function can be used.</li> </ul>
Water pools in the bottom of the oven during or after steam cooking (On some models)	<p><b>During steam cooking, the water in the steam feeder tank is transferred to the bottom of the oven.</b></p> <ul style="list-style-type: none"> <li>It is normal for water to fill the bottom of the oven during or after the Steam mode.</li> <li>If the water leaves mineral deposits on the oven bottom, remove the deposits with a cloth or sponge soaked in vinegar.</li> </ul>
White residue appears on the oven bottom after steam cooking (On some models)	<p><b>Using hard water in the steam feeder tank can result in hard water scale on the oven bottom.</b></p> <ul style="list-style-type: none"> <li>To remove mineral deposits that remain on the oven bottom, use a cloth or sponge soaked in vinegar or a weak citric acid solution.</li> </ul>
The sous vide module beeps during operation (On some models)	<p><b>This alert sounds when the sous vide module is operated without water in the steam feeder tank.</b></p> <ul style="list-style-type: none"> <li>Fill the steam feeder tank to the recommended level before using</li> </ul>

## Parts & Features

Problem	Possible Cause & Solution
Oven control beeps and displays any F code error.	<p><b>Electronic control has detected a fault condition.</b></p> <ul style="list-style-type: none"> <li>Turn off the oven function you are using to clear the display and stop beeping. Reprogram oven. If fault recurs, record fault number and call for service. <ul style="list-style-type: none"> <li>[Case 1 ] Code: F-9 Cause: Oven not heating (upper oven)</li> <li>[Case 2 ] Code: F-19 Cause: Oven not heating (lower oven)</li> </ul> </li> </ul>
🔒 is on in the display when you want to cook	<p><b>The oven door is locked because the temperature inside the oven has not dropped below the locking temperature.</b></p> <ul style="list-style-type: none"> <li>Press the STOP button. Allow the oven to cool.</li> </ul>
Oven light does not work.	<p><b>It is time to replace the bulb or the bulb is loose.</b></p> <ul style="list-style-type: none"> <li>Replace or tighten bulb. See "Changing the Oven Light" section in this Owner's Manual.</li> </ul>
Cooling fan continues to run after oven is turned off.	<p><b>The fan turns off automatically when the electronic components have cooled sufficiently.</b></p> <ul style="list-style-type: none"> <li>This is normal.</li> </ul>
Oven will not Self Clean.	<p><b>The oven temperature is too high to set a Self Clean operation.</b></p> <ul style="list-style-type: none"> <li>Allow the appliance to cool and reset the controls.</li> </ul>
	<p><b>Oven controls improperly set.</b></p> <ul style="list-style-type: none"> <li>See the Self Clean section.</li> </ul>
	<p><b>A Self Clean cycle cannot be started if oven door is open.</b></p> <ul style="list-style-type: none"> <li>Close the oven door.</li> </ul>
Oven door does not open after a Self Clean cycle	<p><b>Oven is too hot.</b></p> <ul style="list-style-type: none"> <li>Allow the oven to cool below locking temperature.</li> </ul>

Problem	Possible Cause & Solution
Oven door does not open after a Self Clean cycle	<p><b>The control and door may be locked.</b></p> <ul style="list-style-type: none"> <li>Allow about one hour for the oven to cool after the completion of a Self Clean cycle. The door can be opened when the lock  is no longer displayed.</li> </ul>
The oven is not clean after a Self Clean cycle	<p><b>Oven controls not properly set.</b></p> <ul style="list-style-type: none"> <li>See the Self Clean section.</li> </ul>
	<p><b>Oven was heavily soiled.</b></p> <ul style="list-style-type: none"> <li>Clean up heavy spillovers before starting the clean cycle. Heavily soiled ovens may need to Self Clean again or for a longer period of time.</li> </ul>
Convection fan stops (On some models)	<p><b>Convection fan stops during a convection bake cycle. This allows for more even heating during the cycle.</b></p> <ul style="list-style-type: none"> <li>This is not a failure of the range and should be considered normal operation.</li> </ul>
Displayed time is flashing (On some models)	<p><b>This means that the product has just been plugged in, or that it has experienced a power interruption.</b></p> <ul style="list-style-type: none"> <li>Press the <b>Clock</b> key and reset the time, or press any key to stop the flashing.</li> </ul>
Oven racks are difficult to slide (On some models)	<p><b>The shiny, silver-colored racks were cleaned in a Self Clean cycle.</b></p> <ul style="list-style-type: none"> <li>Apply a small amount of vegetable oil to a paper towel and wipe the edges of the oven racks with the paper towel.</li> </ul>

## Noises

Problem	Possible Cause & Solution
“Crackling” or “popping” sound	<p><b>This is the sound of the metal heating and cooling during both the cooking and Self Clean functions.</b></p> <ul style="list-style-type: none"> <li>This is normal.</li> </ul>
Fan noise	<p><b>A convection fan may automatically turn on and off.</b></p> <ul style="list-style-type: none"> <li>This is normal.</li> </ul>

## Wi-Fi

Problem	Possible Cause & Solution
Trouble connecting appliance and smartphone to Wi-Fi network	<p><b>The password for the Wi-Fi network was entered incorrectly.</b></p> <ul style="list-style-type: none"> <li>Delete your home Wi-Fi network and begin the connection process again.</li> </ul>
	<p><b>Mobile data for your smartphone is turned on.</b></p> <ul style="list-style-type: none"> <li>Turn off the Mobile data on your smartphone before connecting the appliance.</li> </ul>
	<p><b>The wireless network name (SSID) is set incorrectly.</b></p> <ul style="list-style-type: none"> <li>The wireless network name (SSID) should be a combination of English letters and numbers. (Do not use special characters.)</li> </ul>
	<p><b>The router frequency is not 2.4 GHz.</b></p> <ul style="list-style-type: none"> <li>Only a 2.4 GHz router frequency is supported. Set the wireless router to 2.4 GHz and connect the appliance to the wireless router. To check the router frequency, check with your Internet service provider or the router manufacturer.</li> </ul>

Problem	Possible Cause & Solution
<b>Trouble connecting appliance and smartphone to Wi-Fi network</b>	<p><b>The appliance and the router are too far apart.</b></p> <ul style="list-style-type: none"> <li>• If the appliance is too far from the router, the signal may be weak and the connection may not be configured correctly. Move the router closer to the appliance or purchase and install a Wi-Fi repeater.</li> </ul>
	<p><b>During Wi-Fi setup, the app is requesting a password to connect to the product (on certain phones).</b></p> <ul style="list-style-type: none"> <li>• Locate the network name which starts with "LG" under Settings &gt; Networks. Note the last part of the network name. <ul style="list-style-type: none"> <li>- If the network name looks like LGE_Appliance_XX-XX-XX, enter lge12345.</li> <li>- If the network name looks like LGE_Appliance_XXXX, enter XXXX twice as your password. For example, if the network name appears as LGE_Appliance_8b92, then you would enter 8b928b92 as your password. In this instance, the password is case sensitive and the last 4 characters are unique to your appliance.</li> </ul> </li> </ul>

# LIMITED WARRANTY

## CANADA

### TERMS AND CONDITIONS

**ARBITRATION NOTICE: THIS LIMITED WARRANTY CONTAINS AN ARBITRATION PROVISION THAT REQUIRES YOU AND LG TO RESOLVE DISPUTES BY BINDING ARBITRATION INSTEAD OF IN COURT, UNLESS THE LAWS OF YOUR PROVINCE OR TERRITORY DO NOT PERMIT THAT, OR, IN OTHER JURISDICTIONS, IF YOU CHOOSE TO OPT OUT. FOR FURTHER CLARITY, THIS ARBITRATION PROVISION IS NOT APPLICABLE TO CONSUMERS RESIDING IN ONTARIO, BRITISH COLUMBIA OR QUÉBEC. IN ARBITRATION, CLASS ACTIONS AND JURY TRIALS ARE NOT PERMITTED. PLEASE SEE THE SECTION TITLED “PROCEDURE FOR RESOLVING DISPUTES” BELOW.**

QUEBEC ONLY: LG stands behind its products and makes every reasonable effort to ensure its products can be maintained and repaired, as required. You may access the catalogue of available parts and services at [https://www.lg.com/ca\\_en/support/](https://www.lg.com/ca_en/support/). HOWEVER, LG IN NO WAY GUARANTEES AND MAKES NO REPRESENTATIONS REGARDING THE AVAILABILITY OF ANY SPECIFIC SPARE OR REPLACEMENT PART, REPAIR SERVICE OR INFORMATION OR INSTRUCTIONS FOR SUCH MAINTENANCE AT ANY TIME. LG EXPRESSLY DISCLAIMS ANY GUARANTEE, WARRANTY OR OBLIGATION IN RESPECT OF THAT AVAILABILITY.

Should your LG **Electric Oven** (“Product”) fail due to a defect in materials or workmanship under normal and proper use, during the warranty period set forth below, LG Electronics Canada, Inc. (“LGECI”) will, at its option, repair or replace the Product upon receipt of proof of the original retail purchase. This limited warranty is valid only to the original retail purchaser of the Product and applies only to a Product distributed, purchased and used within Canada, as determined at the sole discretion of LGECI.

Warranty Period	Scope of Warranty	HOW SERVICE IS HANDLED
One (1) year from the date of original retail purchase	Parts and Labor (internal / functional parts only)	LG will provide, free of charge, all labor and in-home service to replace defective part(s).

- Replacement products and parts are warranted for the remaining portion of the original warranty period or ninety (90) days, whichever is greater.
- Replacement products and parts may be new, reconditioned, refurbished, or otherwise factory remanufactured, all at the sole discretion of LGECI.
- Proof of original retail purchase specifying the Product model and date of purchase is required to obtain warranty service under this Limited Warranty.

### DISCLAIMER:

IF YOU ARE A CONSUMER SUBJECT TO QUÉBEC, BRITISH COLUMBIA OR ONTARIO'S CONSUMER PROTECTION LEGISLATION, THE EXCLUSION OF WARRANTIES CONTAINED IN THIS SECTION DO NOT EXCLUDE OR LIMIT THE RIGHTS AND REMEDIES THAT YOU MAY HAVE UNDER SUCH ACT, INCLUDING THE RIGHT TO MAKE A CLAIM UNDER ANY OF THE STATUTORY WARRANTIES PROVIDED THEREUNDER.

**LGECI'S SOLE LIABILITY IS LIMITED TO THE LIMITED WARRANTY SET OUT ABOVE, UNLESS SUCH LIMITATION IS PROHIBITED BY THE LAWS OF THE PROVINCE IN WHICH YOU RESIDE. EXCEPT AS EXPRESSLY PROVIDED ABOVE, OR IF OTHERWISE PROHIBITED BY THE LAW OF THE PROVINCE IN WHICH YOU RESIDE, LGECI DOES NOT MAKE ANY OTHER WARRANTIES OR CONDITIONS RESPECTING THE PRODUCT, AND HEREBY DISCLAIMS, ALL OTHER WARRANTIES AND CONDITIONS RESPECTING THE PRODUCT, WHETHER EXPRESS OR IMPLIED, INCLUDING BUT NOT LIMITED TO, ANY IMPLIED WARRANTY OR CONDITION OF MERCHANTABILITY OR FITNESS FOR A PARTICULAR PURPOSE, AND NO REPRESENTATIONS SHALL BE BINDING ON LGECI. LGECI DOES NOT AUTHORIZE ANY PERSON TO CREATE OR ASSUME FOR IT ANY OTHER WARRANTY OBLIGATION OR LIABILITY IN CONNECTION WITH THE PRODUCT. TO THE EXTENT THAT ANY WARRANTY OR CONDITION IS IMPLIED BY LAW, IT IS LIMITED TO THE WARRANTY PERIOD SET OUT ABOVE. UNDER NO CIRCUMSTANCES SHALL LGECI, THE MANUFACTURER OR DISTRIBUTOR OF THE PRODUCT, BE LIABLE FOR ANY INCIDENTAL, CONSEQUENTIAL, SPECIAL, DIRECT, INDIRECT, PUNITIVE OR EXEMPLARY DAMAGES, INCLUDING,**

**WITHOUT LIMITATION, LOSS OF GOODWILL, LOST PROFITS, LOSS OF ANTICIPATED PROFITS, LOST REVENUE, LOSS OF USE, OR ANY OTHER DAMAGE, WHETHER ARISING DIRECTLY OR INDIRECTLY FROM ANY CONTRACTUAL BREACH, FUNDAMENTAL BREACH, TORT OR OTHERWISE, OR FROM ANY ACTS OR OMISSIONS. LGECI'S TOTAL LIABILITY, IF ANY, SHALL NOT EXCEED THE PURCHASE PRICE PAID BY YOU FOR THE PRODUCT.**

This Limited Warranty gives you specific legal rights. You may also have other rights that vary from province to province depending on applicable provincial laws. Any term of this Limited Warranty that negates or varies any implied condition or warranty under provincial law is severable where it conflicts with such provincial law without affecting the remainder of this warranty's terms.

## **THIS LIMITED WARRANTY DOES NOT COVER**

- Service trips to i) deliver, pick up, or install or; educate on how to operate the Product; ii) correct wiring or plumbing; or iii) correct unauthorized repairs or installations of the Product;
- Damage or failure of the Product to perform during power failures and interrupted or inadequate electrical service;
- Damage or failure resulting from operating the Product in a corrosive atmosphere or contrary to the instructions outlined in the Product's owner's manual;
- Damage or failure to the Product caused by accidents, pests and vermin, lightning, wind, fire, floods, acts of God, or any other causes beyond the control of LGECI or the manufacturer;
- Damage or failure resulting from misuse, abuse, improper installation, repair, or maintenance of the Product. Improper repair includes use of parts not authorized or specified by LGECI. Improper installation or maintenance includes installation or maintenance contrary to the Product's owner's manual;
- Damage or failure caused by unauthorized modification or alteration of the Product, or if used for other than the intended household purpose/use of the Product, or damage or failure resulting from any water leakage due to improper installation of the Product;
- Damage or failure caused by incorrect electrical current, voltage or plumbing codes;
- Damage or failure caused by use that is other than normal household use, including, without limitation, commercial or industrial use, including use in commercial offices or recreational facilities, or as otherwise outlined in the Product's owner's manual;
- Damage or failure caused by transportation and handling, including scratches, dents, chips and/or other damage to the finish of the Product, unless such damage results from defects in materials or workmanship and is reported to LGECI within one (1) week of delivery of the Products;
- Damage or missing items to any display, open box, refurbished or discounted Product;
- Refurbished Product or any Product sold "As Is", "Where Is", "With all Faults", or any similar disclaimer;
- Products with original serial numbers that have been removed, altered or cannot be readily determined at the discretion of LGECI;
- Increases in utility costs and additional utility expenses in any way associated with the Product;
- Any noises associated with normal operation of the Product;
- Replacement of light bulbs, filters, fuses or any other consumable parts;
- Replacement of any part that was not originally included with the Product;
- Costs associated with removal and/or reinstallation of the Product for repairs; and
- Shelves, drawers, handle and accessories to the Product, except for internal/functional parts covered under this Limited Warranty.
- Coverage for "in Home" repairs, for products in-warranty, will be provided if the Product is within a 150 km radius from the nearest authorized service center (ASC), as determined by LG Canada. If your Product is located outside a 150 km radius from a ASC, as determined by LG Canada, it will be your responsibility to bring the Product, at your sole expense, to the ASC for in-warranty repair.

### **Not Covered by this Limited Warranty**

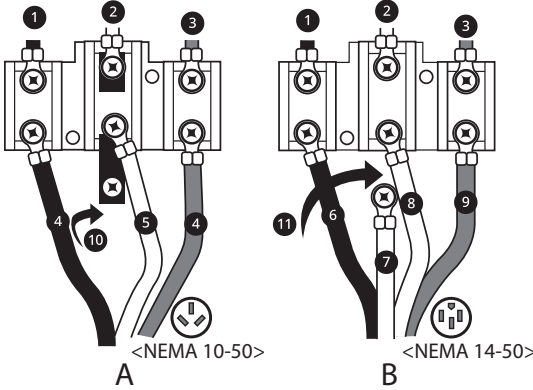
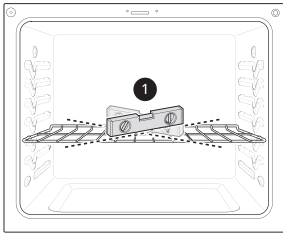
Problem	Possible Cause & Prevention
<p><b>Arcing or Sparking</b></p>	<p><b>Cookware is not microwave safe.</b></p> <ul style="list-style-type: none"> <li>• When in doubt, test cookware before use.</li> </ul>
<p><b>Oven or racks are stained after using aluminum foil</b></p>	<p><b>Aluminum foil has melted in the oven</b></p>  <ul style="list-style-type: none"> <li>• Never cover the oven bottom or cover an entire rack with materials such as aluminum foil.</li> <li>• If the foil has already melted onto the oven, it will not affect the performance of the oven.</li> </ul>
<p><b>Unit has no power</b></p>	<ol style="list-style-type: none"> <li><b>1. House power turned off (power supply)</b> <ul style="list-style-type: none"> <li>• Check power at main board before calling for service.</li> </ul> </li> <li><b>2. Tripped breaker</b> <ul style="list-style-type: none"> <li>• Match power cord type and outlet type.</li> </ul> </li> <li><b>3. The power cord is not installed properly.</b> <ul style="list-style-type: none"> <li>• Properly install the power cord.</li> </ul> </li> </ol>  <ul style="list-style-type: none"> <li>• A: 3-WIRE HOOK UP</li> <li>• B: 4-WIRE HOOK UP</li> <li>• ① Black ② White ③ Red ④ Outer wire</li> <li>• ⑤ Center wire (neutral) ⑥ Black wire</li> <li>• ⑦ Green ground wire ⑧ White wire (neutral)</li> <li>• ⑨ Red wire ⑩ Ground strap ⑪ Remove ground strap</li> </ul>
<p><b>Surface is not level Oven is tipping</b></p>	<p><b>Oven not leveled</b></p>  <ul style="list-style-type: none"> <li>• Check with installer first.</li> <li>• Use carpenter's level ① to check level.</li> </ul>

**The cost of repair or replacement under the above excluded circumstances shall be borne by the consumer.**

TO OBTAIN WARRANTY SERVICE AND ADDITIONAL INFORMATION, PLEASE CALL OR VISIT OUR WEBSITE:

Call 1-888-542-2623 (8 am - 9 pm EST, 365 days) and select the appropriate option from the menu, or visit our website at <http://www.lg.com>

## PROCEDURE FOR RESOLVING DISPUTES

EXCEPT WHERE PROHIBITED AT LAW (INCLUDING WITH RESPECT TO QUÉBEC, BRITISH COLUMBIA AND ONTARIO CONSUMERS), ALL DISPUTES BETWEEN YOU AND LG ARISING OUT OF OR RELATING IN ANY WAY TO THIS LIMITED WARRANTY OR THE PRODUCT SHALL BE RESOLVED EXCLUSIVELY THROUGH BINDING ARBITRATION, AND NOT IN A COURT OF GENERAL JURISDICTION. EXCEPT WHERE PROHIBITED AT LAW (INCLUDING WITH RESPECT TO QUÉBEC, BRITISH COLUMBIA AND ONTARIO CONSUMERS), YOU AND LG BOTH IRREVOCABLY AGREE TO WAIVE THE RIGHT TO A JURY TRIAL AND TO BRING OR PARTICIPATE IN A CLASS ACTION.

**Definitions.** For the purposes of this section, references to “LG” mean LG Electronics Canada, Inc., its parents, subsidiaries and affiliates, and each of their officers, directors, employees, agents, beneficiaries, predecessors in interest, successors, assigns and suppliers; references to “dispute” or “claim” shall include any dispute, claim or controversy of any kind whatsoever (whether based in contract, tort, statute, regulation, ordinance, fraud, misrepresentation or any other legal or equitable theory) arising out of or relating in any way to the sale, condition or performance of the product or this Limited Warranty.

**Notice of Dispute.** In the event you intend to commence an arbitration proceeding, you must first notify LG in writing at least 30 days in advance of initiating the arbitration by sending a letter to LGECI Legal Team at 20 Norelco Drive, North York, Ontario, Canada M9L 2X6 (the “Notice of Dispute”). You and LG agree to engage in good faith discussions in an attempt to amicably resolve your claim. The notice must provide your name, address, and telephone number; identify the product that is the subject of the claim; and describe the nature of the claim and the relief being sought. If you and LG are unable to resolve the dispute within 30 days of LG’s receipt of the Notice of Dispute, the dispute shall be resolved by binding arbitration in accordance with the procedure set out herein. You and LG both agree that, during the arbitration proceeding, the terms (including any amount) of any settlement offer made by either you or LG will not be disclosed to the arbitrator until the arbitrator determines the dispute.

**Agreement to Binding Arbitration and Class Action Waiver.** Upon failure to resolve the dispute during the 30 day period after LG’s receipt of the Notice of Dispute, you and LG agree to resolve any claims between you and LG only by binding arbitration on an individual basis, unless you opt out as provided below, or you reside in a jurisdiction that prevents full application of this clause in the circumstances of the claims at issue (in which case if you are a consumer, this clause will only apply if you expressly agree to the arbitration). To the extent permitted by applicable law, any dispute between you and LG shall not be combined or consolidated with a dispute involving any other person’s or entity’s product or claim. More specifically, without limitation of the foregoing, except to the extent such a prohibition is not permitted at law, any dispute between you and LG shall not under any circumstances proceed as part of a class or representative action. Instead of arbitration, either party may bring an individual action in small claims court, but that small claims court action may not be brought on a class or representative basis except to the extent this prohibition is not permitted at law in your province or territory of jurisdiction as it relates to the claims at issue between you and LG. This does not apply to consumers in Ontario, British Columbia and Québec. In accordance with provincial legislation, the consumer and LG may agree to resolve the dispute using any procedure available, including commencing the action before the competent courts of those provinces.

**Arbitration Rules and Procedures.** To begin arbitration of a claim, either you or LG must make a written demand for arbitration. The arbitration will be private and confidential, and conducted on a simplified and expedited basis before a single arbitrator chosen by the parties under the provincial or territorial commercial arbitration law and rules of the province or territory of your residence. You must also send a copy of your written demand to LG at LG Electronics, Canada, Inc., Attn: Legal Department- Arbitration, 20 Norelco Drive, North York, Ontario M9L 2X6. This arbitration provision is governed by your applicable provincial or territorial commercial arbitration legislation. For consumers in Ontario, British Columbia and Québec, the applicable arbitration legislation only applies if consumers agree to submit the dispute to arbitration. Judgment may be entered on the arbitrator’s award in any court of competent jurisdiction. All

issues are for the arbitrator to decide, except that, issues relating to the scope and enforceability of the arbitration provision and to the arbitrability of the dispute are for the court to decide. The arbitrator is bound by the terms of this provision.

**Governing Law.** The law of the province or territory of your purchase shall govern this Limited Warranty and any disputes between you and LG except to the extent that such law is preempted by or inconsistent with applicable federal or provincial/territorial law. Should arbitration not be permitted for any claim, action, dispute or controversy between you and LG, you and LG attorn to the exclusive jurisdiction of the courts of the province or territory of your purchase for the resolution of the claim, action, dispute or controversy between you and LG.

**Fees/Costs.** You do not need to pay any fee to begin an arbitration. Upon receipt of your written demand for arbitration, LG will promptly pay all arbitration filing fees unless you seek more than \$25,000 in damages, in which case the payment of these fees will be governed by the applicable arbitration rules. Except as otherwise provided for herein, LG will pay all filing, administration and arbitrator fees for any arbitration initiated in accordance with the applicable arbitration rules and this arbitration provision. If you prevail in the arbitration, LG will pay your attorneys' fees and expenses as long as they are reasonable, by considering factors including, but not limited to, the purchase amount and claim amount. Notwithstanding the foregoing, if applicable law allows for an award of reasonable attorneys' fees and expenses, an arbitrator can award them to the same extent that a court would. If the arbitrator finds either the substance of your claim or the relief sought in the demand is frivolous or brought for an improper purpose (as measured by the applicable laws), then the payment of all arbitration fees will be governed by the applicable arbitration rules. In such a situation, you agree to reimburse LG for all monies previously disbursed by it that are otherwise your obligation to pay under the applicable arbitration rules. Except as otherwise provided for, LG waives any rights it may have to seek attorneys' fees and expenses from you if LG prevails in the arbitration.

**Hearings and Location.** If your claim is for \$25,000 or less, you may choose to have the arbitration conducted solely (1) on the basis of documents submitted to the arbitrator, (2) through a telephonic hearing, or (3) by an in-person hearing as established by the applicable arbitration rules. If your claim exceeds \$25,000, the right to a hearing will be determined by the applicable arbitration rules. Any in-person arbitration hearings will be held at the nearest, most mutually-convenient arbitration location available within the province or territory in which you reside unless you and LG both agree to another location or agree to a telephonic arbitration.

**Severability and Waiver.** If any portion of this Limited Warranty (including these arbitration procedures) is unenforceable, the remaining provisions will continue in full force and effect to the maximum extent permitted by applicable law. Should LG fail to enforce strict performance of any provision of this Limited Warranty (including these arbitration procedures), it does not mean that LG intends to waive or has waived any provision or part of this Limited Warranty.

**Opt Out.** The arbitration provision requires you and LG to resolve disputes by binding arbitration instead of court, unless the laws of your province or territory do not permit that, or, in other jurisdictions, if you choose to opt out. The arbitration provision does not apply to consumers in Ontario, British Columbia and Québec.

For individuals that fall within the binding arbitration provisions, you may opt out of this dispute resolution procedure. If you opt out, neither you nor LG can require the other to participate in an arbitration proceeding. To opt out, you must send notice to LG no later than 30 calendar days from the date of the first consumer purchaser's purchase of the product by either (i) sending an e-mail to [optout@lge.com](mailto:optout@lge.com), with the subject line: "Arbitration Opt Out;" or (ii) calling 1-800-980-2973. You must include in the opt out e-mail or provide by telephone: (a) your name and address; (b) the date on which the product was purchased; (c) the product model name or model number; and (d) the serial number (the serial number can be found (i) on the product; or (ii) online by accessing [https://www.lg.com/ca\\_en/findmodel\\_serial/](https://www.lg.com/ca_en/findmodel_serial/)).

In the event that you "Opt Out", the law of the province or territory of your residence shall govern this Limited Warranty and any disputes between you and LG except to the extent that such law is preempted by or inconsistent with applicable federal or provincial/territorial law. Should arbitration not be permitted for any claim, action, dispute or controversy between you and LG, you and LG agree to attorn to the exclusive jurisdiction of the courts of the province or territory of your residence for the resolution of the claim, action, dispute or controversy between you and LG.

You may only opt out of the dispute resolution procedure in the manner described above (that is, by e-mail or telephone); no other form of notice will be effective to opt out of this dispute resolution procedure.

---

Opting out of this dispute resolution procedure will not affect the coverage of the Limited Warranty in any way, and you will continue to enjoy the full benefits of the Limited Warranty. If you keep this product and do not opt out, then you accept all terms and conditions of the arbitration provision described above.

**Conflict of Terms.** In the event of a conflict or inconsistency between the terms of this Limited Warranty and the End User License Agreement (“EULA”) in regards to dispute resolution, the terms of this Limited Warranty shall control and govern the rights and obligations of the parties and shall take precedence over the EULA.

# Memo

# Memo



**LG Customer Information Center**

For inquiries or comments,  
visit **www.lg.com** or call:

**1-800-243-0000** U.S.A.

**1-888-542-2623** CANADA

Register your product Online!

**www.lg.com**

**Centro de Información al Cliente LG**

Para consultas o comentarios, visite  
**www.lg.com** o llame por teléfono:

**1-800-243-0000** EE.UU.

**1-888-542-2623** CANADÁ

¡Registre su producto en línea!

**www.lg.com**

**Centre de Service à la Clientèle de LG**

Pour des questions ou des commentaires,  
visitez **www.lg.com/ca\_fr** ou appelez :

**1-800-243-0000** ÉTATS-UNIS

**1-888-542-2623** CANADA

Enregistrez votre produit en ligne!

**www.lg.com/ca\_fr**