



+ Depending on country / Selon le pays / Según del país

UltraGear™

(OLED Monitor/ Moniteur OLED/ Monitor OLED)

27GX704A

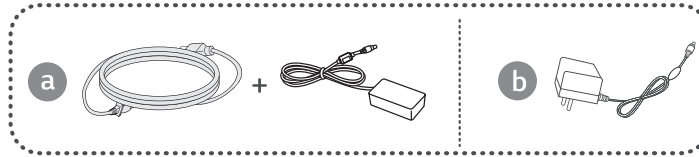
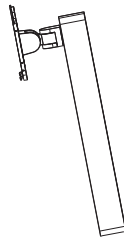
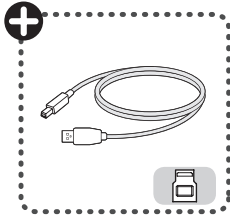
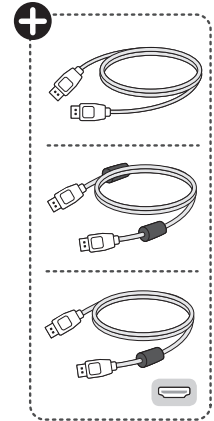
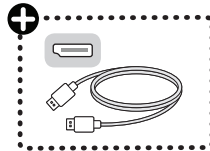

English Quick Setup Guide

Please read this manual carefully before operating your set and retain it for future reference.

Français Guide de configuration rapide

Veuillez lire ce guide de configuration rapide attentivement avant d'utiliser votre produit et conservez-le pour pouvoir vous y reporter ultérieurement.

Español Guía Rápida de Configuración

Lea atentamente este manual antes de poner en funcionamiento el equipo y consérvelo para futuras consultas.



* M F L 0 5 7 6 2 4 6 2 *

(2506-REV00)



www.lg.com

Printed in China/
Imprimé en Chine



English

It is recommended that use the supplied components.

Français

Nous vous recommandons d'utiliser les composants fournis.

Español

Se recomienda utilizar los componentes suministrados.



www.lg.com

English

You can download manuals from the LGE website.

Français

Vous pouvez télécharger les manuels sur le site Web de LGE.

Español

Puede descargar los manuales del sitio web oficial de LGE.

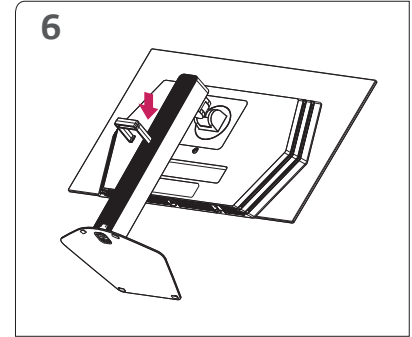
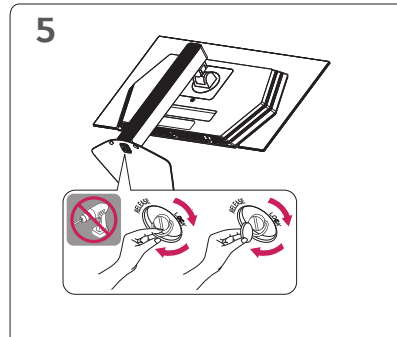
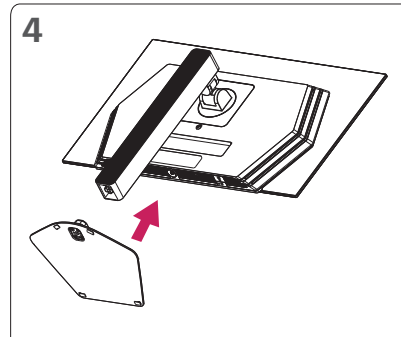
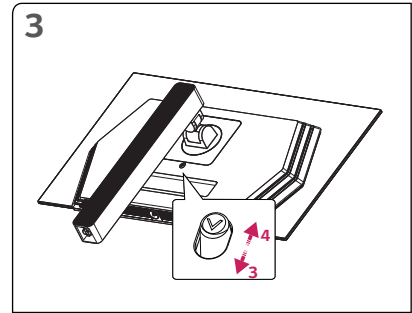
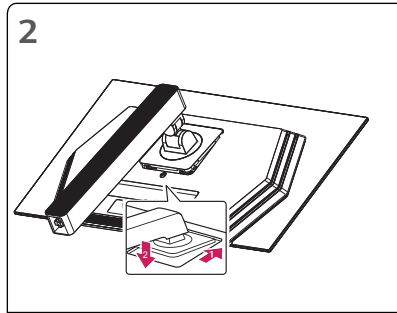
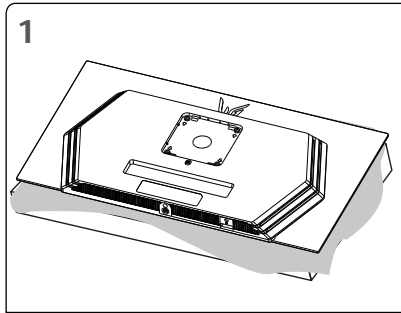
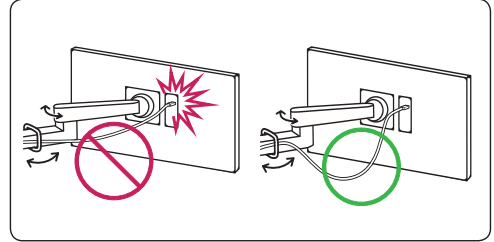
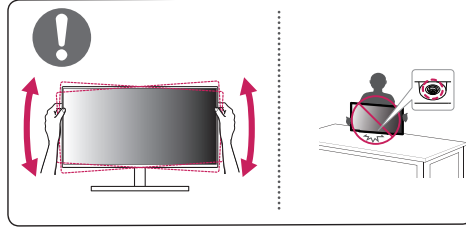
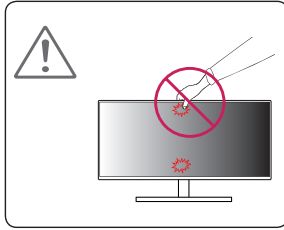

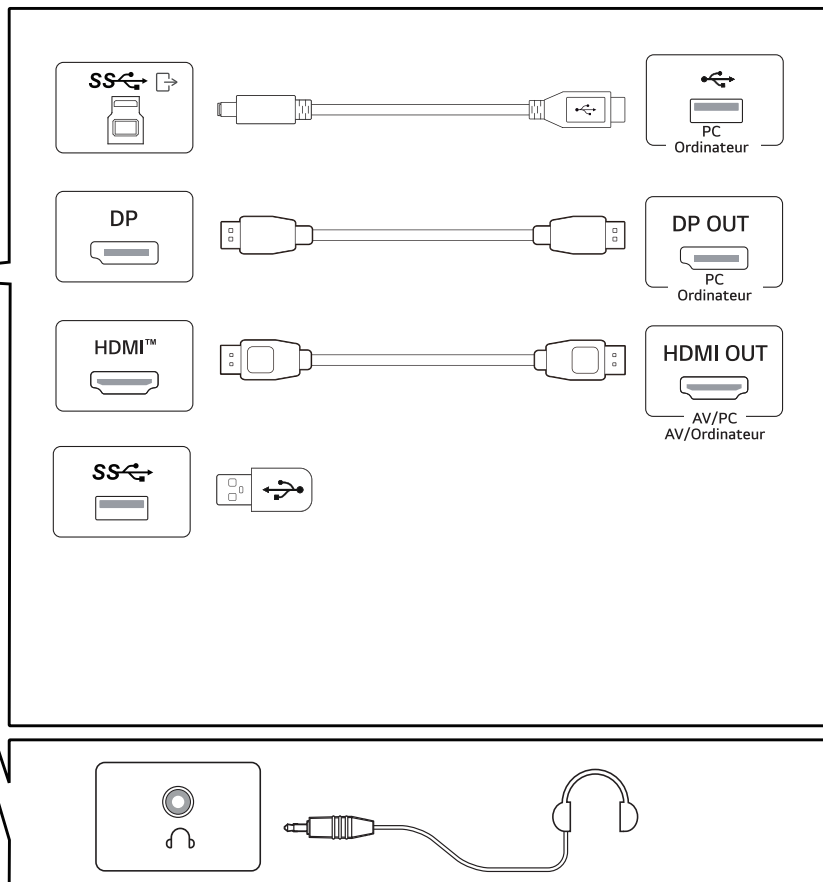
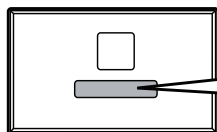



English

- Using a DVI to HDMI / DP (DisplayPort) to HDMI cable may cause compatibility issues.
- The USB port on the product functions as a USB hub.
- Make sure to use the supplied cable. Otherwise, this may cause the device to malfunction.

Français

- L'utilisation d'un câble DVI à HDMI/DP (DisplayPort) à HDMI peut présenter des problèmes de compatibilité.
- Le port USB du produit fonctionne comme un concentrateur USB.
- Assurez-vous d'utiliser le câble fourni avec le produit. Le non-respect de cette consigne peut entraîner un dysfonctionnement du périphérique.

Español

- El uso de un cable de DVI a HDMI / DP (DisplayPort) a HDMI puede causar problemas de compatibilidad.
- El puerto USB del producto funciona como un concentrador USB.
- Asegúrese de utilizar el cable suministrado con el producto. De lo contrario, puede provocar que el dispositivo no funcione correctamente.

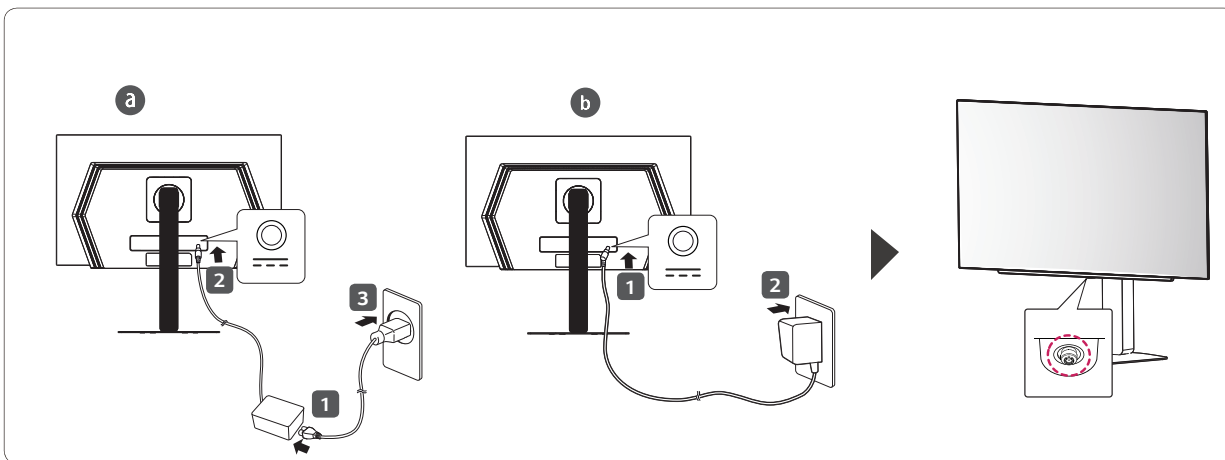



English	Dimensions (Width x Height x Depth)		Weight		Recommended Resolution	Vertical Frequency
	With Stand 605.2 x 532.6 x 220.0 (mm) 23.8 x 20.9 x 8.6 (inches)	Without Stand 605.2 x 351.0 x 45.3 (mm) 23.8 x 13.8 x 1.7 (inches)	With Stand 7.2 (kg) 15.8 (lbs)	Without Stand 4.8 (kg) 10.5 (lbs)		
Français	Dimensions (Largeur x Hauteur x Profondeur)		Poids		Résolution recommandée	Fréquence verticale
	Avec socle 605,2 x 532,6 x 220,0 (mm) 23,8 x 20,9 x 8,6 (po)	Sans socle 605,2 x 351,0 x 45,3 (mm) 23,8 x 13,8 x 1,7 (po)	Avec socle 7,2 (kg) 15,8 (lb)	Sans socle 4,8 (kg) 10,5 (lb)		
Español	Dimensiones (Anchura x Altura x Profundidad)		Peso		Resolución recomendada	Frecuencia vertical
	Soporte incluido 605,2 x 532,6 x 220,0 (mm)	Soporte no incluido 605,2 x 351,0 x 45,3 (mm)	Soporte incluido 7,2 (kg)	Soporte no incluido 4,8 (kg)		
	Alimentación				19 V --- 5,0 A	
	Especificaciones de Adaptador de ca/cc		Salida		19 V --- 5,79 A	
			Entrada		100-240 V~ 50/60 Hz 1,5 A o 1,6 A	



English

• **OLED Monitor's [Image Cleaning] Function and How to Use It**

- Upon initial use after opening, we recommend performing screen calibration using the [Image Cleaning] function.
- If the monitor screen is not clear, run [Image Cleaning].
- For more information, see the owner's manual.

Français

• **Fonction [Nettoyage de l'image] du moniteur OLED et comment l'utiliser**

- Lors de la première utilisation suivant l'ouverture, nous recommandons d'effectuer un étalonnage de l'écran en utilisant la fonction [Nettoyage de l'image].
- Si l'écran du moniteur n'est pas clair, utilisez la fonction [Nettoyage de l'image].
- Pour obtenir de plus amples renseignements, consultez le manuel d'utilisation.

Español

• **Instrucciones para usar la función [Limpieza de imagen] del monitor OLED**

- En el primer uso tras la apertura, recomendamos ejecutar la calibración de la pantalla mediante la función [Limpieza de imagen].
- Si la pantalla del monitor no se ve nítidamente, ejecute [Limpieza de imagen].
- Para obtener más información, consulte el manual de usuario.



English **ARBITRATION NOTICE (USA) / États-Unis seulement**

By using this product, you agree that all disputes between you and LG arising out of or relating in any way to this product (including but not limited to warranty disputes) shall be resolved through binding arbitration on an individual basis, unless the laws of your state or territory do not permit that, or, in other jurisdictions, if you choose to opt out.

Additional information regarding the terms of the arbitration agreement (including details on the procedure for resolving disputes) is available at www.lg.com/us/arbitration (USA) and/or your owner's manual or warranty.

Español **AVISO DE ARBITRAJE (EE. UU.)**

Al utilizar este producto, usted acepta que todas las disputas entre usted y LG que surjan de este producto o se relacionen de alguna manera con él (incluidas, entre otras, las disputas de garantía) se resolverán mediante arbitraje vinculante de forma individual, a menos que las leyes de su estado o territorio no lo permitan, o en otras jurisdicciones, si decide optar por no participar. Los sitios web www.lg.com/us/arbitration (EE. UU.) y/o el manual del propietario o la garantía contienen información adicional sobre los términos del acuerdo de arbitraje (incluidos detalles sobre el procedimiento para resolver disputas).