



OWNER'S MANUAL

LG CineBeam Q

Projector

Please read the safety information carefully before using this product.

PU600U (PU600U-GL)

www.lg.com

Copyright © 2025 LG Electronics Inc. All Rights Reserved.

CONTENTS

READ BEFORE USE

INSTALLATION

- 9 How to use the edge guards
- 10 Projection Distance per Screen Size
- 12 Adjusting the Position of the Projection Screen
- 13 Adjusting the Angle and Focus of the Projection Screen
- 14 Kensington Security System

USING REMOTE CONTROL

- 15 Replacing the Remote Control Battery
- 16 Viewing the Remote Control Features

CONNECTING DEVICES

- 18 Connecting with a HDMI Cable
- 20 Connecting with a USB-C Cable

SAFETY PRECAUTIONS

CHECKING BEFORE REPORTING MALFUNCTION

- 36 Projector Safety Check
- 37 Troubleshooting

CHECKING INFORMATION

- 39 Specifications
- 41 Licenses
- 42 Open Source Software Notice Information
- 43 Other specifications
- 44 Symbols

This manual is produced for public use and may contain images or contents different from the product you purchased.

This manual is subject to change depending on the company's circumstances.

READ BEFORE USE

This product includes both a printed and an electronic user manual. All steps for purchasing and installing the product can be found in the printed user manual, while instructions for using various functions are provided in the electronic version.

User manual

Contains important safety precautions to follow when using the product, as well as instructions for installing and connecting external devices.

Electronic User Manual

To use various functions, please refer to the electronic user manual stored in the product. Using the remote control, please follow the steps below.

 → [] → [Support] → [User Guide]

- LG Electronics is not responsible for any product malfunction or personal injury caused by the use of non-genuine or imitation products.
- Components are subject to change or addition without notice for performance upgrades. Designs or model names are subject to change depending on the manufacturer's circumstances or policies.
- The images shown in this manual may differ from the actual product.

Check Optional Accessories

To purchase these optional accessories, please contact the place of purchase or the LG Customer Service Centre.

- Cables for connecting external devices must be purchased separately.
- Corner protectors must be purchased separately if additional units are needed.
- To purchase the AI remote control, please contact the LG Customer Service Centre.

Parts and Components

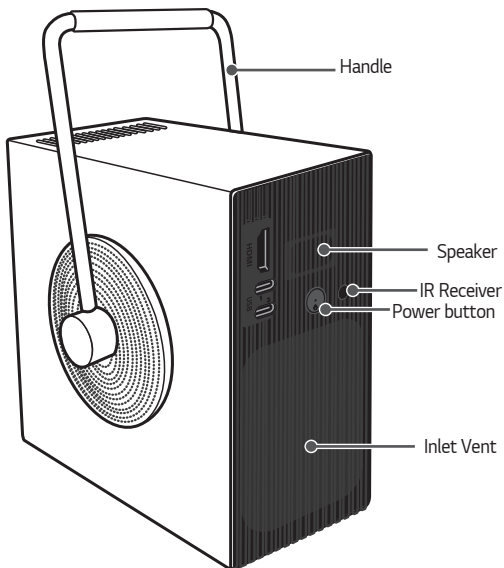

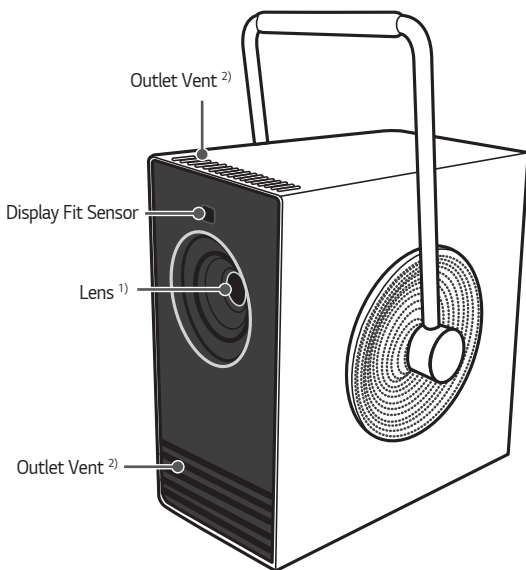

1) Do not touch the lens when using the projector. The lens may be damaged. (Keep lens away from sharp objects.)

2) Due to the high temperature of vent area, do not get close to the vent area.

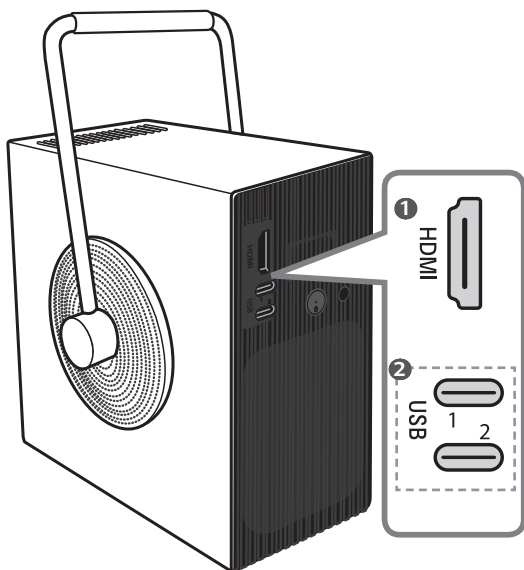

- 1 HDMI Port (HDMI IN)
- 2 USB Port (USB-C)

✓ **NOTE**

- When turning the handle, ensure that the cable is not in the way.
-

Using the Power Button

The projector can be turned on and off with the **Power** button on the product.

- A short press turns it on, a long press turns off all functions and the screen.



NOTE

- The shape and location of the power button may vary depending on the model of the projector.
 - When the power is turned on for the first time, the initialization of the projector may take approximately one minute.
-

Projector Status Indicators

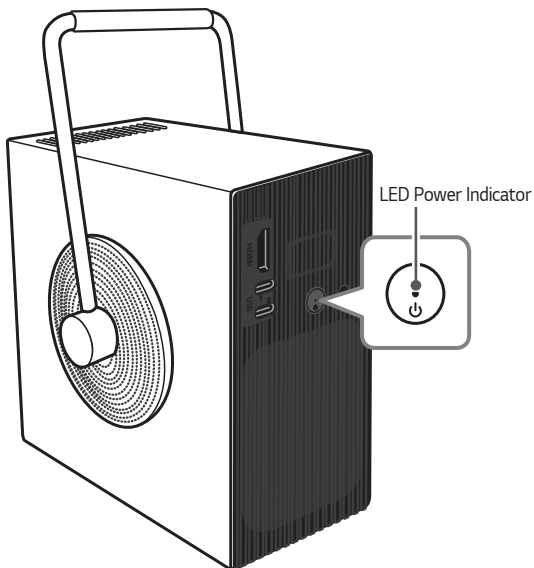

LED Power Indicator	
Red	Power standby state
Off	The projector is operating with the power on.

INSTALLATION

How to use the edge guards

It prevents any damage to the product and injury when being attached to sharp edges of the product.

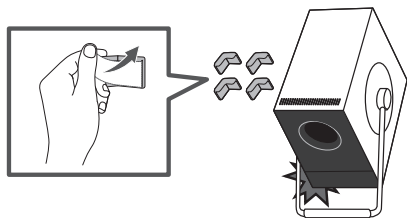
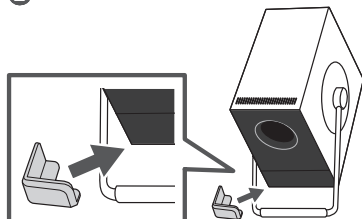
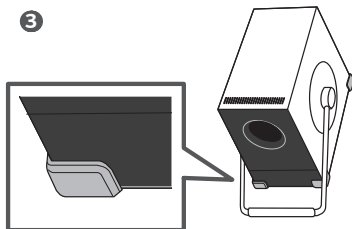
1**2****3**

Projection Distance per Screen Size

- 1 Place the projector on a sturdy, level surface, together with the PC or audio/video source.
- 2 Place the projector an appropriate distance away from the screen. The distance between the projector and the screen determines the actual size of the image.
- 3 Connect the power cord of the projector and the connected device to the wall outlet.

Ratio of upward projection: 100 %

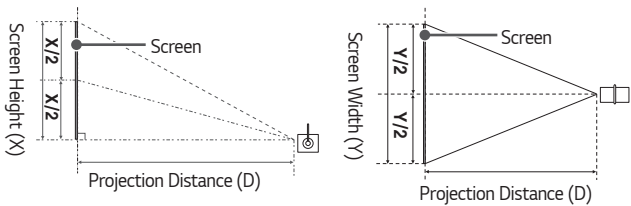

16:9 Aspect Ratio				
Screen Size		Screen Width (Y)	Screen Height (X)	Projection Distance (D)
inches	mm	mm	mm	mm
50	1270	1107	623	1328
60	1524	1328	747	1594
70	1778	1550	872	1860
80	2032	1771	996	2125
90	2286	1992	1121	2391
100	2540	2214	1245	2657
110	2794	2435	1370	2922
120	3048	2657	1494	3188

The projection distance may vary depending on the installation conditions.

NOTE

- If the projected image looks distorted or bent, check to see if the screen is installed properly.

Adjusting the Position of the Projection Screen

Adjust the angle of the projector to adjust the screen position.

- To adjust the angle of the projector, turn the handle to use it.
- When adjusting the angle of the projector, ensure that the projector does not fall backwards. Otherwise, the product may be damaged.
- When adjusting the angle of the projector, be careful not to use an excessive force on the projector. It may damage the projector.

✓ NOTE

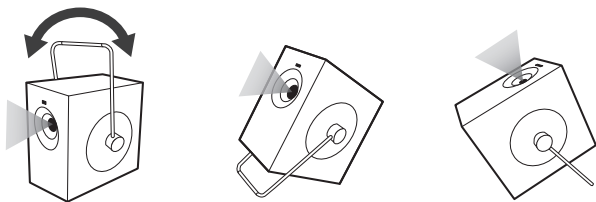

- Ensure that the handle does not cover the screen-customised sensor.
-



Adjusting the Angle and Focus of the Projection Screen



Be careful not to shake the product.

Automatically adjusts the angle and focus of the projection screen of the projector.



 (Q. Settings) →  → [General] → [Installation Wizard] → [Auto Screen Adjustment]

When an image appears on the screen, check if it is in focus and fits the screen properly. If the angle and focus of the projection screen are not adjusted automatically, you can make detailed adjustments manually.

Adjusting the Angle Details of the Projection Screen

 (Q. Settings) →  → [General] → [Installation Wizard] → [Edge Adjustment] / [Keystone]

Adjusting the Focus Details of the Projection Screen

 (Q. Settings) →  → [General] → [Installation Wizard] → [Focus Adjustment]

NOTE

- After using the product at room temperature, turning on the power may blur the focus if the inside temperature is low, but it will recover over time.
- This defocusing is a temporary phenomenon that occurs in low-temperature environments, and this will not affect the product's performance or lifespan.
- The automatic screen calibration feature may encounter an error when the screen is projected onto an uneven surface or due to the material, colour, and surrounding environment.
- The automatic screen calibration feature may malfunction depending on the screen or wall colour when the screen mode is Wall Screen mode.
- Automatic screen correction may malfunction if the projection distance is 2 metres or longer or if the projection angle is 25 degrees or greater.
- If there is an object between the projector and the projected wall or dust or foreign substance in the front (sensor part) of the product, automatic screen correction will not function normally.

Kensington Security System

- This projector has a Kensington Security Standard connector as an anti-theft mechanism. Connect a Kensington Security System cable as shown below.
- For more information on installation and use of the Kensington Security System, refer to the user's guide provided with the Kensington Security System.
- The Kensington Security System is an optional accessory.
- What is Kensington?

Kensington is a company that provides safety systems for laptops and other electronic devices. Website: <http://www.kensington.com>

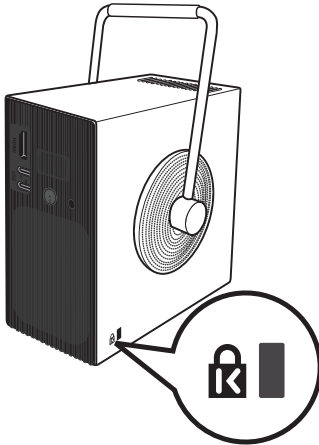

USING REMOTE CONTROL

Replacing the Remote Control Battery

Use 3 V, CR2025 button cell battery. Replace the battery with new one and insert it in the battery tray as shown.

- 1** To separate the battery tray on the back of the remote control, push the hook to the side and then pull it.
- 2** Align the \oplus side of the replacement battery to the battery tray label and insert them correctly.
- 3** Push the battery tray in until it clicks.

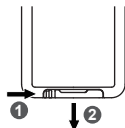

Viewing the Remote Control Features

- Some buttons and services may not be provided depending upon models or regions.

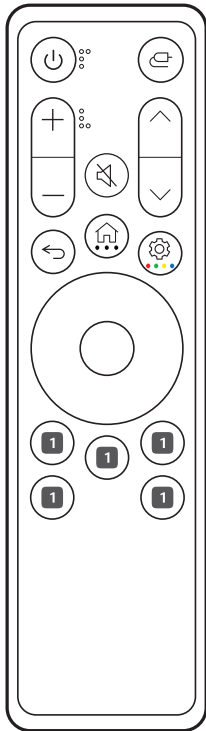

(Power)

Turns the Projector on or off.

(Input)

Changes the input source.

+ / - (Volume Button)

Adjusts the volume level.

(Mute)

Mutes all sounds.

^ / ∨ (Channel Button)

Enables users to change channels.

(Back)

Returns to the previous screen.

(Home)

Accesses the Home menu.

••• (More Actions)

Press and hold the button to view detailed options.

(Q. Settings)

Accesses the Quick Settings.

•••• (Colour Button)

Press and hold the button to access the four colour buttons.

(Up, Down, Left, Right, OK)

Selects menus or options and confirms your input.

Various services button

Connects to various services such as streaming and voice search.

 **NOTE**

- When using the remote control, the optimal operation range is 3 meters or less (left/right) and within a 30 degree arc of the remote control IR receiver.
 - For seamless operation, do not block the IR receiver.
 - When you carry the remote control in the portable bag, make sure that the buttons on the remote control are not pressed by the projector, cables, documents, or any other accessories in the bag. Otherwise, it may significantly reduce the battery life.
-

CONNECTING DEVICES

You can connect various external devices to the projector.

Connecting with a HDMI Cable

Connect an HD receiver, DVD, PC, Notebook, or external devices to the projector and select an appropriate input mode.

With an HDMI cable, you can enjoy high quality picture and sound.

Using a HDMI cable, connect the **HDMI** port of the projector to the HDMI output port of the device to connect. Both video and audio are output at the same time.

- To connect via HDMI, plug in the HDMI cable and select HDMI from the [Home Hub].



- When connecting the HDMI cable to the HDMI input terminal, use a product with a maximum width of 21 mm and height of 12 mm.
- Use a certified cable with the HDMI logo attached.
- If you do not use a certified HDMI cable, the screen may not display or a connection error may occur. (Recommended HDMI cable types)
 - Ultra High Speed HDMI®/™ Cable (3 m or less)

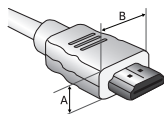

A ≤ 12 mm
B ≤ 21 mm

 **NOTE****ARC (Audio Return Channel)**

- External audio devices that support SIMPLINK and ARC must be connected using **HDMI** port. (⊕)
- When connected with a Ultra High Speed HDMI®/™ Cable, external audio devices that support ARC output or SPDIF work with the SIMPLINK function without the need for an additional optical audio cable.

When connecting PC/laptop

- The projector supports Plug and Play. Your PC will automatically detect the projector and requires no driver installation.
-

Connecting with a USB-C Cable

Connect the USB-C terminal of the projector to the USB-C output terminal of a PC/laptop or smartphone using a USB-C cable.

If the USB device is not recognised when using a USB hub, connect the USB directly to the USB-C™ port.

Contact the manufacturer of your device to see if this feature is supported. Only the smartphones that support USB-C will work.

- Use a certified USB-C™ cable. To connect via USB-C, plug in the USB-C cable and select USB-C from the [Home Hub].

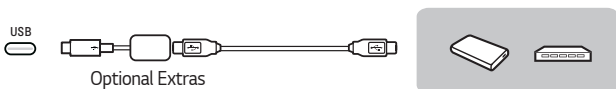

- When connecting the USB cable to the USB input terminal, use a product with a maximum width of 18 mm and height of 8 mm.
- If the size of the USB cable or USB flash drive does not fit the projector USB port, use an extension cable that supports USB 2.0.

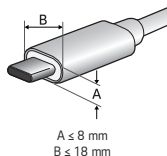

 **NOTE**

- PD (Power Delivery) and DP Alternate Mode are supported.
 - A USB-C gender changer may be necessary depending on the cable used if using PD (Power Delivery).
 - To connect USB A Type products, you need a USB Type A to Type C adapter.
 - The function may not operate properly depending on the connected device's specifications, USB-C cable status, or surroundings.
 - The USB PD (for power supply) function may not operate according to the specifications of the connected equipment.
 - Check the resolution of the connected devices before using the DP Alternate Mode function.
-

Turning Power On with USB-C

To turn the power on using the USB-C input port, the external device (USB PD adapter, charger, battery) must support USB Power Delivery 65 W (20 V/3.25 A) or higher profiles.

Purchase and use a USB-C AC adapter of 65 W (20 V/3.25 A) or higher certified by USB PD through an e-commerce site.



NOTE

- Connecting an adapter with an output lower than the rated adapter may cause the device not to turn on or to operate abnormally.
-

SAFETY PRECAUTIONS

Please take note of the safety instructions to prevent any potential accident or misuse of the projector.

Child injuries can be prevented by following these simple safety precautions.

The precautions should be followed in the same manner when you store or move your existing projector.

- Safety precautions are given in two forms, i.e., **WARNING** and **CAUTION** as detailed below.
 - ⚠ **WARNING:** Failure to follow the instructions may cause serious injury and even death.
 - ⚠ **CAUTION:** Failure to follow the instructions may cause personal injury or product damage.
- Read the owner's manual carefully and keep it on hand.



The lightning flash with arrowhead symbol, within an equilateral triangle, is intended to alert the user to the presence of uninsulated dangerous voltage within the product's enclosure that may be of sufficient magnitude to constitute a risk of electric shock to persons.



The exclamation point within an equilateral triangle is intended to alert the user to the presence of important operating and maintenance (servicing) instructions in the literature accompanying the device.

WARNING/CAUTION

- TO REDUCE THE RISK OF FIRE AND ELECTRIC SHOCK, DO NOT EXPOSE THIS PRODUCT TO RAIN OR MOISTURE.

Read these instructions. Keep these instructions.

Heed all warnings. Follow all instructions.

Indoor Installation

WARNING

Do not install products including projectors and remote controls in the following places:

- Any place exposed to direct sunlight;
 - Any humid place such as bathroom;
 - Any place near hot objects such as flammables and stoves;
 - Any place where oil, oil mist, and steam can reach such as a worktop or places near a humidifier;
 - Any place where water can splash like a vase or the aquarium;
 - Any place that is dusty or exposed to wind and rain;
 - Any place that is under the air conditioner or is directly exposed to the wind from the air conditioner;
 - Any place near flammable materials such as flammable sprays, etc.; or
 - Any cupboard, bookcase shelf or cabinet without a fixture installed and any place where a pet can access.
- It may cause an electric shock, fire, malfunction, deformation or falling.

Be careful not to drop the projector when connecting an external device.

- It may cause injury or damage to the product.

Keep the following precautions in mind to prevent the temperature rise inside the projector:

- Install the air vents at least 30 cm away from the wall.
- Do not install the product in a place where it cannot be ventilated, such as on a bookcase or in a closet.
- Do not install the product on carpet or cushion.
- Make sure that the air vents are not blocked with tablecloths, curtains, etc.
- It may cause a fire.

For places where oil or oil mist can reach, do not install the product on a wall or ceiling.

- The product may be damaged and fall.

Do not allow a child to hang or climb on the installed projector.

- The projector may fall and cause injury or death.



When moving the projector, be sure to turn off the power switch and disconnect the power plug, antenna cable and the connection cord between the devices.

- A failure to do so may cause damage to the projector or the cord, resulting in a fire or electric shock.

Do not install the projector on a shaky shelf, a slanted place, a place subject to vibrations, a place where the projector is not fully supported or on a fabric such as tablecloths.

- It may cause injury as the projector falls or tips over, or it may cause a malfunction of the projector.

To prevent damage to the power cord or plug, do not install the projector where the cord can be walked on.

- It may cause a fire or electric shock.

When installing the projector, do not install it too close to the wall.

- The cable connection may be deteriorated or the projector and its cables may be damaged.

When installing the projector on a cabinet or a shelf, make sure that the front end of the bottom of the projector does not come out.

- The projector may fall due to the unbalance of the centre of gravity and cause injury to people or a malfunction.

When in Use

WARNING

When thunder or lightning strikes, unplug the power cord and do not touch the antenna wire.

- It may cause an electric shock.

If there is a gas leak from the gas lines, do not touch the outlet and be sure to vent by opening the window.

- Sparks may be caused and lead to a fire or burns.

When using the product with an external device connected such as a games console, make sure the connection cable is long enough.

- The product may fall over and cause injury or product damage.

Do not scratch or give an impact on the projector with metallic materials or objects.

- It may cause injury to people or damage to the product.

Do not insert metallic objects including coins, hairpins or a piece of iron or flammable objects such as paper or matches into the projector.

- It may cause a fire or electric shock.

Keep the plastic wrapping of the product out of the reach of children.

- If a child misuses it, it may suffocate the child.

Do not touch near the vents during the operation or immediately after the power is turned off as they generate intense heat.

- The heat does not indicate a defect or a problem of the projector when it is operating so use it with confidence.

Do not look into the front of the lens when the projector is operating. Strong light is projected from the product which can cause injury to your eyes.

Never try to disassemble or modify the projector yourself. Always seek a qualified service technician or consult your dealer or local Service Centre for inspection, adjustment or repairs.

- It may cause a fire or electric shock.

 **CAUTION**

Do not use any product that uses high voltage electricity near the projector. (e.g. An electric fly swatter)

- It may cause a malfunction.

Do not place any liquid containers such as a vase, pot, cup, cosmetics or medicine, decorations such as candles or any heavy objects on top of the projector.

- Doing so may cause a fire, electric shock and injury due to failing.

The surface of the AC adapter is hot, so be careful not to put the surface against your skin or let the children touch the surface during use. (Except for the models that do not use an adapter)

Do not hold or move the projector upside down by grabbing only the power cord, signal cable, or projection mirror.

- Doing so may damage the product or cause an electric shock or fire.

Even if the projector is turned off with the remote control or the button, the power is not completely cut off if the power cord is plugged in.

If you use headphones or earphones, do not use them at high volume or for a long period of time. (It applies only to the models that support headphones (earphones).)

- Doing so may damage your hearing.

Do not start the projector when the volume is high.

- A loud volume can cause hearing loss.

Do not use or store the projector outdoors for an extended period of time.

Do not touch the projector's lens or give an impact on it.

- It may cause damage to the product.

Do not block the light from the projector lens with a person, book or other objects.

- If the light from the projector shines on an object for a long time, it can cause fire due to the heat of such light. Also, the reflected light can heat the lens and cause damage to the projector.

Supervise children and to never allow them to stare into the projector beam at any distance from the projector.

Use caution when using the remote control for staring the projector while in front of the projection lens.

The user to avoid the use of optical aids such as binoculars or telescopes inside the beam.

If the ambient temperature rises above 30 °C, the fan may run faster to protect the internal parts of the projector.

If the ambient temperature exceeds 35 °C, the light output may be reduced to protect the projector.

This product features highly durable tempered glass; however, excessive impact may cause the glass to become scratched or break. Please use with care.

To avoid dropping the projector, always carry it with both hands instead of one.

Battery



WARNING

When replacing the batteries used for the remote control, be careful not to let children eat them and keep the batteries out of reach of children.

- If a child swallows the battery, consult a doctor immediately.

When replacing the batteries, make sure that they are properly installed according to the polarities (+, -).

- Battery rupture or leakage may lead to fire, explosion, injury or contamination (damage) of the surrounding area.

Do not expose the batteries to direct sunlight, fireplace, electric heater, high temperature above 60 °C, excessively humid places or excessive heat.

- It can cause an explosion or fire.

Do not throw or disassemble the battery.

- It can cause a fire and explosion due to battery damage.

Do not carelessly throw away old batteries.

- It can cause an explosion or fire. The disposal method may vary by country and region. Dispose of it in an appropriate manner.

“Do not swallow the battery. There is a risk of chemical burns.”

- The remote control provided with this product contains a coin/button cell battery. If swallowed, the coin/button cell battery can cause severe internal burns and death within just two hours.
- Keep both new and used batteries out of reach of children.
- If the battery compartment does not close securely, stop using the product and keep it out of reach of children.
- If you suspect that a battery has been swallowed or inserted into the body, seek medical attention immediately.

Do not dispose of the battery in a fire or a hot oven, or crush or cut it mechanically. Doing so may cause it to explode.

The battery must not be exposed to excessive heat, such as direct sunlight or fire.

Risk of fire or explosion if the battery is replaced by an incorrect type.

Power



Make sure the power plug is securely plugged in to prevent it from shaking.

- If the connection is unstable, it may cause a fire.

Do not plug too many devices into one multi-power outlet.

- This may result in fire due to the power outlet overheating.

Do not insert a metal object such as chopsticks into the other end of the power plug while it is plugged into a wall outlet. Also, do not touch the power plug immediately after unplugging it from the outlet.

- It can cause an electric shock.

Connect the power plug to a grounded outlet or multi-power outlet. (Except for any device without ground connection)

- A failure to do so may cause an electric shock due to a malfunction or electrical short.

Never touch the power plug with wet hands.

- It may cause an electric shock.

Disconnect the power plug from the outlet when you are not using the projector for a long time or absent.

- Dust collects and may cause an electric shock and fire caused by a short circuit due to heat, ignition and insulation/degradation.

The Power Plug is the disconnecting device. In case of an emergency, the Power Plug must remain readily accessible.

If any of the following occurs, it could be a malfunction of the product, so you must immediately turn the projector off, unplug the power cord from the outlet, and contact the service centre:

- When the product is damaged;
 - When the product fails;
 - When there is a foreign substance inside the product; or
 - When the product smokes or smells.
- It may cause a fire or electric shock.

 **CAUTION**

Do not unplug or plug the power plug from/in the outlet while the power switch is on. (Do not use the power plug as a switch.)

- It may cause a fire or malfunction.

When removing the AC adapter or power cord, be sure to hold the plug part.

- A failure to do so may cause a fire or damage to the product.

Do not damage the AC adapter, power cord or power plug, place heavy objects on them or give an impact on them.

- It may cause a fire, electric shock or damage to the product.

Attach the power cord and AC adapter connected to the projector in a way that they are fully seated.

- Poor contact can cause a malfunction of the product and fire.

If there is dust on the pin part of the power plug or the outlet, clean it thoroughly.

- It may cause a fire.

Keep the power cord away from heat sources.

- The coating of the cord may melt and cause a fire or electric shock.

Use only the authorised power cord or AC adapter supplied by LG Electronics. Do not use any other products.

- It may cause a malfunction of the product, fire or electric shock.

Cleaning

WARNING

Do not spray water directly onto the projector when cleaning it.

- It may cause a fire or electric shock.

CAUTION

How to clean the projector

- Disconnect the plug from the outlet before cleaning.
- Do not wipe the optical system (the lens and mirror) immediately after the power is turned off.
- Do not spray the water with a sprayer on the product or wipe the product with a damp cloth.
- Wipe the product gently with a soft cloth.
- Do not use any detergents, automotive or industrial polishes, abrasives, waxes, benzenes or alcohols.
- It may cause a fire, electric shock or damage to the projector (deformation, corrosion, and breakage).

How to clean the lens

- Clean the lens if any dust or smudge appears on the surface of the lens.
- Clean the surface of the lens with an air sprayer or a soft, dry cloth.
- To remove dust or stains on the lens, use a compressed air duster, cotton swab, or soft cloth to gently wipe the lens.
- Never clean the lens when the projector is operating or immediately after the projector is turned off.
- Do not use any detergents, automotive or industrial polishes, abrasives, waxes, benzenes, alcohols, water, etc. on the lens, as they will damage the projector.

Consult your dealer or the service centre for cleaning the interior of the product once a year.

- If you do not clean the interior of the projector for a long time while dust collects, it may cause a fire or malfunction.

Laser

WARNING

- You risk being exposed to laser radiation if you manipulate or alter the product in a way not specified in the user manual.
- Be sure not to let infants or people with diseases directly watch the light source.

CAUTION

- This product is a class 1 laser device that meets IEC 60825-1.

Built-in laser standard (class 4 laser module)

- Blue
 - Wavelength: 458 nm - 472 nm
 - Light output: Approx. 10.4 W
- Green
 - Wavelength: 519 nm - 531 nm
 - Light output: Approx. 6.4 W
- Red
 - Wavelength: 635 nm - 651 nm
 - Light output: Approx. 11.0 W

Product Laser Class Label

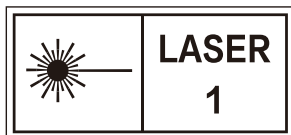

IEC 60825-1:2014

The laser class label of product is attached to the bottom of the product.
Product labels are affixed to the underside of the product.

CHECKING BEFORE REPORTING MALFUNCTION

Please check the list below when you experience the following symptoms during use of the product. It may not be a failure.

Projector Safety Check

Symptoms

- The projector does not display anything on the screen or output sound when it is turned on.
- The product emits smoke or a burning smell.
- Water or foreign substances are present inside the product.
- Part of the projected image is cut out.
- A strange noise (crackling or sparking sound) regularly occurs from inside the projector.
- The projector still displays the screen or outputs sound when it is turned off.
- There are other errors or failures.

Causes and Solutions

- For safety, turn off the power switch and remove the plug from the socket.
- Contact the place of purchase or authorised service centre for product inspection.
- Do not attempt to repair the product yourself.





Troubleshooting

Symptoms	Causes and Solutions
I cannot turn on the Projector.	<ul style="list-style-type: none"> • Please make sure your projector power plug is correctly connected to the outlet. • There may be a problem with the outlet, so try plugging the power cord of another product into the outlet where the projector was plugged in.
Cannot control the Projector with the remote control.	<ul style="list-style-type: none"> • The remote control may not work properly where a lamp with electronic stabiliser or a three-wavelength lamp is installed. <ul style="list-style-type: none"> — In this case, replace the lamp with electronic stabiliser or the three-wavelength lamp with international standard products to ensure the remote control works properly. • Check if there is any obstacle between the product and the remote control. • When replacing the batteries, make sure that they are properly installed according to the polarities (+, -). • Replace both used batteries with new ones. • For remote controls that use coin batteries, ensure the insulation sheet between the battery and the terminal has been removed.
The power turns off suddenly.	<ul style="list-style-type: none"> • Check whether the [Sleep Timer], [Auto Off], or [Auto Power Off] is set. • See if the external devices are operating together. • The auto-off function may have been activated. This product is equipped with an auto-off function that automatically turns the product off when no signal is present and when the remote control has not been pressed, depending on the settings for the auto-off function.

Symptoms	Causes and Solutions
<p>I see dots on the screen.</p>	<ul style="list-style-type: none"> • There is a coloured dot (bright dots, dark dots, stationary dots, and/or flickering dots) on the screen. <ul style="list-style-type: none"> – This projector was produced with high precision technology. However, a tiny dark or bright dot may appear on the screen. This is a common occurrence due to the production process, and it does not indicate a functional failure. <p>* Bright spot: brightly lit dots, Dark spot: invisible or blurred point of text or objects, Blinking: flashing dots, Bright dot: glowing dots that are brighter than regular images</p>
<p>I hear a noise.</p>	<ul style="list-style-type: none"> • Electrical noise: This is a small sound generated from the operation of the high-speed switching circuit that supplies current to the projector, and the noise may vary depending on the product. This noise is normal and does not affect the projector's functions. LG Electronics manages the manufacturing of projectors according to strict standards. A fixed level of noise does not indicate a problem. Please understand that this does not allow you to get an exchange or refund. • Fan sound: To maintain the temperature inside the projector at an appropriate level, the fan sound may increase or decrease depending on the ambient temperature.

CHECKING INFORMATION

Specifications

MODEL	PU600U (PU600U-GL)
Resolution (Pixel)	3840 (Horizontal) x 2160 (Vertical) ¹⁾
Aspect ratio	16:9 (Horizontal:Vertical)
Projection distance – Screen size	1328 mm to 3188 mm – 1270 mm to 3048 mm (50 inches to 120 inches)
Ratio of upward projection	100 %
Working range of the remote control	3 m
Power consumption	65 W ²⁾
AC-DC Adaptor	Manufacturer: Honor Model: ADT-65AI-D00-3
	Input: 100-240 V~ 50/60 Hz 1.6 A (Max.) Output (USB-PD): 20.0 V  3.25 A 65.0 W (Max.) or 5.0 V  3.0 A 15.0 W or 9.0 V  3.0 A 27.0 W or 15.0 V  3.0 A 45.0 W

- 1) 4K UHD resolution with 8.3 million discrete pixels projected by XPR (Extended Pixel Resolution) video processing.
- 2) Power consumption levels may vary depending on the operating conditions and projector settings. Power consumption is measured according to internal standards (full white pattern, maximum resolution).

MODEL	PU600U (PU600U-GL)	
Audio Output	4 W (Mono)	
Height	135 mm (without foot), 136.5 mm (with foot)	
Width	80 mm (without handle cap), 107.8 mm (with handle cap)	
Depth	135 mm	
Weight	1.49 kg	
USB Device	USB Type-C	Output: 5 V, 1 A (Max.)
		Input: 20 V, 3.25 A (Min.)
Environment Condition	Temperature	
	Operation	0 °C to 40 °C
	Storage	-20 °C to 60 °C
	Relative Humidity	
	Operation	0 % to 80 %
	Storage	0 % to 85 %

- Use only power supplies listed in the user instructions.
- Contents in this manual may be changed without prior notice due to upgrade of product functions.

Licenses

Supported licenses may differ by model. For more information about licenses, visit www.lg.com.



The terms HDMI, HDMI High-Definition Multimedia Interface, HDMI trade dress and the HDMI Logos are trademarks or registered trademarks of HDMI Licensing Administrator, Inc.

Manufactured under license from Dolby Laboratories. Dolby, Dolby Vision, Dolby Vision IQ, Dolby Audio, Dolby Atmos, and the double-D symbol are trademarks of Dolby Laboratories Licensing Corporation.



USB Type-C® and USB-C® are registered trademarks of USB Implementers Forum. USB 2.0 Type-C™ is a trademark of USB Implementers Forum.

Open Source Software Notice Information

To obtain the source code that is contained in this product, under GPL, LGPL, MPL, and other open source licenses that have the obligation to disclose source code, and to access all referred license terms, copyright notices and other relevant documents, please visit <https://opensource.lge.com>.

LG Electronics will also provide open source code to you on CD-ROM for a charge covering the cost of performing such distribution (such as the cost of media, shipping, and handling) upon email request to opensource@lge.com.

This offer is valid to anyone in receipt of this information for a period of three years after our last shipment of this product.

Other specifications













This label is attached to the bottom of the product and language may differ.

As with any bright light source, do not stare into the beam, RG2 IEC 62471-5:2015.

Risk Group 2

CAUTION Possibly hazardous optical radiation emitted from this product. Do not stare at operating lamp. May be harmful to the eye.

Symbols

	Refers to alternating current (AC).
	Refers to direct current (DC).
	Refers to class II equipment.
	Refers to stand-by.
	Refers to "ON" (power).
	Refers to dangerous voltage.
	CAUTION
	Instructions
	Coin / button cell battery
	Caution, Shock hazard

