

OLED55G1PUA    OLED65G1PUA    OLED77G1PUA

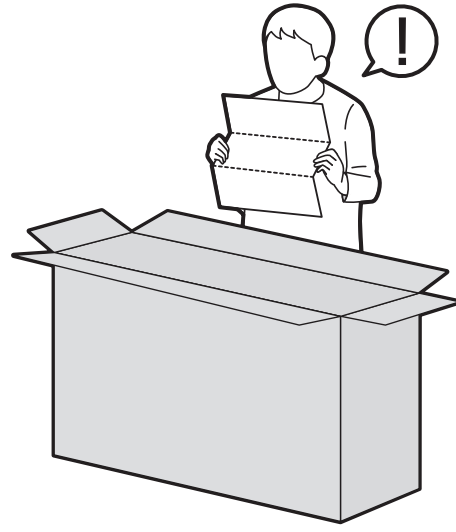

1-A OLED55G1\*

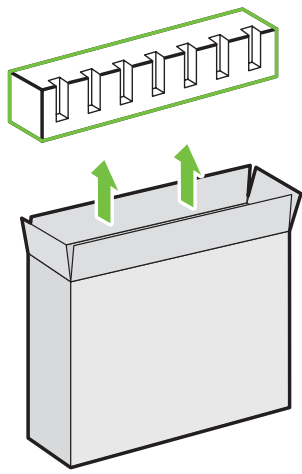

1-B OLED65G1\*

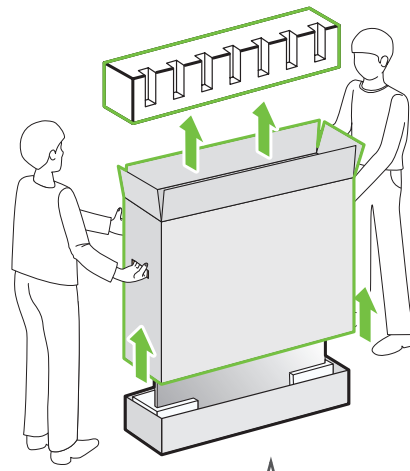

1-C OLED77G1\*

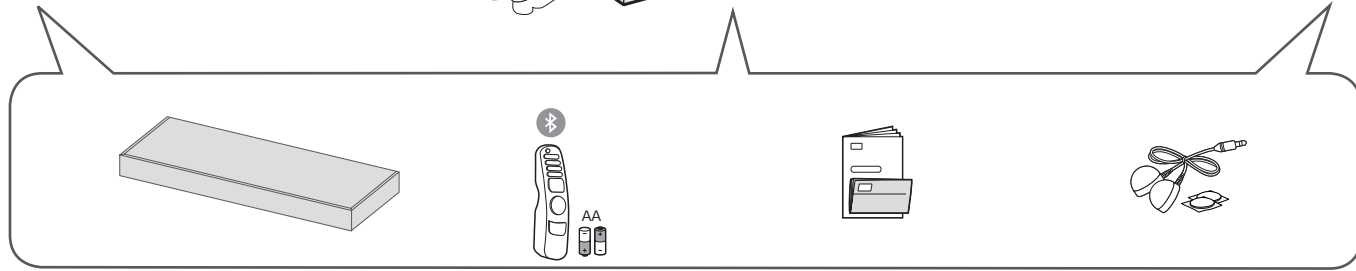
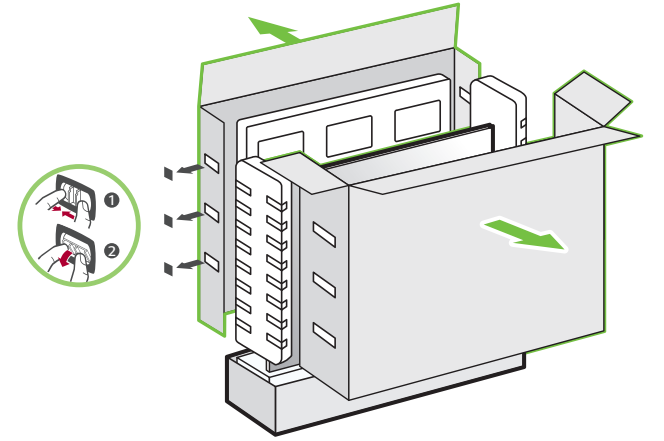

2-A OLED55G1\*

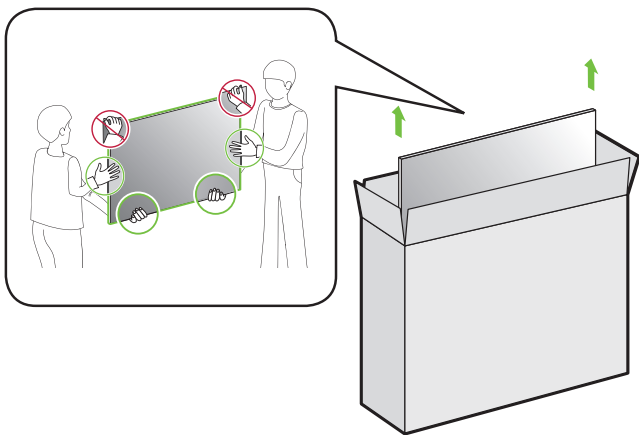

2-B OLED65/77G1\*

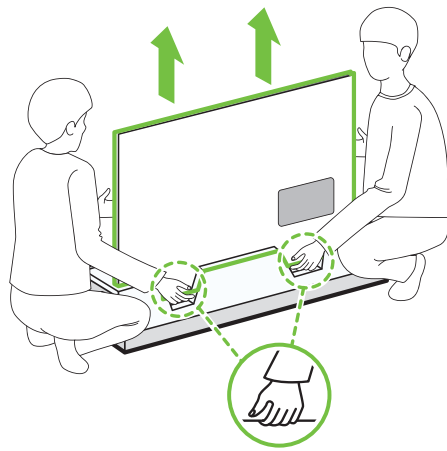

3

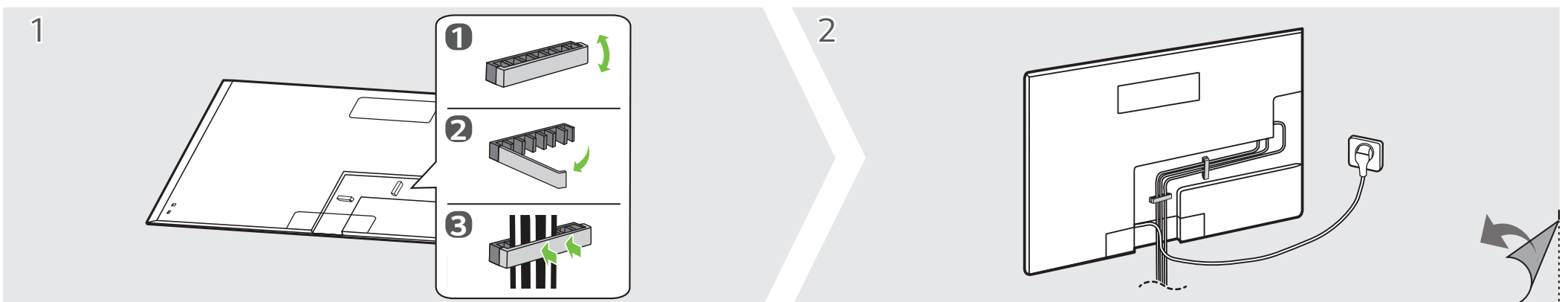
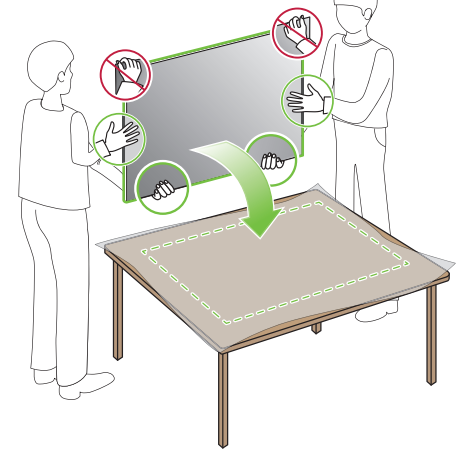

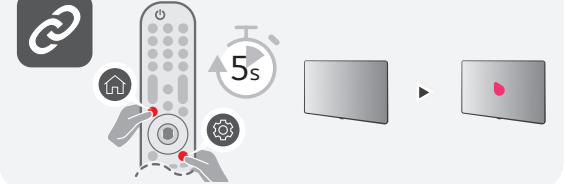
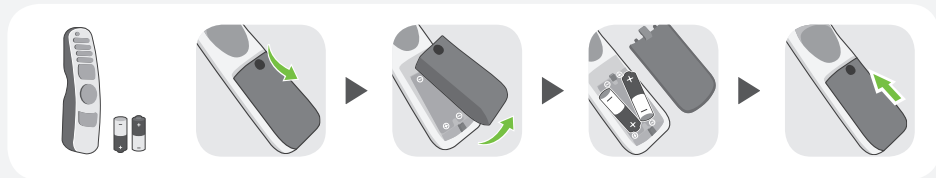
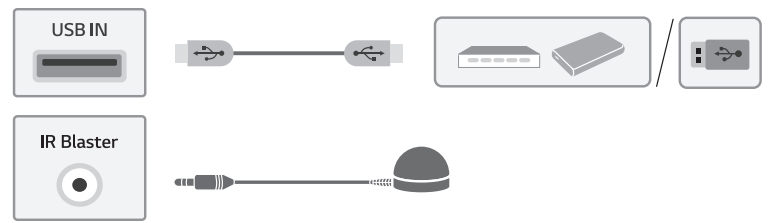
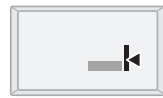
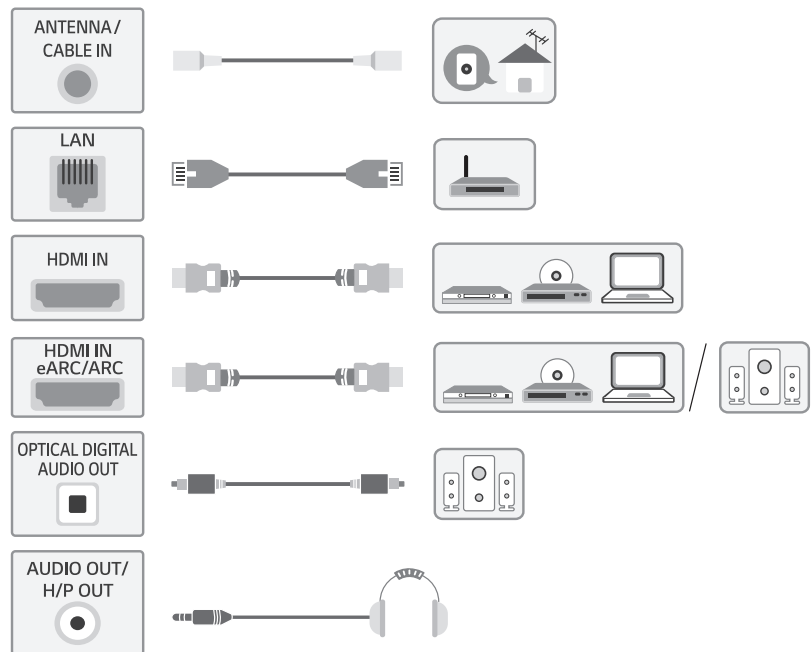

A, B, C, D, E, F : mm (inches / pulgadas / po)  
G, H : kg (lbs / libras / lb)

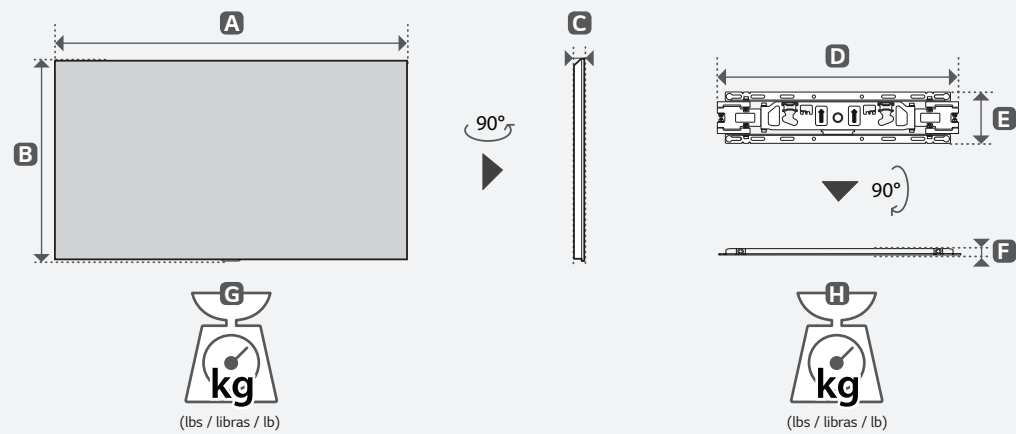

MODELS MODELOS MODÈLES	A		B		C		D		E		F		G		H		Power consumption	
	Consumo de potencia		Consumo de potencia		Consumo de potencia		Consumo de potencia		Consumo de potencia		Consumo de potencia		Consumo de potencia		Consumo de potencia		Consumo de potencia	
	Consumo de potencia		Consumo de potencia		Consumo de potencia		Consumo de potencia		Consumo de potencia		Consumo de potencia		Consumo de potencia		Consumo de potencia		Consumo de potencia	
OLED55G1PUA	1,225 (48.2)	1 225 (48,2)	706 (27.7)	706 (27,7)	23.1 (0.9)	23,1 (0,9)	452 (17.7)	452 (17,7)	96 (3.7)	96 (3,7)	13 (0.5)	13 (0,5)	21.8 (48.0)	21,8 (48,0)	1.0 (2.2)	1,0 (2,2)	369 W	
OLED65G1PUA	1,446 (56.9)	1 446 (56,9)	830 (32.6)	830 (32,6)	19.9 (0.7)	19,9 (0,7)	452 (17.7)	452 (17,7)	96 (3.7)	96 (3,7)	13 (0.5)	13 (0,5)	29.0 (63.9)	29,0 (63,9)	1.0 (2.2)	1,0 (2,2)	471 W	
OLED77G1PUA	1,721 (67.7)	1 721 (67,7)	991 (39.0)	991 (39,0)	24.1 (0.9)	24,1 (0,9)	452 (17.7)	452 (17,7)	96 (3.7)	96 (3,7)	13 (0.5)	13 (0,5)	39.4 (86.8)	39,4 (86,8)	1.0 (2.2)	1,0 (2,2)	692 W	
Power requirement / Alimentación requerida / Alimentation													AC 120 V- 50/60 Hz					



**ENGLISH** Read **Safety and Reference**.

**ESPAÑOL** Leer **Seguridad y Consultas**.

**FRANÇAIS** Lisez **Sécurité et références**.

**ENGLISH**

**Easy Setup Guide**

Please read this manual carefully before operating your set and retain it for future reference.

**ESPAÑOL**

**Guía Rápida de Configuración**

Lea atentamente este manual antes de poner en marcha el equipo y consérvelo para futuras consultas.

**FRANÇAIS**

**Guide de configuration rapide**

Avant d'utiliser l'appareil, veuillez lire attentivement ce manuel et le conserver pour pouvoir vous y reporter ultérieurement.