

70NANO77SRA 75NANO77SRA 86NANO77SRA

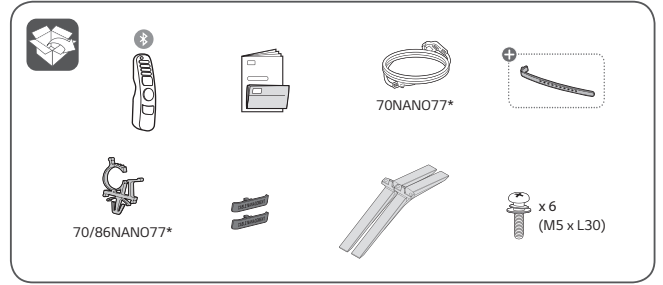

⊕ Dependendo do modelo

1-A
70NANO77*
75NANO77*

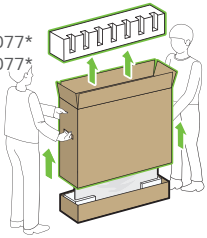

1-B
86NANO77*

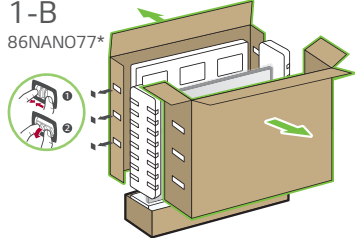

2

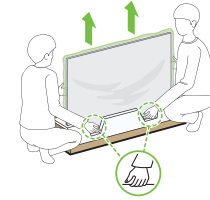

3

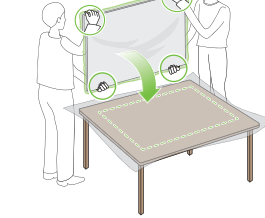

4

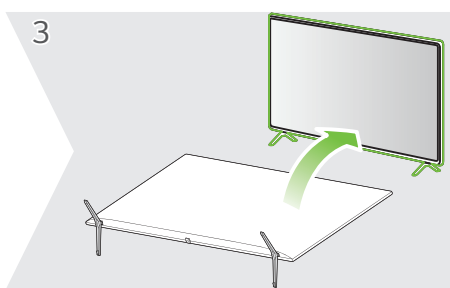
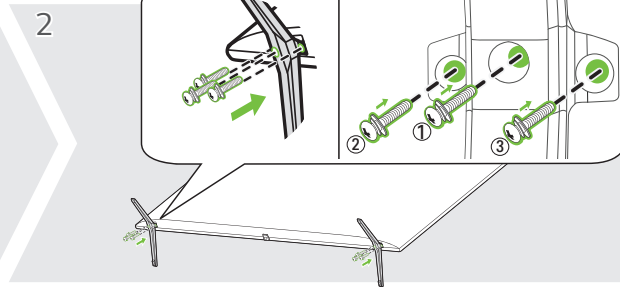
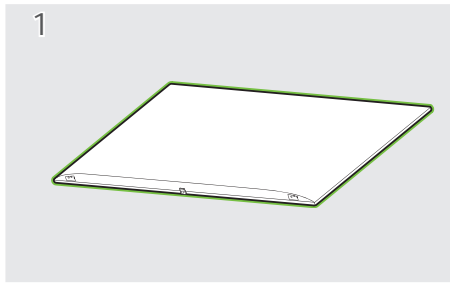

4-A 70NANO77*

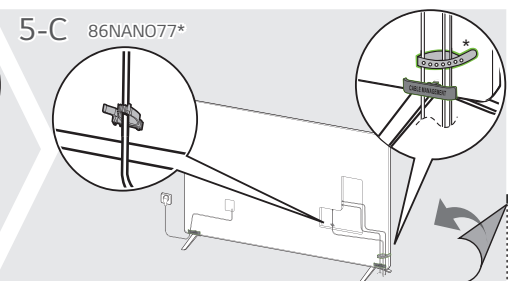
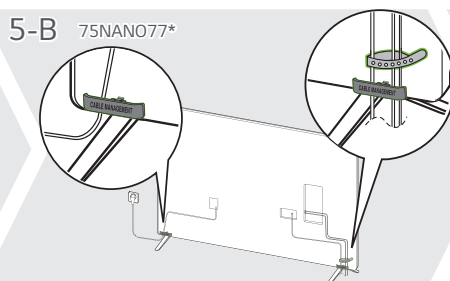
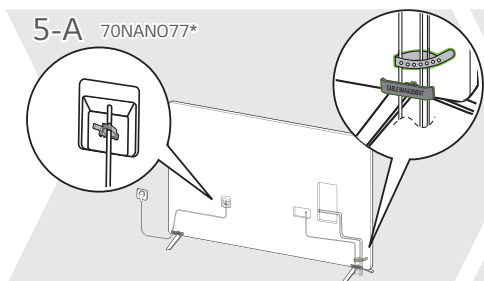
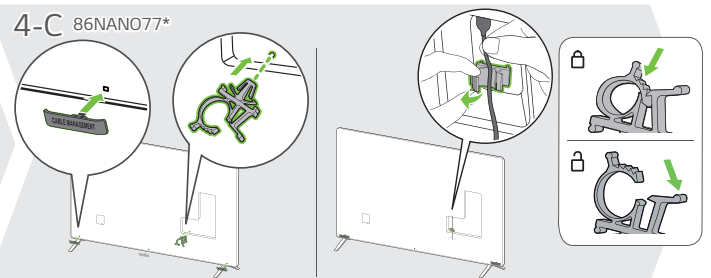
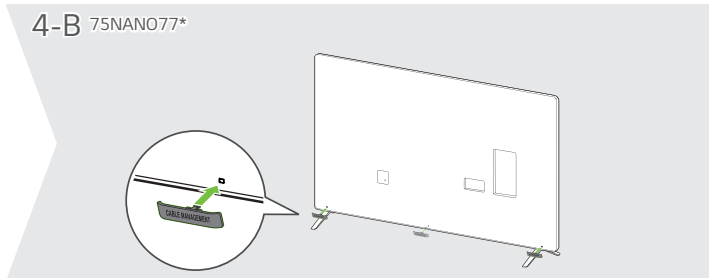
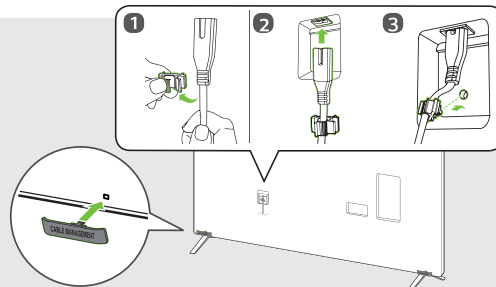

*Dependendo do modelo

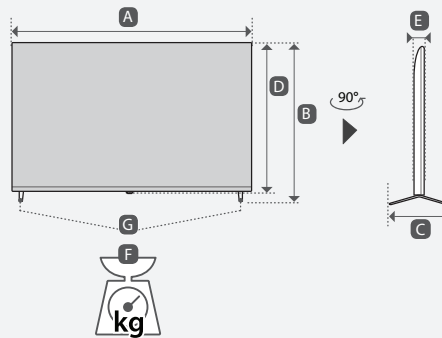
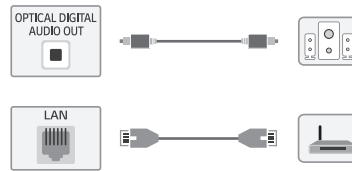
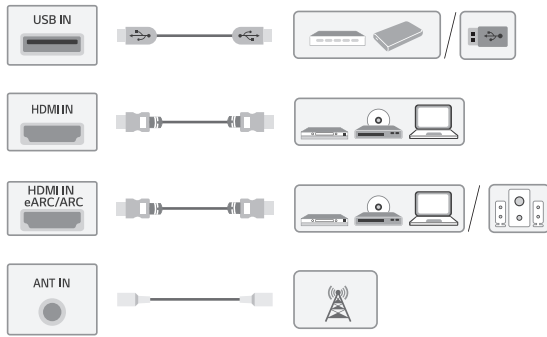

PRODUZIDO NO POLO INDUSTRIAL DE MANAUS
 CONHEÇA A AMAZÔNIA
LG Electronics do Brasil Ltda.
 CNPJ: 01.166.372/0008-21
 Rua Javari, nº 1004, Distrito Industrial, CEP 69075-110, Manaus/AM, Indústria Brasileira

MODELOS	A	B	C	D	E	F	F - G	Consumo de potência
70NANO77SRA	1 562 mm (61.4) pol.	972 mm (38.2) pol.	361 mm (14.2) pol.	907 mm (35.7) pol.	59.9 mm (2.3) pol.	28.1 kg (61.9) lbs	27.7 kg (61) lbs	210 W
75NANO77SRA	1 678 mm (66) pol.	1 027 mm (40.4) pol.	361 mm (14.2) pol.	964 mm (37.9) pol.	59.9 mm (2.3) pol.	31.8 kg (70.1) lbs	31.4 kg (69.2) lbs	250 W
86NANO77SRA	1 927 mm (75.8) pol.	1 167 mm (45.9) pol.	361 mm (14.2) pol.	1 104 mm (43.4) pol.	59.9 mm (2.3) pol.	45.9 kg (101.1) lbs	45.2 kg (99.6) lbs	335 W

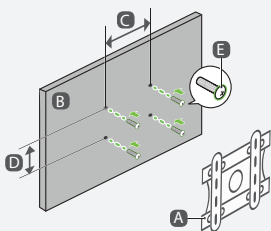

A	B	C x D	E
LSW440B	70NANO77* 75NANO77*	400 x 400 mm (15.7 x 15.7) pol.	M6
LSW640B	86NANO77*	600 x 400 mm (23.6 x 15.7) pol.	M8

A / E Não incluso no produto

