



OWNER'S MANUAL

# LG Digital Signage (MONITOR SIGNAGE)

Please read this manual carefully before operating your set and retain it for future reference.

86BH5C

86BH7C

[www.lg.com](http://www.lg.com)

Copyright © 2017 LG Electronics Inc. All Rights Reserved.

# TABLE OF CONTENTS

## IMPORTANT PRECAUTIONS.....3

- Electrical Power Related Precautions.....3
- Precautions for installing the Product.....5
- Precautions for Moving the Product.....6
- Precautions for Using/Cleaning the Product....7
- On Disposal  
(Only, Hg lamp used LCD Monitor) .....7

## LICENSES.....8

## ASSEMBLY AND PREPARATION..... 10

- Optional Accessories.....11
- Parts and Buttons.....13
- External Equipment Setup.....13
  - IR Receiver
- Portrait Layout.....14
- Remove Protective Plastic Film from Sides  
before Installation .....14
- Installing on a Wall.....16

## REMOTE CONTROL ..... 18

## MAKING CONNECTIONS..... 20

- Connecting to a PC.....20
- External Device Connection.....20
- Connecting Multiple Monitors.....22
- Using the Input List .....23

## TROUBLESHOOTING..... 24

## PRODUCT SPECIFICATIONS..... 27

# IMPORTANT PRECAUTIONS

Please read these safety precautions carefully before using the product.

## **WARNING**

Failure to follow those warnings may result in death, serious injury or damage to the product or other property.

## **CAUTION**

If you ignore the caution message, you may be slightly injured or the product may be damaged.

## **WARNING**

- Indoor Use Only.

## Electrical Power Related Precautions

### **WARNING**

- Use only the power cord supplied with the unit or another manufacturer's authorized cord.
  - Failure to do so may result in fire or electrical shock or damage to the product.
- Use only a properly grounded plug and receptacle.
  - If you do not you may be electrocuted or injured. Or the product might be damaged.
- Do not use a damaged or loose plug.
  - This may cause electrical shock or fire.
- Operate the display only from a power source(i.e. voltage) indicated in the product specification.
  - Otherwise the product can be damaged, fire can occur or you may be electrocuted. If you are not sure what type of power supply you have, consult a certified electrician.
- In the presence of thunder and lightning, never touch the power cord and signal cable because it can be very dangerous.
  - It can cause electric shock.
- Do not connect several extension cords, electrical appliances or electrical heaters to a single outlet. Use a power bar with a grounding terminal designed for exclusive use with the computer.
  - A fire can break out due to overheating.
- Do not touch the power plug with wet hands. Additionally, if the cord pin is wet or covered with dust, dry the power plug completely or wipe dust off before plugging in the cord.
  - You may be electrocuted due to excess moisture.
- If you don't intend to use the product for a long time, unplug the power cable from the product.
  - Covering dust can cause a fire, or insulation deterioration can cause electric leakage, electric shock or fire.
- Insert the power plug firm so it cannot come loose.
  - A loose connection can cause fire.

- Hold the plug when pulling out the power cable. Do not pull the plug out by the wire. Do not bend the power cord with excessive force or put heavy objects on the power cord.
  - The power line can be damaged, which may cause electric shock or fire.
- Do not insert metal or other conductive materials into the product openings. Additionally, do not touch the power cable right after plugging into the wall input terminal.
  - You may be electrocuted.
- The appliance coupler is used as the disconnect device.
- Please make sure the device is installed near the wall outlet to which it is connected and that the outlet is easily accessible.
- Do not unplug the power cord while the product is in use.
  - Electrical shock can damage the product.
- As long as this unit is connected to the AC wall outlet, it is not disconnected from the AC power source even if the unit is turned off.

## Precautions for installing the Product

### WARNING

- Keep away from heat sources like heaters or open flames.
  - Electrical shock, fire, malfunction or deformation may occur.
- Keep the packing anti-moisture material or vinyl packing out of the reach of children.
  - Anti-moisture material is harmful if swallowed. If swallowed by mistake, force the patient to vomit and visit the nearest hospital. Additionally, vinyl packing can cause suffocation. Keep it out of the reach of children.
- Do not put heavy objects on the product or sit upon it.
  - If the product collapses or is dropped, you may be injured. Children must pay particular attention.
- Do not leave the power or signal cable where someone can trip over it.
  - The passerby can falter, which can cause electrical shock, fire, product breakdown or injury.
- Install the product in a neat and dry place. Do not use near water.
  - Dust or moisture can cause electrical shock, fire or product damage.
- Do not add accessories that have not been designed for this display.
- If you smell smoke or other odors or hear a strange sound from the product unplug the power cord and contact LG Customer Service.
  - If you continue to use without taking proper measures, electrical shock or fire can occur.
- If you dropped the product or the case is broken, turn off the product and unplug the power cord.
  - If you continue to use without taking proper measures, electrical shock or fire can occur. Contact LG Customer Service.
- Do not drop an object on or apply impact to the product. Do not throw any toys or objects at the product.
  - It can cause injury to humans, problems to the product and damage the display.
- Keep out of reach of children and do not place toys near the product.
- Make sure the product ventilation hole is not blocked. Install the product more than 100 mm (3.9 inches) from the wall.
  - If you install the product too close to the wall, it may be deformed or fire can break out due to internal heat build-up.
- Do not cover the product with cloth or other material (eg. plastic) while plugged in.
  - The product can be deformed or fire can break out due to internal overheating.
- Place the product on a flat and stable surface that is large enough to support the product.
  - If the product is dropped, you may be injured or the product may be broken.
- Install the product where no Electromagnetic Interference occurs.
- Keep the product away from direct sunlight.
  - The product can be damaged.
- Do not place the product on the floor.
  - Small Children and others may trip over it.
- Do not install this product on a wall if it could be exposed to oil or oil mist.
  - This may damage the product and cause it to fall.
- For displays with glossy bezels the user should consider the placement of the display as the bezel may cause disturbing reflections from surrounding light and bright surfaces.

## Precautions for Moving the Product

### **WARNING**

- Make sure to turn off the product.
  - You may be electrocuted or the product can be damaged.
- Make sure to remove all cables before moving the product.
  - You may be electrocuted or the product can be damaged.
- When lifting or moving the product, do not hold it upside down while holding only the stand.
  - This may cause the product to fall resulting in damage or injury.
- Do not shock the product when moving it.
  - You may be electrocuted or the product can be damaged.
- Make sure the panel faces forward and hold it with both hands to move.
  - If you drop the product, the damaged product can cause electric shock or fire.
- Do not place the product face down.
  - This may damage the TFT-LCD screen.

## Precautions for Using/Cleaning the Product

### ⚠ WARNING

- Do not attempt to disassemble, repair or modify the product yourself.
  - Fire or electric shock can occur.
  - Contact LG Customer Service for repair.
- When cleaning the product, unplug the power cord and scrub gently with a soft cloth to prevent scratching. Do not clean with a wet cloth or spray water or other liquids directly onto the product. An electric shock may occur. (Do not use chemicals such as benzene, paint thinners or alcohol)
- Keep the product away from water.
  - Fire or electric shock accident can occur.
- Avoid high temperatures and humidity.
- Do not put or store flammable substances near the product.
  - There is a danger of explosion or fire.
- Keep the product clean at all times.
- Take a comfortable and natural position when working with the product.
- Take a regular break when working with the product for a long time.
- Do not press on the panel with hands or sharp object such as nail, pencil or pen, or make a scratch on it.
- Keep proper distance from the product and rest from time-to-time.
  - Your vision may be impaired if you look at the product too closely or for too long.
- Set the appropriate resolution by referring to the User's Guide.
- Keep small accessories out of the reach of children.
- Displaying a still image for long time on the monitor may leave persistent image or stain on the monitor screen. To avoid this problem, use a screen saver and power off when this product is not used. Persistent image or stain caused by long time usage are not covered by the warranty on this product.
- Do not place products using high voltage around the Monitor. (ex. Electrical Swatter)
  - Monitor may have malfunction as its electrical shock.
- Spray water onto a soft cloth 2 to 4 times, and use it to clean the front frame; wipe in one direction only. Too much moisture may cause staining.

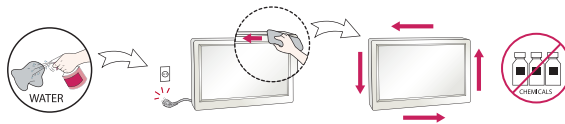

## On Disposal (Only, Hg lamp used LCD Monitor)

- The fluorescent lamp used in this product contains a small amount of mercury.
- Do not dispose of this product with general household waste.
- Disposal of this product must be carried out in accordance to the regulations of your local authority.

## LICENSES

Supported licenses may differ by model. For more information of the licenses, visit [www.lg.com](http://www.lg.com).



The terms HDMI and HDMI High-Definition Multimedia Interface, and the HDMI logo are trademarks or registered trademarks of HDMI Licensing LLC in the United States and other countries.



This DivX Certified® device has passed rigorous testing to ensure it plays DivX® video. To play purchased DivX movies, first register your device at [vod.divx.com](http://vod.divx.com). Find your registration code in the DivX VOD section of your device setup menu.

DivX Certified® to play DivX® video up to HD 1080p, including premium content.

DivX®, DivX Certified® and associated logos are trademarks of DivX, LLC and are used under license.

Covered by DivX Patents 7,295,673; 7,515,710; RE45,052; and others available at [[www.divx.com/patents](http://www.divx.com/patents)]



Manufactured under license from Dolby Laboratories. Dolby and the double-D symbol are trademarks of Dolby Laboratories.

For DTS patents, see <http://patents.dts.com>. Manufactured under license from DTS Licensing Limited. DTS, the Symbol, & DTS and the Symbol together, DTS 2.0 Channel, DTS 2.0+Digital Out, DTS-HD, and DTS Virtual:X are registered trademarks or trademarks of DTS, Inc. in the United States and/or other countries. © DTS, Inc. All Rights Reserved.



# ASSEMBLY AND PREPARATION

## CAUTION

- Always use genuine components to ensure safety and product performance.
- The product warranty will not cover damage or injury caused by the use of counterfeit components.

## NOTE

- The accessories provided with your product may vary depending on the model or region.
- Product specifications or contents in this manual may be changed without prior notice due to upgrade of product functions.
- SuperSign Software & Manual
  - Download from the LG Electronics website.
  - Visit the LG Electronics website (<http://partner.lge.com>) and download the latest software for your model.
- The warranty will not cover any damage caused by using the product in an excessively dusty environment.

## Optional Accessories

Without prior notice, optional accessories are subject to change to improve the performance of the product, and new accessories may be added. The illustrations in this manual may differ from the actual product and accessories.

### Media Player kit

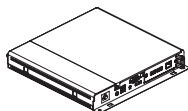

Media Player  
MP500 / MP700



Screws



CD (Owner's Manual) / Cards

### OPS kit

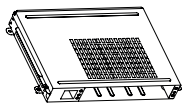

KT-OPSA

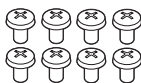

Screws

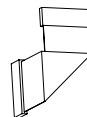

Connecting Cable



Card (Easy Setup Guide)

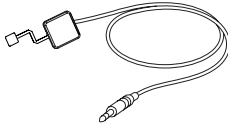

Power Cord

**Pixel sensor kit****KT-SP0****Wi-Fi Dongle kit****AN-WF500****! NOTE**

- Cable holder/cable tie may not be available in some areas or for some models.
- Optional accessories are available for some models. If necessary, please purchase them separately.
- Pixel sensor is sold separately. You can obtain additional accessories from an authorized LG Parts distributor.
- Before you attach the OPS kit or Media Player, connect the cable to the port.

## Parts and Buttons

The image may be different according to the model.

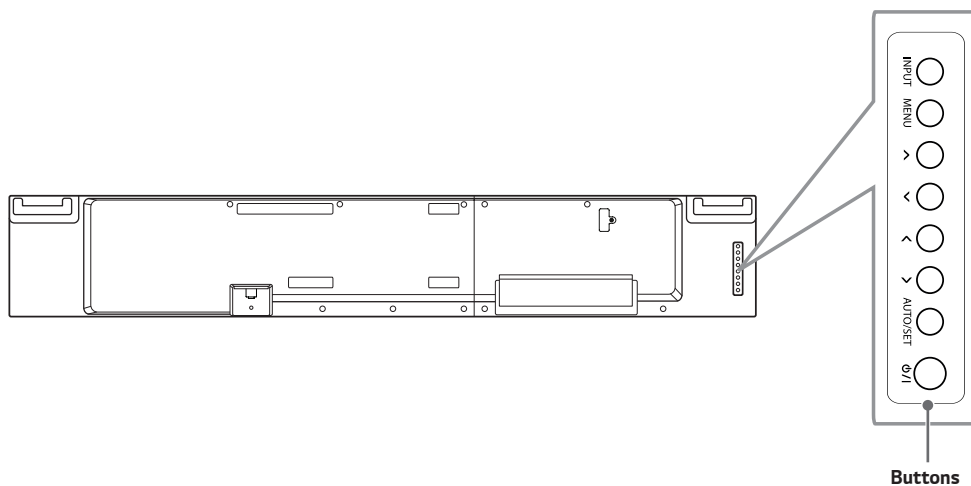

- **INPUT:** Changes the input source.
- **MENU:** Accesses the main menus, or saves your input and exits the menus.
- **∇/△:** Adjust the up and down.
- **◀/▶:** Moves left and right.
- **AUTO/SET:** Displays the current signal and mode.
- **⏻/⏿:** Turns the power on or off.

## External Equipment Setup

### IR Receiver

This allows a remote control sensor to be placed in a custom location. When configured correctly, display can control other displays via an RS-232C cable.

## Portrait Layout

When installing in a portrait layout, rotate the monitor counterclockwise 90 degrees (when facing the screen).

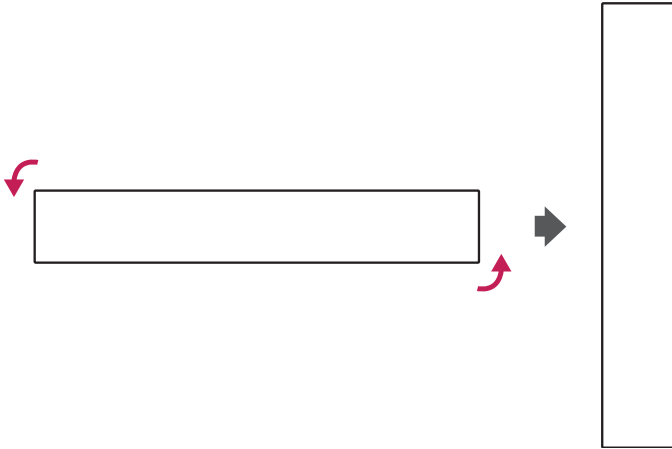

## Remove Protective Plastic Film from Sides before Installation

Make sure that the protective plastic film is removed from each corner before installing the product.



### Using Kensington Lock

(This is not available for all models.)

The Kensington security system connector is located at the back of the monitor. For more information on installation and use of this system, refer to the manual provided with the Kensington security system or visit <http://www.kensington.com>.

Connect the Kensington security system cable between the monitor and a table.

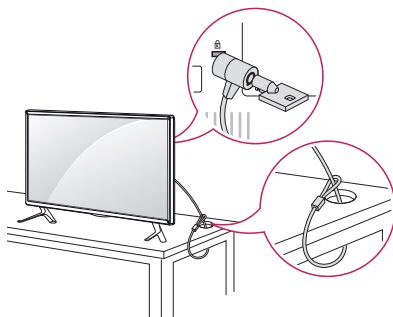

### ! NOTE

- The Kensington security system is optional. You can obtain additional accessories from most electronics retail stores.

## Installing on a Wall

For proper ventilation, allow a clearance of 100 mm (3.9 inches) on each side and from the wall. Detailed installation instructions are available from your dealer, see the optional Tilt Wall Mounting Bracket Installation and Setup Guide.

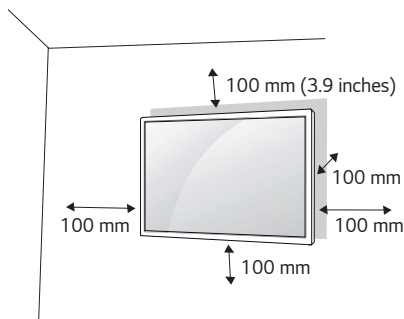

To install your monitor on a wall, attach a wall mounting bracket (optional part) to the back of the monitor.

Make sure that the wall mounting bracket is securely attached to the monitor and to the wall.

- 1 Use only screws and wall mounting brackets that conform to VESA standards.
- 2 Screws which are longer than standard length may damage the inside of the monitor.
- 3 A non-VESA standard screw may damage the product and cause the monitor to fall. LG Electronics is not liable for any accidents related to the use of non-standard screws.
- 4 Please use VESA standard as below.
  - 785 mm (30.9 inches) and above
  - \* Mounting Screws: Diameter 8.0 mm x Pitch 1.25 mm x Length 14 mm (Max: 18 mm)  
(Diameter 0.3 inches x Pitch 0.04 inches x Length 0.5 inches (Max: 0.7 inches))

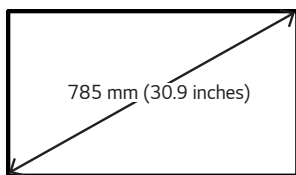

### CAUTION

- Disconnect the power cord before moving or installing the monitor to avoid risk of electric shock.
- If you install the monitor on a ceiling or slanted wall, it may fall and result in injury.
- Do not over tighten the screws as this may damage the monitor and void your warranty.
- Use only screws and wall mounting brackets that meet the VESA standard. Any damage or injuries caused by misuse or use of improper accessories are not covered by the warranty.
- If you want to install the monitor on the wall with the media player and OPS kit attached, leave a space of at least 45 mm (1.7 inches). Otherwise, interference may occur.

### Securing the monitor to a wall (optional)

(Procedure may differ depending on the model.)

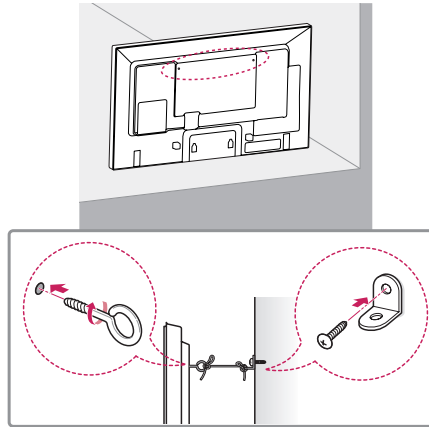

- 1 Insert and tighten the eyebolts, or brackets and bolts on the back of the monitor.
  - If there are already bolts inserted in the eyebolts' position, remove the other bolts first.
- 2 Mount the wall brackets with the bolts to the wall. Match the location of the wall bracket and the eyebolts on the rear of the monitor.
- 3 Connect the eyebolts and wall brackets tightly with a sturdy cord. Make sure the securing cord is horizontal with the flat surface.

### **!** WARNING

- If the monitor is not positioned in a sufficiently stable location, there is a chance that it may fall. Many injuries, particularly to children, can be avoided by taking simple precautions such as:
  - Using cabinets or stands recommended by the manufacturer.
  - Only using furniture that can safely support the monitor.
  - Ensuring the monitor is not overhanging the edge of the supporting furniture.
  - Not placing the monitor on tall furniture (for example, cupboards or bookcases) without anchoring both the furniture and the monitor to a suitable support.
  - Not placing cloth or other materials between the monitor and supporting furniture.
  - Educating children about the dangers of climbing on furniture to reach the monitor or its controls.

### **!** CAUTION

- Make sure that children do not climb on or hang from the monitor.

### **!** NOTE

- Use a platform or cabinet that is large and strong enough to support the monitor securely.
- Brackets, bolts, and cords are sold separately. You can obtain additional accessories from your local retail store.
- The illustration shows a general example of installation and may look different from the actual product.

# REMOTE CONTROL

The descriptions in this manual are based on the buttons on the remote control. Please read this manual carefully to use the monitor correctly.

To install batteries, open the battery cover, place batteries (1.5 V AAA) matching ⊕ and ⊖ terminals to the labels inside the compartment, and close the battery cover.

To remove the batteries, perform the installation actions in reverse. The illustrations may differ from the actual accessories.

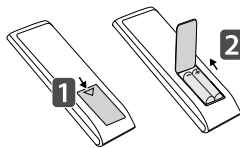

## ⚠ CAUTION

- Do not mix old and new batteries, as this may damage the remote control.
- Be sure to point the remote control toward the remote control sensor on the monitor.
- Some features of the remote control may not be supported in certain models.

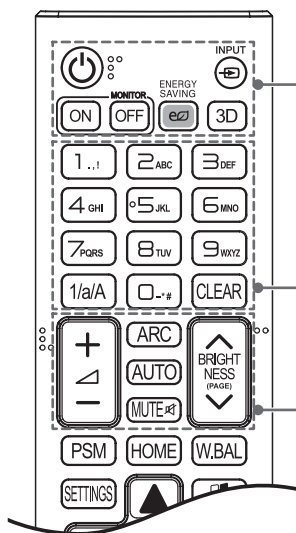

⏻ (POWER) Turns the monitor on or off.

**MONITOR ON** Turns the monitor on.

**MONITOR OFF** Turns the monitor off.

**ENERGY SAVING** Reduces power consumption by adjusting peak screen brightness.

**INPUT** Selects the input mode.

**3D** Used for viewing 3D videos.

**1/a/A** Toggles between numerical and alphabetical.

**Number and Alphabet buttons**

Enters numerical or alphabetical characters depending upon the setting.

**CLEAR** Deletes the entered numerical or alphabetical character.

**Volume Up/Down Button** Adjusts the volume.

**ARC** Selects the Aspect Ratio mode.

**AUTO** Automatically adjusts picture position and minimizes image instability (available for RGB input only).

**MUTE** Mutes all sounds.

**BRIGHTNESS (PAGE)** Adjusts the brightness of the display. PAGE Function is not supported in the this model.

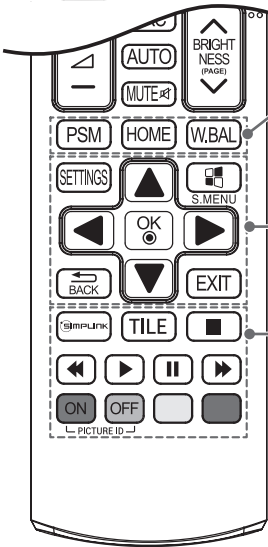

**PSM** Selects the Picture Mode.

**HOME** Activates the Launcher.

**W.BAL** Enters the White Balance menu.

**SETTINGS** Accesses the main menus or saves your input and exit menus.

**S.MENU** SuperSign menu key

**Navigation Buttons** Scrolls through menus or options.

**OK** Selects menus or options and confirms your input.

**BACK** Allows you to move back one step in the user interaction function.

**EXIT** Quit all OSD tasks and applications.

**SIMPLINK** Allows you to control various multimedia devices to enjoy multimedia simply by using the remote control through the Simplink menu.

**TILE** Selects the TILE Mode.

**PICTURE ID ON/OFF** When the Picture ID number matches the Set ID number, you can control whichever monitor you want in multi-display format.

**USB Menu Control Buttons** Controls media playback.

# MAKING CONNECTIONS

You can connect various external devices to your monitor. Change the input mode and select the external device you want to connect. For more information about external device connections, see the user manual provided with each device.

## Connecting to a PC

Some of the cables are not provided. This monitor supports the Plug and Play\* feature.

\* Plug and Play: a feature that enables a PC to recognize devices attached by the user without device configuration or user intervention when powering up.

## External Device Connection

Some of the cables are not provided. Connect an HD receiver, DVD, or VCR player to the monitor and select an appropriate input mode.

For the best picture and sound quality, connecting external devices to your monitor using HDMI cables is recommended.

**! NOTE**

- For the best image quality, using the monitor with HDMI connection is recommended.
- To comply with the standard specifications of the product, make sure to use a shielded interface cable made with a ferrite core for the DisplayPort cable and DVI-D/HDMI cable.
- If you turn the monitor on when the set is cold, the screen may flicker. This is normal.
- Sometimes red, green, or blue spots may appear on the screen. This is normal.
- Use a High Speed HDMI®/™ cable. (shorter than 3 meters (118.1 inches))
- Use a certified cable with the HDMI logo attached. If you do not use a certified HDMI cable, the screen may not display or a connection error may occur.
- Recommended HDMI Cable Types
  - High Speed HDMI®/™ Cable
  - High Speed HDMI®/™ Cable with Ethernet
- If you cannot hear any sound in HDMI mode please check your PC settings. Some PCs require you to manually change the default audio output to HDMI.
- If you want to use HDMI-PC mode, you must set your PC/DTV to PC mode.
- You may experience compatibility issues if you use HDMI-PC mode.
- Make sure the power cable is disconnected.
- If you connect a gaming device to the monitor, use the cable provided with the gaming device.

**! CAUTION**

- Connect the signal input cable and tighten it by turning the screws clockwise.
- Do not press the screen with your finger for a prolonged period as this may result in temporary distortion on the screen.
- Avoid displaying static images on the screen for a long period of time to prevent image burn. Use a screensaver if possible.
- A wireless communication device near your monitor can affect the image.

## Connecting Multiple Monitors

To use multiple monitors connected to each other, connect the end of the signal input cable (DP cable) to the DP OUT connection in one monitor and connect the other end to the DP IN connection of the other monitor.

\* DP Cable: Use a DP cable that is certified to a DP 1.1a (SST) standard or higher.

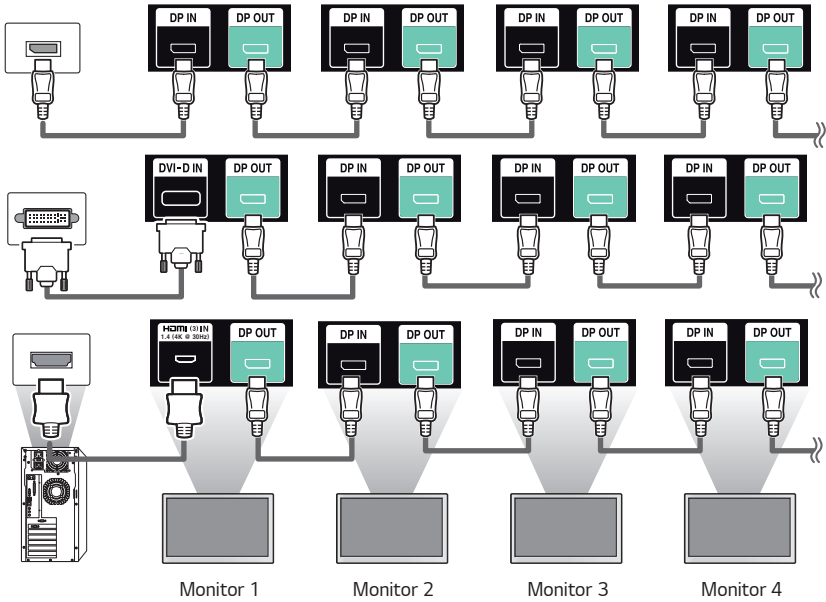

### ! NOTE

- In general, up to 100 monitors can be connected via the DP OUT port (at the recommended resolution) if the signal is stable and there is no signal loss. To connect more than 100 monitors, it is recommended to use a distributor.
- When the tile mode is configured via HDMI3/DVI-D/OPS cables, HDCP-encrypted content cannot be displayed.
- If the signal cable connecting the product to your PC is too long, make sure to use a booster or optical cable.
- HDMI1/2 inputs do not support daisy chaining monitors.

## Using the Input List

HOME → 

- HDMI1 → HDMI2 → OPS/HDMI3/DVI-D → DISPLAYPORT

# TROUBLESHOOTING

## No image is displayed.

Problem	Action
Is the product power cord connected?	<ul style="list-style-type: none"> <li>Check if the power cord is correctly plugged into the power outlet.</li> </ul>
Does an "Invalid Format" message appear?	<ul style="list-style-type: none"> <li>The signal from the PC (graphics card) is out of the vertical or horizontal frequency range of the product. Adjust the frequency range by referring to the Specifications in this manual.</li> </ul>
Does an "No Signal" message appear?	<ul style="list-style-type: none"> <li>The signal cable between PC and product is not connected. Check the signal cable.</li> <li>Press the INPUT menu in the remote control to check the input signal.</li> </ul>

## The Unknown Product message appears when the product is connected.

Problem	Action
Did you install the driver?	<ul style="list-style-type: none"> <li>Check if the Plug and Play function is supported by referring to the graphics card user manual.</li> </ul>

## The screen image looks abnormal.

Problem	Action
Is the screen position wrong?	<ul style="list-style-type: none"> <li>Check if the graphics card resolution and frequency are supported by the product. If the frequency is out of range, set to the recommended resolution in the Control Panel Display Setting menu.</li> </ul>
The screen is displayed abnormally.	<ul style="list-style-type: none"> <li>The proper input signal is not connected to the signal port. Connect the signal cable that matches with the source input signal.</li> </ul>
The PC BIOS configuration screen is not displayed correctly.	<ul style="list-style-type: none"> <li>On some PCs, the BIOS configuration screen may not display correctly because the 58:9 aspect ratio is not supported before the graphics card driver is configured. This is not a problem of the product; it is due to the design of the graphics card's BIOS configuration screen aspect ratio. To access the PC BIOS configuration screen, please connect a standard aspect ratio (4:3 or 16:9) monitor, then perform the BIOS configuration.</li> </ul>

## After-image appears on the product.

Problem	Action
After-image appears when the product is turned off.	<ul style="list-style-type: none"> <li>If you use a fixed image for a long time, the pixels may be damaged. Use the screen-saver function.</li> <li>When a dark image is displayed on the screen after an image with high contrast (black and white or gray), this may cause image sticking. This is normal for LCD screen products.</li> </ul>

**The audio function does not work.**

Problem	Action
No sound?	<ul style="list-style-type: none"> <li>• See if the audio cable is connected properly.</li> <li>• Adjust the volume.</li> <li>• See if the sound is set properly.</li> </ul>
Sound is too dull.	<ul style="list-style-type: none"> <li>• Select the appropriate equalizer sound.</li> </ul>
Sound is too low.	<ul style="list-style-type: none"> <li>• Adjust the volume.</li> </ul>

**Screen color is abnormal.**

Problem	Action
Screen has poor color resolution (16 colors).	<ul style="list-style-type: none"> <li>• Set the number of colors to more than 24 bits (true color). Select Control Panel - Display - Settings - Color Table menu in Windows.</li> </ul>
Screen color is unstable or mono-colored.	<ul style="list-style-type: none"> <li>• Check the connection status of the signal cable. Or, re-insert the PC graphics card.</li> </ul>
Do black spots appear on the screen?	<ul style="list-style-type: none"> <li>• Several pixels (red, green, white, or black color) may appear on the screen, which can be attributable to the unique characteristics of the LCD panel. This is not a malfunction of the LCD.</li> </ul>

**The operation does not work normally.**

Problem	Action
The power suddenly turned off.	<ul style="list-style-type: none"> <li>• Is the <b>Timer</b> set?</li> <li>• Check the power control settings. Power interrupted.</li> </ul>

## ! CAUTION

- Image sticking does not occur when using constantly changing images but may occur when using a fixed image for an extended period of time. Therefore, it is recommended that you use the instructions below to decrease the likelihood of image sticking occurring when using a fixed image. It is recommended that you change the screen at least once every **12 hours** at the very minimum; if done more frequently, the prevention of image sticking is more effective.

### Recommended operating conditions

- 1 Change the background and the character colors using the same time interval.



When changing colors, using complementary colors helps to prevent image sticking.

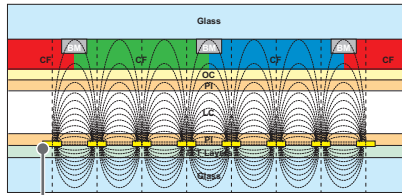

ITO or MoTi Pixel Layer

- 2 Change the image using the same time interval.

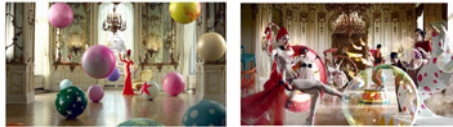

Make sure that the characters or images before changing the image remain in the same location after changing the image.

### What is image sticking?

When the LCD panel displays a static image for an extended period of time, it can cause a voltage difference between the electrodes that operate the liquid crystals. When the voltage difference between the electrodes builds up over time, liquid crystals have a tendency to remain aligned in one direction. During this process, a previously displayed image remains visible. This phenomenon is referred to as image sticking.

# PRODUCT SPECIFICATIONS

The product specifications below may be changed without prior notice due to upgrade of product functions.

LCD screen	Screen type	Thin Film Transistor (TFT) Liquid Crystal Display (LCD) Screen
Video signal	Maximum resolution	HDMI1 / HDMI2: 3840 x 2160 @ 60 Hz HDMI3 / DisplayPort: 3840 x 2160 @ 30 Hz OPS: 3840 x 600 @ 60 Hz DVI-D: 1920 x 1080 @ 60 Hz - This may not be supported on some OS or graphic card types.
	Recommended resolution	HDMI1,2,3 / DisplayPort / OPS: 3840 x 600 @ 60 Hz DVI-D: 1920 x 300 @ 59 Hz - This may not be supported on some OS or graphic card types.
	Horizontal frequency	HDMI / DVI-D / DisplayPort / OPS: 28.1 kHz to 136 kHz
	Vertical frequency	HDMI / DVI-D / DisplayPort / OPS: 50 Hz to 62 Hz
	Synchronization	Separate Sync, Digital
Input / Output ports		SD, USB 2.0 IN, USB 3.0 IN, LAN IN/OUT, DP IN/OUT, DVI-D IN, IR&LIGHT SENSOR, PIXEL SENSOR, HDMI(1) IN, HDMI(2) IN, HDMI(3) IN, RS-232C IN/OUT, AUDIO IN/OUT
Embedded battery		Applied
Environmental Conditions	Operating Temperature	0 °C to 40 °C (32 °F to 104 °F)
	Operating Humidity	10 % to 80 %
	Storage Temperature	-20 °C to 60 °C (-4 °F to 140 °F)
	Storage Humidity	5 % to 85 %
Audio	Input Sensitivity	0.7 Vrms

" ~ " refers to alternating current (AC), and " = " refers to direct current (DC).

<b>86BH5C</b>		
LCD screen	Pixel pitch	0.5595 mm (H) x 0.5595 mm (V)
Power	Rated power	AC 100-240 V~ 50/60 Hz 2.4 A
	Power consumption	On Mode: 180 W (Typ.) Sleep Mode (DVI-D, HDMI1/2/3): ≤ 30 W Sleep Mode (DisplayPort): ≤ 1.0 W Off Mode: ≤ 0.5 W
Dimensions (Width x Height x Depth) / Weight	Head	2158.3 mm x 348.5 mm x 81.7 mm / 20.5 kg (84.9 inches x 13.7 inches x 3.2 inches / 45.1 lbs)

<b>86BH7C</b>		
LCD screen	Pixel pitch	0.5595 mm (H) x 0.5595 mm (V)
Power	Rated power	AC 100-240 V~ 50/60 Hz 2.7 A
	Power consumption	On Mode: 215 W (Typ.) Sleep Mode (DVI-D, HDMI1/2/3): ≤ 30 W Sleep Mode (DisplayPort): ≤ 1.0 W Off Mode: ≤ 0.5 W
Dimensions (Width x Height x Depth) / Weight	Head	2158.3 mm x 348.5 mm x 81.7 mm / 20.5 kg (84.9 inches x 13.7 inches x 3.2 inches / 45.1 lbs)

**HDMI1,2,3 / DVI-D / DisplayPort / OPS (PC) Support Mode**

Resolution	Horizontal frequency (kHz)	Vertical frequency (Hz)	Remark
800 x 600	37.879	60.317	
1024 x 768	48.363	60	
1280 x 720	44.772	59.855	
1280 x 1024	63.981	60.02	
1920 x 1080	67.5	60	
1920 x 300	18.750	58.777	DVI-D
3840 x 600	37.398	59.933	HDMI1,2,3 / DisplayPort / OPS

**HDMI1,2,3 / DisplayPort (DTV) Support Mode**

Resolution	Horizontal frequency (kHz)	Vertical frequency (Hz)	Remark
480/60p	31.5	60	
576/50p	31.25	50	
720/50p	37.5	50	
720/60p	45	60	
1080/50i	28.1	50	
1080/60i	33.75	60	
1080/50p	56.25	50	
1080/60p	67.432	59.94	
1080/60p	67.5	60	
2160/30p	67.5	30	HDMI1,2,3 / DisplayPort
2160/50p	112.5	50	HDMI1,2
2160/60p	135	60	HDMI1,2

**Multi-screen (PC) Support Mode**

Resolution	Horizontal frequency (kHz)	Vertical frequency (Hz)	Remark
1920 x 1080	67.5	60	
1920 x 600	37.4	59.93	Recommended resolution for two-screen split screen
1280 x 600	37.35	59.85	Recommended resolution for three-screen split screen
960 x 600	37.4	59.93	Recommended resolution for four-screen split screen

**Multi-screen (DTV) Support Mode**

Resolution	Horizontal frequency (kHz)	Vertical frequency (Hz)	Remark
1080/60p	67.432	59.94	HDTV 1080P 60Hz
1080/50p	56.25	50	HDTV 1080P 50Hz
720/60p	45	60	HDTV 720P
720/50p	37.5	50	HDTV 720P

**! NOTE**

- PC resolutions available for the Input Label option in HDMI / DVI-D / DisplayPort input modes: 640 x 480/60 Hz, 1280 x 720/60 Hz, 1920 x 1080/60 Hz, 3840 x 2160/60Hz; 480p, 720p, 1080p and 2160p DTV resolutions.
- Vertical frequency: The product display functions by the screen image changing dozens of times every second like a fluorescent lamp. The vertical frequency or refresh rate is the number of image displays per second. The unit is Hz.
- Horizontal frequency: The horizontal interval is the time taken to display one horizontal line. When 1 is divided by the horizontal interval, the number of horizontal lines displayed every second can be tabulated as the horizontal frequency. The unit is kHz.
- For the recommended resolution of 3840 x 600, use a graphics card that is UHD (3840 x 2160) compatible.
- When using a graphics card that does not support the recommended resolution (3840 x 600), a resolution of 1920 x 300 or 1920 x 1080 can be used instead.
- Some graphics cards may not support a 3840 x 600 resolution.
- In Multi-screen mode, the resolution changes to fit the screen.



**Supplier's Declaration of Conformity**

Trade Name	LG
Responsible Party	LG Electronics USA, Inc.
Address	111 Sylvan Avenue, North Building, Englewood Cliffs, NJ 07632
E-mail	lg.environmental@lge.com

Make sure to read the Safety Precautions before using the product.

The model and serial numbers of the SET are located on the back and one side of the SET. Record it below should you ever need service.

MODEL \_\_\_\_\_

SERIAL NO. \_\_\_\_\_

**WARNING** -This equipment is compliant with Class A of CISPR 32. In a residential environment this equipment may cause radio interference.

Temporary noise is normal when powering ON or OFF this device.



USER GUIDE

# LG Digital Signage

(MONITOR SIGNAGE)

Please read this manual carefully before operating your set and retain it for future reference.

webOS 2.0

# TABLE OF CONTENTS

## USER SETTINGS ..... 3

- Main Menu Settings.....3
- Picture Settings
- Sound Settings
- Network Settings
- General Settings

## ENTERTAINMENT ..... 13

- Using My Media.....13
- Connecting USB/SD Storage Devices
- Files Supported by My Media
- Viewing Videos
- Viewing Photos
- Listening to Music
- Settings
- Moving, Copying, or Deleting a File
- SuperSign Contents.....21
- Information .....21
- Local Contents Scheduler.....22
- Screen Share .....23
- SuperSign EZ.....25
- Multi-Screen.....27
- PICTURE ID Settings.....29

## IR CODES ..... 30

## TO CONTROL MULTIPLE PRODUCTS..... 32

- Connecting the Cable.....32
- Communication Parameter .....33
- Command Reference List .....34
- Transmission/Reception Protocol .....37

To obtain the source code under GPL, LGPL, MPL, and other open source licenses, that is contained in this product, please visit <http://opensource.lge.com>.

In addition to the source code, all referred license terms, warranty disclaimers and copyright notices are available for download. LG Electronics will also provide open source code to you on CD-ROM for a charge covering the cost of performing such distribution (such as the cost of media, shipping, and handling) upon email request to [opensource@lge.com](mailto:opensource@lge.com). This offer is valid for three (3) years from the date on which you purchased the product.

## ! NOTE

- The software-related contents may be changed without prior notice due to upgrade of the product functions.
- Some features described in the Installation manual may not be supported in certain models.
- SNMP 2.0 is supported.

# User Settings

## Main Menu Settings

### Picture Settings

#### To Select Picture Mode

SETTINGS → Advanced → Picture → Picture Mode Settings → Picture Mode

Select the picture mode that is best suited to the video type.

- **Vivid:** adjusts the video image for a retail environment by enhancing the **contrast, brightness,** and **sharpness.**
- **Standard:** adjusts the video image for a normal environment.
- **APS:** APS (Auto power saving ) mode reduces power consumption by dimming control.
- **Cinema:** optimizes the video image for watching movies.
- **Sports:** optimizes the video image for watching sports. Even fast actions such as kicking or throwing a ball are rendered clearly on the screen.
- **Game:** optimizes the video image for playing videogames.
- **Photo:** Optimizes the screen for viewing photos. (This feature is available only with certain models.)
- **Expert/Calibration:** allows an expert, or anyone interested in high quality pictures, to manually tune the picture for the best picture quality.

## ! NOTE

- Depending on the input signal, the available **Picture Modes** may differ.
- **Expert** is an option that allows a picture quality expert to fine-tune the picture quality using a specific image. Thus, it may not be effective for a normal picture.

## To fine-tune the picture mode

### SETTINGS → Advanced → Picture → Picture Mode Settings → Customize

- **Backlight:** adjusts the brightness of the screen by controlling the LCD backlight. The closer the value is to 100, the brighter the screen is.
- **Contrast:** adjusts the difference between the light and dark areas of the picture. The closer the value is to 100, the greater the difference is.
- **Brightness:** adjusts the overall brightness of the screen. The closer the value is to 100, the brighter the screen is.
- **Sharpness:** adjusts the sharpness of the edges of objects. The closer the value is 50, the clearer and the sharper the edge becomes.
- **H Sharpness:** adjusts the sharpness of the contrast edges on the screen from a horizontal point of view.
- **V Sharpness:** adjusts the sharpness of the contrast edges on the screen from a vertical point of view.
- **Color:** softens or deepens the tints on the screen. The closer the value is 100, the deeper the colors become.
- **Tint:** adjusts the balance between red and green levels displayed on the screen. The closer the value is to Red 50, the deeper the color red becomes, and the closer the value is to Green 50, the deeper the color green becomes.
- **Color Temperature:** adjusts the tints of the screen to evoke feelings of warmth or coolness.
- **Advanced Controls/Expert Control:** customizes the advanced options.
  - **Dynamic Contrast:** Optimizes the difference between the light and dark parts of the screen according to the brightness of the image.
  - **Super Resolution:** Sharpens the blurry or indistinguishable parts of the picture.
  - **Color Gamut:** Selects the range of colors to display.
  - **Dynamic Color:** Adjusts the tint and saturation of the image for a more vivid and lively display.
  - **Edge Enhancer:** Provides much sharper and clearer edges to the picture.
  - **Color Filter:** Accurately adjusts color and tint by filtering a specific color area of RGB space.
  - **Preferred Color:** Adjusts the skin tint, grass tint, and sky tint to your preference.
  - **Gamma:** Adjusts the medium brightness of the image.
  - **White Balance:** Adjusts the overall tint of the picture to your preference. In Expert mode, you can fine-tune the picture using the Method/Pattern options.
  - **Color Management System:** Experts use the color management system when they adjust the colors by using the test pattern. The color management system allows you to make an adjustment by selecting from among 6 different color spaces (Red/Yellow/Blue/Cyan/Magenta/Green) without affecting other colors. You may not see tints change in a normal picture even after adjustment.

- **Picture Options:** customizes the picture options.
  - **Noise Reduction:** Removes irregularly generated tiny dots for a clear picture.
  - **MPEG Noise Reduction:** Reduces the noise produced while creating digital video signals.
  - **Black Level:** Adjusts the black level of the picture to correct the brightness and contrast of the picture.
  - **Real Cinema:** Optimizes the video image for a cinematic look.
  - **TruMotion:** Reduces image shaking and image sticking that can occur with moving images.
- **Reset:** resets the picture settings.

## NOTE

- You can adjust advanced settings only in the **User** mode.
- Depending upon the input signal or the selected picture mode, the available options may differ.

### To set the aspect ratio,

(Some features may not be supported in certain models.)

#### SETTINGS → Advanced → Picture → Aspect Ratio

Changes the aspect ratio to view the image in its optimal size.

- **16:9:** displays the image with a 16:9 aspect ratio.
- **Just Scan:** displays the image in the original size without cutting off the edges.  
Original is available in HDMI (720p or higher) mode. (On 58:9 models, this option can be selected regardless of the input signal.)
- **Set By Program:** automatically changes the aspect ratio to 4:3 or 16:9 depending on the input video signal.
- **4:3:** displays the image with a 4:3 aspect ratio.
- **Zoom:** expands the image to fit to the width of the screen. The top and bottom of the image may be cropped.
- **Cinema Zoom:** enlarges the image to have a cinemascope ratio of 2.35:1 without distortion.
- **58:9:** Displays the screen with a 58:9 aspect ratio.

## CAUTION

- If a fixed image is displayed on the screen for a long period of time, it will be imprinted and become a permanent disfigurement on the screen. This image burn or burn-in is not covered by the warranty.
- If the aspect ratio is set to **4:3** for a long period of time, image burn may occur on the letterboxed area of the screen.
- The options may differ depending on the model.
- Depending on the input signal, the available aspect ratio may differ.
- You can select only **4:3** and **16:9** aspect ratios in HDMI-PC/ DVI-D/ DISPLAYPORT-PC/ OPS-PC/ RGB input mode. (This does not apply to 58:9 models.)
- When you adjust **Zoom** or **Cinema Zoom**, the screen may flicker for some input signals.

### To use the Energy Saving function

#### SETTINGS → Advanced → Picture → Energy Saving

Reduces power consumption by adjusting peak screen brightness.

- **Auto:** adjusts the brightness of the monitor according to ambient light. (This feature is available only with certain models.)
- **Off:** disables the Energy Saving mode.
- **Minimum/Medium/Maximum:** uses the Energy Saving according to the Energy Saving level specified for your monitor.
- **Screen Off:** turns off the screen. You will only hear audio. You can turn on the screen again by pressing any button on the remote control except the power button.

### To use the Smart Energy Saving function

#### SETTINGS → Advanced → Picture → Smart Energy Saving

According to picture brightness, the brightness of the monitor will be adjusted automatically to save energy.

- **Off:** disables the Smart Energy Saving function.
- **On:** enables the Smart Energy Saving function.

### To use the SCREEN(RGB-PC) function

(Only applies to certain models.)

#### SETTINGS → Advanced → Picture → SCREEN(RGB-PC)

Customizes the PC display options in RGB mode.

- **Set Automatically:** Sets to adjust the screen position, clock, and phase automatically.  
The displayed image may be unstable for a few seconds while the configuration is in progress.
- **Resolution:** Selects a proper resolution.
- **Position/Size/Phase:** Adjusts the options when the picture is not clear, especially when characters are shaky, after the auto configuration.
- **Reset:** Restores the options to the default setting.

### To run a Picture Test

(Only applies to certain models.)

#### SETTINGS → Advanced → Picture → Picture Test

Run a Picture Test to check that picture signals are outputted normally, then solve any problems by selecting the relevant option on the screen. If there are no problems with the Test Picture, check connected external devices.

### How to Use HDMI ULTRA HD Deep Colour

[For Ultra HD models only]

#### SETTINGS → Advanced → Picture → HDMI ULTRA HD Deep Colour

If you connect an HDMI device to one of the Deep Colour adjustable ports, you can select Deep Colour On (6G) or Off (3G) in the HDMI ULTRA HD Deep Colour settings menu.

If a compatibility issue occurs with a graphics card when the Deep Colour option is set to On at 3840 x 2160 @ 60 Hz, set the Deep Colour option to Off.

- HDMI specifications may vary depending on the input port. Check the specifications of each device before connecting.
- HDMI input port 1,2 are best suited for 4K at 60 Hz (4:4:4, 4:2:2) to enjoy high definition video. However, video or audio may not be supported depending on the specifications of the external devices. In that case, please connect to another HDMI port.

## Sound Settings

- Only applies to certain models.

### To select a Sound Mode

#### SETTINGS → Advanced → Sound → Sound Mode

The best sound quality will be selected automatically depending on the video type currently being watched.

- **Standard:** this sound mode works well for content of all types.
- **Cinema:** optimizes sound for watching movies.
- **News:** optimizes sound for watching news.
- **Sports:** optimizes sound for watching sports.
- **Music:** optimizes sound for listening to music.
- **Game:** optimizes sound for playing videogames.

### To use the Sound Effects function

#### SETTINGS → Advanced → Sound → Sound Effects

- **Clear Voice II:** enjoy clearer sound with the three-level adjustment.
- **Equalizer:** manually adjust sound by using the equalizer.
- **Balance:** adjust the output volume for the left speaker and the right speaker.
- **Reset:** reset the sound settings.

### To select a Volume Increase Rate,

#### SETTINGS → Advanced → Sound → Volume Increase Amount

you can set the volume range by selecting any of **Low/ Medium/ High**.

### To sync audio with video

#### SETTINGS → Advanced → Sound → AV Sync Adjustment

- **Speaker:** adjusts the sync between video and audio coming from external speakers, such as those connected to the digital audio output port, LG audio equipment, or headphones. From the default value, the closer the value is to -, the faster the sound output becomes, and the closer the value is to +, the slower the sound output becomes.
- **Bypass:** audio coming from external devices without delay. Audio may be outputted earlier than video due to the processing time for video that is inputted into the monitor.

### To Run a sound test

#### SETTINGS → Advanced → Sound → Sound Test

Run a sound test to check that sound signals are outputted normally, then solve any problems by selecting the relevant option on the screen. If there are no problems with the Sound Test, check connected external devices.

## Network Settings

### To Set a Signage Monitor Name

#### SETTINGS → Advanced → Network → Signage Name

You can set a name for Signage Monitor that will be used on the network by using the on-screen keyboard.

### To Set Your Wired Network

#### SETTINGS → Advanced → Network → Wired Connection (Ethernet)

- **Connecting to a wired network:** Connect your monitor to a local area network (LAN) via the LAN port, and configure the network settings. Only wired network connections are supported. After making a physical connection, a small number of networks may require the display network settings to be adjusted. For most networks, the display will automatically make a connection without any adjustments. For detailed information, contact your Internet provider or consult your router manual.

### Setting a Wireless Network

#### SETTINGS → Advanced → Network → Wi-Fi Connection

If you have set the monitor up for a wireless network, you can check and connect to the available wireless Internet networks.

- **Add a Hidden Wireless Network:** If you input the name of network directly, you can add a wireless network.
- **Connect via PBC:** Connects easily when the button of a wireless AP supporting PBC is pressed.
- **Connect via PIN:** Connects easily when the PIN of the wireless AP that you wish to connect to is entered in to the AP configuration webpage.
- **Advanced Settings:** If you input the information of network directly, you can enter a wireless network. If there is no wireless network available, click **Advanced Settings**. You can add a network.

### Setting up a SoftAP

#### SETTINGS → Advanced → Network → SoftAP

If you set up a SoftAP, you can connect many devices via a Wi-Fi connection without a wireless router and use wireless Internet.

- To use SIGNAGE, you must have an Internet connection.
- You cannot use the SoftAP feature and the Screen Share feature at the same time.
- On models that support Wi-Fi dongles, the SoftAP menu is enabled only when a Wi-Fi dongle is connected to the product.
- SoftAP connection information
  - SSID: A unique identifier necessary to make a wireless Internet connection
  - Security key: The security key you enter to connect to the desired wireless network
  - Number of connected devices: Shows the number of devices currently connected to your Signage device via a Wi-Fi connection. Up to 10 devices are supported.

### Tips for Network Setting

- Use a standard LAN cable (Cat5 or higher with a RJ45 connector) with this display.
- Many network connection problems during set-up can often be fixed by re-setting the router or modem. After connecting the display to the home network, quickly power off and/or disconnect the power cable of the home network router or cable modem, then power on and/or connect the power cable again.
- Depending on the Internet Service Provider (ISP), the number of devices that can receive Internet service may be limited by the applicable terms of service. For details, contact your ISP.
- LG is not responsible for any malfunction of the display and/or the Internet connection feature due to communication errors/malfunctions associated with your Internet connection, or other connected equipment.
- LG is not responsible for problems with your Internet connection.
- You may experience undesired results if the network connection speed does not meet the requirements of the content being accessed.
- Some Internet connection operations may not be possible due to certain restrictions set by the Internet Service Provider (ISP) supplying your Internet connection.
- Any fees charged by an ISP including, without limitation, connection charges are your responsibility.

### ! NOTE

- If you want to access the Internet directly on your display, the Internet connection should always be on.
- If you cannot access the Internet, check the network conditions from a PC on your network.
- When you use Network Setting, check the LAN cable or check if DHCP in the router is turned on.
- If you do not complete the network settings, the network may not function correctly.

### ! CAUTION

- Do not connect a modular telephone cable to the LAN port.
- Since there are various connection methods, please follow the specifications of your telecommunication carrier or Internet Service Provider.
- Network Setting menu will not be available until the display is connected to a physical network.

### Tips for Wireless Network Setting

- Wireless networks can be subject to interference from other devices operating at a frequency of 2.4 GHz (wireless phones, Bluetooth devices or microwave ovens). There may also be interference from devices with a frequency of 5 GHz, same as other Wi-Fi devices.
- The surrounding wireless environment can cause the wireless network service to run slowly.
- If you do not turn off the entire local home network, network traffic may occur on some devices.
- For an AP connection, an access point device that supports wireless connection is required and the wireless connection feature must be enabled on the device. Contact your service provider regarding availability of wireless connection on your access point.
- Check the SSID and security settings of the AP for AP connection. Refer to the appropriate documentation for SSID and security settings of the AP.
- Invalid settings on network devices (wired/wireless line sharer, hub) can cause the monitor to run slowly or not operate properly. Install the devices correctly according to the appropriate manual and set the network.
- Connection method may differ according to the AP manufacturer.

## General Settings

### To configure the language

#### SETTINGS → Advanced → General → Menu Language

Select one of the languages on the menu displayed on the screen.

- **Menu Language:** sets a language for Signage.

### Setting up the keyboard language

#### SETTINGS → Advanced → General → Keyboard Languages

Select the language you wish to show on the keyboard.

- **Keyboard Languages:** Sets the keyboard language.

### To set the time/date

#### SETTINGS → Advanced → General → Time & Date

You can check or change the time.

- **Set Automatically :** You can set Time and Date.
- **Daylight Saving Time:** You can set Start Time and End Time for Daylight Saving Time. The DST start/end settings work only when you set them more than one day apart from each other.
- **Time zone:** You can change the settings for Continent, Country/Territory, and City.

### To turn your monitor on or off automatically

#### SETTINGS → Advanced → General → Timers

You can set the On/Off Timer for your monitor.

- **On Timer:** you can set the time when your monitor turns on.
- **Off Timer:** you can set the time when your monitor turns off.
- **No Signal Power Off (15Min):** When there is no input source, the monitor will automatically turn off after 15 minutes. If you don't want it to turn off automatically, set No Signal Power Off to **Off**.
- **Auto Power Off:** When there is no key input, the monitor will automatically turn off.

### NOTE

- On Time/Off Time can be saved for up to seven schedules; the monitor is turned on or off at the preset time in the schedule list. If multiple preset times are stored in the schedule list, this function works at the nearest time from the current time.
- Once the on or off time is set, these functions operate daily at the preset time.
- The scheduled power-off function works properly only when the device time is set correctly.
- When the scheduled power-on and power-off times are the same, the power-off time has priority over the power-on time if the set is turned on, and vice versa if the set is turned off.

**To reset your monitor settings****SETTINGS → Advanced → General → Reset to Initial Settings**

Resets all monitor settings.

# ENTERTAINMENT

## Using My Media

### Connecting USB/SD Storage Devices

Connect a USB storage device such as a USB flash memory, SD storage devices or an external hard drive to the display and use multimedia features.



#### CAUTION

- Do not turn off the monitor or remove a USB storage device when the **My Media** screen is activated. This could result in loss of files or damage to the USB storage device.
- Back up files you have saved on a USB storage device frequently, as loss or damage to the files may be not covered by the warranty.

### Tips for using USB/SD storage devices

- Only a USB storage device can be recognized.
- A USB device does not work effectively when it is connected via a USB hub.
- A USB storage device using an automatic recognition program may not be recognized.
- A USB storage device using its own driver may not be recognized.
- The recognition speed of a USB storage device may depend on each device.
- Please do not turn off the display or unplug the USB storage device when the connected device is working. If the USB storage device is suddenly disconnected, the stored files or the device itself may be damaged.
- Please do not connect a USB storage device which was modified to work on a PC. The device may cause the monitor to malfunction or the content fail to be played. Use only a USB storage device which contains normal music, image or video files.
- A USB storage device formatted as a utility program not supported by Windows may not be recognized.
- A USB storage device (over 0.5 A) which requires an external power supply must be connected to a power supply separately. If it is not, the device may not be recognized.
- Please connect the USB storage device using the cable provided by the device manufacturer.
- Some USB storage devices may not be supported or operate smoothly.
- File alignment method of USB storage devices is similar to that of Window XP and filenames can recognize up to 100 English characters.
- Back up important files regularly as data stored on a USB storage device may be damaged. We will not be responsible for any data loss.
- If the USB HDD does not have an external power source, the USB device may not be detected. To ensure the device is detected, connect the external power source.
  - Please use a power adapter for an external power source. We do not provide a USB cable for an external power source.
- If your USB storage device has multiple partitions, or if you use a USB multi-card reader, you can use up to four partitions or USB storage devices.
- If a USB storage device is connected to a USB multi-card reader, its volume data may not be detected.
- If the USB storage device does not work properly, disconnect and reconnect it.
- Detection speed differs from device to device.
- If the USB storage device is connected in Standby Mode, the specific hard disk will automatically be loaded when the display is turned on.
- The recommended capacity is 1 TB or less for a USB external hard drive and 32 GB or less for USB memory stick.
- Any device with more than the recommended capacity may not work properly.
- If a USB external hard drive with an "Energy Saving" function does not work, try turning the hard drive off and on again.
- USB storage devices below USB 2.0 are also supported but may not function correctly in the Videos.
- A maximum of 999 sub-folders or files can be recognized under one folder.
- The SDHC type for SD cards is supported. To use an SDXC card, format it to the NTFS file system first.
- The exFAT file system is not supported for SD cards and USB storage devices.

## Files Supported by My Media

### Supported External Subtitle Format

(Subtitles are not supported in certain models.)

- \*.smi, \*.srt, \*.sub (MicroDVD, SubViewer 1.0/2.0), \*.ass, \*.ssa, \*.txt (TMPlayer), \*.psb (PowerDivX), \*.dcs (DLP Cinema)

### To use Select Play

HOME →  → Photos/ Videos/ Music/ All → 

- **Play Selection:** plays back selected content.

### To set FILTER

HOME →  → Photos/ Videos/ Music/ All → 

- **FILTER:** import contents from the selected device.

### To set Scheduled Playing

HOME →  → Photos/ Videos/ Music/ All → 

- **Scheduled Playing:** You can play the selected content at the scheduled time.

### Supported Internal Subtitle Format

- FULL HD Video  
1920 x 1080: XSUB (Supports internal subtitles generated from DivX6)
- [For Ultra HD models only] Ultra HD image: Does not support internal subtitles.

### Supported Video Codec

Extension	Codec	
.asf .wmv	Videos	VC-1 Simple and Main Profiles
	Audio	WMA Standard, WMA 10 Professional
.divx .avi	Videos	DivX3.11, DivX4, DivX5, DivX6, XVID, H.264/AVC, Motion Jpeg, MPEG-4 Part2
	Audio	MPEG-1 Layer I, II, MPEG-1 Layer III (MP3), Dolby Digital, LPCM, ADPCM, DTS
.mp4 .m4v .mov	Videos	H.264/AVC, MPEG-4 Part2
	Audio	AAC, MPEG-1 Layer III (MP3)
.3gp .3g2	Videos	H.264/AVC, MPEG-4 Part2
	Audio	AAC, AMR-NB, AMR-WB
.mkv	Videos	H.264/AVC
	Audio	HE-AAC, Dolby Digital
.ts .trp .tp .mts .m2ts	Videos	H.264/AVC, MPEG-2
	Audio	MPEG-1 Layer I, II, MPEG-1 Layer III (MP3), Dolby Digital, Dolby Digital Plus, AAC, PCM
.mpg .mpeg	Videos	MPEG-1, MPEG-2
	Audio	MPEG-1 Layer I, II, MPEG-1 Layer III (MP3), AAC
.vob	Videos	MPEG-1, MPEG-2
	Audio	Dolby Digital, MPEG-1 Layer I, II, DVD-LPCM

### Supported Audio File

File Format	Item	Information
.MP3	Bit rate	32 Kbps to 320 Kbps
	Sample freq.	16 KHz to 48 KHz
	Support	MPEG1, MPEG2, Layer2, Layer3
	channels	mono, stereo
.ogg	Bit rate	64 Kbps to 500 Kbps
	Sample freq.	8 kHz to 48 kHz
	Support	Vorbis
	channels	mono, stereo
.wma	Bit rate	~1.5 Mbps
	Sample freq.	8 kHz to 192 kHz
	Support	WMA
	channels	up to 6 ch

### Supported Photo File

File Format	Format	Item
.jpeg, .jpg, .jpe	JPEG	<ul style="list-style-type: none"> <li>• Minimum : 64 x 64</li> <li>• Maximum               <ul style="list-style-type: none"> <li>- Normal Type: 15360 (W) x 8640 (H)</li> <li>- Progressive Type: 1920 (W) x 1440 (H)</li> </ul> </li> </ul>
.png	PNG	<ul style="list-style-type: none"> <li>• Minimum : 64 x 64</li> <li>• Maximum: 5760 (W) x 5760 (H)</li> </ul>
.bmp	BMP	<ul style="list-style-type: none"> <li>• Minimum : 64 x 64</li> <li>• Maximum: 1920 (W) x 1080 (H)</li> </ul>

### Supported Files and Formats for Content (with SuperSign Manager)

File extension	*.cts, *.sce
Video file extension	*.mpg, *.mpeg, *.dat, *.ts, *.trp, *.tp, *.mp4, *.mkv, *.avi, *.avi(motion JPEG), *.mp4(motion JPEG), *.mkv(motion JPEG)
Video format	MPEG1, MPEG2, MPEG4,H.264, DivX 3.11, DivX 4, DivX 5, DivX 6, Xvid 1.00, Xvid 1.01, Xvid 1.02, Xvid 1.03, Xvid 1.10-beta1/2, Motion JPEG
Audio format	MP3, Dolby Digital, LPCM, AAC, HE-AAC, AMR-NB, AMR-WB
Web page	Only web pages that support iframe can be displayed.

## Viewing Videos

Play video files on display. All of the saved video files are shown in your display.

### To play video files on display

HOME →  → Videos

### Tips for Playing Video Files

- Some user-created subtitles may not work properly.
- Some special characters in subtitles are not rendered.
- HTML tags are not supported in subtitles.
- Subtitles in languages other than the supported languages are not available.
- The screen may suffer temporary interruptions (image stoppage, faster playback, etc.) when the audio language is changed.
- A damaged video file may not play correctly, or some player functions may not be usable.
- Video files produced with some encoders may not be played correctly.
- If the video and audio structure of a recorded file is not interleaved, either video or audio is outputted.
- Video files other than the specified types and formats may not play correctly.
- Maximum bit rate of playable video file is 20 Mbps. (Motion JPEG: 10 Mbps only)
- We cannot guarantee smooth playback of files encoded level 4.1 or higher in H.264 / AVC.
- Video files more than 30 GB in file size are not supported.
- A DivX video file and its subtitle file must be located in the same folder.
- A video file and its subtitle file must be located in the same folder. A video file name and its subtitle file name must be identical in order to display the subtitle properly.
- Playing a video via a USB connection that does not support high-speed connection may not function correctly.
- Subtitles on a Network Attached Storage (NAS) device may not be supported depending on the manufacturer and model.
- Streaming of files encoded by GMC (Global Motion Compensation) or Qpel (Quarterpel Motion Estimation) is not supported.
- [For Ultra HD models only] Ultra HD image: 3840 X 2160  
Some HEVC-encoded Ultra HD videos other than the content officially provided by LG Electronics may not be played. Some codecs can be used after upgrading software.

Extension	Codec	
.mkv	Video	H.264/AVC, HEVC
.mp4 .ts	Audio	Dolby Digital, Dolby Digital Plus, AAC, HE-AAC

- Playable file sizes may vary depending on the encoding condition.
- The AAC Main profile is not supported.
- Video files created by some encoders may not play.

 **NOTE**

- Option values changed in **Videos** do not affect the **Photos** and **Music**, and in turn are not affected by option values changed in **Photos** or **Music**.
- Option values changed in **Photos** and **Music** do affect each other.
- When restarting a video file after stopping it, you can play from the point at which it was stopped.
- Only 10,000 sync blocks can be supported within the subtitle file.
- When playing a video, you can adjust the picture size by pressing the **ARC** button.
- Korean subtitle is supported only when the OSD menu is in Korean.
- The code page options may be disabled depending on the language of the subtitle files.
- Select the appropriate code page for the subtitle files.

## Viewing Photos

The displays on the screen may differ from the model.

### Viewing image files









HOME →  → Photos

## Listening to Music

### Viewing music files

HOME →  → Music

### ! NOTE

- Files with unsupported extensions are not displayed.
- If a file is invalid, a broken image and the message "unrecognizable file" are displayed.
- Damaged music files are displayed as 00:00 and will not be played.
- A music file downloaded from a paid service with copyright protection will not play, and incorrect information may be displayed during playback.
- You can use , , , ,  buttons on the remote control also in this mode.
- You can use the  button to select the next track and the  button to select the previous track.
- If you press the  button within 5 seconds after playing the song, you will return to the previous song; if you press the same button after 5 seconds, you will return to the start of the song.

## Settings

You must register your product to play a DRM-protected DivX video.

### In order to register/deregister purchased or rented DivX® VOD contents

HOME →  → Videos → DivX® VOD

In order to play purchased or rented DivX® VOD contents, you should register your device with 10 digit DivX registration code from your device at [www.divx.com/vod](http://www.divx.com/vod).

- **Registration:** view the registration code of your display.
- **Deregistration:** cancel the registration.

### ! NOTE

- While you are checking the registration code, some buttons may not work.
- If you use the DivX registration code of another device, you cannot play rented or purchased DivX files. Use only the DivX registration code assigned to your product.
- Video or audio files that are not converted using the standard DivX codec may be corrupted or not play.
- The DivX® VOD code allows you to activate up to 6 devices under one account.
- After deregistration, you must register your device again to see DivX® VOD contents.

## Moving, Copying, or Deleting a File

You can move, copy, or delete files.

### To move, copy, or delete files

HOME →  → Devices

- You can move or copy files or folders from internal to external memory.
- You can move or copy files or folders from external to internal memory.
- You can delete files or folders from internal or external memory.

### ! NOTE

- Those files bigger than internal remaining memory aren't allowed to be copied or moved to the internal memory.

## SuperSign Contents

Plays stored files using the Export option in SuperSign Editor.

### To play back the stored files using the Export option

HOME → 

Only contents distributed by SuperSign Manager are displayed and selectable. If there is a USB/SD storage device connected, the image on the USB/SD device is outputted additionally.

### ! NOTE

- If there is an AutoPlay folder in the USB storage device and its files are in supported formats, they will be played back automatically when the USB storage device is connected to the monitor.

## Information

### To check the basic information of Signage Monitor

HOME → 

You can see the basic information on Signage Monitor.

You can also switch to **Smart Energy Saving Mode** or configure **Fail Over** settings. (You can switch to **Smart Energy Saving Mode** only when **Energy Saving Mode** is set to Off.)

## Local Contents Scheduler

- Only applies to certain models.

You can view or delete any scheduled playing created in **MY MEDIA**.

### To access Local Contents Scheduler

HOME → 

Go to **Local Contents Scheduler** to check the list of the scheduled playing created in **MY MEDIA**.

### ! NOTE

- By default, **Local Contents Scheduler** lists the scheduled playing created by the currently connected devices.

### To add new a scheduled playing

HOME →  → 

- **NEW SCHEDULED PLAYING:** In the pop-up window, click the **GO TO MY MEDIA** button and enter **MY MEDIA** to create new a scheduled playing.

### To configure FILTER

HOME →  → 

- **FILTER:** You can view the list by sorting it based on the type of device used for creating the scheduled playing.

### To delete a scheduled playing

HOME →  → 

- **DELETE:** You can select a scheduled playing and delete it.

### To view detailed information about a scheduled playing

HOME →  → **Select Scheduled Playing**

- From list of the scheduled playing, select a specific scheduled playing and view its detailed information.

### To play scheduled playing instantly



HOME →  → **Select Scheduled Playing → Play Button**

- In the detailed information page of the scheduled playing, click the Play button above the thumbnail to play the scheduled playing instantly.

### ! NOTE

- To play a scheduled playing instantly rather than at the scheduled time, the scheduled playing must be in a playable status. In other words, the device used for creating the scheduled playing must be connected, and all the content included in the scheduled playing must be valid.

### Editing a Scheduled Playing

HOME →  → **Select the desired scheduled Playing → **

- **EDIT:** Click the EDIT button at the top left of the Details page of your desired scheduled Playing, and then you will be directed to My Media where you can edit information about the scheduled Playing including its content and other details.

### ! NOTE

- You can edit the scheduled Playing only when the device used for creating the scheduled playback is connected.

## Screen Share

- Only applies to certain models.

Allows the screen of a user's device such as a mobile or PC Windows to be shared with a display using a wireless connection such as WiDi or Miracast.

### To use Screen Share

HOME → 

When the **Screen Share** app is running, the wireless connection such as WiDi or Miracast is automatically set to ON and the display is automatically changed to the connection ready mode. In this state, you can use **Screen Share** by turning on the wireless connection on the device and selecting the display to establish a connection between the device and the display.

### ! NOTE

## Configuring WiDi (Wireless Display)

WiDi, which is short for Wireless Display, is a system that wirelessly transmits video and sound files from a laptop that supports Intel WiDi to the display.

This is available only in certain input modes (Composite/Component/RGB/HDMI/DP/OPS/DVI-D).

Other than these modes, LG Signage cannot be detected by your PC.

- 1 Connect your laptop to an AP. (This feature can be used without an AP, but it is recommended that you connect to it for optimal performance.)  
Run the Intel WiDi  program on your laptop.
- 2 Any nearby LG Signages supporting WiDi are detected. In the list of detected displays, select a Signage to connect to and then, click Connect.  
Enter the 8-digit PIN number (a) displayed on the Signage in the input field of your laptop (b) and click Continue.

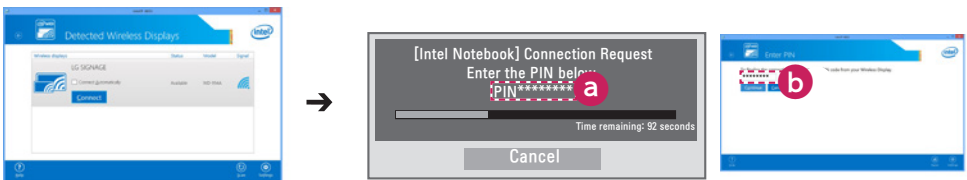

Signage screen

Laptop screen

- 3 The laptop screen appears in the Signage screen within 10 seconds. The wireless environment may affect the screen from displaying.  
If the connection is poor, the Intel WiDi connection may be lost.
  - LG Signage does not need to be registered.
  - For more information on how to use Intel WiDi, visit <http://intel.com/go/widi>.
  - This works normally with WiDi 3.5 or later versions.

**To select connection mode**

HOME →  → Listen Mode

You can select between **On** and **Off**.

If it is set to **On**, even when the app is not running, you can turn on a wireless connection feature such as WiDi or Miracast and select a display to connect the device and display. Then, **Screen Share** will be available for use.

**! NOTE**

- If the **Screen Share** app has been deleted from the HOME screen, **Screen Share** cannot be used even if **Listen Mode** is set to **On**.

**To set the transfer speed**

HOME →  → Transfer Speed

Transfer speed can be set to **Fast** or **Normal**. When **Screen Share** is running, this option adjusts the time difference of the image output between the device and the display. Adjusting the transfer speed can repair any interruptions in displays when mirroring is used.

## SuperSign EZ

- Only applies to certain models.

**SuperSign EZ** enables you to produce and play Signage content. This feature enables you to edit Signage content based on templates and set its playback time. In addition, this feature also enables you to access **SuperSign EZ** from your mobile device or PC and create/edit content.



### CAUTION

- A maximum of 5,000 images stored on a USB drive/SD card can be displayed from your PC or mobile device. Images more than 5,000 cannot be displayed from your PC or mobile device. In addition, we recommend you store no more than 1,000 images for use on your USB drive or SD card. If you use more than 1,000 images, the images may not be displayed smoothly depending on your environment.
- Supported devices (Some features may not be available depending on the type or version of your device or browser.)
  - Android 4.4 or later (Chromium v.38.0)
  - iOS 8 or later (Safari v.600.1.4 or later)
  - PC: Chromium v.38.0
- Supported resolutions (this program is optimized for the following resolutions):
  - 360 x 640, 600 x 960, 375 x 667, 768 x 1024 and 1920 x 1080
- Content playback time: The minimum playback time is set to 5 seconds. If you set the content playback time to less than 5 seconds, it is automatically reset to 5 seconds.
- If you play UHD videos on a UHD model, videos with a high bitrate may not play properly due to the limitations of the processing speed.

### Features

- Add/edit (images and texts)/delete Signage content/change playback times and names.
- Add images and videos on mobile devices.
- You can use images added from USB/SD storage devices and internal memory.

### How to Use

- Monitors: Run the app in the Launcher bar and add/edit/delete the desired content.
- Mobile devices: Run the app in the Launcher bar and get access using the QR code or URL provided.



### NOTE

- If you use a mobile device, you need to go through an authorization process using a PIN code. The default PIN code is '0000'.
- When using a PC, use the full screen (F11) feature in 1920 x 1080 (Full HD) resolution to view the same screen as the monitor.

### Photo Supported File

File Format	Format	Item
.jpeg, .jpg, .jpe	JPEG	<ul style="list-style-type: none"> <li>• Minimum : 64 x 64</li> <li>• Maximum               <ul style="list-style-type: none"> <li>- Normal Type: 15360 (W) x 8640 (H)</li> <li>- Progressive Type: 1920 (W) x 1440 (H)</li> </ul> </li> </ul>
.png	PNG	<ul style="list-style-type: none"> <li>• Minimum : 64 x 64</li> <li>• Maximum: 5760 (W) x 5760 (H)</li> </ul>

## Supported Video Codec

Extension	Codec	
.asf .wmv	Videos	VC-1 Simple and Main Profiles
	Audio	WMA Standard, WMA 10 Professional
.divx .avi	Videos	DivX3.11, DivX4, DivX5, DivX6, XViD, H.264/AVC, Motion Jpeg, MPEG-4 Part2
	Audio	MPEG-1 Layer I, II, MPEG-1 Layer III (MP3), Dolby Digital, LPCM, ADPCM, DTS
.mp4 .m4v .mov	Videos	H.264/AVC, MPEG-4 Part2
	Audio	AAC, MPEG-1 Layer III (MP3)
.3gp .3g2	Videos	H.264/AVC, MPEG-4 Part2
	Audio	AAC, AMR-NB, AMR-WB
.mkv	Videos	H.264/AVC
	Audio	HE-AAC, Dolby Digital
.ts .trp .tp .mts .m2ts	Videos	H.264/AVC, MPEG-2
	Audio	MPEG-1 Layer I, II, MPEG-1 Layer III (MP3), Dolby Digital, Dolby Digital Plus, AAC, PCM
.mpg .mpeg	Videos	MPEG-1, MPEG-2
	Audio	MPEG-1 Layer I, II, MPEG-1 Layer III (MP3), AAC
.vob	Videos	MPEG-1, MPEG-2
	Audio	Dolby Digital, MPEG-1 Layer I, II, DVD-LPCM

## Tips for Playing Video Files

- A damaged movie file may not play correctly, or some player features may not be usable.
- Movie files produced with some encoders may not be played correctly.
- Movie files other than the specified types and formats may not work properly.
- Max bit rate of playable movie file is 20 Mbps. (For Motion JPEG: 10 Mbps only)
- We do not guarantee smooth playback of profiles encoded level 4.1 or higher in H.264 / AVC.
- Video files larger than 50 MB may not upload properly from mobile devices. We recommend that you play such files via USB/SD storage devices.
- [For Ultra HD models only] Ultra HD image: 3840 X 2160  
Some HEVC-encoded Ultra HD videos other than the content officially provided by LG Electronics may not be played.

Extension	Codec	
.mkv .mp4 .ts	Video	H.264/AVC, HEVC
	Audio	Dolby Digital, Dolby Digital Plus, AAC, HE-AAC

- Some codecs can be used after upgrading software.

## Multi-Screen

- Only applies to certain models.

This feature allows you to view multiple external inputs and videos on a single screen.

### Accessing Multi-Screen

HOME → 

Enter **Multi-screen** to select the screen layout.

### ! NOTE

- When entering **Multi-screen**, the screen may flicker and the picture may appear abnormal on certain devices while the optimal resolution is selected automatically. If this happens, please restart the monitor.

### Selecting Screen Layout

When you enter **Multi-screen** without having set any screen layout, the screen layout selection menu appears.

If the screen layout menu does not appear, you can press the up arrow key on the remote control to go to the screen layout menu bar and select it to show the screen layout menu.

### Closing Screen Layout Menu

From the screen layout menu, press the up arrow key on the remote control to go to the screen layout menu bar and select it or press the **BACK** key to close the screen layout menu.

### Changing Screen Input

Press the  button on the top right of each split screen to select the desired input.

### ! NOTE

- Inputs which have already been selected for other split screens cannot be selected again. To select them, press the **RESET** button to reset the inputs for all screens first.

### Playing Videos on Split Screens

Press the  button on the upper right of each split screen, select **Video File**, and then select a storage device to view the list of videos in the selected device. Next, select your desired video from the list to play it.

### Tips for playing Multi-Screen files

- The number of split screens available may differ by model.
- Some tips on playing video files are included.
- Subtitles are not supported.
- Audio is only supported for the main screen.
- The following video types are supported in split mode.

<b>Codec</b>	MPEG-2, H.264, HEVC, VP9
<b>Scan Type</b>	Progressive
<b>Frame rate</b>	24, 25, 30
<b>Resolution</b>	PIP mode supports 3840 x 2160 (main screen only), 1920 x 1080 and 1280 x 720. PBP mode supports 1920 x 1080 and 1280 x 720.

- Certain videos may not play normally depending on codec, resolution, frame rate and scan type.

### ! NOTE

- Certain models may not support the following codec combinations when playing 3840 x 2160 resolution videos on the main screen in PIP mode.

Main (3840 x 2160)	Sub
HEVC	HEVC
H.264	HEVC
VP9	VP9

- When the 4-section screen has been selected in PBP mode, up to two H.264 and MPEG2 codecs can be used on condition that the HEVC codec is in use on one screen only.

### Resolutions supported on external input split screens

The following resolutions are supported when external input is selected.

Mode	Resolution		Frame Rate
PIP	Main	2160p	30
		1080p, 720p	50, 60
	Sub	1080p, 720p	
PBP	1080p, 720p		60
	960 x 600, 1280 x 600, 1920 x 300 (Only applies to the models that support the resolutions)		

- The resolutions supported on the split screens may differ depending on the resolutions supported by the model being used.

## PICTURE ID Settings

- Only applies to certain models.

**PICTURE ID** is used to change the settings of a specific set (display) using a single IR receiver for multi-vision. Communication is possible between a monitor with an IR receiver and other monitors using RS-232C cables. Each monitor is identified by a **Set ID**. If you assign the **PICTURE ID** using the remote control, only displays with matching **PICTURE ID** and **Set ID** can be controlled remotely.

- 1 Assign the **Set ID** to the installed monitors as shown below.

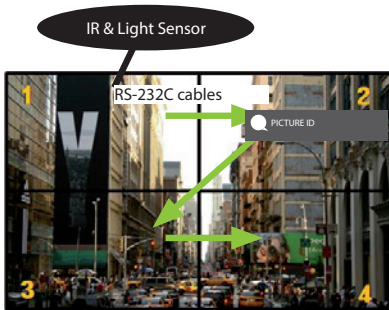











- 2 Press the red **ON** button on the remote control to assign the **PICTURE ID**.
- 3 Assign the **Set ID** to the selection of your choice.
  - A set with a different **Set ID** from the **PICTURE ID** cannot be controlled by IR signals.

### ! NOTE

- If **PICTURE ID** is set to 2, only the upper right monitor, which has a **Set ID** of 2, can be controlled by IR signals.
- If you press the green **OFF** button for **PICTURE ID**, the **PICTURE IDs** for all monitors are turned off. If you then press any button on the remote control, all monitors can be controlled by IR signals regardless of **Set ID**.

# IR CODES

All models do not support the HDMI/USB function.  
Some key codes may not be supported depending on the model.

Code (Hex)	Function	Remarks
08	 POWER	Remote control button
C4	MONITOR ON	Remote control button
C5	MONITOR OFF	Remote control button
95	Energy Saving	Remote control button
0B	INPUT	Remote control button
10	Number Key 0	Remote control button
11	Number Key 1	Remote control button
12	Number Key 2	Remote control button
13	Number Key 3	Remote control button
14	Number Key 4	Remote control button
15	Number Key 5	Remote control button
16	Number Key 6	Remote control button
17	Number Key 7	Remote control button
18	Number Key 8	Remote control button
19	Number Key 9	Remote control button
02	Volume  ( + )	Remote control button
03	Volume  ( - )	Remote control button
E0	BRIGHTNESS  (Page Up)	Remote control button
E1	BRIGHTNESS  (Page Down)	Remote control button
DC	3D	Remote control button
32	1/a/A	Remote control button
2F	CLEAR	Remote control button
7E	 SIMPLINK	Remote control button
79	ARC(MARK) (Aspect Ratio)	Remote control button
4D	PSM (Picture Mode)	Remote control button
09	MUTE	Remote control button
43	SETTINGS (Menu)	Remote control button
99	Auto Config.	Remote control button
40	Up 	Remote control button
41	Down 	Remote control button
06	Right 	Remote control button
07	Left 	Remote control button
44	OK	Remote control button
28	BACK	Remote control button

Code (Hex)	Function	Remarks
7B	TILE	Remote control button
5B	EXIT	Remote control button
72	PICTURE ID ON (RED)	Remote control button
71	PICTURE ID OFF (GREEN)	Remote control button
63	YELLOW	Remote control Button
61	BLUE	Remote control button
B1	■	Remote control button
B0	▶	Remote control button
BA		Remote control button
8F	◀◀	Remote control button
8E	▶▶	Remote control button
5F	W.BAL	Remote control button
3F	S.MENU	Remote control button
7C	HOME	Remote control button

\* Some key codes are not supported depending on the model.

# TO CONTROL MULTIPLE PRODUCTS

- Only applies to certain models.

Use this method to connect several products to a single PC. You can control several products at a time by connecting them to a single PC.

In the Option menu, the Set ID must be between 1 and 1000 without being duplicated.

## Connecting the Cable

- The image may be different according to the model.

Connect the RS-232C cable as shown in the picture.

The RS-232C protocol is used for communication between the PC and product. You can turn the product on or off, select an input source or adjust the OSD menu from your PC.

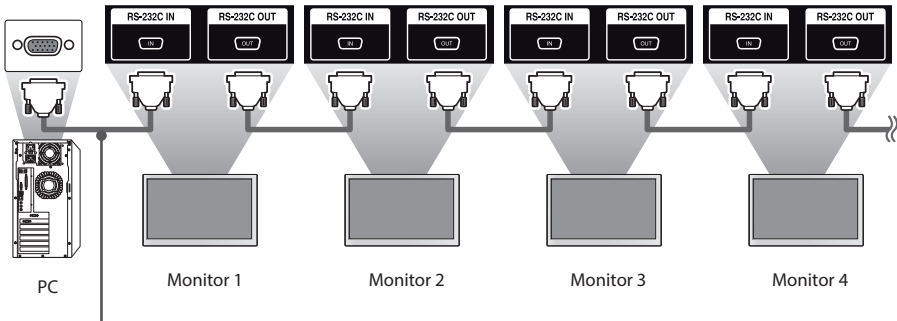
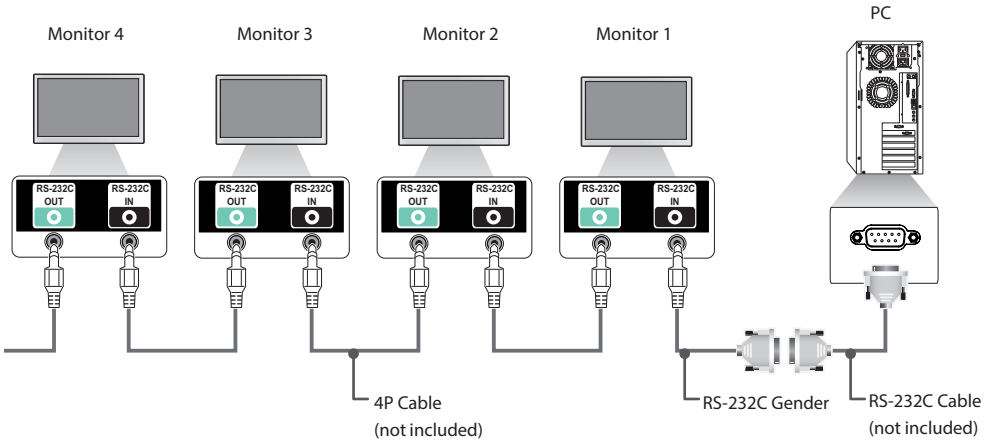

RS-232C Cable (not included)

## Communication Parameter

Baud Rate: 9600 BPS

Data Length: 8 bit

Parity Bit: None

Stop Bit: 1 bit

Flow Control: None

Communication Code: ASCII code

### ! NOTE

- When using three-wire connections (non-standard), an IR daisy chain cannot be used.
- Be sure to only use the provided gender to connect properly.
- When monitors connected via Daisy Chain (that controls multiple monitors) are turned off and on successively, some monitors may not turn on. In this case, you can turn those monitors on by pressing the **MONITOR ON** button, not the **POWER** button.

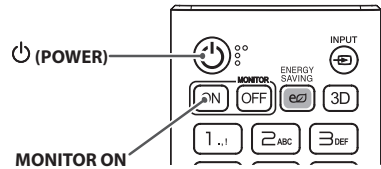

## Command Reference List

		COMMAND		DATA (Hexadecimal)
		1	2	
01	Power	k	a	00 to 01
02	Select input	x	b	See Select Input
03	Aspect Ratio	k	c	See Aspect Ratio
04	Energy Saving	j	q	See Energy Saving
05	Picture Mode	d	x	See Picture Mode
06	Contrast	k	g	00 to 64
07	Brightness	k	h	00 to 64
08	Sharpness	k	k	00 to 32
09	Color	k	i	00 to 64
10	Tint	k	j	00 to 64
11	Color temperature	x	u	00 to 64
12	Balance	k	t	00 to 64
13	Sound Mode	d	y	See Sound Mode
14	Mute	k	e	00 to 01
15	Volume Control	k	f	00 to 64
16	Time 1 (year/month/day)	f	a	See Time 1
17	Time 2 (hour/minute/second)	f	x	See Time 2
18	Off time schedule	f	c	00 to 01
19	On Time Schedule	f	b	00 to 01
20	Off Timer (Repeat/Time)	f	e	See Off Timer
21	On Timer (Repeat/Time)	f	d	See On Timer
22	On Timer Input	f	u	Refer to On Timer Input.
23	No Signal Power Off (15Min)	f	g	00 to 01
24	Auto Power Off (4 Hours)	m	n	00 to 01
25	Language	f	i	See Language
26	Reset	f	k	00 to 02
27	Current Temperature	d	n	FF
28	Key	m	c	See Key
29	Time Elapsed	d	l	FF
30	Product Serial Number	f	y	FF
31	Software Version	f	z	FF
32	White Balance Red Gain	j	m	00 to FE
33	White Balance Green Gain	j	n	00 to FE
34	White Balance Blue Gain	j	o	00 to FE
35	White Balance Red Offset	s	x	00 to 7F
36	White Balance Green Offset	s	y	00 to 7F
37	White Balance Blue Offset	s	z	00 to 7F
38	Backlight	m	g	00 to 64
39	Screen off	k	d	00 to 01

		COMMAND		DATA (Hexadecimal)
		1	2	
40	Tile Mode	d	d	00 to FF
41	Check Tile Mode	d	z	FF
42	Tile ID	d	i	See Tile ID
43	Natural Mode	d	j	00 to 01
44	DPM Select	f	j	00 to 07
45	Remote Control/Local Key Lock	k	m	00 to 01
46	Power On Delay	f	h	00 to FA
47	Fail Over Select	m	i	00 to 02
48	Fail Over Input Select	m	j	See Fail Over Input Select
49	IR Operation	t	p	00 to 02
50	Local Key Operation	t	o	00 to 02
51	Check the status	s	v	See Check the status
52	Check Screen	t	z	00 to 01
53	Speakers	d	v	00 to 01
54	Daylight Saving Time	s	d	Refer to 'Daylight Saving Time'
55	PM Mode	s	n, 0c	00 to 03
56	ISM Method	j	p	See ISM Method
57	Network Settings	s	n, 80(81)(82)	See Network Settings
58	Auto-adjustment	j	u	01
59	H Position	f	q	00 to 64
60	V Position	f	r	00 to 64
61	H Size	f	s	00 to 64
62	Power On Status	t	r	00 to 02
63	Wake On LAN	f	w	00 to 01
64	Intelligent Auto	t	i	00 to 01
65	OSD Portrait Mode	t	h	00 to 02
66	Reset to Initial Settings	t	n	00 to 01
67	Time Sync	s	n, 16	00 to 01
68	Contents Sync	t	g	00 to 01
69	Pivot Mode	t	a	00 to 01
70	Studio Mode	s	n, 83	00 to 01
71	LAN Daisy Chain	s	n, 84	00 to 01
72	Content Rotation	s	n, 85	00 to 02
73	DPM Wake up Control	s	n, 0b	00 to 01
74	Scan Inversion	s	n, 87	00 to 01
75	Beacon	s	n, 88	00 to 01
76	Aspect Ratio(Rotation)	s	n, 89	00 to 01

		COMMAND		DATA (Hexadecimal)
		1	2	
77	Easy Brightness Control Mode	s	m	00 to 01
78	Easy Brightness Control Schedule	s	s	See Easy Brightness Control Schedule
79	MultiScreen Mode & Input	x	c	See MultiScreen Mode & Input
80	Aspect Ratio(MultiScreen)	x	d	See Aspect Ratio(MultiScreen)
81	Screen Mute(MultiScreen)	x	e	See Screen Mute(MultiScreen)
82	Screen Off Always	s	n, 0d	00 to 01
83	Screen Video Freeze	k	x	00 to 01
84	Wireless Wake On LAN	s	n, 90	00 to 01
85	OSD Display	k	l	00 to 01
86	UPnP Mode	s	n, 9c	00 to 01

\* Note: Commands may not work when the external input is not used. Some commands may not be supported depending on the model.

## Transmission/Reception Protocol

### Transmission

[Command1][Command2][ ][Set ID][ ][Data][Cr]

- \* [Command1]: identifies between the factory setting and the user setting modes.
- \* [Command2]: controls monitor sets.
- \* [Set ID]: Used for selecting a set you want to control. A unique Set ID can be assigned to each set ranging from 1 to 1000(01H~3E8H) under Settings in the OSD menu.  
Selecting '00H' for Set ID allows the simultaneous control of all connected monitors.  
(The maximum value may differ depending on the model.)
- \* [Data]: Transmits command data.  
Data count may increase depending on the command.
- \* [Cr]: Carriage Return. Corresponds to '0x0D' in ASCII code.
- \* [ ]: White Space. Corresponds to '0x20' in ASCII code.

### Acknowledgement

[Command2][ ][Set ID][ ][OK/NG][Data][x]

- \* The Product transmits ACK (acknowledgement) based on this format when receiving normal data. At this time, if the data is FF, it indicates the present status data. If the data is in data write mode, it returns the data of the PC computer.
- \* If a command is sent with Set ID '00' (=0x00), the data is reflected to all monitor sets and each monitor set does not send an acknowledgement (ACK).
- \* If the data value 'FF' is sent in control mode via RS-232C, the current setting value of a function can be checked (only for some functions).
- \* Some commands are not supported depending on the model.

**01. Power (Command: k a)**

Controls the power on/off of the set.

**Transmission****[k][a][ ][Set ID][ ][Data][Cr]**Data 00: Off  
01: On**Acknowledgement****[a][ ][Set ID][ ][OK/NG][Data][x]**

\*The acknowledgement signal is returned properly only when the monitor is fully powered on.

\* There may be a delay between the transmission and acknowledgement signals.

**02. Select Input (Command: x b)**

Selects an input signal.

**Transmission****[x][b][ ][Set ID][ ][Data][Cr]**Data 20: AV  
40: COMPONENT  
60: RGB  
70: DVI-D (PC)  
80: DVI-D (DTV)  
90: HDMI1 (DTV)  
A0: HDMI1 (PC)  
91: HDMI2/OPS (DTV)  
A1: HDMI2/OPS (PC)  
92: OPS/HDMI3/DVI-D (DTV)  
A2: OPS/HDMI3/DVI-D (PC)  
95: OPS/DVI-D (DTV)  
A5: OPS/DVI-D (PC)  
96: HDMI3/DVI-D (DTV)  
A6: HDMI3/DVI-D (PC)  
C0: DISPLAYPORT (DTV)  
D0: DISPLAYPORT (PC)  
E0: SuperSign webOS Player  
E1: Others  
E2: Multi Screen**Acknowledgement****[b][ ][Set ID][ ][OK/NG][Data][x]**

\* Some input signals may not be supported depending on the model.

\*\* If it is not distributed from SuperSign W, webOS Player returns NG.

**03. Aspect Ratio (Command: k c)**

Adjusts the aspect ratio.

**Transmission****[k][c][ ][Set ID][ ][Data][Cr]**Data 01: 4:3  
02: 16:9  
04: Zoom  
06: Set by Program  
09: Just Scan (720p or higher)  
10 to 1F: Cinema Zoom 1 to 16  
21: 58:9  
30: Vertical Zoom  
31: All-Direction Zoom

\* Available data types differ depending on the input signal. For more information, see the aspect ratio section of the owner's manual.

\* The aspect ratio may differ depending on the model's input configuration.

**Acknowledgement****[c][ ][Set ID][ ][OK/NG][Data][x]****04. Energy Saving (Command: j q)**

Sets the Energy Saving.

**Transmission****[j][q][ ][Set ID][ ][Data][Cr]**Data 00: Off  
01: Minimum  
02: Medium  
03: Maximum  
04: Automatic  
05: Screen off**Acknowledgement****[q][ ][Set ID][ ][OK/NG][Data][x]**

\*\* This may not be supported depending on the model.

**05. Picture Mode (Command: d x)**

Selects a picture mode.

**Transmission****[d][x][ ][Set ID][ ][Data][Cr]**Data 00: Vivid  
01: Standard  
02: Cinema  
03: Sports  
04: Game  
05: Expert 1  
06: Expert 2  
08: APS  
09: Photos  
10: Touch  
11: Calibration**Acknowledgement****[x][ ][Set ID][ ][OK/NG][Data][x]**

\* Depending on the model, some picture modes may not be supported.

**06. Contrast (Command: k g)**

Adjusts the screen contrast.

Transmission

[k][g][ ][Set ID][ ][Data][Cr]

Data 00 to 64: Contrast 0 to 100

Acknowledgement

[g][ ][Set ID][ ][OK/NG][Data][x]

**07. Brightness (Command: k h)**

Adjusts the screen brightness.

Transmission

[k][h][ ][Set ID][ ][Data][Cr]

Data 00 to 64: Brightness 0 to 100

Acknowledgement

[h][ ][Set ID][ ][OK/NG][Data][x]

**08. Sharpness (Command: k k)**

Adjusts the screen sharpness.

Transmission

[k][k][ ][Set ID][ ][Data][Cr]

Data 00 to 32: Sharpness 0 to 50

Acknowledgement

[k][ ][Set ID][ ][OK/NG][Data][x]

**09. Color (Command: k i)**

Adjusts the screen color.

Transmission

[k][i][ ][Set ID][ ][Data][Cr]

Data 00 to 64: Color 0 to 100

Acknowledgement

[i][ ][Set ID][ ][OK/NG][Data][x]

**10. Tint (Command: k j)**

Adjusts the screen tint.

Transmission

[k][j][ ][Set ID][ ][Data][Cr]

Data 00 to 64: Tint red 50 to green 50

Acknowledgement

[j][ ][Set ID][ ][OK/NG][Data][x]

**11. Color Temperature (Command: x u)**

Adjusts the screen color temperature.

Transmission

[x][u][ ][Set ID][ ][Data][Cr]

Data 00 to 64: warm 50 to cool 50

Acknowledgement

[u][ ][Set ID][ ][OK/NG][Data][x]

**12. Balance (Command: k t)**

Adjusts the sound balance.

Transmission

[k][t][ ][Set ID][ ][Data][Cr]

Data 00 to 64: left 50 to right 50

Acknowledgement

[t][ ][Set ID][ ][OK/NG][Data][x]

**13. Sound mode (Command: d y)**

Selects a sound mode.

Transmission

[d][y][ ][Set ID][ ][Data][Cr]

Data           01: Standard  
                   02: Music  
                   03: Cinema  
                   04: Sports  
                   05: Game  
                   07: News (Clear Voice III)

Acknowledgement

[y][ ][Set ID][ ][OK/NG][Data][x]

**14. Mute (Command: k e)**

Mutes/unmutes the sound.

Transmission

[k][e][ ][Set ID][ ][Data][Cr]

Data           00: Mute  
                   01: Unmute

Acknowledgement

[e][ ][Set ID][ ][OK/NG][Data][x]

**15. Volume Control (Command: k f a)**

Adjusts the playback volume.

Transmission

[k][f][a][ ][Set ID][ ][Data][Cr]

Data           00 to 64: Volume 0 to 100

Acknowledgement

[f][ ][Set ID][ ][OK/NG][Data][x]

**16. Time 1 (year/month/day) (Command: f a)**

Sets the values of the Time 1 (year/month/day), or sets the Auto time.

Transmission

1. [f][a][ ][Set ID][ ][Data1][ ][Data2][ ][Data3][Cr]

2. [f][a][ ][Set ID][ ][0][0][ ][Data1][ ][Cr]

1. Setting the Time 1 (year/month/day)

Data1       04~1B: year 2014 to 2037

Data2       01 to 0C: January to December

Data3       01 to 1F: 1st to 31st

\* Enter "fa [Set ID] ff" to view the Time 1 (year/month/day) settings.

2. Setting the Auto time

Data1       00: Auto

01: Manual

\* To view the set value of the Auto time, enter "fa [Set ID] 00 ff".

Acknowledgement

1. [a][ ][Set ID][ ][OK/NG][Data1][Data2][Data3][x]

2. [a][ ][Set ID][ ][OK/NG][0][0][Data1][x]

**17. Time 2 (hour/minute/second) (Command: f x)**

Adjusts the Time 2 (hour/minute/second) value.

Transmission

[f][x][ ][Set ID][ ][Data1][ ][Data2][ ][Data3][Cr]

Data1       00 to 17: 00 to 23 hours

Data2       00 to 3B: 00 to 59 minutes

Data3       00 to 3B: 00 to 59 seconds

\* Enter "fx [Set ID] ff" to view the Time 2 (hour/minute/second) settings.

\*\* This function is only available when Time 1 (year/month/day) is set.

Acknowledgement

[x][ ][Set ID][ ][OK/NG][Data1][Data2][Data3][x]

**18. Off Time Schedule (Command: f c)**

Enables/disables the Off Time Schedule.

Transmission

[f][c][ ][Set ID][ ][Data][Cr]

Data           00: Off

01: On

Acknowledgement

[c][ ][Set ID][ ][OK/NG][Data][x]

**19. On Time Schedule (Command: f b)**

Enables/disables the On Time schedule.

Transmission

[f][b][ ][Set ID][ ][Data][Cr]

Data           00: Off

01: On

Acknowledgement

[b][ ][Set ID][ ][OK/NG][Data][x]

**20. Off Timer (Repeat/Time) (Command: f e)**

Configures Off Timer (Repeat/Time) settings.

**Transmission****[f][e][ ][Set ID][ ][Data1][ ][Data2][ ][Data3][Cr]****Data1**

1. f1h to f7h (reading data)

F1: reads the 1st Off Timer data

F2: reads the 2nd Off Timer data

F3: reads the 3rd Off Timer data

F4: reads the 4th Off Timer data

F5: reads the 5th Off Timer data

F6: reads the 6th Off Timer data

F7: reads the 7th Off Timer data

2. e1h-e7h (delete one index), e0h (delete all indexes)

E0: erases all Off Timer settings

E1: erases the 1st Off Timer setting

E2: erases the 2nd Off Timer setting

E3: erases the 3rd Off Timer setting

E4: erases the 4th Off Timer setting

E5: erases the 5th Off Timer setting

E6: erases the 6th Off Timer setting

E7: erases the 7th Off Timer setting

3. 01h to 0Ch (sets the day of the week for the Off Timer)

01: Once

02: Daily

03: Mon - Fri

04: Mon - Sat

05: Sat - Sun

06: Every Sunday

07: Every Monday

08: Every Tuesday

09: Every Wednesday

0A: Every Thursday

0B: Every Friday

0C: Every Saturday

Data2 00 to 17:00 to 23 hours

Data3 00 to 38:00 to 59 minutes

\* To read or delete the Off Time Schedule list, [Data2][Data3] must be set to FFH.

Example 1: fe 01 f1 ffff - reads the first index data in Off Timer.

Example 2: fe 01 e1 ffff - deletes the first index data from Off Timer.

Example 3: fe 01 04 02 03 - sets Off Timer to 02:03 from Monday to Saturday.

\* This function is only available when Time 1 (year/month/day) and Time 2 (hour/minute/second) are set.

**Acknowledgement****[e][ ][Set ID][ ][OK/NG][Data1][Data2][Data3][x]****21. On timer (Repeat/Time) (Command: f d)**

Configures On Timer (Repeat/Time) settings.

**Transmission****[f][d][ ][Set ID][ ][Data1][ ][Data2][ ][Data3][Cr]****Data1**

1. f1h to f7h (reading data)

F1: reads the 1st On Timer data

F2: reads the 2nd On Timer data

F3: reads the 3rd On Timer data

F4: reads the 4th On Timer data

F5: reads the 5th On Timer data

F6: reads the 6th On Timer data

F7: reads the 7th On Timer data

2. e1h-e7h (delete one index), e0h (delete all indexes)

E0: erases all On Timer settings

E1: erases the 1st On Timer setting

E2: erases the 2nd On Timer setting

E3: erases the 3rd On Timer setting

E4: erases the 4th On Timer setting

E5: erases the 5th On Timer setting

E6: erases the 6th On Timer setting

E7: erases the 7th On Timer setting

3. 01h to 0Ch (sets the day of the week for the On Timer)

01: Once

02: Daily

03: Mon - Fri

04: Mon - Sat

05: Sat - Sun

06: Every Sunday

07: Every Monday

08: Every Tuesday

09: Every Wednesday

0A: Every Thursday

0B: Every Friday

0C: Every Saturday

Data2 00 to 17:00 to 23 hours

Data3 00 to 38:00 to 59 minutes

\* To read or delete an On Time schedule list, [Data2][Data3] must be set to FF.

Example 1: fd 01 f1 ffff - reads the first index data from On Timer.

Example 2: fd 01 e1 ffff - deletes the first index data from On Timer.

Example 3: fd 01 04 02 03 - sets On Timer to 02:03 from Monday to Saturday.

\* This function is only available when Time 1 (year/month/day) and Time 2 (hour/minute/second) are set.

\*\*\* This feature works properly only when the values for 22.

**Acknowledgement****[d][ ][Set ID][ ][OK/NG][Data1][Data2][Data3][x]**

**22. On Timer Input (Command: f u)**

Select an external input for the current On Time setting and add a new schedule.

Transmission

[f][u][ ][Set ID][ ][Data1][Cr]

[f][u][ ][Set ID][ ][Data1][ ][Data2][Cr]

Data (Add schedule)

40: COMPONENT

60: RGB

70: DVI-D

A0: HDMI1

A1: HDMI2/OPS

A2: OPS/HDMI3/DVI-D

A5: OPS/DVI-D

A6: HDMI3/DVI-D

D0: DISPLAYPORT

Data1 (Read schedule)

1. f1h to f7h (Read data)

F1: Select the 1st schedule input

F2: Select the 2nd schedule input

F3: Select the 3rd schedule input

F4: Select the 4th schedule input

F5: Select the 5th schedule input

F6: Select the 6th schedule input

F7: Select the 7th schedule input

Data2 (Read schedule)

FF

\* To read the schedule input, enter FF for [Data2].

If no schedule is available for [Data1] when attempting to read the schedule data, the text 'NG' will be displayed and the operation will fail.

(Example 1: fu 01 90 - Move each schedule input down one row and save the 1st schedule input in HDMI mode.)

(Example 2: fu 01 f1 ff - Read the 1st schedule input.)

\* This function is supported only when 1 (Year/Month/Day), 2 (Hour/Minute/Second), On Time (Repeat Mode/Time) are set.

\*\* When in DTV input mode, the input is switched to PC mode.

\*\* It may not be supported depending on the model.

Acknowledgement

[u][ ][Set ID][ ][OK/NG][Data][x]

[u][ ][Set ID][ ][OK/NG][Data1][Data2][x]

**23. No Signal Power Off (15Min) (Command: f g)**

Sets the monitor to enter Automatic Standby mode if there is no signal for 15 minutes.

Transmission

[f][g][ ][Set ID][ ][Data][Cr]

Data 00: Off

01: On

Acknowledgement

[g][ ][Set ID][ ][OK/NG][Data][x]

**24. Auto Power Off (4 Hours) (Command: m n)**

Sets the monitor to enter Auto Power Off after 4 hours.

Transmission

[m][n][ ][Set ID][ ][Data][Cr]

Data 00: Off

01: 4 hours

Acknowledgement

[n][ ][Set ID][ ][OK/NG][Data][x]

**25. Language (Command: f i)**

Sets the OSD language.

Transmission

[f][i][ ][Set ID][ ][Data][Cr]

Data 00: Czech

01: Danish

02: German

03: English

04: Spanish (Europe)

05: Greek

06: French

07: Italian

08: Dutch

09: Norwegian

0A: Portuguese

0B: Portuguese (Brazil)

0C: Russian

0D: Finnish

0E: Swedish

0F: Korean

10: Chinese (Mandarin)

11: Japanese

12: Chinese (Cantonese)

Acknowledgement

[i][ ][Set ID][ ][OK/NG][Data][x]

**26. Reset (Command: f k)**

Performs the reset function.

Screen Reset can only be performed in RGB input mode.

Transmission

[f][k][ ][Set ID][ ][Data][Cr]

Data 00: Picture Reset  
01: Screen reset  
02: Initial Settings

Acknowledgement

[k][ ][Set ID][ ][OK/NG][Data][x]

\*\* It may not be supported depending on the model.

**27. Current temperature (Command: d n)**

Checks the inside temperature.

Transmission

[d][n][ ][Set ID][ ][Data][Cr]

Data FF: Check the status

Acknowledgement

[n][ ][Set ID][ ][OK/NG][Data][x]

\* Temperature is displayed as a hexadecimal value.

**28. Key (Command: m c)**

Sends a key code for the IR remote control.

Transmission

[m][c][ ][Set ID][ ][Data][Cr]

Data IR\_KEY\_CODE

Acknowledgement

[c][ ][Set ID][ ][OK/NG][Data][x]

For key codes, see IR Codes.

\* Some key codes are not supported depending on the model.

**29. Time Elapsed (Command: d l)**

Checks the elapsed time.

Transmission

[d][l][ ][Set ID][ ][Data][Cr]

Data FF: Read status

Acknowledgement

[l][ ][Set ID][ ][OK/NG][Data][x]

\* The data received is shown as a hexadecimal value.

**30. Product serial number (Command: f y)**

Checks the serial number of the product.

Transmission

[f][y][ ][Set ID][ ][Data][Cr]

Data FF: Check product serial number

Acknowledgement

[y][ ][Set ID][ ][OK/NG][Data][x]

\* Data is in ASCII code.

**31. Software Version (Command: f z)**

Checks the software version of the product.

Transmission

[f][z][ ][Set ID][ ][Data][Cr]

Data FF: Check software version

Acknowledgement

[z][ ][Set ID][ ][OK/NG][Data][x]

**32. White balance red gain (Command: j m)**

Adjusts the white balance red gain value.

Transmission

[j][m][ ][Set ID][ ][Data][Cr]

Data 00 to FE: Red Gain 0 to 254  
FF: checks the red gain value

Acknowledgement

[m][ ][Set ID][ ][OK/NG][Data][x]

**33. White Balance Green Gain (Command: j n)**

Adjusts the white balance green gain value.

Transmission

[j][n][ ][Set ID][ ][Data][Cr]

Data 00 to FE: Green Gain 0 to 254  
FF: checks the green gain value

Acknowledgement

[n][ ][Set ID][ ][OK/NG][Data][x]

**34. White Balance Blue Gain (Command: j o)**

Adjusts the white balance blue gain value.

Transmission

[j][o][ ][Set ID][ ][Data][Cr]

Data 00 to FE: Blue Gain 0 to 254  
FF: checks the blue gain value

Acknowledgement

[o][ ][Set ID][ ][OK/NG][Data][x]

**35. White Balance Red Offset (Command: s x)**

Adjusts the white balance red offset value.

Transmission

[s][x][ ][Set ID][ ][Data][Cr]

Data 00 to 7F: Red Offset 0 to 127  
FF: checks the red offset value

Acknowledgement

[x][ ][Set ID][ ][OK/NG][Data][x]

**36. White Balance Green Offset (Command: s y)**

Adjusts the white balance green offset value.

Transmission

[s][y][ ][Set ID][ ][Data][Cr]

Data 00 to 7F: Green Offset 0 to 127  
FF: checks the green offset value

Acknowledgement

[y][ ][Set ID][ ][OK/NG][Data][x]

**37. White Balance Blue Offset (Command: s z)**

Adjusts the white balance blue offset value.

Transmission

[s][z][ ][Set ID][ ][Data][Cr]

Data 00 to 7F: Blue Offset 0 to 127  
FF: checks the blue offset value

Acknowledgement

[z][ ][Set ID][ ][OK/NG][Data][x]

**38. Backlight (Command: m g)**

Adjusts the backlight brightness.

Transmission

`[m][g][ ][Set ID][ ][Data][Cr]`

Data 00 to 64: Backlight 0 to 100

Acknowledgement

`[g][ ][Set ID][ ][OK/NG][Data][x]`**39. Screen Off (Command: k d)**

Turns the screen on or off.

Transmission

`[k][d][ ][Set ID][ ][Data][Cr]`Data 00: turns the screen on  
01: turns the screen off

Acknowledgement

`[d][ ][Set ID][ ][OK/NG][Data][x]`**40. Tile Mode (Command: d d)**

Sets the Tile Mode and sets values for the tile rows and columns.

Transmission

`[d][d][ ][Set ID][ ][Data][Cr]`Data 00 to FF: The first byte - tile column  
The second byte - tile row

\* 00, 01, 10, and 11 mean that the tile mode is off

\*\* The maximum value may differ depending on the model.

Acknowledgement

`[d][ ][Set ID][ ][OK/NG][Data][x]`**41. Check Tile Mode (Command: d z)**

Checks the tile mode.

Transmission

`[d][z][ ][Set ID][ ][Data][Cr]`

Data FF: checks the tile mode

Acknowledgement

`[z][ ][Set ID][ ][OK/NG][Data1][Data2][Data3][x]`

Data1 00: tile mode off

01: tile mode on

Data2 00 to 0F: tile column

Data3 00 to 0F: tile row

**42. Tile ID (Command: d i)**

Sets the tile ID value of the product.

Transmission

`[d][i][ ][Set ID][ ][Data][Cr]`

Data 01 to E1: Tile ID 1 to 225\*\*

FF: checks the tile ID

\*\* The data value cannot exceed the value of row x column.

Acknowledgement

`[i][ ][Set ID][ ][OK/NG][Data][x]`

\* When a data value that exceeds the value of row x column is entered (except 0xFF), ACK becomes NG.

**43. Natural Mode (in Tile mode) (Command: d j)**

When displaying the image naturally, the part of the image that would normally be displayed in the gap between the monitors is omitted.

Transmission

`[d][j][ ][Set ID][ ][Data][Cr]`

Data 00: Off

01: On

Acknowledgement

`[j][ ][Set ID][ ][OK/NG][Data][x]`

**44. DPM Select (Command: f j)**

To set the DPM (Display Power Management) function.

**Transmission**

[f][j][ ][Set ID][ ][Data][Cr]

Data 00: Off  
 01: 5 seconds  
 02: 10 seconds  
 03: 15 seconds  
 04: 1 minutes  
 05: 3 minutes  
 06: 5 minutes  
 07: 10 minutes

**Acknowledgement**

[j][ ][Set ID][ ][OK/NG][Data][x]

**45. Remote Control/Local Key Lock (Command: k m)**

Adjusts the remote control/local key (front) lock.

**Transmission**

[k][m][ ][Set ID][ ][Data][Cr]

Data 00: Off (Lock Off)  
 01: On (Lock On)

\* When the monitor is turned off, the power key works even in On (01) mode.

**Acknowledgement**

[m][ ][Set ID][ ][OK/NG][Data][x]

**46. Power On Delay (Command: f h)**

Sets the schedule delay when the power turns on. (unit: seconds).

**Transmission**

[f][h][ ][Set ID][ ][Data][Cr]

Data 00 to FA: min. 0 to maximum 250 (seconds)

\* The maximum value may differ depending on the model.

**Acknowledgement**

[h][ ][Set ID][ ][OK/NG][Data][x]

**47. Fail Over Select (Command: m i)**

Selects an input mode for auto switch.

**Transmission**

[m][i][ ][Set ID][ ][Data][Cr]

Data 00: Off  
 01: Auto  
 02: Manual

**Acknowledgement**

[i][ ][Set ID][ ][OK/NG][Data][x]

**48. Fail Over Input Select (Command: m j)**

Selects an input source for auto switch.

\* This command is only available when the Fail Over (auto) mode is set to Custom.

**Transmission**

[m][j][ ][Set ID][ ][Data1][ ][Data2][ ][Data3][ ][Data4]...[ ][DataN][Cr]

Data 1 to N-1 (Input priority: 1 to N-1)

40: COMPONENT  
 60: RGB  
 70: DVI-D  
 90: HDMI1  
 91: HDMI2/OPS  
 92: OPS/HDMI3/DVI-D  
 95: OPS/DVI-D  
 96: HDMI3/DVI-D  
 C0: DISPLAYPORT

Data N: E0: INTERNAL Memory  
 E1: USB  
 E2: SD CARD

**Acknowledgement**

[j][ ][Set ID][ ][OK/NG][Data1][Data2][Data3][Data4]...[DataN][x]

Data 1 to N-1 (Input priority: 1 to N-1)

40: COMPONENT  
 60: RGB  
 70: DVI-D  
 90: HDMI1  
 91: HDMI2/OPS  
 92: OPS/HDMI3/DVI-D  
 95: OPS/DVI-D  
 96: HDMI3/DVI-D  
 C0: DISPLAYPORT

Data N: E0: INTERNAL Memory  
 E1: USB  
 E2: SD CARD

\* Some input signals may not be available with certain models.

\*\* The data number (N) may vary depending on the model. (The data number depends on the number of supported input signals.)

\*\*\* Only the value of E0, E1, or E2 is acceptable for the last data.

**49. IR Operation (Command: t p)**

Configures the IR operation settings of the product.

**Transmission**

[t][p][ ][Set ID][ ][Data][Cr]

Data 00: locks off all of the keys  
01: locks on all of the keys except the Power key  
02: locks on all of the keys

**Acknowledgement**

[x][ ][Set ID][ ][OK/NG][Data][x]

\* When the monitor is turned off, the power key works even in the locks on all of the keys (02) mode.

**50. Local Key Operation (Command: t o)**

Configures the local key operation settings of the product.

**Transmission**

[t][o][ ][Set ID][ ][Data][Cr]

Data 00: locks off all of the keys  
01: locks on all of the keys except the Power key  
02: locks on all of the keys

**Acknowledgement**

[o][ ][Set ID][ ][OK/NG][Data][x]

\* When the monitor is turned off, the power key works even in the locks on all of the keys (02) mode.

\*\* It may not be supported depending on the model.

**51. Status (Command: s v)**

Checks the current signal status of the product.

**Transmission**

[s][v][ ][Set ID][ ][Data][ ][FF][Cr]

Data 02: checks whether there is a signal or not  
03: check the PM mode.  
10: RGB sensing OK/NG (Check Screen)

**Acknowledgement**

[v][ ][Set ID][ ][OK/NG][Data][Data1][x]

Data: 02 (when a signal is found)  
Data1 00: no signal  
01: there is a signal

Data: 03 (when checking the PM mode)  
Data1 00: The PM mode is set to Screen On  
01: The PM mode is set to Screen Off  
02: The PM mode is set to Screen Off Always

Data: 10 (Check Screen)  
Data1 00: Check Screen result NG  
07: Check Screen result OK

\* Sets to NG when Check Screen is set to Off or not supported.

\*\* It may not be supported depending on the model.

**52. Check Screen (Command: t z)**

Sets Check Screen.

**Transmission**

[t][z][ ][Set ID][ ][Data][Cr]

Data 00: Off  
01: On

**Acknowledgement**

[z][ ][Set ID][ ][OK/NG][Data][x]

\*\* It may not be supported depending on the model.

**53. Speaker (Command: d v)**

Sets the speaker function.

**Transmission**

[d][v][ ][Set ID][ ][Data][Cr]

Data 00: Off  
01: On

**Acknowledgement**

[v][ ][Set ID][ ][OK/NG][Data][x]

\*\* It may not be supported depending on the model.

**54. Daylight Saving Time (Command: s d)**

To set the Daylight Saving Time function.

**Transmission**

[s][d][ ][Set ID][ ][Data1][ ][Data2][ ][Data3][ ][Data4][ ][Data5][Cr]

Data 00: Off (Data2~5: FFH)  
01: Start Time  
02: End Time

Data2 01~0C: January to December

Data3 01~06: 1 ~ 6th week

\* The maximum number of [Data3] differs depending on Date.

Data4 00~06 (Sun. ~ Sat.)

Data5 00~17: 00 ~ 23 hours

\* To read the Start Time/End Time, enter FFH for [Data2]~[Data5].

(ex1: sd 01 01 ff ff ff ff - To check the Start Time

ex2: sd 01 02 ff ff ff ff - To check the End Time)

\* This function is supported only when 1 (Year/Month/ Day) and 2 (Hour/Minute/Second) are set.

**Acknowledgement**

[d][ ][Set ID][ ][OK/NG][Data1][Data2][Data3][Data4][Data5][x]

\*\* It may not be supported depending on the model.

**55. PM Mode (Command: s n, 0c)**

Selects the desired PM mode option.

**Transmission**

[s][n][ ][Set ID][ ][0c][ ][Data][Cr]

Data 00: Sets the Power Off mode.  
01: Sets the Sustain Aspect Ratio mode.  
02: Sets the Screen Off mode.  
03: Sets the Screen Off Always mode.

**Acknowledgement**

[n][ ][Set ID][ ][OK/NG][0c][Data][x]

\* It may not be supported depending on the model.

**56. ISM Method (Command: j p)**

Selects the ISM Method option.

**Transmission**

[j][p][ ][Set ID][ ][Data][Cr]

Data 01: Inversion  
02: Orbiter  
04: White Wash  
08: Normal  
20: Color Wash  
80: Washing Bar  
90: User Image  
91: User Video

\*\* The jp command works when Timer is set to Immediately.

**Acknowledgement**

[p][ ][Set ID][ ][OK/NG][Data][x]

\* It may not be supported depending on the model.

**57. Network Settings (Command: s n, 80 or 81 or 82)**

Configures network and DNS settings.

**Transmission**

[s][n][ ][Set ID][ ][Data1][ ][Data2][ ][Data3][ ][Data4][ ][Data5][Cr]

Data1 80: Configures/views the temporary IP mode (Auto/Manual), subnet mask, and gateway.  
81: Configures/views the temporary DNS address.  
82: Saves temporary settings and views information about the current network.

\* If Data1 is 80,

Data2 00: Auto  
01: Manual  
FF: Views the temporary IP mode (Auto/Manual), subnet mask, and gateway.

\*\* If Data2 is 01 (Manual),

Data3 : Manual IP address  
Data4 : Subnet mask address  
Data5 : Gateway address

\* If Data1 is 81,  
Data2 : DNS address  
FF: Views the temporary DNS address.

\* If Data1 is 82,

Data2 80: Applies the temporarily saved IP mode (Auto/Manual), subnet mask, and gateway.  
81: Applies the temporary DNS address  
FF: Information on the current network (IP, subnet gateway, DNS)

\*\*\* Examples of settings

1. Auto: sn 01 80 00
2. Manual: sn 01 80 01 010177223241 255255254000 010177222001 (IP: 10.177.223.241, subnet: 255.255.254.0, gateway: 10.177.222.1)
3. Network read: sn 01 80 ff
4. DNS setting: sn 01 81 156147035018 (DNS: 156.147.35.18)
5. Applying the settings: sn 01 82 80 (applies the saved IP mode (auto/manual), subnet mask, and gateway)  
sn 01 82 81 (applies the saved DSN)

\*\*\*\* Each IP address contains 12 decimal digits .

**Acknowledgement**

[n][ ][Set ID][ ][OK/NG][Data1][Data][x]

\* It may not be supported depending on the model.

\*\* This feature is available only for wired networks.

**58. Auto-adjustment (Command: j u)**

Automatically corrects the position and shaking of the picture. (Works only in RGB-PC input mode.)

**Transmission**

[j][u][ ][Set ID][ ][Data][Cr]

Data 01: Execution

**Acknowledgement**

[u][ ][Set ID][ ][OK/NG][Data][x]

\* It may not be supported depending on the model.

**59. H Position (Command: f q)**

Adjusts the horizontal position of the screen. This feature only works when the Tile Mode is set to Off.

\* The operational range varies depending on the RGB input resolution. (Works only in RGB-PC input mode.)

**Transmission**

[f][q][ ][Set ID][ ][Data][Cr]

Data 00-64: Min -50 (Left) to Max 50 (Right)

**Acknowledgement**

[q][ ][Set ID][ ][OK/NG][Data][x]

\* It may not be supported depending on the model.

**60. V Position (Command: f r)**

Adjusts the vertical position of the screen. This feature only works when the Tile Mode is set to Off.

\* The operational range varies depending on the RGB input resolution. (Works only in RGB-PC input mode.)

Transmission

[f][r][ ][Set ID][ ][Data][Cr]

Data 00-64: Min -50 (Down) to Max 50 (Up)

Acknowledgement

[r][ ][Set ID][ ][OK/NG][Data][x]

\* It may not be supported depending on the model.

**61. H Size (Command: f s)**

Adjusts the horizontal size of the screen. This feature only works when the Tile Mode is set to Off.

\* The operational range varies depending on the RGB input resolution. (Works only in RGB-PC input mode.)

Transmission

[f][s][ ][Set ID][ ][Data][Cr]

Data 00-64: Min -50 (Small) to Max 50 (Large)

Acknowledgement

[s][ ][Set ID][ ][OK/NG][Data][x]

\* It may not be supported depending on the model.

**62. Power On Status (Command: t r)**

Selects the desired Power On status option.

Transmission

[t][r][ ][Set ID][ ][Data][Cr]

Data 00: LST (Stays in the previous status)  
01: STD (Stays powered off)  
02: PWR (Stays powered on)

Acknowledgement

[r][ ][Set ID][ ][OK/NG][Data][x]

**63. Wake On LAN (Command: f w)**

Selects the desired Wake On LAN option.

Transmission

[f][w][ ][Set ID][ ][Data][Cr]

Data 00: Off

01: On

Acknowledgement

[w][ ][Set ID][ ][OK/NG][Data][x]

**64. Intelligent Auto (Command: t i)**

Selects the desired Intelligent Auto option.

Transmission

[t][i][ ][Set ID][ ][Data][Cr]

Data 00: Off

01: On

Acknowledgement

[i][ ][Set ID][ ][OK/NG][Data][x]

\* It may not be supported depending on the model.

**65. OSD Portrait Mode (Command: t h)**

Selects the desired Portrait mode option.

Transmission

[t][h][ ][Set ID][ ][Data] [Cr]

Data 00: Off

01: 90 degrees

02: 270 degrees

Acknowledgement

[h][ ][Set ID][ ][OK/NG][Data] [x]

\* It may not be supported depending on the model.

**66. Reset to Initial Settings (Command: t n)**

Enables/disables the Reset to Initial settings.

Transmission

[t][n][ ][Set ID][ ][Data][Cr]

Data 00: Disables the settings.  
01: Enables the settings.

Acknowledgement

[n][ ][Set ID][ ][OK/NG][Data][x]

\* It may not be supported depending on the model.

**67. Time Sync (Command: s n, 16)**

Configures the Time Sync.

Transmission

[s][n][ ][Set ID][ ][1][6][ ][Data][Cr]

Data 00: Off  
01: On

\* This feature works in the Master mode.

\*\* This feature does not work if the current time is not set.

Acknowledgement

[n][ ][Set ID][ ][OK/NG][ ][1][6][ ][Data][x]

\* It may not be supported depending on the model.

**68. Contents Sync (Command: t g)**

Configures the Contents Sync.

Transmission

[t][g][ ][Set ID][ ][Data][Cr]

Data 00: Off  
01: On

Acknowledgement

[g][ ][Set ID][ ][OK/NG][Data][x]

\* It may not be supported depending on the model.

**69. Pivot Mode (Command: t a)**

Sets Pivot Mode to on/off.

Transmission

[t][a][ ][Set ID][ ][Data][Cr]

Data 00: Off  
01: On

Acknowledgement

[a][ ][Set ID][ ][OK/NG][Data][x]

\* This feature may not be supported in certain models.

**70. Studio Mode (Command: s n, 83)**

Sets Studio Mode to on/off.

Transmission

[s][n][ ][Set ID][ ][8][3][ ][Data][Cr]

Data 00: Off  
01: On

Acknowledgement

[n][ ][Set ID][ ][OK/NG][8][3][Data][x]

\* This feature may not be supported in certain models.

**71. LAN Daisy Chain (Command: s n, 84)**

Sets LAN Daisy Chain to on/off.

Transmission

[s][n][ ][Set ID][ ][8][4][ ][Data][Cr]

Data 00: Off  
01: On

Acknowledgement

[n][ ][Set ID][ ][OK/NG][8][4][Data][x]

\* This feature may not be supported in certain models.

**72. Content Rotation (Command: s n, 85)**

Sets Content Rotation to on/off.

Transmission

[s][n][ ][Set ID][ ][8][5][ ][Data][Cr]

Data 00: Off  
01: 90 degrees  
02: 270 degrees  
03: 180 degrees

Acknowledgement

[n][ ][Set ID][ ][OK/NG][8][5][Data][x]

\* This feature may not be supported in certain models.

**73. DPM Wake up Control (Command: s n, 0b)**

Sets the DPM Wake up Control Mode.

Transmission

[s][n][ ][Set ID][ ][0][b][ ][Data][Cr]

Data 00: Clock  
01: Clock+DATA

Acknowledgement

[n][ ][Set ID][ ][OK/NG][0][b][Data][x]

\* This feature may not be supported in certain models.

**74. Scan Inversion (Command: s n, 87)**

Sets Scan Inversion to on/off.

Transmission

[s][n][ ][Set ID][ ][8][7][ ][Data][Cr]

Data 00: Off  
01: On

Acknowledgement

[n][ ][Set ID][ ][OK/NG][8][7][Data][x]

\* This feature may not be supported in certain models.

**75. Beacon (Command: s n, 88)**

Sets Beacon to on/off.

Transmission

[s][n][ ][Set ID][ ][8][8][ ][Data][Cr]

Data 00: Off  
01: On

Acknowledgement

[n][ ][Set ID][ ][OK/NG][8][8][Data][x]

\* This feature may not be supported in certain models.

**76. Aspect Ratio (Rotation) (Command: s n, 89)**

Controls the Aspect Ratio (Rotation) screen.

(This command works only when Content Rotation is on.)

Transmission

[s][n][ ][Set ID][ ][8][9][ ][Data][Cr]

Data 00: Full  
01: Original

Acknowledgement

[n][ ][Set ID][ ][OK/NG][8][9][Data][x]

\* This feature may not be supported in certain models.

**77. Easy Brightness Control Mode (Command: s m)**

Selects whether to turn on/off Easy Brightness Control Mode.

Transmission

[s][m][ ][Set ID][ ][Data][Cr]

Data 00: Easy Brightness Control off  
01: Easy Brightness Control on

\* This feature does not work if the current time is not set.

\*\* This may not be supported on some models.

Acknowledgement

[m][ ][Set ID][ ][OK/NG][Data][x]

**78. Easy Brightness Control Schedule (Command: s s)**

Sets Easy Brightness Control schedules.

Transmission

[s][s][ ][Set ID][ ][Data1][ ][Data2][ ][Data3][Cr]

Data1

1. F1–F6 (reads data)

F1: Reads the 1st data from the Easy Brightness Control

F2: Reads the 2nd data from the Easy Brightness Control

F3: Reads the 3rd data from the Easy Brightness Control

F4: Reads the 4th data from the Easy Brightness Control

F5: Reads the 5th data from the Easy Brightness Control

F6: Reads the 6th data from the Easy Brightness Control

2. FF: Reads all stored lists

3. e1–e6 (deletes one index); e0 (deletes all indexes)

E0: Deletes all Easy Brightness Control.

E1: Deletes the 1st Easy Brightness Control.

E2: Deletes the 2nd Easy Brightness Control.

E3: Deletes the 3rd Easy Brightness Control.

E4: Deletes the 4th Easy Brightness Control.

E5: Deletes the 5th Easy Brightness Control.

E6: Deletes the 6th Easy Brightness Control.

4. 00 to 17:00th to 23th hour

Data2 00 to 3B: 00th to 59th minute

Data3 00 to 64: Backlight, 0 to 100

\* If you want to read or delete the configured Easy Brightness Control lists, set [Data2][Data3] to FF.

\* If you want to import all the configured Easy Brightness Control lists through FF, do not enter any values in [Data2][Data3].

\* When all the configured Easy Brightness Control lists are imported through FF, OK is acknowledged even if there is no stored list.

Example 1: ss 01 f1 ff ff - Reads the first index data from the Easy Brightness Control.

Example 2: ss 01 ff - Reads all index data from the Easy Brightness Control.

Example 3: ss 01 e1 ff ff - Deletes the first index data from the Easy Brightness Control.

Example 4: ss 01 07 1E 46 - Adds a schedule whose time is 07:30 and whose backlight is 70.

Acknowledgement

[s][ ][Set ID][ ][OK/NG][Data1][Data2][Data3][x]

\* This feature may not be supported in certain models.

**79. MultiScreen Mode & Input (Command: x c)**

Saves or controls the MultiScreen Mode and input.

Transmission

[x][c][ ][Set ID][ ][Data1][ ][Data2][ ][Data3][ ][Data4][ ][Data5][Cr]

Data1 (sets the MultiScreen Mode)

10: PIP

22: PBP2

23: PBP3

24: PBP4

Data2 (sets the MultiScreen Main Input)

Data3 (sets the MultiScreen Sub1 Input)

Data4 (sets the MultiScreen Sub2 Input)

Data5 (sets the MultiScreen Sub3 Input)

20: AV

40: COMPONENT

60: RGB

80: DVI-D

90: HDMI1

91: HDMI2/OPS

92: OPS/HDMI3/DVI-D

95: OPS/DVI-D

96: HDMI3/DVI-D

CO: DISPLAYPORT

Acknowledgement

[c][ ][Set ID][ ][OK/NG][ ][Data1][Data2][Data3][Data4][Data5][x]

\* This feature may not be supported in certain models.

\*\* Only the input modes supported by the model works.

**80. Aspect Ratio (MultiScreen) (Command: x d)**

Saves or controls the Aspect Ratio (MultiScreen) screen.

Transmission

[x][d][ ][Set ID][ ][Data1][ ][Data2][Cr]

Data1 01: Controls the Main input

02: Controls the Sub1 input

03: Controls the Sub2 input

04: Controls the Sub3 input

Data2 00: Full

01: Original

Acknowledgement

[d][ ][Set ID][ ][OK/NG][Data1][Data2][x]

\* This feature may not be supported in certain models.

**81. Screen Mute (MultiScreen) (Command: x e)**

Turns on/off each screen in MultiScreen.

**Transmission**

```
[x][e][ ][Set ID][ ][Data1][ ][Data2][Cr]
```

Data1 01: Controls the Main input  
02: Controls the Sub1 input  
03: Controls the Sub2 input  
04: Controls the Sub3 input

Data2 00: Turns the screen on.  
01: Turns the screen off.

\* This function works when the Multi Screen App is running.

\*\* This function may not work properly if there is no signal.

**Acknowledgement**

```
[e][ ][Set ID][ ][OK/NG][Data1][Data2][x]
```

\* This feature may not be supported in certain models.

**82. Screen Off Always (Command: s n, 0d)**

Screen Off Always has the same effect as entering the Screen Off menu regardless of the PM mode setting.

**Transmission**

```
[s][n][ ][Set ID][ ][0][d][ ][Data][Cr]
```

Data 00: Off  
01: On

**Acknowledgement**

```
[n][ ][Set ID][ ][OK/NG][0][d][Data][x]
```

\* This feature may not be supported in certain models.

**83. Screen Video Freeze (Command: k x)**

Turns on/off the video freeze function.

**Transmission**

```
[k][x][ ][Set ID][ ][Data][Cr]
```

Data 00: Turns on the freeze function.  
01: Turns off the freeze function.

\* Available in single input mode.

**Acknowledgement**

```
[x][ ][Set ID][ ][OK/NG][Data][x]
```

\* This feature may not be supported in certain models.

**84. Wireless Wake-on-LAN (Command: s n, 90)**

Sets Wireless Wake-on-LAN.

**Transmission**

```
[s][n][ ][Set ID][ ][9][0][ ][Data][Cr]
```

Data 00: Off

01: On

**Acknowledgement**

```
[n][ ][Set ID][ ][OK/NG][9][0][Data][x]
```

\* This feature may not be supported in certain models.

**85. OSD Display (Command: k l)**

Selects the desired OSD Display option.

**Transmission**

```
[k][l][ ][Set ID][ ][Data][Cr]
```

Data 00: No (Off)

01: Yes (On)

**Acknowledgement**

```
[l][ ][Set ID][ ][OK/NG][Data][x]
```

\* This feature may not be supported for certain models.

**86. UPnP Mode (Command: s n, 9c)**

Selects the desired UPnP mode option.

**Transmission**

```
[s][n][ ][Set ID][ ][9][c][ ][Data][Cr]
```

Data 00: Off

01: On

**Acknowledgement**

```
[n][ ][Set ID][ ][OK/NG][9][c][Data][x]
```

\* This feature may not be supported for certain models.

\* If UPnP Mode is changed, a reboot will occur.





INSTALLATION MANUAL

LG Digital

Signage

(MONITOR SIGNAGE)

Please read this manual carefully before operating your set and retain it for future reference.

webOS 2.0

# TABLE OF CONTENTS

## ACCESSING INSTALLATION MENU .....4

## INSTALLATION MENU .....5

### - Signage Setup Menu.....5

Power On Status

IR Operation

Local Key Operation

Wake On LAN

LAN Daisy Chain

No Signal Power Off (15 Min)

Auto Power Off

Beacon

DPM

DPM Wakeup Control

Baudrate (9600/115200)

OSD Portrait Mode (Off, 90, 270)

Power On Delay (0 ~ 250)

Check Screen

Digital Audio Input

Speaker

USB Auto Playback

Set ID

PM Mode

Interface Selection

OPS Power Control, OPS/PC Power Control

Master/Slave Mode

Sync Mode

Content Rotation

Aspect Ratio(Rotation)

Intelligent Auto

Studio Mode

Pivot Mode

Scan Inversion

White Balance

Applications

Crestron

Factory Reset

Status Message

SIMPLINK Setup

Multi-screen Resolution

Guide to Using Content Rotation/Pivot Mode/

Scan Inversion

### - USB Cloning Menu ..... 16

Send To USB

Receive From USB

Logo Image Download

- Password Change Menu .....	16	- Server Menu .....	23
- Tile Mode Menu .....	17	Set Automatically	
Row (1-15)		Server IP	
Column (1-15)		Server Status	
Tile ID (1-225)		Link Server IP	
Natural		Link Server Port	
Reset		Link Server Status	
- Fail Over Menu .....	19	- Lock Mode Menu .....	24
Off		USB	
Auto		OSD	
Manual		Reset to Initial Settings	
- ISM Method Menu .....	20	WiFi	
Mode			
Repeat			
Wait			
Duration			
Action Cycle			
Bar Image			
Bar Color			
Transparency			
Direction			
Bar Image Download			
User Image Download			
User Video Download			
* How to reset or delete downloaded bar images/user images/user videos			

# ACCESSING INSTALLATION MENU

- 1 Press and hold the SETTINGS button for 5 seconds.

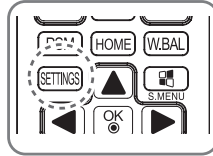

- 2 When Input ID (The top right corner ) is displayed, enter your password.  
(The default value is 0, 0, 0, 0 → )
- 3 When the Installation Menu is displayed, select the desired option.
  - Signage Setup
  - USB Cloning
  - Password Change
  - Tile Mode
  - Fail Over
  - ISM Method
  - Server
  - Lock Mode

## NOTE

- Images in the manual may look different from the actual product.

# INSTALLATION MENU

## NOTE

- Some features described in the Installation manual may not be supported in certain models.

## Signage Setup Menu

Use this menu to configure the digital signage after installation.

### Power On Status

- You can select the operating status of the monitor when the main power is switched on.
- You can select from among PWR, STD, and LST.
- PWR sets the status of the monitor to On whenever the main power is switched on.
- STD sets the status of the monitor to Standby when the main power is switched on.
- LST sets the status of the monitor back to its previous status.

### IR Operation

- If you set IR Operation to Normal, you can use the remote control.
- If you set IR Operation to Power Key Only, you can only use the Power Key.
- If you set IR Operation to Block All, you cannot use the remote control. (Power On feature is available.)

### Local Key Operation

- If you set Local Key Operation to Normal, you can use the Local Key.
- If you set Local Key Operation to Power Key Only, you can only use the Power Key.
- If you set Local Key Operation to Block All, you cannot use the Local Key. (Power On feature is available.)

### Wake On LAN

- You can set whether to use the Wake On LAN feature.
- You can set this option to On or Off.
- If you set this option to On, the Wake On LAN feature is enabled and you can turn on the product remotely via LAN.
- If you set this option to Off, the Wake On LAN feature is disabled.

### LAN Daisy Chain

- LAN Daisy Chain forms a daisy chain of LAN ports so that even if you connect only one monitor set to a network, the other sets in the daisy are connected to the network.
- The first set in the daisy chain must be connected to a network through a port that is not being used for the daisy chain.

## No Signal Power Off (15 Min)

- You can choose whether to use the 15 Min Force Off feature.
- You can set this option to On or Off.
- If you set this option to On, the product turns off when it has remained in No Signal status for 15 minutes.
- If you set this option to Off, the 15 Min Force Off feature is disabled.
- Set this option to Off when you use the product for a long period of time.

## Auto Power Off

- You can choose whether to use the 4 Hours Off feature.
- You can set this option to 4 Hours or Off.
- If you set this option to 4 Hours, the product turns off when you have not pressed any buttons on the remote control for 4 hours.
- If you set this option to Off, the 4 Hours Off feature becomes disabled.
- Set this option to Off when you use the product for a long period of time.

## Beacon

- Enables BLE Beacon, one of Bluetooth 4.0's features.
- Beacon Mode (on/off toggle): Enables the Beacon feature.
- Beacon UUID (hex): Sets the universally unique identifier (UUID) that will be used for Beacon. A UUID consists of 32 digits, and each digit has a hexadecimal value (0–FF) converted from a decimal number ranging from 0 to 255.
- Major (0–65535): Sets the main category value that matches the UUID.
- Minor (0–65535): Sets the subcategory value that matches the Major value.
- OK: Confirmation button to apply the four values above once they are set.
- Some models do not support background scanning services in iOS.

## DPM

- You can configure the DPM (Display Power Management) function.
- Off: you can set this option to Off, 5 sec./10 sec./15 sec./1 min./3 min./5 min./10 min.
- If this option is not set to Off, the monitor set enters the DPM mode when there is no input signal.
- If you set this option to Off, the DPM function is disabled.
- In the cases below, 5 sec. and 10 sec. options will be disabled for DPM. If DPM is already set to 5 sec. or 10 sec., it will be changed to 15 sec.
  - When USB Auto Playback is set to Photo or Movie
  - When Fail Over is set to Auto or Manual
- If you set this option to 10 sec. or less, the monitor set enters the DPM mode before automatic play of SuperSign contents.

## DPM Wakeup Control

- Turns on the monitor set according to the digital signal processing of the connected DVI/HDMI port.
- Setting this option to Clock only checks for the signals from the digital clock. If there is a clock signal, the monitor set is turned on.
- Setting this option to Clock+DATA turns on the monitor set only when there are both digital clock signal and data signal inputs.

## Baudrate (9600/115200)

- You can change the RS-232 communication speed for controlling your monitor.
- You can choose 9600 or 115200.
- If you set this option to 9600, the RS-232 communication speed is set at 9600 bps.
- If you set this option to 115200, the RS-232 communication speed is set at 115200 bps.

## OSD Portrait Mode (Off, 90, 270)

- This feature allows you to rotate the OSD clockwise.
- You can set this feature to Off/90/270.
- If you set this feature to Off, the feature is disabled.
- If you set this feature to 90, the OSD rotates 90 degrees clockwise. In this case, the mouse cannot be used.
- If you set this feature to 270, the OSD rotates 270 degrees clockwise. In this case, the mouse cannot be used.
- Depending on the model, you can set this feature to Off/On. If you set this feature to On, the OSD rotates 90 degrees clockwise.
- The set must be restarted for the changed settings to be applied in some models.

## Power On Delay (0 ~ 250)

- This feature delays power on in order to prevent overload when multiple monitor sets are turned on simultaneously.
- You can set the delay interval in the range of 0 to 250 seconds.

## Check Screen

- The Check Screen feature judges whether there are abnormalities at the edges of the screen. R, G, and B OSDs are formed on the screen at one second intervals and an RGB Sensor tests the areas.
- If set to On, the Check Screen feature is enabled.
- If set to Off, the Check Screen feature is disabled.
- If Portrait mode or Pivot mode is set to On, Check Screen is changed to Off and disabled.

## Digital Audio Input

- HDMI/DISPLAYPORT/OPS: You can hear the sounds of the digital signals carried by HDMI, DISPLAYPORT, or OPS through the monitor speakers.
- Audio In: you can hear sounds through the monitor speaker by connecting HDMI, or OPS or DISPLAYPORT ports to the Audio In port.
- If Digital is selected in DVI-D when using OPS/HDMI3/DVI-D or OPS/DVI-D input, there will be no sound.
- Models that do not support internal speakers require external speakers.

## Speaker

- If you set this option to On, you can hear sounds through the monitor speaker. (\* The monitor speaker is sold separately.)
- If you set this option to Off, you cannot hear sounds through the monitor speaker.

## USB Auto Playback

- This is a feature that auto-plays photos and videos when a USB device is connected. You can view photos and videos without manually selecting the View Photos/Movies menu. However, this feature is unavailable while the SuperSign contents are played.
- If you select Movie for USB Auto Playback, then the video files in the top level folder on the USB device will automatically play in sequence. When switched on, Signage automatically searches and plays video files from a USB.
- If you select Photo for USB Auto Playback, then the image files in the top level folder on the USB device will automatically play in sequence. When switched on, Signage automatically searches and plays photos from a USB.

## Set ID

- Set ID (1 ~ 1000) : When several products are connected for display, you can assign a unique Set ID No. to each product. Assign numbers ranging from 1 to 1000 and exit the option. You can control each product separately by using the Set ID you assigned to each product.
- Auto Set ID : Automatically assigns a unique set ID number to each set when several products are connected for display.
- Reset Set ID : You can reset the Set ID of the product to 1.

## PM Mode

- Power Off : Normal DC off status.
- Sustain Aspect Ratio : Normal DC off status except that Switching IC stays on. On certain models, this applies only to a specific input mode (DisplayPort) and has the same effect as Screen Off Always in other input modes.
- Screen Off : Automatically changes to Screen Off status when entering the DPM mode, Auto Off (15 mins, 4 hours), or Abnormal Shut Down.
- Screen Off Always : Automatically changes to Screen Off status when entering the DPM mode, Auto Off (15 mins, 4 hours), Off Timer, Abnormal Shut Down, or when there is input from the remote control's Power button or the monitor's Off button.
- To change the screen from Off to On status, there must be input from the remote control's Power or Input button, or the monitor's On button.

## Interface Selection

- You can set communication with the connected OPS.
- DISPLAY : Enables communication with external devices via the serial port.
- OPS : Enables communication via the OPS connected to the product.

## OPS Power Control, OPS/PC Power Control

- You can control the power of the OPS.
- Disable: Disables the OPS Power Control.
- Sync (on) : Synchronizes the power status of the monitor and the OPS only when monitor is on.
- Sync (on/off) : Always synchronizes the power status of the monitor and the OPS.

## Master/Slave Mode

- Master/Slave Mode: Syncs the products to the time and content of one product. These monitors can be set to Master or Slave. When multiple monitors are connected by RS-232C, only one monitor should be set to Master mode for this feature to work properly.
- Time Sync : To set Time Sync to On, the current time of the master monitor is sent to multiple slave monitors connected by RS-232C to sync the time. The monitors are synced every hour after the initial sync when Time Sync was set to On. (If any change occurs, there is an initial sync, and then the sync continues every hour.)
- Contents Sync : To set Content Sync to On, the content of the master monitor is sent to multiple slave monitors connected by RS-232C to sync content. All monitors must have Content Sync set to On with a single video or image for this feature to work properly. This feature supports content types only. Schedule types are not supported.

## Sync Mode

- Syncs the products to the time and content of one product.
- Off: Sync is disabled.
- RS232C: Syncs multiple monitors connected via RS-232C.
  - Master/Slave: These monitors can be set to Master or Slave. Only one monitor should be set to Master mode for this feature to work properly.
  - Time Sync: When Time Sync is set to On, the current time of the Master monitor is sent to multiple Slave monitors connected via RS-232C to sync the time. The monitors are synced every hour after the initial sync when Time Sync was set to On. (If any change occurs, there is an initial sync, and then the sync continues every hour.)
  - Contents Sync: When Contents Sync is set to On, the Contents of the Master monitor are sent to multiple Slave monitors connected via RS-232C to sync the Contents. This feature is only available for the monitors with Contents Sync set to On and operates normally with a single video or image in the Contents.
- Network: Syncs monitors connected to the same network. The monitor that authorized the SYNC NOW button becomes the Master.
  - How many connected screens: Enter the number of Slaves. A number from 1 to 225 can be entered and the default value is 1.
  - Select storage device: You can select Internal Memory or USB device.
  - Select the file name: Up to 10 files can be selected from the List of files in the selected device. Selecting the files will activate the SYNC NOW button at the top and make the next step available.
  - Only MP4 files are supported, and all files must be located in the SyncPlay folder in the root directory of the device.
  - Before using Network Sync, set the proxy server settings to Off.

- UPnP: Opens or blocks UDP port 1900, which is used for UPnP.
  - The default is On. Setting this to Off blocks UDP port 1900, making the UPnP function unavailable.
  - If this is set to Off, the 'Network' item of Sync Mode becomes inactive.
  - If this is set to Off and Sync Mode was set to 'Network', Sync Mode is switched to 'Off' and the 'Network' item becomes inactive.
  - If the UPnP value is changed, the function is not applied without a reboot.

## Content Rotation

- Rotates the image 90 or 270 degrees clockwise.
- It is recommended that you use content designed to be used in Portrait mode.
- As for ARC, setting Content Rotation to On (90 or 270) adjusts the size of a video to the full screen size.
- With WiDi, it is recommended that you set Aspect Ratio to Original if you intend to use Content Rotation. If you set Aspect Ratio to Full, the displayed position of the mouse pointer may not be accurate.
- Image quality degradation is not a product issue when setting Content Rotation using external input.

## Aspect Ratio(Rotation)

- Selects an aspect ratio option that will be applied to Content Rotation. (Original/Full)

## Intelligent Auto

- Adjusts the size, position, and phase of the monitor's screen automatically at the recognized resolution. This feature is available only in RGB input mode.

## Studio Mode

- Outputs the images with a lower color temperature.
- You can set this feature to On or Off.
- Setting this feature to On lowers the color temperature of the images.

## Pivot Mode

- This feature allows you to rotate the screen 180 degrees.
- Both the input signal and OSD are rotated.
- You can set this feature to On or Off.
- If you set this feature to Off, the feature is disabled.
- If you set this feature to On, the screen rotates 180°.
- If any changes are made, they are applied after reboot.

## Scan Inversion

- This feature reduces the level differences of displayed images whose top and bottom adjoin each other during high-speed image output.
- You can set this feature to On or Off.
- Setting this feature to On scans the image from the bottom to the top to minimize level differences. The displayed image will be inverted vertically and horizontally.
- We recommend that you use Scan Inversion together with Pivot mode.

## White Balance

- Adjusts the R-Gain, G-Gain, B-Gain, and Backlight values.
- Reset: Resets the White Balance value.

## Applications

- Adds/deletes applications in the Launcher bar.
- We recommend that if you are to remove the Screen Share app from the home launcher by unchecking the Screen Share item, you should reboot your system after removal.
- If you set Content Rotation or OSD Portrait Mode to On, the SuperSign EZ app will be deleted from the launcher and the SuperSign EZ item will be disabled.

## Crestron

- This function allows synchronization with an application provided by Crestron.
- Server: This menu sets the IP for the network connection with the server (equipment provided by Crestron).
- Port: This menu sets the port for the network connection with the server. The default port number is 41794.
- IP ID: This menu sets a unique ID for synchronizing with the application.

## Factory Reset

- You can reset the product to factory settings.

## Status Message

- Sets up a feature that sends the status of Signage to users' email addresses.
- The administrator can set Status Message to On or Off.
- Messaging Period: Sets a time interval to send messages. You can select either When Failure Status or Weekly.
- Select Date: Available if you have set Messaging Period to Weekly. Select your desired day of the week for message transmission.
- Select Time: Available if you have set Messaging Period to Weekly. Select your desired time for message transmission.
- User E-mail Address: Enter the sender's email address.
- Type: Fixed as POP3.
- Sending Server (SMTP): Enter the mail server address of POP3.
- ID: Enter the mail server's user ID.
- Password: Enter the mail server's user password.
- Receiver E-Mail Address: Enter the recipient's email address for status messages.
- If the status regarding any of the following items changes or becomes abnormal, a status message can be sent.
  - 1. Temperature: If the monitor set reaches a dangerous temperature, its current temperature is recorded, and an email containing such information is sent.
  - 2. Validity of the temperature sensor: An email is sent if there is no temperature sensor connected, if the communication status of the temperature sensor is unknown, or if the information provided by the chip provider is abnormal.
  - 3. Network Status (Wireless/Wired): An email is sent when the network's connection status is changed. The maximum number of network status changes that can be saved is limited to 50. The saved value is reset once the power turns off.
  - 4. RGB Sensor: An email is sent if the execution of Check Screen by the RGB sensor fails.
  - 5. No Signal Check: Checks whether there is a signal. If there are no signals for more than 10 seconds, an email is sent.
  - 6. Local Contents Schedule: An email is sent if it becomes impossible to play content between the start time and end time of the playback schedule registered in Signage. However, this does not apply when termination was made using the remote control.
  - 7. SuperSign Schedule: An email is sent if it becomes impossible to play content between the start time and end time of the playback schedule distributed to SuperSign. However, this does not apply when termination was made using the remote control.
  - Some of the features above may not be supported on certain models.
- Only SMTP Port 25, 587 is supported; Naver is not supported.

## SIMPLINK Setup

- When the SIMPLINK Setup is set to On, you can use the SIMPLINK provided by LG Signage.
- Device ID: Sets the ID of the device connected via CEC wiring. You can choose a value between 'All' and 'E'.
- StandBy: Sets the scenarios for sending and receiving the OpStandBy (0x0c) command. Detailed scenarios are as follows:

	Send	Receive
Send Only	O	X
Receive Only	X	O
All	O	O

## Multi-screen Resolution

- This feature allows you to change the recommended resolution for the connected device according to the selected split screen mode in Multi-screen. You can set the recommended resolution to change automatically or be fixed at the recommended resolution according to a specific split screen mode. The screen may flicker when changing settings.
- Fit to Screen: The recommended resolution for the connected device automatically changes to the optimal resolution for the selected split screen mode in Multi-screen. If you select a resolution other than the recommended resolution for the connected device, the selected resolution remains fixed, even when the split screen mode is changed.
- On some graphics cards capable of both HDTV signal output and PC signal output, the HDTV output resolution is adjusted to 1080p or lower, and the PC output resolution is adjusted for two, three, or four screens automatically.
- For some graphics cards and operating systems, it may be necessary to set the recommended resolution for each split mode.
- One Screen: The recommended resolution for the connected device is set to the optimal resolution for a single screen. When using Multi-screen, the screen may not work properly. To use the device in the Multi-screen environment, the settings must be changed according to the selected mode. To run the multi-screen app, the resolution of the connected device must be set to the supported resolution of the multi-screen mode or lower.
- Two Screens: The recommended resolution for the connected device is set to the optimal resolution for twoscreen split screen mode in Multi-screen.
- Three Screens: The recommended resolution for the connected device is set to the optimal resolution for threescreen split screen mode in Multi-screen.
- Four Screens: The recommended resolution for the connected device is set to the optimal resolution for fourscreen split screen mode in Multi-screen.

## Guide to Using Content Rotation/Pivot Mode/Scan Inversion

If you have enabled both Pivot Mode and Scan Inversion, the logo screen that appears when the monitor is turned on will be inverted vertically as well as horizontally.

### [Portrait installation setting]

In the original image or in Pivot mode, you can turn the image into a portrait image using Content Rotation.

When installing the display rotated 90 degrees: Set Content Rotation to 270.

When installing the display rotated 270 degrees: Set Content Rotation to 90.

Example) When installing the display rotated 90 degrees

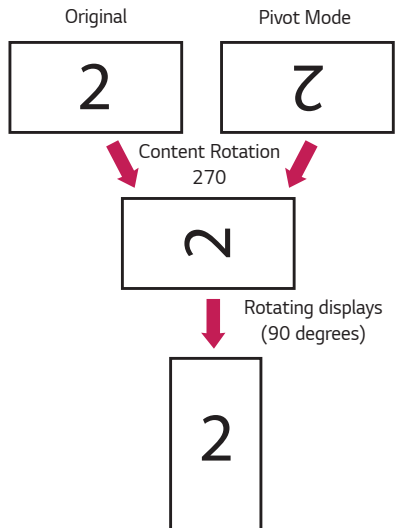

**[Video wall installation setting]**

You can implement a landscape and portrait video wall using Pivot mode, Scan Inversion, and Content Rotation.

Example) Tile mode 2 x 2

\* Landscape video wall

- Set Scan Inversion and Pivot Mode to On for the displays in row 2.

\* Portrait video wall

- Set Scan Inversion to On and set Content Rotation to 90 for the displays in column 1.
- Set Content Rotation to 270 for the displays in column 2.

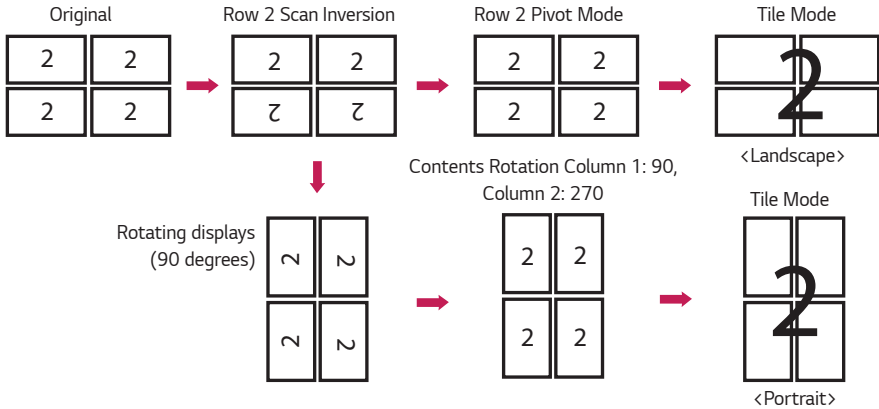

## USB Cloning Menu

You can copy the product settings to other sets.

### Send To USB

- You can save the current settings in file format to a USB device.
- Select the file name and press the OK button to complete
- You cannot save the following items: HDMI ULTRA HD Deep Color, Advanced settings under Picture, Clock, Power On Delay, Set ID, items under Network, White Balance, Tile ID, Signage setup menu - master/slave mode, timer sync, all menus in the ISM method menu (except for mode, repeat, wait, and duration), and menu items in My Media.

### Receive From USB

- You can import configuration files from a USB device and change the settings for the current set.
- Using a settings file from a different model may not work properly on this product.
- When import is complete, the power reboots after 5 seconds.

### Logo Image Download

- You can download and apply the boot images.
- The image you want to apply must be stored in the LG\_MONITOR folder at the top level of a USB device.
- When downloading is complete, the set reboots and the boot image will be applied.



### CAUTION

- To use the Configuration Cloning function, be sure to use a USB storage device formatted using the FAT32 file system. If the USB storage device has been formatted with another file system, it may not work correctly.

## Password Change Menu

You can change your password in the Installation menu.

You can change your password for security purposes. Enter a new 4-digit password. Enter the same password again in Confirm Password for confirmation.

## Tile Mode Menu

You can configure the integrated screen in the same way as each screen is configured.

To use this function

- Must be used with multiple monitors.
- Must be operated by connecting to each display via a distributor or DP daisy chain.
- Tile mode: row x column (r = 1 to 15, c = 1 to 15)
- 15 x 15 available

### Row (1-15)

- Set the number of Tile rows.

### Column (1-15)

- Set the number of Tile columns.

### Tile ID (1-225)

- Set an ID for the Tile.
- The ID you selected will be displayed on the screen.

### Natural

- For more natural display, the image is partly omitted to account for the distance between the screens.

### Reset

- Resets the Tile Mode option.
- When Tile is reset, Tile settings will be reset to 2 x 2.



### NOTE

- If Tile Mode is enabled, Smart Energy Saving will be disabled to provide the same picture quality as other displays.
- Only 4 x 4 is available for certain models. (for 1080p or higher)

### Tile Mode

This monitor can be tiled with additional monitors to create a large tiled display.

#### Off

When the Tile Mode option is disabled

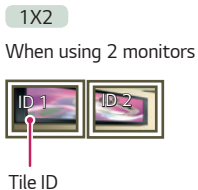

#### 2X2

When using 4 monitors



#### 3X3

When using 9 monitors



#### 4X4

When using 16 monitors



#### 5X5

When using 25 monitors



### Tile Mode - Natural mode

When active, the part of the image that would normally be displayed in the gap between the monitors is omitted.

Before



After



## Fail Over Menu

The input source with the highest priority will be selected.

### Off

- The Auto-Fail Over feature is disabled.

### Auto

- The input source changes according to the specified order. When several input sources are found, the input source with the highest priority will be selected.
- Priority  
Case 1) 1. HDMI, 2. DVI-D, 3. DISPLAYPORT, 4. OPS, 5. RGB, 6. Internal Memory  
Case 2) 1. HDMI1, 2. HDMI2, 3. OPS/HDMI3/DVI-D or OPS/DVI-D, 4. DP, 5. Internal Memory

### Manual

- The input source changes according to the specified order. When several input sources are found, the input source with the highest priority will be selected.
- You can set Priority 1 - Priority 6.



### NOTE

- If the input switches to the Internal Memory, USB, or SD Card due to Fail Over, the content, videos, or images in the storage device will be played.
- If there is content (cts or cpls) located in the fail\_over (FAIL\_OVER) folder in the root directory of the storage device, the content will be played first.
- If there is no content, the videos or images stored in the root directory of the storage device will be played.
- If there are both video files and image files in the same folder, then only the video files will be played.
- Content distributed by SuperSign will be saved in the folder named 'normal' in the internal memory. Therefore, content distributed by SuperSign will not be automatically played due to Fail Over.
- The number of priorities may vary depending on the model.

## ISM Method Menu

If a still image is displayed on the screen for an extended period of time, image sticking can occur. The ISM method is a feature that prevents image sticking.

### Mode

- Selects the desired ISM Method mode.
- Normal : Disables the ISM method.
- White Wash : Displays a white pattern to remove image sticking.
- Color Wash : Alternately displays a white pattern and a color pattern to remove image sticking.
- User Image : Plays your desired photos.
- User Video: Plays your desired video.
- Inversion: Inverts screen colors to remove image sticking. (This option is disabled when the current input source is No Signal.)
- Orbiter: Moves the position of the screen as much as three pixels at a time in a certain order to prevent image sticking. (This option is disabled when the current input source is No Signal.)
- Washing Bar: Displays a bar on the screen to make the image move smoothly. You can download your desired image and display it on the bar.

### Repeat

- Off, just 1 time: If you select the desired mode and press DONE, ISM operates immediately.
- On: If the screen remains still for a specified wait time, ISM operates for the specified duration time.

### Wait

- You can set the time between 1–24 hours.
- This option is available only when you have set Repeat to On.
- The ISM feature starts when the image freezes for a specified period of time.

### Duration

- You can select from among 1–10 mins/20 mins/30 mins/60 mins/90 mins/120 mins/180 mins/240 mins.
- This option is available only when you have set Repeat to On.
- ISM operates for the specified time.

### Action Cycle

- You can select from among 1–10 mins/20 mins/30 mins/60 mins/90 mins/120 mins/180 mins/240 mins.
- This option is available only when you have selected Inversion or Orbiter.
- Orbiter: Moves the position of the screen at specified intervals.
- Inversion: Inverts the screen color at specified intervals.

## Bar Image

- Off: Displays a bar with a fixed resolution of 300 x 1080, then moves the bar.
- On: Displays and moves an image downloaded by the user. The image is displayed with a fixed height of 1080 and the same width as downloaded. However, if the width of the image is below 300, it will have a fixed value of 300.
- This option is available only when you have selected Washing Bar.
- If you have downloaded only one image, the bar is moved and the image is displayed alone.
- If you have downloaded multiple images, up to four images are displayed in sequence per cycle.

## Bar Color

- You can choose from six colors: red, green, blue, white, black, and gray.
- This feature is only applicable when Bar Image is set to Off.
- This option is available only when you have selected Washing Bar.

## Transparency

- Off: Displays the bar opaquely.
- On: Displays the bar translucently. (Transparency: 50 %)
- This option is available only when you have selected Washing Bar.

## Direction

- Left To Right: The bar is moved from left to right.
- Right To Left: The bar is moved from right to left.
- This option is available only when you have selected Washing Bar.

## Bar Image Download

- To download an image, the image file must be located under the folder titled "ISM" on your USB drive.
- Make sure to delete the old images stored in the internal memory before downloading a new image file.
- Supported image file types: "BMP", "JPG", "JPEG", "PNG", "GIF"
- You can download up to four images. (Resolution: 1920 x 1080 or lower)
- If there are no images, or if the existing images have been deleted, the default image is used. (The default image is an image of a white bar.)
- This option is available only when Bar Image is On.

## User Image Download

- To download an image, the image file must be located under the folder titled "ISM" on your USB drive.
- Make sure to delete the old images stored in the internal memory before downloading a new image file.
- Supported image file types: "BMP", "JPG", "JPEG", "PNG", "GIF"
- You can download up to four images. (Resolution: 1920 x 1080 or lower)
- If there are no images, or if the existing images have been deleted, the default image is used. (The default image is a white background image.)
- This option is available only when you have selected User Image.

## User Video Download

- To download a video, the video file must be located under the folder titled "ISM" on your USB drive.
- Make sure to delete the old contents stored in the internal memory before downloading a new video file.
- Supported video file types: "MP4", "AVI", "FLV", "MKV", "MPEG", "TS"
- You can download up to one video.
- If there are no videos, or if the existing videos have been deleted, the default video is used. (The default video is a white background image.)
- This option is available only when you have selected User Video.

### \* How to reset or delete downloaded bar images/user images/user videos

- To reset, go to Installation > Signage Setup > Factory Reset.
- To delete, go to Internal Memory under My Media's Devices item and delete the desired downloaded content.

# Server Menu

## Set Automatically

- The monitor settings will be set automatically so that the SuperSign server can search it.

## Server IP

- This is a menu where you can set an IP address for the SuperSign server.

## Server Status

- Server Status displays the status of the connection between your monitor and the SuperSign server.
- Not connected - indicates that your monitor is not connected to the SuperSign server.
- Waiting for approval - indicates that your monitor is connected to the SuperSign server but not yet approved.
- Rejected - indicates that your monitor is connected to the SuperSign server but has been rejected.
- Connected - indicates that your monitor is connected to the SuperSign server and has been approved.

## Link Server IP

- This menu sets the IP address of the SuperSign Link Server.

## Link Server Port

- This menu sets the port of the SuperSign Link Server.

## Link Server Status

- Displays the status of the connection to the SuperSign Link Server.
- Not Connected: Not connected to the SuperSign Link Server.
- Waiting for Approval: Connected to the SuperSign Link Server but not approved.
- Connected: Connected to the SuperSign Link Server and approved.

## Lock Mode Menu

### USB

- You can prevent the use of USB devices.

### OSD

- You can prevent OSD from displaying.

### Reset to Initial Settings

- You can restore the initial settings with this feature.

### WiFi

- You can restrict the Wi-Fi settings.

