



OWNER'S MANUAL

IPS LED MONITOR

(LED Monitor*)

* LG LED Monitor applies LCD screen with LED backlights.

Please read this manual carefully before operating your set and retain it for future reference.

27HJ712C

TABLE OF CONTENTS

ON CLEANING	3
LICENSE	3
ASSEMBLY AND PREPARING	4
USING THE MONITOR	19
USER SETTINGS	23
TROUBLESHOOTING	38
PRODUCT SPECIFICATIONS	40

ON CLEANING

Recommended Cleaning Chemicals

- Isopropanol 100%
- Ethanol 70%
- Cidex® OPA
- 0.9% NaCl solution
- Biospot 500 ppm

How to Use Cleaner

- Prior to cleaning, turn off the monitor and remove the power cable.
- Soak a soft cloth in a recommended cleaner, then lightly rub the screen with no more than 1 N of force.
- The cleaner could cause serious damage if it leaks inside the monitor while cleaning.
- Do not clean the screen's LCD panel as it may be damaged. Clean the other parts of the monitor.
- Do not use benzene, thinner, acids or alkaline cleaners or other such solvents.
- Cleaning guidelines for displays must only be carried out by medical professionals (doctors or nurses) and must not be handled by patients.

LICENSE

Each model has different licenses. Visit www.lg.com for more information on the license.



The terms HDMI, HDMI High-Definition Multimedia Interface, HDMI Trade Dress and the HDMI Logos are trademarks or registered trademarks of HDMI Licensing Administrator, Inc.



VESA, VESA logo, DisplayPort compliance logo and DisplayPort compliance logo for dual-mode source devices are all registered trademarks of the Video Electronics Standards Association.



The SuperSpeed USB Trident logo is a registered trademark of USB Implementers Forum, Inc.

"DICOM® is the registered trademark of the National Electrical Manufacturers Association for its Standards publications relating to digital communications of medical information."

ASSEMBLY AND PREPARING

Product Composition

Please check whether all the components are included in the box before using the product. If there are any missing components, contact the retailer where you purchased the product. Note that the product and related components may look different from those shown here.

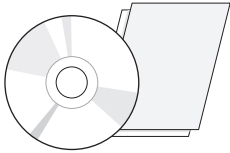

CD (Owner's Manual/ Software/
Guides)/ Cards

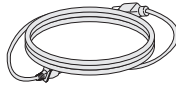

Power Cord

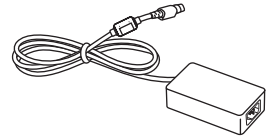

AC/DC Adaptor

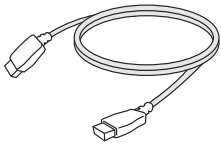

HDMI Cable

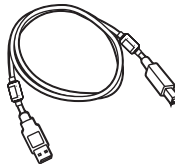

or

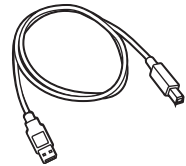

A-B type USB 3.0 Cable



DisplayPort Cable



Cable Holder

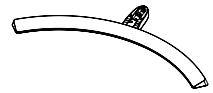

Stand Base

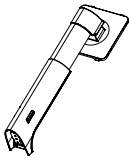

Stand Body



CAUTION

- Always use genuine LG components to ensure safety and product performance.
- The product warranty will not cover damage or injury caused by the use of unauthorized components.
- It is recommend that use the supplied components.
- If you use generic cables not certified by LG, the screen may not display or there may be image noises.



NOTE

- The components may look different from those illustrated here.
- Without prior notice, all product information and specifications contained in this manual are subject to change to improve the performance of the product.
- To purchase optional accessories, visit an electronics store or an online shopping site, or contact the retailer from which you purchased the product.
- The power cord provided may differ depending upon the region.

Supported Drivers and Software

Check the drivers and software supported by your product and refer to the manuals on the CD enclosed in the product package.

Drivers and Software	Installation Priority	27HJ712C
Monitor Driver	Recommended	0
OnScreen Control	Optional	0
Dual Controller	Optional	0
True Color Pro	Optional	0

- Required and Recommended: You can download and install the latest version from the enclosed CD or from the LGE website (www.lg.com).
- Optional: You can download and install the latest version from the LGE website (www.lg.com).



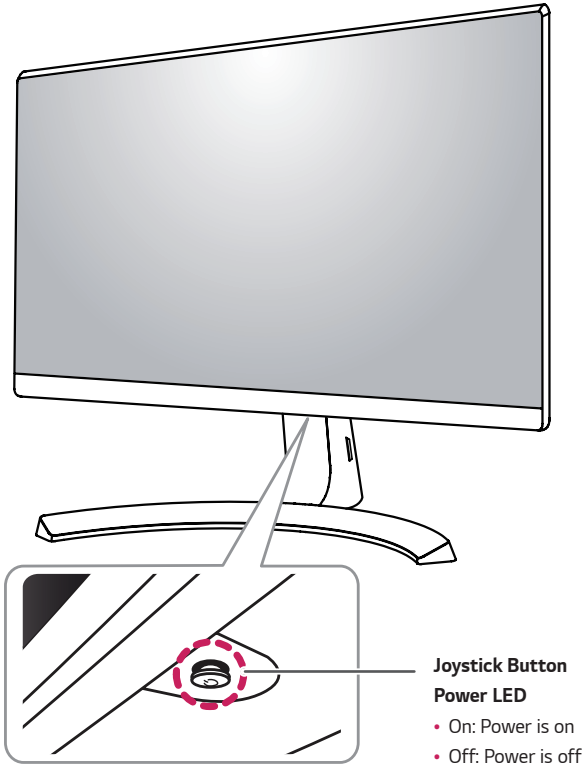

Component and Button Description



How to Use the Joystick Button

You can easily control the functions of the monitor by pressing the joystick button or moving it left/right with your finger.

Basic Functions

		Power on	Press the joystick button once with your finger to turn on the monitor.
		Power off	Press and hold the joystick button once with your finger to turn off the monitor.
		Volume Control	You can control the volume by moving the joystick button left/right.



NOTE

- The joystick button is located at the bottom of the monitor.

Input Connector

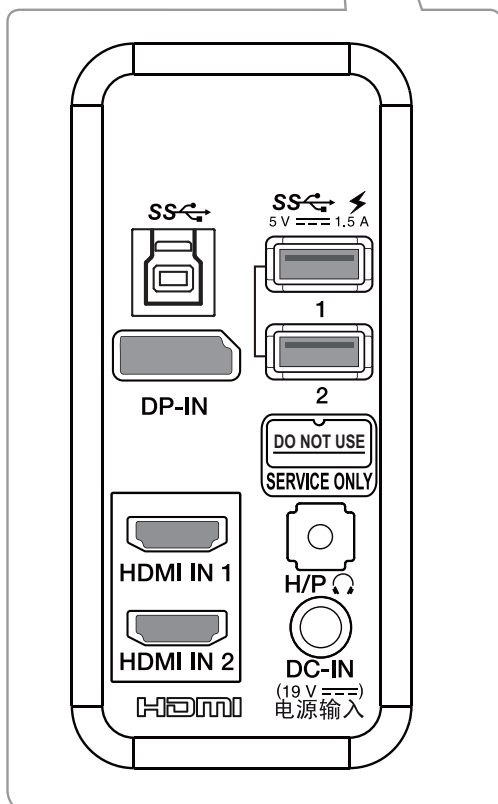
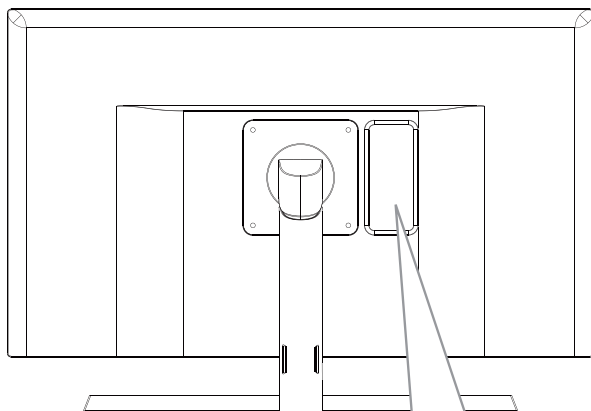

Moving and Lifting the Monitor

When moving or lifting the monitor, follow these instructions to prevent the monitor from being scratched or damaged and to ensure safe transportation regardless of its shape or size.

- It is advisable to place the monitor in the original box or packing material before attempting to move it.
- Before moving or lifting the monitor, disconnect the power cord and all cables.
- Hold the bottom and side of the monitor frame firmly. Do not hold the panel itself.

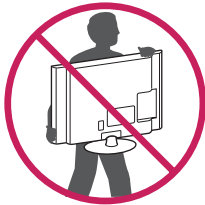
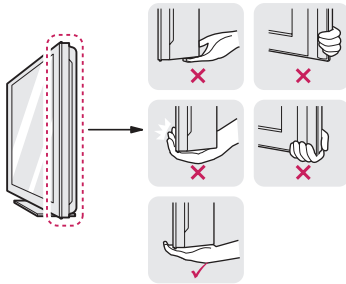

- When holding the monitor, the screen should face away from you to prevent it being scratched.
- When moving the monitor, avoid any strong shock or vibrations to the product.
- When moving the monitor, keep it upright, never turn the monitor on its side or tilt it sideways.

CAUTION

- As far as possible, avoid touching the monitor screen.
 - This may result in damage to the screen or some of the pixels used to create images.

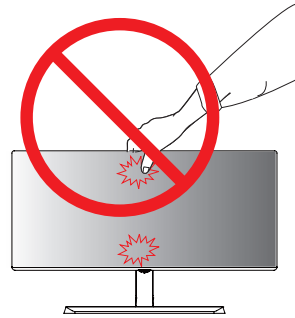

- If you use the monitor panel without the stand base, its joystick button may cause the monitor to become unstable and fall, resulting in damage to the monitor or human injury. In addition, this may cause the joystick button to malfunction.

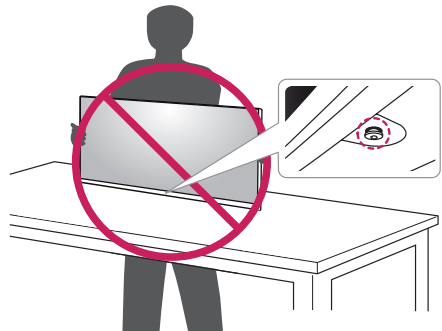

Installing the Monitor

Assembling the Stand base

- Illustrations in this document represent typical procedures, so they may look different from the actual product.

1

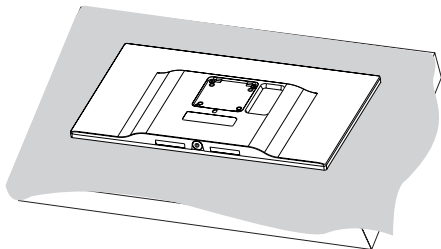

CAUTION

- To protect the screen from scratches, cover the surface with a soft cloth.

2

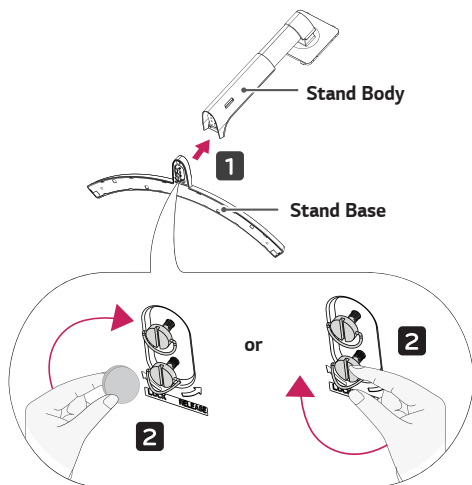

3

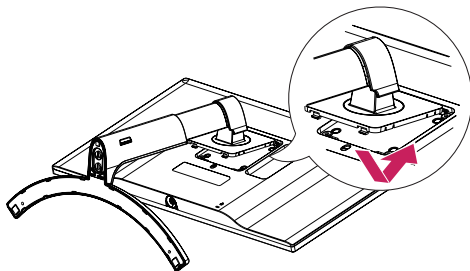

4

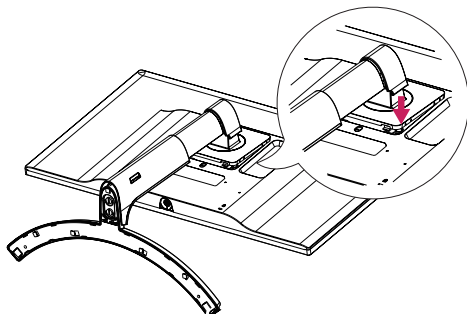

NOTE

- Press the stand until the button reaches the top.

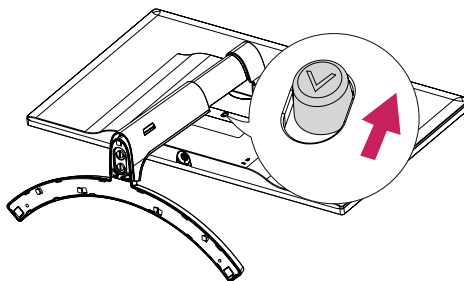



CAUTION

- Illustrations in this document represent typical procedures, so they may look different from the actual product.
- Do not apply foreign substances (oils, lubricants, etc.) to the screw parts when assembling the product. (Doing so may damage the product.)
- Applying excessive force when tightening screws may cause damage to the monitor. Damage caused in this way will not be covered by the product warranty.
- Do not carry the monitor upside down by just holding the base. This may cause the monitor to fall off the stand and could result in personal injury.
- When lifting or moving the monitor, do not touch the monitor screen. The force applied to the monitor screen may cause damage to it.



NOTE

- You can disassemble the stand in the reverse order of the assembly.

Arranging Cables

Arrange the cables using the cable holder as shown in the illustration.

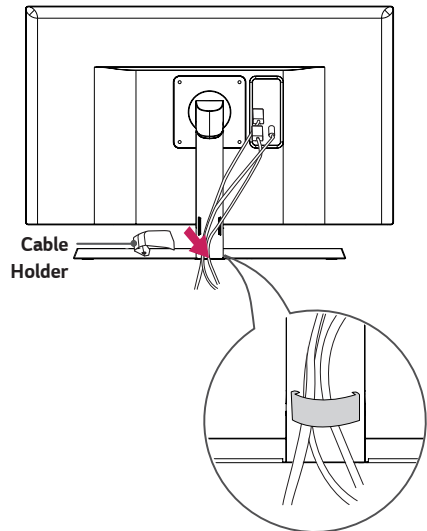

Installing on a Table

- 1 Lift the monitor and place it on the table in an upright position. Place at least 100 mm away from the wall to ensure sufficient ventilation.

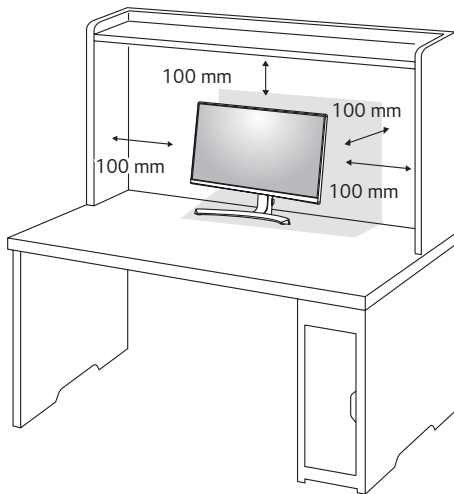

- 2 Connect the power adapter to the monitor and then plug the power cord into the wall outlet.

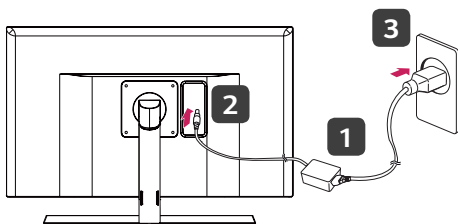

- 3 Press the joystick button on the bottom of the monitor to turn on the monitor.

CAUTION

- Unplug the power cord prior to moving or installing the monitor. There is risk of electric shock.

Cautions When Connecting Power Cord

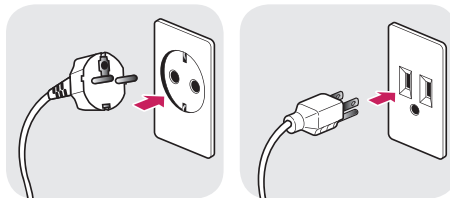

100-240 V ~

- Make sure to use the power cord that is provided in the product package and connect it to a grounded power outlet.
- If you need another power cord, please contact your local dealer or the nearest retail store.

Adjusting the Angle

- 1 Place the monitor in an upright position, mounted on the stand base.
- 2 Adjust the angle of the screen. The angle of the screen can be adjusted forwards or backwards for a comfortable viewing experience.

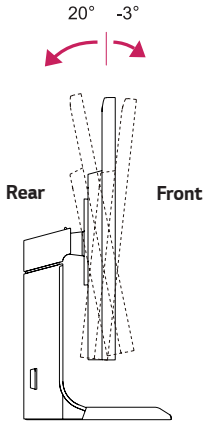

! WARNING

- To avoid injury to the fingers when adjusting the screen, do not hold the lower part of the monitor's frame as illustrated below.

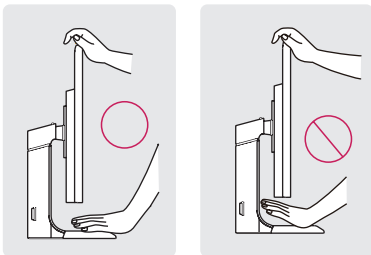

Adjusting the Stand Height

- 1 Place the monitor mounted on the stand base in an upright position.
- 2 Handle the monitor with both hands for safety.

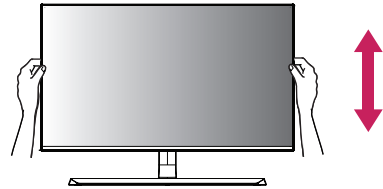

- 3 The height can be adjusted up to 110.0 mm.

110.0 mm

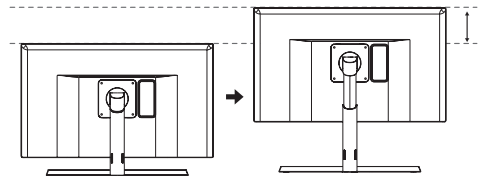

! WARNING



- Do not put your fingers or hand between the screen and the base (chassis) when adjusting the screen's height.

Pivot Feature

The pivot feature allows the monitor to rotate 90° clockwise.

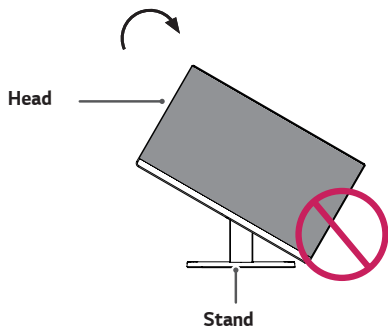

WARNING

- To avoid scratching the stand base, make sure that when rotating the monitor using the pivot feature, the stand does not make contact with the monitor.

1 Raise the monitor to the maximum height.

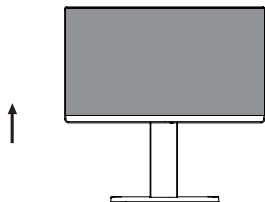

2 Adjust the angle of the monitor in the direction of the arrow as shown in the figure.

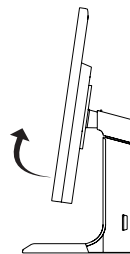

3 Rotate the monitor clockwise as shown in the figure.

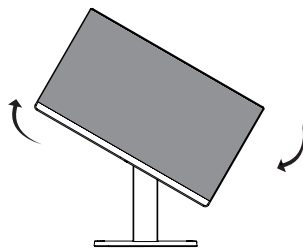

4 Complete the installation by rotating the monitor 90° as shown below.



! NOTE

- Auto Pivot feature of the display is not supported.
- The screen can be rotated easily using the screen pivot shortcut key provided with your Windows operating system. Note that some Windows versions and some graphics card drivers may use different settings for the screen pivot key or may not support the pivot key at all.
- Windows screen pivot shortcut keys
 - 0°: Ctrl + Alt + Up arrow key (↑)
 - 90°: Ctrl + Alt + Left arrow key (←)
 - 180°: Ctrl + Alt + Down arrow key (↓)
 - 270°: Ctrl + Alt + Right arrow key (→)

! WARNING

- Take care when rotating the monitor if the cable is connected.
- To avoid injury when rotating the display, do not place your fingers between the display and the stand base.

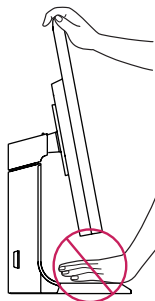

Using the Kensington lock

The Kensington security system connector is located at the back of the Monitor set.

For more information on installation and usage, refer to the Kensington lock owner's manual or visit the website at <http://www.kensington.com>.

Connect the Kensington security system cable between the Monitor set and a table.

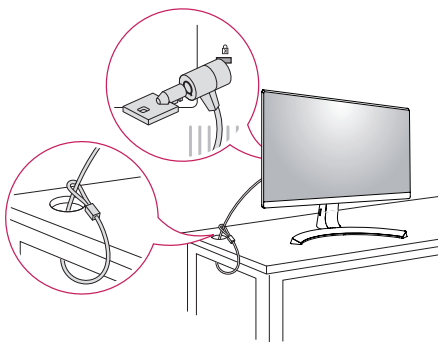

! NOTE

- The Kensington security system is optional. You can obtain optional accessories from most electronics stores.

Detaching the Stand Body

- 1 Place the monitor's screen face down. To protect the screen from scratches, cover the surface with a soft cloth.
- 2 Remove the stand from the monitor by pressing the button on the bottom center of the back of the monitor.

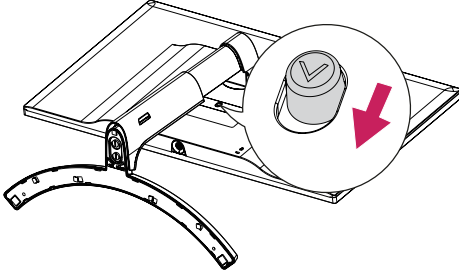

Installing the wall mount plate

This monitor supports the specification of the standard wall mount plate or compatible device.

- 1 Place the screen face down. To protect the screen from scratches, cover the surface with a soft cloth.
- 2 Using a screwdriver, remove the four screws at the back of the monitor.
- 3 Place the wall mount plate onto the monitor and align it with the screw holes.
- 4 Tighten the four screws to fix the plate to the monitor using a screwdriver.

NOTE

- The wall mount plate is sold separately.
- For more information on installation, refer to the wall mount plate's installation guide.
- Be careful not to use excessive force when mounting the wall mount plate, as this can damage the monitor's screen.

Installing on the Wall

Install the monitor at least 100 mm away from the wall and leave about 100 mm of space at each side of the monitor to ensure sufficient ventilation. Detailed installation instructions can be obtained from your local retail store. Alternatively, please refer to the manual for how to install and set up a tilting wall mounting bracket.

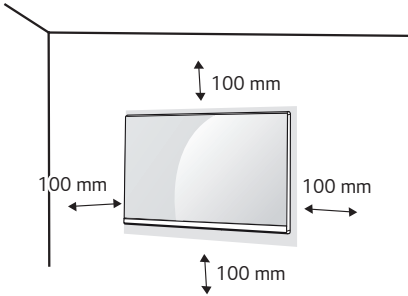

To install the monitor to a wall, attach a wall mounting bracket (optional) to the back of the monitor. Make sure that the wall mounting bracket is securely fixed to the monitor and to the wall.

- 1 If you use screw longer than standard, the monitor might be damaged internally.
- 2 If you use improper screw, the product might be damaged and drop from mounted position. In this case, LG Electronics is not responsible for it.

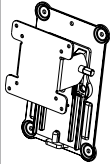
Wall Mount (mm)	100 x 100
Standard screw	M4 x L10
Number of screws	4
Wall Mount Plate (Optional)	RW120 

! NOTE

- Use the screws specified by the VESA standard.
- The wall mount kit includes the installation guide and all necessary parts.
- The wall mounting bracket is optional. The accessories can be purchased at your local retail store.
- The length of the screw may differ for each wall mounting bracket. Ensure the correct length screw is used.
- For more information, please refer to the user manual for the wall mounting bracket.



CAUTION

- Unplug the power cord before moving or installing the monitor to avoid electric shocks.
- Installing the monitor on the ceiling or on a slanted wall may result in the monitor falling off, which could lead to injury. Please use the genuine LG wall mounting bracket. For more information, contact your local retail store or a qualified installer.
- Applying excessive force when fastening screws may cause damage to the monitor. Damage caused in this way will not be covered by the product warranty.
- Use the wall mounting bracket and screws that confirm to the VESA standard. Damage caused by the use or misuse of inappropriate components will not be covered by the product warranty.
- Screw length from outer surface of back cover should be under 8 mm.

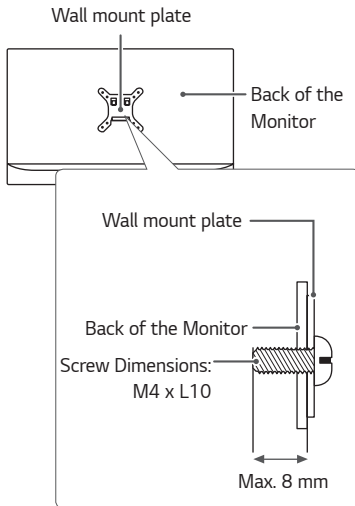

USING THE MONITOR

Connecting to a PC

- This monitor supports the *Plug and Play feature.

* Plug and Play: A feature that allows you to add a device to your computer without having to reconfigure anything or install any manual drivers.

HDMI connection

Transmits digital video and audio signals from your PC to the monitor. Connect your PC to the monitor using the HDMI cable as shown in the illustration below.

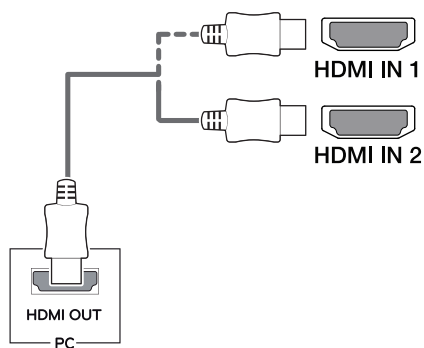

CAUTION

- Make sure to use the supplied HDMI cable of the product. Otherwise, this may cause the device to malfunction.
- Connecting your PC to the monitor using the HDMI cable may cause device compatibility issues.
- Using a DVI to HDMI / DP (DisplayPort) to HDMI cable may cause compatibility issues.
- Use a certified cable with the HDMI logo attached. If you do not use a certified HDMI cable, the screen may not display or a connection error may occur.
- Recommended HDMI cable types
 - High-Speed HDMI®/™ Cable
 - High-Speed HDMI®/™ Cable with Ethernet

DisplayPort Connection

Transmits digital video and audio signals from your PC to the monitor. Connect the monitor to your PC using the DisplayPort cable as shown in the illustration below.

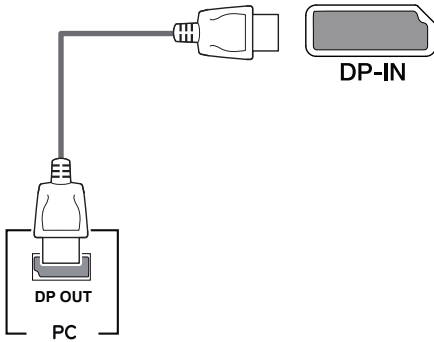

! NOTE

- There may be no video or audio output depending on the DP (DisplayPort) version of the PC.
- Make sure to use the supplied DisplayPort cable of the product. Otherwise, this may cause the device to malfunction.
- If you use generic cables not certified by LG, the screen may not display or there may be image noises.

Connecting AV Devices

HDMI Connection

HDMI transmits digital video and audio signals from your AV device to the monitor. Connect your AV device to the monitor using the HDMI cable as shown in the illustration below.

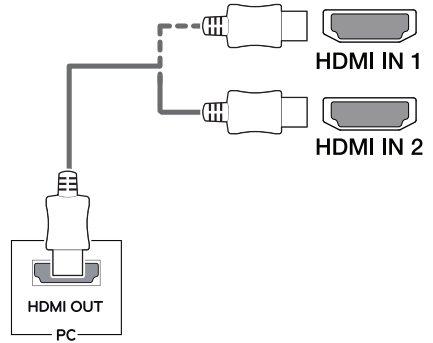

! NOTE

- Make sure to use the supplied HDMI cable of the product. Otherwise, this may cause the device to malfunction.
- Using a DVI to HDMI / DP (DisplayPort) to HDMI cable may cause compatibility issues.
- Use a certified cable with the HDMI logo attached. If you do not use a certified HDMI cable, the screen may not display or a connection error may occur.
- Recommended HDMI cable types
 - High-Speed HDMI^{®/TM} Cable
 - High-Speed HDMI^{®/TM} Cable with Ethernet

Connecting Peripherals

USB Cable connection - PC

The USB port on the product functions as a USB hub.

NOTE

- Make sure to install the most recent Windows OS service pack before using the product.
- Peripheral devices are sold separately.
- A keyboard, mouse, or USB device can be connected to the USB port.
- Go to **General > Quick Charge** to set **Quick Charge** to **On** or **Off**.
- The charging speed may vary depending on the device.

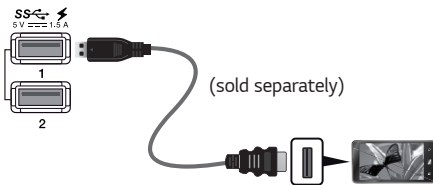

HDMI/DP (DisplayPort) connection

To use USB 3.0, connect the A-B type USB 3.0 cable of the product to the PC.

Peripheral devices connected to the USB IN port can be controlled from the PC.

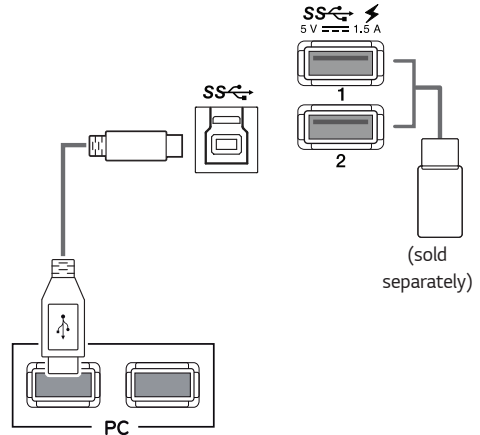

CAUTION

Cautions When Using a USB Device

- A USB device with an automatic recognition program installed, or that uses its own driver, may not be recognized.
- Some USB devices may not be supported or may not work properly.
- It is recommended to use a USB hub or hard disk drive with power supplied. (If the power supply is not adequate, the USB device may not be recognized properly.)

Connecting Headphones

Connect peripherals to the monitor via the headphones port. Connect as illustrated.

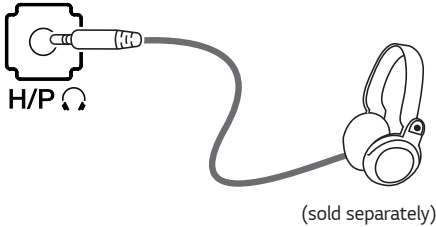

! NOTE

- Peripheral devices are sold separately.
- If you use angled earphones, it may cause a problem with connecting another external device to the monitor. Therefore, it is recommended to use straight earphones.



Angled



Straight

- Depending on the audio settings of the PC and external device, headphones and speaker functions may be limited.

Service only port

The port is used only for "Service".



USER SETTINGS

Activating the Main Menu

- 1 Press the joystick button on the bottom of the monitor.
- 2 Move the joystick up/down (▲/▼), and left/right (◀/▶) to set the options.
- 3 Press the joystick button once more to exit the main menu.

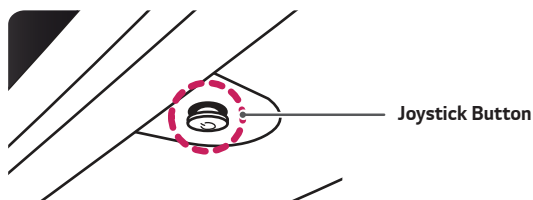

Button	Menu Status	Description
	Main menu disabled	Enables the main menu.
	Main menu enabled	Exits the main menu. (Holding down the button to turn off the monitor: You can turn off the monitor this way at any time, including when the OSD is on.)
	◀ Main menu disabled	Adjusts the monitor volume level.
	◀ Main menu enabled	Enters the Menu features.
	▶ Main menu disabled	Adjusts the monitor volume level.
	▶ Main menu enabled	Enters the Input feature.
	▲ Main menu disabled	Enables the main menu.
	▲ Main menu enabled	Enters the Picture Mode feature.
	▼ Main menu disabled	Enables the main menu.
	▼ Main menu enabled	Turns off the monitor.

Main Menu Features

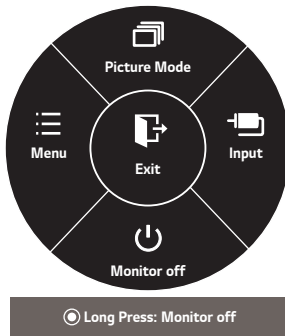

Main Menu	Description
Menu	Configures the screen settings.
Picture Mode	Optimizes the screen for picture mode.
Input	Sets input mode.
Monitor off	Turns off the monitor.
Exit	Exits the main menu.

User Settings

Menu Settings

- 1 To view the OSD menu, press the joystick button at the bottom of the monitor and then enter the **Menu**.
 - 2 Configure the options by moving the joystick up/down/left/right.
 - 3 To return to the upper menu or set other menu items, move the joystick to ◀ or pressing (Ⓞ/Ok) it.
 - 4 If you want to exit the OSD menu, move the joystick to ◀ until you exit.
- When you enter the menu, instructions on how to use the button will appear in the bottom right corner of the screen.



Quick Settings



PBP



Picture



General



Reset

Each option is described below.

Menu		Description
Quick Settings	Brightness	Adjusts the color contrast and brightness of the screen.
	Contrast	
	Volume	Adjusts the volume level.
		 NOTE • You can adjust Mute/ Unmute by moving the joystick button to ▼ in the Volume menu.
	Input	Selects the input mode.
	Ratio	Adjusts the aspect ratio of the screen.
PBP	PBP	Displays the screens of two input modes on one monitor.
Picture	Picture Mode	Changes the picture mode to the one optimized for a given feature.
	Picture Adjust	Adjusts the Brightness Stabilization, SUPER RESOLUTION+, Sharpness, Black Level, HDMI ULTRA HD Deep Color, DFC, Response Time, Black Stabilizer, and Uniformity.
	Color Adjust	Adjusts the Gamma, Color Temp, and Six Color.
General		Sets Language, SMART ENERGY SAVING, Power LED, Automatic Standby, DisplayPort 1.2, Quick Charge, Buzzer, and OSD Lock.
Reset		Restores the default settings.
◀	Exit	Exits the OSD menu.



CAUTION

- Your monitor's OSD (On Screen Display) may differ slightly from that shown in this manual.

Quick Settings

- 1 To view the OSD menu, press the joystick button at the bottom of the monitor and then enter the **Menu**.
- 2 Go to **Quick Settings** by moving the joystick.
- 3 Configure the options following the instructions that appear in the bottom right corner.
- 4 To return to the upper menu or set other menu items, move the joystick to ◀ or pressing (⊙/Ok) it.
- 5 If you want to exit the OSD menu, move the joystick to ◀ until you exit .

Each option is described below.

Menu > Quick Settings	Description
Brightness	Adjusts the brightness of the screen.  NOTE <ul style="list-style-type: none"> • You can adjust the Brightness Stabilization to On/ Off by pressing the ▼ button in the Brightness menu. • When the Brightness Stabilization is On, Brightness menus becomes disabled. • When the Brightness Stabilization is On, SMART ENERGY SAVING and DFC menus become disabled. • When Picture Mode is set as DICOM, or Gamma is set as DICOM Gamma Curve, the Brightness adjustment function is deactivated.
Contrast	Adjusts the color contrast of the screen.

Menu > Quick Settings	Description	
Volume	Adjusts the volume level.  NOTE <ul style="list-style-type: none"> You can adjust Mute/ Unmute by moving the joystick button to ▼ in the Volume menu. 	
Input	Selects the input mode.	
Ratio	Adjusts the aspect ratio of the screen.	
	Wide	Displays the video in widescreen, regardless of the video signal input.
	Original	Displays video according to the aspect ratio of the video signal input.
	1:1	The aspect ratio is not adjusted from the original.

 **NOTE**

- The display may look the same for **Wide**, **Original**, and **1:1** options at the recommended resolution (3840 x 2160).
- The ratio is disabled in the interlaced signal.

PBP

- 1 To view the OSD menu, press the joystick button at the bottom of the monitor and then enter the **Menu**.
- 2 Go to **PBP** by moving the joystick.
- 3 Configure the options following the instructions that appear in the bottom right corner.
- 4 To return to the upper menu or set other menu items, move the joystick to ◀ or pressing (●/Ok) it.
- 5 If you want to exit the OSD menu, move the joystick to ◀ until you exit .

Each option is described below.

Menu > PBP	Description				
Sub	Displays the screens of two input modes on one monitor.				
	PBP Connection		Sub Screen (Right)		
			HDMI 1	HDMI 2	DisplayPort
	Main Screen (Left)	HDMI 1	X	X	O
HDMI 2		X	X	O	
DisplayPort		O	O	X	
Sound Out	Changes the audio output in PBP mode.				
	Main	Selects the input for Main .			
	Sub	Selects the input for Sub .			
Swap	Toggles between the main screen and sub screen in PBP mode.				
Sub Full	Converts the sub screen in PBP mode to wide screen.				

Menu > PBP	Description	
Ratio	Adjusts the aspect ratio of the main screen or sub screen.	
	Main	Wide Displays the video to fit the PBP screen, regardless of the video signal input.
		Original Displays the video in the aspect ratio of the video signal input on the PBP screen.
	Sub	Wide Displays the video to fit the PBP screen, regardless of the video signal input.
Original Displays the video in the aspect ratio of the video signal input on the PBP screen.		

 **NOTE**

- When the **Sub** mode is **Off**, **Sound Out**, **Swap**, **Sub Full**, and **Ratio** menus become disabled. The **Main / Sub** options for **Ratio** become disabled if there is no signal.
- The optimal resolution for **PBP** mode is set automatically when **PBP** mode is set.

Picture

- 1 To view the OSD menu, press the joystick button at the bottom of the monitor and then enter the **Menu**.
- 2 Go to **Picture** by moving the joystick.
- 3 Configure the options following the instructions that appear in the bottom right corner.
- 4 To return to the upper menu or set other menu items, move the joystick to ◀ or pressing (●/Ok) it.
- 5 If you want to exit the OSD menu, move the joystick to ◀ until you exit .

Each option is described below.

Menu > Picture	Description	
Picture Mode	Custom	Allows the user to adjust each element. The color mode of the main menu can be adjusted.
	Mono	Mono (black and white) color mode.
	Reader	Optimizes the screen for viewing documents. You can brighten the screen in the OSD menu.
	sRGB	A standard RGB color space for the monitor and printer.
	Color Weakness	This mode is for users who cannot distinguish between red and green. It enables users with color weakness to easily distinguish between the two colors.

Menu > Picture	Description		
Picture Mode	EBU	A standard TV PAL color space for broadcasting.	
	REC709	A standard HDTV color space for broadcasting.	
	SMPTE-C	A standard TV NTSC color space for broadcasting.	
	DICOM	A mode optimized for viewing medical images.	
	Calibration 1	Adjusts to the last calibrated screen.	
	Calibration 2	Adjusts to the previously calibrated screen.	
<div style="display: flex; align-items: center;">  <div> <p>NOTE</p> <ul style="list-style-type: none"> • If the Picture Mode is changed in the DP (DisplayPort) input, the screen may flicker or the resolution of your PC screen may be affected. • Calibration 2: Installation of TRUE COLOR PRO and proceeding Calibration will enable this menu. </div> </div>			
Picture Adjust	Brightness Stabilization	Maintains the brightness configured of the screen.	
		On	Adjusts the brightness automatically.
	Off	Deactivates the function, and allows the user to configure the brightness.	
	SUPER RESOLUTION+	High	Optimized picture quality is displayed when a user wants crystal clear images. It is effective for high quality video or game.
		Middle	The optimized picture quality is displayed when a user wants images between low and high modes for comfortable viewing. It is effective for UCC or SD video.
		Low	The optimized picture quality is displayed when a user wants smooth and natural images. It is effective for slow-moving pictures or still images.
		Off	Select this option for everyday viewing. SUPER RESOLUTION+ is turned off in this mode.

Menu > Picture	Description				
Picture Adjust	Sharpness	Adjusts the sharpness of the screen.			
	Black Level	Sets the offset level (for HDMI only). • Offset: as a reference for a video signal, this is the darkest color the monitor can display.			
		High	Keeps the current contrast ratio of the screen.		
		Low	Lowers the black levels and raises the white levels from the current contrast ratio of the screen.		
	HDMI ULTRA HD Deep Color	Provides sharper images when connected to a device supporting ULTRA HD Deep Color.			
		4K@ 60 Hz Support Format¹⁾			
		Resolution	Frame rate(Hz)	Color Depth / Chroma Sampling	
				8 bit	10 bit
		3840 x 2160	59.94 60.00	YCbCr 4:2:0	
				YCbCr 4:2:2	
YCbCr 4:4:4				-	
RGB 4:4:4	-				
1) Supported when HDMI ULTRA HD Deep Color is set to On .					
 NOTE <ul style="list-style-type: none"> • If the connected device does not support ULTRA HD Deep Color, the feature may not work properly. • If a problem occurs, set the HDMI ULTRA HD Deep Color option to Off. 					
DFC	On	Adjusts the brightness automatically according to the screen.			
	Off	Disables the DFC .			

Menu > Picture	Description		
Picture Adjust	Response Time	<p>Sets a response time for displayed pictures based on the speed of the screen.</p> <p>For a normal environment, it is recommended that you use Middle. For a fast-moving picture, it is recommended that you use High.</p> <p>Setting to High may cause image sticking.</p>	
		High	Sets the response time to High.
		Middle	Sets the response time to Middle.
		Low	Sets the response time to Low.
		Off	Does not use the response time improvement feature.
	Black Stabilizer	<p>You can control the black contrast to have better visibility in dark scenes.</p> <p>Increasing the Black Stabilizer value brightens the low gray level area on the screen. (You can easily distinguish objects on dark game screens.)</p> <p>Reducing the Black Stabilizer value darkens the low gray level area and increases the dynamic contrast on the screen.</p>	
	Uniformity	Adjusts the uniformity of screen brightness.	
		On	Enables the Uniformity feature.
		Off	Disables the Uniformity feature.



Menu > Picture	Description		
Color Adjust	Gamma	Custom gamma settings: Gamma 1.8, Gamma 2.0, Gamma 2.2, Gamma 2.4, Gamma 2.6, DICOM Gamma Curve, Off. The higher the gamma value, the darker the image becomes. Likewise, the lower the gamma value, the lighter the image becomes.	
	Color Temp	Manual	Adjusts the color temperature in 500K increments. (Note that 9300K is supported rather than 9500K.)
		Custom	The user can customize the red, green and blue color.
		6500K	Sets the picture color to the color temperature of a reddish 6500K.
		8500K	Sets the picture color to the color temperatures of 8500K, setting to a color between red and blue.
		9300K	Sets the picture color to the color temperature of a bluish 9300K.
Color Adjust	Red	You can customize the picture color using red, green and blue.	
	Green		
	Blue		
	Six Color	Fulfills your color requirements by adjusting the hue and saturation of the six colors (red, green, blue, cyan, magenta and yellow). The settings are then saved.	
		Hue	Adjusts the tone of the screen colors.
	Saturation	Adjusts the saturation of the screen colors. The lower the value, the less saturated and brighter the colors become. The higher the value, the more saturated and darker the colors become.	
	Reset	Returns the colors to the default settings.	

General

- 1 To view the OSD menu, press the joystick button at the bottom of the monitor and then enter the **Menu**.
- 2 Go to **General** by moving the joystick.
- 3 Configure the options following the instructions that appear in the bottom right corner.
- 4 To return to the upper menu or set other menu items, move the joystick to ◀ or pressing (⊙/Ok) it.
- 5 If you want to exit the OSD menu, move the joystick to ◀ until you exit .

Each option is described below.

Menu > General	Description	
Language	Sets the menu screen to the desired language.	
SMART ENERGY SAVING	Conserve energy by using luminance compensation algorithm.	
	High	Saves energy using the high-efficiency SMART ENERGY SAVING feature.
	Low	Saves energy using the low-efficiency SMART ENERGY SAVING feature.
	Off	Disables the SMART ENERGY SAVING feature.
Power LED	Turns the power LED on the front of the monitor On or Off .	
	On	The power LED turns on automatically.
	Off	The power LED turns off.
Automatic Standby	Feature that automatically turns off the monitor when there is no movement on the screen for a period of time. You can set a timer for the auto-off function. (Off , 4 H , 6 H , and 8 H)	

Menu > General	Description					
DisplayPort 1.2	Enables or disables DisplayPort 1.2.  NOTE <ul style="list-style-type: none"> • Be sure to configure this option according to the DisplayPort version supported by your graphics card. Set this option to Disable if your graphics card does not support DisplayPort 1.2. • When DisplayPort 1.2 is disabled, you cannot use the 10-bit output of your video card. 					
Quick Charge	Quick Charge is a feature that rapidly charges the device connected to the USB 3.0 port. <table border="1" data-bbox="295 448 409 533"> <tr> <td data-bbox="295 448 409 491">On</td> <td data-bbox="409 448 1057 491">Enables Quick Charge.</td> </tr> <tr> <td data-bbox="295 491 409 533">Off</td> <td data-bbox="409 491 1057 533">Disables Quick Charge.</td> </tr> </table>		On	Enables Quick Charge .	Off	Disables Quick Charge .
On	Enables Quick Charge .					
Off	Disables Quick Charge .					
Buzzer	This feature lets you set the sound generated from Buzzer when your monitor powers on to On or Off . <table border="1" data-bbox="295 596 409 675"> <tr> <td data-bbox="295 596 409 639">On</td> <td data-bbox="409 596 1057 639">Enables your monitor's Buzzer.</td> </tr> <tr> <td data-bbox="295 639 409 675">Off</td> <td data-bbox="409 639 1057 675">Disables your monitor's Buzzer.</td> </tr> </table>		On	Enables your monitor's Buzzer .	Off	Disables your monitor's Buzzer .
On	Enables your monitor's Buzzer .					
Off	Disables your monitor's Buzzer .					
OSD Lock	This feature disables the configuration and adjustment of menus. <table border="1" data-bbox="295 715 409 793"> <tr> <td data-bbox="295 715 409 758">On</td> <td data-bbox="409 715 1057 758">Enables OSD Lock.</td> </tr> <tr> <td data-bbox="295 758 409 793">Off</td> <td data-bbox="409 758 1057 793">Disables OSD Lock.</td> </tr> </table>  NOTE <ul style="list-style-type: none"> • All features are disabled except Brightness, Contrast, Volume, Input in Quick Settings, and OSD Lock, Information in General. 		On	Enables OSD Lock .	Off	Disables OSD Lock .
On	Enables OSD Lock .					
Off	Disables OSD Lock .					
Information	Displays the Total Power On Time, Serial Number and Resolution information.					

Reset

- 1 To view the OSD menu, press the joystick button at the bottom of the monitor and then enter the **Menu**.
- 2 Go to **Reset** by moving the joystick.
- 3 Configure the options following the instructions that appear in the bottom right corner.
- 4 To return to the upper menu or set other menu items, move the joystick to ◀ or pressing (●/Ok) it.
- 5 If you want to exit the OSD menu, move the joystick to ◀ until you exit .

Each option is described below.

Menu > Reset	Description
Do you want to reset your settings?	
Reset	Restores the default settings.
Cancel	Cancel the reset.

TROUBLESHOOTING

Nothing is displayed on the screen.	
Is the monitor's power cord plugged in?	<ul style="list-style-type: none"> • Check if the power cord is correctly plugged into the power outlet.
Is the power LED on?	<ul style="list-style-type: none"> • Check the power cable connection and press the power button.
Is the power on and the power LED displaying white?	<ul style="list-style-type: none"> • Check that the connected input is enabled (Menu > Quick Settings > Input).
Is the power LED blinking?	<ul style="list-style-type: none"> • If the monitor is in sleep mode, move the mouse, or press any key on the keyboard, to switch the display on. • Check if the computer is turned on.
Is the OUT OF RANGE message being displayed?	<ul style="list-style-type: none"> • This occurs when signals transferred from the PC (graphics card) are out of the horizontal or vertical frequency range of the monitor. Please see the Product Specification section of this manual to set the appropriate frequency.
Is the No Signal message being displayed?	<ul style="list-style-type: none"> • This is displayed when the signal cable between the PC and the monitor is missing or disconnected. Check the cable and reconnect it.

The OSD Lock message is being displayed.	
Are some functions not available when you press the Menu button?	<ul style="list-style-type: none"> • The OSD is locked. Go to Menu > General and set OSD Lock to Off.

The screen retains an image.	
Does image sticking occur even when the monitor is turned off?	<ul style="list-style-type: none"> • Displaying a still image for a prolonged time may cause damage to the screen, resulting in the retention of the image. • To extend the lifetime of the monitor, use a screensaver.

Screen display is unstable and shaky. / Images displayed on the monitor leave shadow trails.	
Did you select the appropriate resolution?	<ul style="list-style-type: none"> • If the selected resolution is HDMI 1080i 60/50 Hz (interlaced), the screen may be flickering. Change the resolution to 1080p or the recommended resolution.

NOTE

- Vertical Frequency: In order to display an image, the screen must be refreshed dozens of times per second, like a fluorescent lamp. The number of times the screen is refreshed per second is called vertical frequency, or refresh rate, and is represented by Hz.
- Horizontal Frequency: The time it takes to display one horizontal line is called the horizontal cycle. If 1 is divided by the horizontal interval, the result is the number of horizontal lines displayed per second. This is called horizontal frequency and is represented by kHz.
- Check if the graphics card's resolution or frequency is within the range allowed by the monitor and set it to the recommended (optimal) resolution **Control Panel > Display > Settings** in Windows. (The settings may differ depending on the operating system (OS) you use.)
- Not setting the graphics card to the recommended (optimal) resolution may result in blurred text, a dimmed screen, a truncated display area or misalignment of the display.
- The setting methods may be different depending on the computer or operating system, and some resolutions may not be available depending on the performance of the graphics card. If this is the case, contact the manufacturer of the computer or graphics card for assistance.
- Some graphics cards may not support 3840 x 2160 resolution. If the resolution cannot be displayed, contact the manufacturer of your graphics card.

The display color is abnormal.	
Does the display appear discolored (16 colors)?	<ul style="list-style-type: none"> • Set the color to 24 bit (true color) or higher. In Windows, go to Control Panel > Display > Settings > Color Quality. (The settings may differ depending on the operating system (OS) you use.)
Does the display color appear unstable or monochrome?	<ul style="list-style-type: none"> • Check if the signal cable is connected properly. Reconnect the cable or reinsert the PC's graphics card.
Are there spots on the screen?	<ul style="list-style-type: none"> • When using the monitor, pixilated spots (red, green, blue, white, or black) may appear on the screen. This is normal for an LCD screen. It is not an error, nor is it related to the monitor's performance.

Do you see an "Unrecognized monitor, Plug and Play (VESA DDC) monitor found" message?	
Have you installed the display driver?	<ul style="list-style-type: none"> • Be sure to install the display driver from the display driver CD (or diskette) that comes with your display. Or, you can also download the driver from our web site: http://www.lg.com. • Make sure to check if the graphics card supports Plug and Play function.

No sound from the headphone port or speaker.	
Are images displayed using DisplayPort or HDMI input without sound?	<ul style="list-style-type: none"> • Try increasing the volume using the button on the monitor. • Set the audio output of the PC to the monitor you are using. On Microsoft Windows, go to Control Panel > Hardware and Sound > Sound > set the monitor as default device. (The settings may differ depending on the operating system (OS) you use.)

PRODUCT SPECIFICATIONS

The product specifications are subject to change without prior notice for product improvements.

" ~ " refers to alternating current (AC), " --- " refers to direct current (DC).

LCD Screen	Type	TFT (Thin Film Transistor) LCD (Liquid Crystal Display) Screen	
	Pixel Pitch	0.1554 mm x 0.1554 mm	
Resolution	Maximum resolution	3840 x 2160 @ 60 Hz	
	Recommended resolution		
Video signal	Horizontal frequency	30 kHz to 135 kHz	
	Vertical frequency	56 Hz to 61 Hz	
Input Connectors	HDMI IN1, HDMI IN2, DP (DisplayPort) IN, H/P, USB (SS) 1, 2, USB UP (SS)		
Power Source	Power Rating	19 V --- 3.42 A	
	Power consumption	Max 65 W Sleep Mode: ≤ 0.5 W Off Mode: ≤ 0.3 W	
AC/DC Adaptor	DA-65J19 type, manufactured by Asian Power Devices Inc. (APD) Input: 100-240 V~ 50-60 Hz, 1.5-0.7 A Output: 19 V --- 3.42 A Class I		
Environmental Conditions	Operating Conditions	Temperature	0 °C to 40 °C
		Humidity	0 % to 80 %
		Pressure	700 hPa to 1060 hPa
	Storing Conditions	Temperature	-20 °C to 60 °C
		Humidity	0 % to 85 %
		Pressure	500 hPa to 1060 hPa

Dimensions (mm)	Monitor Size (Width x Height x Depth)	
	With Stand	615.0 x 425.2 x 222.6
	Without Stand	615.0 x 365.1 x 42.7
Weight (without packaging) (kg)	With Stand	6.2
	Without Stand	4.7

Factory Support Mode

DisplayPort

Preset Mode	Horizontal Frequency (kHz)	Vertical Frequency (Hz)	Polarity (H/V)	Remarks
640 x 480	31.469	59.94	-/-	
800 x 600	37.879	60.317	+/+	
1024 x 768	48.363	60	-/-	
1152 x 864	54.347	60.05	+/+	
1280 x 720	45	60	+/+	
1280 x 1024	63.981	60.02	+/+	
1600 x 900	60	60	+/+	
1920 x 1080	67.5	60	+/-	
1920 x 2160	133.32	60	+/-	Recommended resolution for PBP
2560 x 1440	88.79	59.95	+/-	
3840 x 2160	66.66	30	+/-	
3840 x 2160	133.32	60	+/-	

HDMI

Preset Mode	Horizontal Frequency (kHz)	Vertical Frequency (Hz)	Polarity (H/V)	Remarks
640 x 480	31.469	59.94	-/-	
800 x 600	37.879	60.317	+/+	
1024 x 768	48.363	60	-/-	
1152 x 864	54.347	60.05	+/+	
1280 x 720	45	60	+/+	
1280 x 1024	63.981	60.02	+/+	
1600 x 900	60	60	+/+	
1920 x 1080	67.5	60	+/-	
1920 x 2160	133.29	60	+/-	Recommended resolution for PBP
2560 x 1440	88.79	59.95	+/-	
3840 x 2160	67.5	30	+/-	
3840 x 2160	135	60	+/-	When the HDMI ULTRA HD Deep Color is set to On

HDMI Timing (Video)

Preset mode	Horizontal Frequency (kHz)	Vertical Frequency (Hz)	Remarks
480p	31.5	60	
720p	45.0	60	
1080p	67.5	60	
2160p	135	60	When the HDMI ULTRA HD Deep Color is set to On

Power LED

Mode	LED Color
On Mode	White
Sleep Mode	Flashing White
Off Mode	Off



To obtain the source code under GPL, LGPL, MPL, and other open source licenses, that is contained in this product, please visit <http://opensource.lge.com>.

In addition to the source code, all referred license terms, warranty disclaimers and copyright notices are available for download.

LG Electronics will also provide open source code to you on CD-ROM for a charge covering the cost of performing such distribution (such as the cost of media, shipping, and handling) upon email request to opensource@lge.com. This offer is valid for three (3) years from the date on which you purchased the product.

Read the Owner's Manual (CD) carefully and keep it at hand. Please note that the label attached to the product provides information for product support.

Model _____
Serial No. _____

WARNING: This equipment is compliant with Class A of CISPR 32. In a residential environment this equipment may cause radio interference.