



Scan the QR code to see the manual.



OWNER'S MANUAL

AIR PURIFIER



Before beginning installation, read these instructions carefully. This will simplify installation and ensure that the product is installed correctly and safely. Leave these instructions near the product after installation for future reference.

ENGLISH

AS25GCBZ0

TABLE OF CONTENTS

This manual may contain images or content that may be different from the model you purchased.

This manual is subject to revision by the manufacturer.

SAFETY INSTRUCTIONS

READ AND SAVE THESE INSTRUCTIONS	3
WARNING INSTRUCTIONS	3
CAUTION INSTRUCTIONS	7

OPERATION

Product Overviews	9
Preparation before Operation.....	13
Examining Features	19
Operating the Air Purifier	21
Using the Extra Functions	21
Overall Air Quality	24

SMART FUNCTIONS

LG ThinQ Application	25
Smart Diagnosis	26

MAINTENANCE

Maintaining the Product	28
-------------------------------	----

TROUBLESHOOTING

Before Calling for Service.....	33
---------------------------------	----

APPENDIX

Information.....	36
------------------	----

SAFETY INSTRUCTIONS

READ AND SAVE THESE INSTRUCTIONS

The following safety guidelines are intended to prevent unforeseen risks or damage from unsafe or incorrect operation of the appliance. The guidelines are separated into 'WARNING' and 'CAUTION' as described below.

Safety Messages



This symbol is displayed to indicate matters and operations that can cause risk. Read the part with this symbol carefully and follow the instructions in order to avoid risk.



WARNING

This indicates that failure to follow the instructions can cause serious injury or death.



CAUTION

This indicates that failure to follow the instructions can cause minor injury or damage to the product.

WARNING INSTRUCTIONS

WARNING

- To reduce the risk of explosion, fire, death, electric shock, injury or scalding to persons when using this product, follow basic precautions, including the following:

Technical Safety

- This appliance is not intended for use by persons (including children) with reduced physical, sensory or mental capabilities or lack of experience and knowledge, unless they have been given supervision or instruction concerning use of the appliance by a person responsible for their safety.

Children should be supervised to ensure that they do not play with the appliance.

- The fan is not a toy. It should not be played with or placed where young children can reach it.
- If the supply cord is damaged, it must be replaced by the manufacturer, its service agent or similarly qualified person in order to avoid a hazard.
- Only an authorized repair person should disassemble, repair, or modify the appliance.
- Do not touch the power plug with wet hands.
- Do not place the power cord under rugs, carpeting or mats.
- Do not install and use broken parts.
- Do not continue to use the product if it is visibly damaged.
- Read the maintenance manual carefully before disassembling the machine.

Installation

- Do not install the appliance on an uneven or inclined surface.
- Do not install the appliance in an area exposed to direct sunlight or near heat-generating equipment.
- Do not install the product in a place where combustible gas may leak or industrial oil or metallic particulates are present.
- Do not allow the appliance to push against the power cord or plug.
- Do not bend the power cable excessively or place a heavy object on top of it.
- Do not extend the length of the power cable or alter it.
- Do not use several devices on a multi-socket extension outlet.
- Make the connection securely so that screw in terminals may not be loosened when the cable is pulled.
- Make sure that the power cable cannot be pulled out or damaged during operation.
- When unplugging the power cord, always pull it by the plug.

- Unplug the appliance during thunder or lightning storms or when not in use for a long time.

Operation

- If the appliance is immersed in water, stop using it and contact an LG Electronics Customer Information Center.
- If there is a gas leakage (isobutane, propane, LNG, etc.), do not touch the appliance or power plug and ventilate the area immediately.
- If you detect any abnormal noise, odor or smoke, unplug the appliance immediately and contact an LG Electronics Customer Information Center.
- Do not clean the appliance with brushes, cloths or sponges which are abrasive or made of metal.
- Do not use or store fire, combustibles (ether, benzene, alcohol, drugs, propane, butane, combustible spray, insecticide, air freshener, cosmetics, etc.) or flammable materials (candles, lamps, etc.) near the product.
- Do not allow animals or pets to chew on the power cord.
- Do not move the appliance when it is in operation.
- Do not hit the appliance.
- Do not insert hands or metal objects into the air inlet or outlet.
- Do not put flammables into the appliance.
- Do not move or operate the appliance while its cover is open.
- Do not allow children to climb on or play with the appliance.
- Do not place anything on top of the appliance.
- Be careful not to let body parts get caught in the product when removing product components and/or reassembling them.
- Do not use this heater in small rooms when they are occupied by persons not capable of leaving the room on their own, unless constant supervision is provided.

UVnano Function

NOTE

- The relevant contents apply only to models with the UVnano function.
- This product uses a UVnano LED. Do not disconnect or replace the UVnano LED arbitrarily. LEDs must be replaced only by LG-approved service providers, and the appliance must be disconnected from the power supply before replacing the UV-C emitter.
- Unintended use of the appliance or damage to the housing may result in the escape of dangerous UV-C radiation. UV-C radiation may, even in little doses, cause harm to the eyes and skin.
- This appliance contains a UV-C emitter.
- The UVnano LED is not a part that needs cleaning, so do not clean the UVnano LED or parts with the UV hazard label separately.
- If the UVnano LED is damaged, do not operate it.
- This appliance contains a UV emitter. Do not stare at the light source.
- Do not operate UVnano LED outside of the appliance.
- Appliances that are obviously damaged must not be operated.
- Read the maintenance instructions before opening the appliance.

Maintenance

- Dispose of the packing materials (vinyl, styrofoam, etc.) to keep them out of reach of children.
- Take care not to injure or pinch yourself when you detach and reattach parts of the appliance.
- Turn off and unplug the appliance before cleaning it or replacing the filter.

CAUTION INSTRUCTIONS

CAUTION

- To reduce the risk of minor injury to persons, malfunction, or damage to the product or property when using this product, follow basic precautions, including the following:

Installation

- Do not tilt the appliance to pull or push it when transporting.
- Do not install the appliance in a vehicle, RV, or marine vessel.
- Do not place the appliance near a TV or stereo equipment.
- Do not place the appliance under bright light.
- The appliance must be installed in accordance with national wiring regulations.
- When moving or storing the appliance, wrap the power cord around the base of the appliance to prevent personal injury, damage to the cord or damage to floors.
- Do not place the appliance near curtains.
- When assembling the cat dome or components, do not let other objects come between the parts.

Operation

- Before turning on electrical appliances, must read maintenance instructions.
- Do not use the product for removal of toxic gas such as carbon monoxide.
- Do not use the product for ventilation purposes.
- Do not use the appliance for a long time in a region with unstable voltage.
- Do not place obstacles around the air inlet or outlet.
- For safe use of the appliance, children or others with reduced mental capabilities need to be closely monitored by a person who is responsible for their safety.

- Do not use the product for special purposes such as preserving plants, precision instruments, artworks, etc.
- Do not operate the appliance with wet hands.
- Do not let the moisture from a humidifier directly touch the appliance.
- Do not use the appliance while it is not in an upright position.
- Do not use the appliance near objects vulnerable to heat.
- Do not use detergents, cosmetics, chemicals, air fresheners, or disinfectants in the appliance.
- Do not touch any internal parts while the unit is operating or immediately after operation.
- Use the filter only for its intended purpose.
- Do not forcefully separate the filters, as the filters are attached.
- Do not insert any objects in the air outlet.
- Do not place a hot object on the product.
- Do not place heavy objects on the product.
- Do not place liquids on the product.

Maintenance

- Do not use strong detergents or solvents to clean the appliance. Use a soft cloth to clean.
- Do not clean the appliance with an alkaline detergent.
- Do not wipe the appliance surface using sulfuric acid, hydrochloric acid or organic solvents (thinner, kerosene etc.) or attach a sticker on the appliance.
- Do not allow water inside the appliance.
- Do not wash the filter with water.
- Be careful not to damage the pre-filter when cleaning it with a vacuum cleaner.

OPERATION

- The exterior or components of the product may vary depending on the model.

Product Overviews

Front

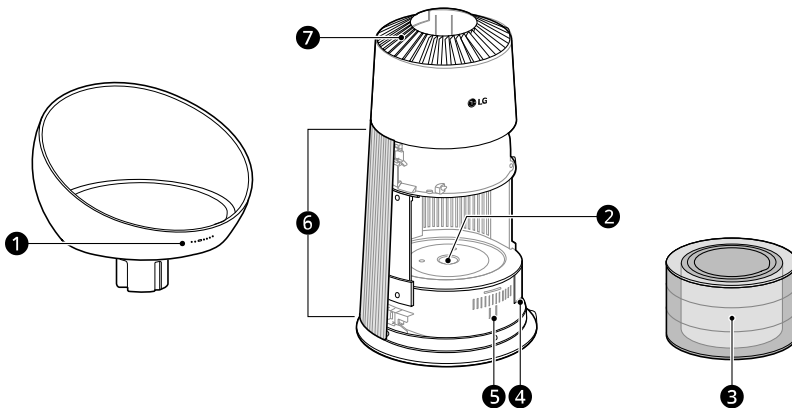

1 Status Panel

- Use it to check the settings of the appliance and the air quality.

2 UVnano LED

- Removes harmful bacteria near the internal fan of the air purifier.

3 Filter

- Minimizes allergens, fine particulates, possible sources of sick house syndrome, smog, and other odors.

4 PM1.0 Sensor

- Detects the dust concentration levels.

5 Smart Diagnosis

- If the product malfunctions, use **Smart Diagnosis** to check the product status.

6 Air Inlet (Cover)

- Air is sucked into the air purifier through the air inlet.
- The front and rear covers can be removed separately.

7 Air Outlet

- Emits purified air from the filter.

Cat Dome

※ It is bottom side of the cat dome.

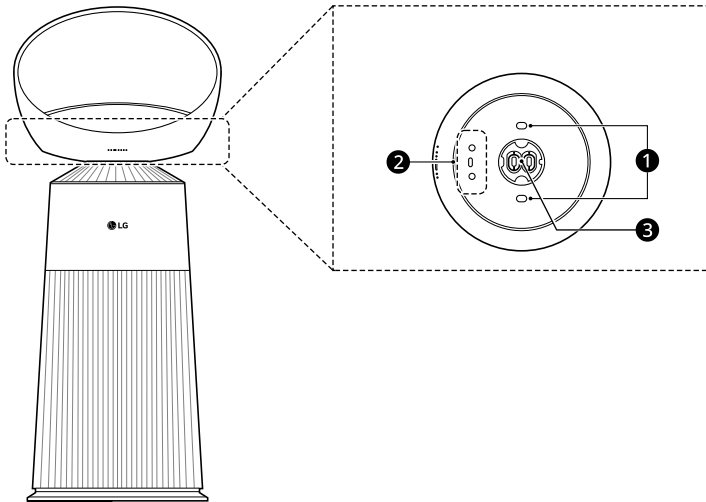

1 Cat Dome Base Separation Button

- The cat dome can be separated by pressing the buttons located on both sides at the same time.

2 Control Panel

- Sets the product functions (Standby On/Off, Speed, Heating, etc.)

3 Cat Dome Joint

- This is the part where the main body and the cat dome are combined.

Filter

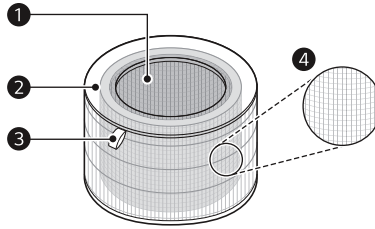

1 Photocatalytic (Deodorization) Filter

- This filter removes even smog-causing substances (SO₂, NO₂), sick house syndrome-causing substances (toluene, formaldehyde), and household odors (ammonia, acetic acid, acetaldehyde).

2 Dust Collection Filter

- Minimizes PM1.0 and cigarette smoke from the air.

3 Filter Handle

- It is used to put in or pull out the filter.
- The side with the handle should face upwards.

4 Pre-filter

- The Pre-filter is coupled to the exterior of the filter and primarily removes household dust with large particles from the air.

⚠ CAUTION

- Do not forcefully separate the filters, as the filters are coupled.
- Do not throw the filters or use them for other purposes.

Components

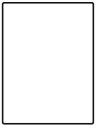

1

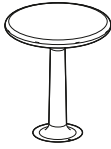

2

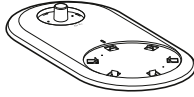

3

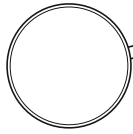

4



5



6

1 Quick Guide

2 Cat Step

3 Cat Step Base

4 Cat Dome Cushion

5 Cat Step Set Fixing Screws (4EA)

6 Product Body Fixing Screws (2EA)

Preparation before Operation

Assembling the Product

Remove the packaging vinyl and the filter vinyl from the product before using the product.

1 Take out the main body, cat dome and accessories from the box and remove the vinyl.

2 Insert the cat step (❶) into the cat step base (❷) so that the mark on the cat step is aligned with the lock open marking on the cat step base.

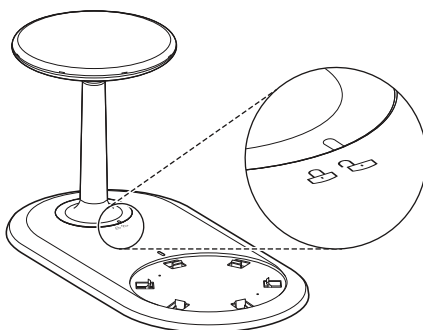
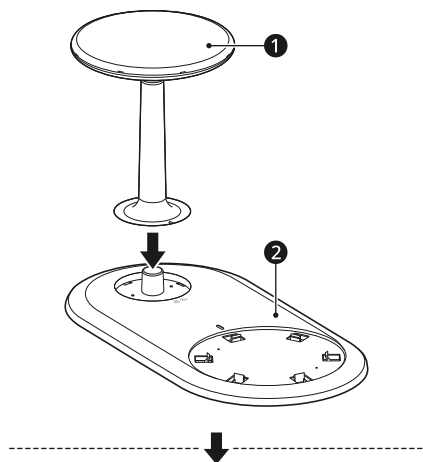

3 Turn the cat step to align the marking on the cat step with the lock closed marking on the cat step base.

- Turn the cat step until a click is heard.

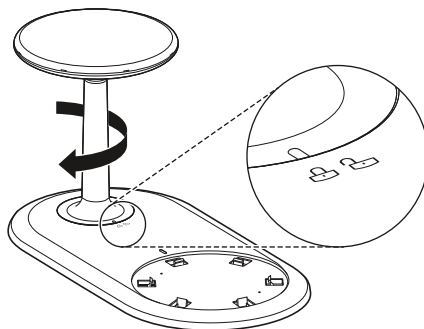

4 Align the marking on the main body of the product with the marking on the cat step base, and then gently press the main body of the product to assemble it to the cat step set.

- When assembling the main body of the product to the cat step base, insert it until a click is heard.

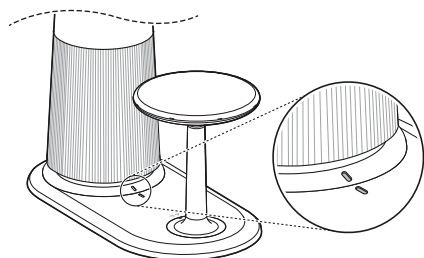

5 Secure the cat step and the main body of the product with the cat step set fixing screw and the main body fixing screw respectively.

- Two long screws are the main body fixing screws.
- Lay the assembled cat step set and the main body of the product on their sides and secure them so that they are stable.
- Check that the cat step set and the main body of the product are securely attached.

14 OPERATION

- Cat step

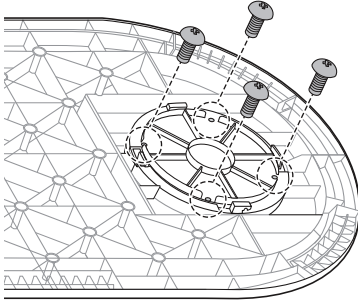

- Product main unit

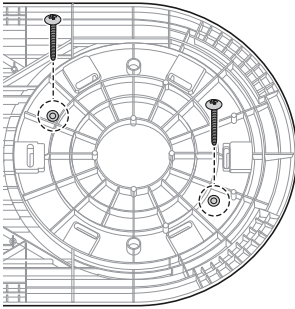

6 Prepare the main body connected to the cat step set and the cat dome, as shown in the figure below.

- The side with the **LG logo** is the front of the product.
- The side with the status panel (1) is the front of the cat dome.

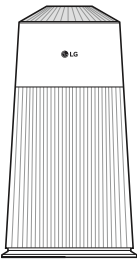

Front

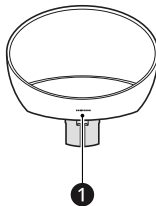

Front of the cat dome

7 Assemble the cat dome to the main body, according to the directions.

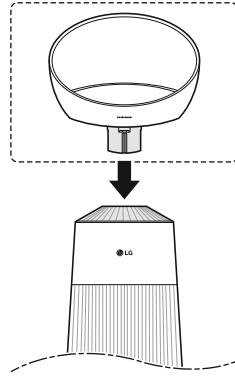

8 Place the cat dome cushion on the cat dome.

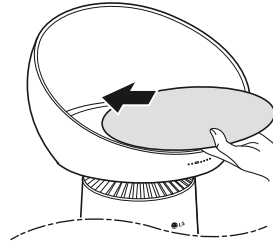

CAUTION

- When assembling the cat dome to the main body, insert it until a click is heard.
 - If it is not assembled correctly, the product won't operate.
- Pay attention to the assembly directions when assembling the cat dome to the main body.
 - Failure to do so may cause malfunction or product failure.
- If power is connected to the main body without assembling the cat dome, the product won't operate.
- For safety, assemble the product in the location where the product is to be installed.

Removing the Protective Vinyl from the Filter

- 1 Take the product out of the box, and remove the vinyl or the fixing tape attached to the product.
- 2 Based on the front of the product, hold and gently pull both sides of the air inlet (cover) to separate it.
 - The side with the **LG logo** at the center of the product is the front of the product.

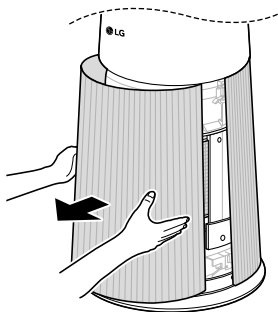

- 3 Remove the filter and detach the vinyl.

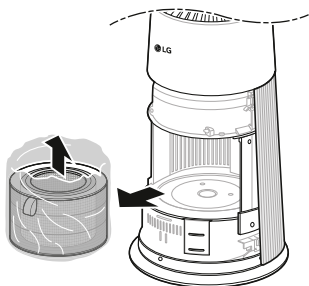

- 4 Install the filter into the product.

- Make sure that the side with the filter handle is facing upward.

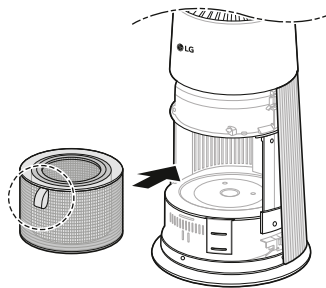

- 5 Insert the fixing part on both sides at the bottom of the cover into the fixing groove in the bottom of the product, and then close the cover.

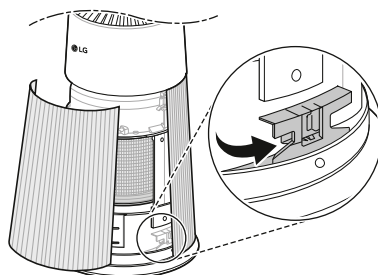

⚠ CAUTION

- Be sure to remove the protective vinyl from the filter before using the product.
- When installing the filter, pay attention to the direction of the filter.
 - Failure to do so may cause malfunction or product failure.
 - The part with the filter handle is the top.

Installation Location Requirements

Install the product at least 1m from walls.

16 OPERATION

- If there is not enough room for air suction, the air purification performance may degrade.

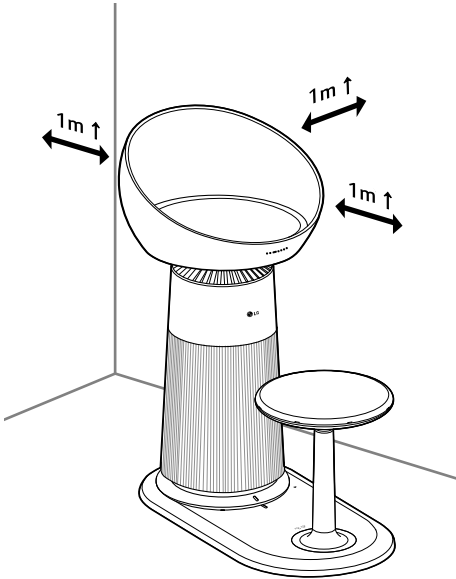

- The performance of the product may differ depending on the operating environment (considering factors such as temperature and humidity).
 - At humidity levels of between 40 % - 70 %, the product's guaranteed performance standards can be achieved.
- Do not install the product in a place exposed to direct sunlight or near lighting fixtures with strong light.
 - This may cause product discoloration.
- Do not install the product near pet food or pads for pets.
 - Doing so may generate odors when using the product.

Changing the Cat Dome

- 1 Separate the cat dome by pulling it up while simultaneously pressing the **Cat Dome Base**

Separation button located on both sides at the bottom of the cat dome.

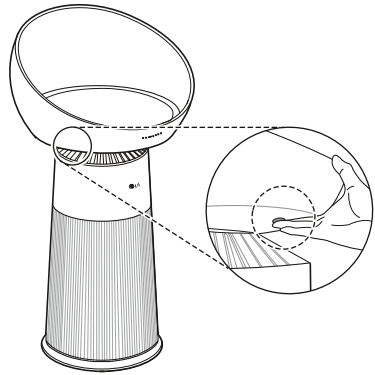

- 2 Assemble any new accessory to the main body.
 - Read "**Assembling the Product**".

CAUTION

- When separating or reassembling the cat dome, be careful not to let water or foreign objects enter the cat dome joint.
- Be careful not to pinch your fingers or nails when separating or reassembling the cat dome.
 - There is a risk of injury.
- When separating the cat dome, be careful not to let the cat dome bump any part of your body (face, chest, etc.).
- Do not separate the cat dome while operating the product.
- Use the **Cat Dome Base Separation** button only for replacing the cat dome.
 - Using the buttons incorrectly may cause injury or product failure.

Transportation Requirements

- When moving or storing the product, make sure that the power cord does not touch the floor by wrapping the power cord around the lower part of the product.
 - Otherwise, it may damage the power plug or scratch the floor.

- When carrying and moving the product
 - Separate the cat step set from the main body of the product. Hold the product from the bottom of the cat dome on both sides to move it safely.

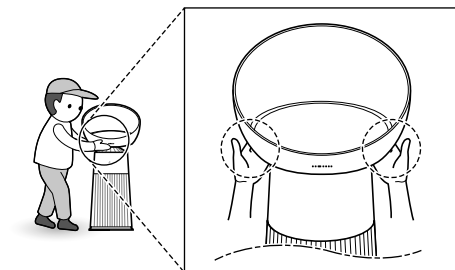

⚠ CAUTION

- Move the product after checking that the cat dome is properly fixed.
- Do not hold the outside cover of the product in order to move the product. The cover may open accidentally, causing the product to drop.
- When grasping the bottom of the cat dome, make sure the **Cat Dome Base Separation** button is not depressed. Doing so may separate the cat dome from the main body and cause it to fall.
 - If the product is dropped, it may cause injury or product failure.
- After lifting and moving the product, reassemble the cat step set and use it.
 - If the main body of the product is used by itself, it may tip over and cause personal injury or product failure.

Encouraging Your Cat to Adapt

If your cat is unfamiliar with the product, use the following method to solve the problem.

Product Installation

- Install the product near the place where your cat usually rests and spends a lot of time.
(For example, if the cat usually sleeps with you in your bed, install the product under the headboard.)
- If your cat likes people, install the product in a place where you spend a lot of time and in a direction that allows your cat to look at you. If the cat is independent or shy, it is recommended to install the product in a place where your cat can spend time quietly alone.
- If the cat tower, bed, cushion, etc., used by the cat are too close, your cat may prefer a familiar resting place and your cat may not use the product frequently. Placing the product in your cat's familiar resting place can make your cat feel comfortable. However, do not place it right next to the cat tower, bed, cushion, etc., and be sure to install it a little distance away from them.
- If the area near the product becomes too hot or cold due to seasonal changes, or if it is easy for it to be influenced by cold winds through doors or windows, move the product to another place.

Function Setting

- Place the product without turning it on and raise the speed gradually from the **Sleep** stage, which operates with less noise.
- Keep the **Continuous Heating** mode on for 7 days so that the cat can become accustomed to the warmth.
 - The time to maintain the warming function can be adjusted through the **LG ThinQ** app.

Use of Cat Supplies or Snacks

- Place light objects with your cat's body odor, such as toys or blankets that your cat usually enjoys playing with, on the cat dome. Or, rub your cat's head with a soft cloth, then rub the cloth against the cat dome to coat it with your cat's body odor.
- You can encourage your cat to use the product by putting a snack on the cat dome and offering your cat a preferred snack when your cat climbs on the cat dome.
- Using catnip scent helps your cat to adapt.

Examining Features

Controlling the Air Purifier

Status Panel

(Front of the cat dome)

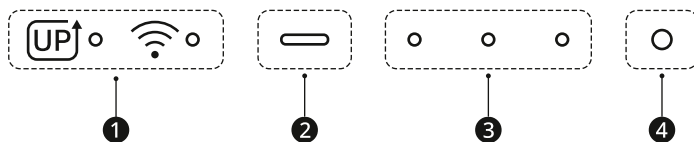

1 Add-on Display

Icon	Description
	It is displayed when Wi-Fi connection is established, enabling remote control.
	It is displayed when a new function that can be upgraded becomes available.

2 Air Quality Light

- You can check the overall air quality through the air quality light.
- In Sleep mode, the air quality light is turned off.

3 Speed Light

- Indicates the speed set among Auto, Low, Middle, High, Turbo and Sleep.

Speed	Display	Description
Auto		3 LEDs circulating
Low		1 LED ON
Middle		2 LEDs ON
High		3 LEDs ON
Turbo		3 LEDs circulating
Sleep		1 LED ON (50% of brightness of Low)

4 Heating Function Indication Lamp

- When the heating function is operating, the LED turns on, according to the heating function status.

20 OPERATION

Heating Function		If there is no cat	If there is a cat
Continuous Heating	Low temperature	Yellow	
	High temperature	Red	
Sensor Heating	Low temperature	White	Yellow
	High temperature		Red

Control Panel

(Bottom side of the cat dome)

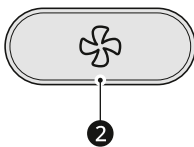
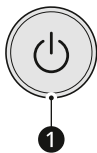

1 Standby On/Off Button

- Turns the product on and off.
- To prepare the product to connect to Wi-Fi through the **LG ThinQ** application, press and hold the button for 3 seconds or more.

2 Speed Button







- Use it to set the fan speed.
- Press and hold down the button for 3 seconds to set or cancel the **Cat Relax** mode.

3 Heating Button

- Use it to set the heating function.
- When you press and hold down the button for 3 seconds, the heating mode will change to **Continuous Heating** mode and **Sensor Heating** mode.

NOTE

- You can use additional functions by pressing the buttons on the control panel for 3 seconds.

Long press (more than 3 seconds)	Extra Functions
 + 	Smart Diagnosis
 + 	Filter Replacement Notification Reset
 +  + 	Reset Zero

Operating the Air Purifier

Things to Know before Operation

- If a weight of 0.4kg or more is detected in the cat dome, the button sound will not be heard even when it is pressed.
- The control panel is located below the cat dome.

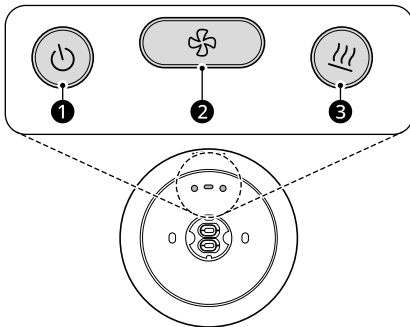

- 1 Standby On/Off Button
- 2 Speed Button
- 3 Heating Button

Standby On/Off

Turns the product on and off.

- Press the **Standby On/Off** button to start operating the product.

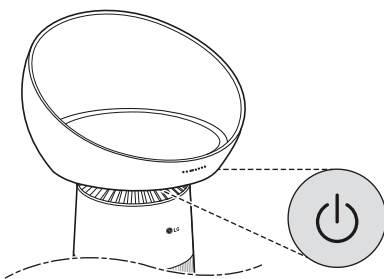

NOTE

- If you stop operation and then resume, it will start cleaning with the mode you last selected.

- If the product is unplugged or a power failure occurs during operation, the most recently used mode (speed) will be memorized.

Adjusting the Fan Speed

You can adjust the fan speed from the air purifier.

- When you press the **Speed** button during product operation, the speed changes in the order of Auto → Low → Middle → High → Turbo → Sleep.

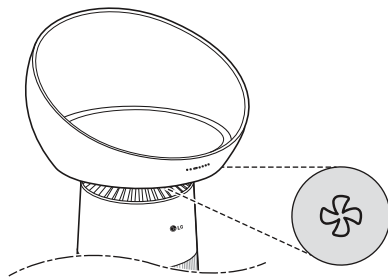

NOTE

- The higher the fan speed, the higher the purification rate in the operating space.
- When Auto is set, the speed will be controlled automatically according to the contamination level of the indoor air.
- When Sleep is set, the air quality light will be turned off.
- When the heating function is set after the sleep timer is set, in **Continuous Heating** mode the heating function indication lamp turns on for 5 seconds and then it turns off, and in **Sensor Heating** mode it blinks twice and then turns off.

Using the Extra Functions

Measuring the Weight of Your Cat

If the cat is in the cat dome while the product is on, it can measure the weight of your cat.

- 1** Before your cat climbs on, press and hold down the **Standby On/Off** button, **Speed** button and **Heating** button at the same time for 3 seconds to set the scale to zero.

- You can check if the scale is set to zero using the **LG ThinQ** app.

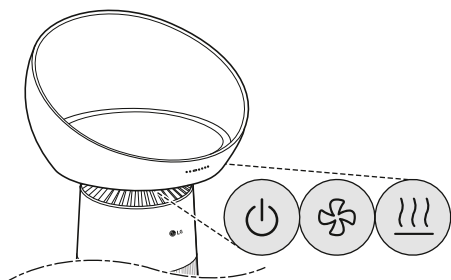

- 2** When your cat climbs onto the cat dome, weight measurement will begin. Check the weight of your cat using the **LG ThinQ** app.

- If a weight of 0.4 kg or more is detected in the cat dome, the product recognizes that the cat is in the cat dome.

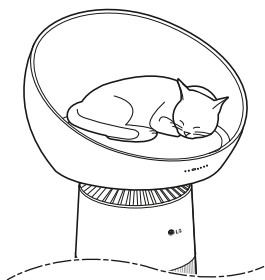

⚠ CAUTION

- If a weight of 15 kg or more is applied to the cat dome, the product and the weight sensor may be damaged.
- If a weight of 15 kg or more is applied to the cat dome, you cannot set the scale to zero.

NOTE

- If other objects are in the cat dome, you may not be able to set the scale to zero accurately.

- In any of the following cases, the weight of your cat may not be measured accurately.
 - If your cat and other objects are in the cat dome.
 - If the cat dome comes into contact with walls or other furniture.
 - If you set the scale to zero while a heavy object is in the cat dome.
 - If your cat moves.

Setting the Heating Function

You can press the **Heating** button to set the heating function.

- When you press the button during product operation, the mode changes in the order of **Low temperature (Yellow)** → **High temperature (Red)** → **OFF**.
- When you press and hold the button for 3 seconds, the heating mode will change to **Continuous Heating** mode and **Sensor Heating** mode.
 - In the **Continuous Heating** mode, the heating function operates even if the cat is not sitting on the cat dome.
 - In the **Sensor Heating** mode, the heating function operates when a weight of 0.4kg or more is detected in the cat dome.
 - When you change the temperature in **Sensor Heating** mode by pressing the **Heating** button, the heating function indication lamp blinks twice.
 - If a weight of 0.4kg or more is not detected in the **Sensor Heating** mode, the heating function indication lamp turns on white.

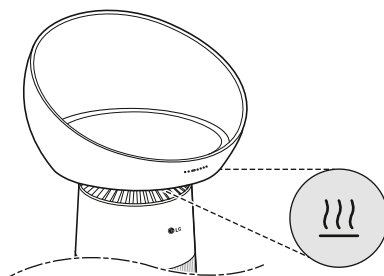

⚠ CAUTION

- Placing a latex object on top of the heating sheet can cause a fire.
- If you set the heating function to **High temperature** and use it for a long time, your pet may suffer from low-temperature burns.
- If your pet sleeps or stays in the same posture for more than 1 hour with a mat temperature above 40°C, your pet may suffer from low temperature burns.

NOTE

- You can check the heating mode status using the **LG ThinQ** app.
- Initially, the heating function is set to **OFF**.
- The heating function can be used during the air purification function operation.
 - The heating function cannot be used alone.
- The heating function operates continuously for up to 8 hours. After 8 hours, the function turns off automatically. The heating function operation time can be changed using the **LG ThinQ** app.
- The low temperature is 34 °C and the high temperature is 39 °C.
 - The temperature may change depending on the surrounding environment.

Setting the Cat Relax Mode

Adjust the speed to low to allow your cat to rest comfortably after climbing on the cat dome.

- When you press and hold down the **Speed** button for 3 seconds during product operation, the **Cat Relax** mode will be set.

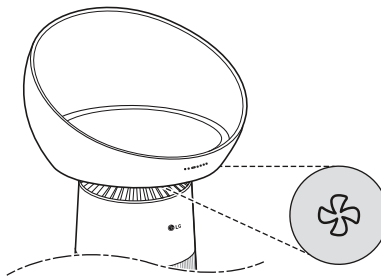

NOTE

- When the **Cat Relax** mode is set, you can adjust the speed when your cat is not on the cat dome.
 - If a weight of 0.4 kg or more is detected on the cat dome, you cannot adjust the speed.
 - Set the scale to zero by referring to **Measuring the Weight of Your Cat**.
- When you press and hold down the **Speed** button for 3 seconds during operation in **Cat Relax** mode, the **Cat Relax** mode will be canceled.
- If the **Cat Relax** mode is set, the speed is automatically adjusted when your cat climbs onto the cat dome. When your cat comes down from the cat dome, the speed returns to its previously set speed.

Using UVnano

The function sterilizes the fan inside the air purifier to circulate cleaner air.

- Change the UVnano setting with the **LG ThinQ** application.

NOTE

- UVnano is a compound word of "UV" LEDs that reduce harmful bacteria and "nanometers", as in the ultraviolet wavelength unit.
- The UVnano function is enabled by default when using the product for the first time.

Overall Air Quality

Understanding Overall Air Quality

The overall air quality is calculated based on the concentration of particulates and is categorized in 4 levels based on the level of pollution in the air. (Green, Yellow, Orange, and Red)

Color	Overall air quality	Concentration of PM ($\mu\text{g}/\text{m}^3$)		
	State	PM10	PM2.5	PM1.0
Red	Poor	255 or more	56 or more	56 or more
Orange	Unhealthy	155 ~ 254	36 ~ 55	36 ~ 55
Yellow	Moderate	55 ~ 154	13 ~ 35	13 ~ 35
Green	Good	54 or less	12 or less	12 or less

NOTE

- Overall air quality is determined based on the concentration of particulate matter (PM).
- The PM concentration measurement was tested using LG Electronics' standard test materials.
- Differences in PM concentration values may be the result of different methods of measuring or differences in the actual PM concentration levels.
 - If the PM concentration is high, there may be a larger difference between the displayed concentration and the actual concentration.

SMART FUNCTIONS

LG ThinQ Application

The **LG ThinQ** application allows you to communicate with the appliance using a smartphone.

LG ThinQ Application Features

Smart Diagnosis

If you experience a problem while using the appliance, this **Smart Diagnosis** feature will help you diagnose the problem.

Settings

Allows you to set various options on the appliance and in the application.

NOTE

- In the following cases, you must update the network information for each appliance in the **LG ThinQ** application under **Device Cards** → **Settings** → **Change Network**.
 - wireless router is changed
 - wireless router password is changed
 - Internet service provider is changed
- The application is subject to change for appliance improvement purposes without notice to users.
- Functions may vary by model.

Before Using LG ThinQ Application

This feature is only available on models with Wi-Fi function.

- 1 Check the distance between the appliance and the wireless router (Wi-Fi network).
 - If the distance between the appliance and the wireless router is too far, the signal strength becomes weak. It may take a long time to connect or installation may fail.

- 2 Turn off the Mobile data or Cellular Data on your smartphone.

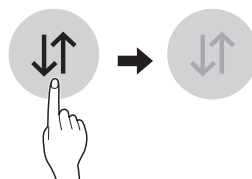

- 3 Connect your smartphone to the wireless router.

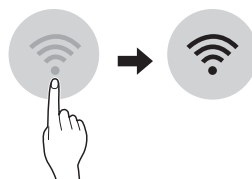

NOTE

- To verify the Wi-Fi connection, check that the Wi-Fi  icon on the status panel is lit.
- **The appliance supports 2.4 GHz Wi-Fi networks only.** To check your network frequency, contact your Internet service provider or refer to your wireless router manual.
- **LG ThinQ** is not responsible for any network connection problems or any faults, malfunctions, or errors caused by network connection.
- If the appliance is having trouble connecting to the Wi-Fi network, it may be too far from the router. Purchase a Wi-Fi repeater (range extender) to improve the Wi-Fi signal strength.
- The Wi-Fi connection may not connect or may be interrupted because of the home network environment.
- The network connection may not work properly depending on the Internet service provider.
- The surrounding wireless environment can make the wireless network service run slowly.

NOTE

- If the appliance cannot be connected due to problems with the wireless signal transmission, unplug the appliance and wait about a minute before trying it again.
 - If the firewall on your wireless router is enabled, disable the firewall or add an exception to it.
 - The wireless network name (SSID) should be a combination of English letters and numbers. (Do not use special characters.)
 - Smartphone user interface (UI) may vary depending on the mobile operating system (OS) and the manufacturer.
 - If the security protocol of the router is set to WEP, the network setup may fail. Change the security protocol (WPA2 is recommended) and connect the product again.
-

Installing the LG ThinQ Application

Search for the **LG ThinQ** application from the Google Play Store or Apple App Store on a smartphone. Follow instructions to download and install the application.

Open Source Software Notice Information

To obtain the source code that is contained in this product, under GPL, LGPL, MPL, and other open source licenses that have the obligation to disclose source code, and to access all referred license terms, copyright notices and other relevant documents, please visit <https://opensource.lge.com>.

LG Electronics will also provide open source code to you on CD-ROM for a charge covering the cost of performing such distribution (such as the cost of media, shipping, and handling) upon email request to opensource@lge.com.

This offer is valid to anyone in receipt of this information for a period of three years after our last shipment of this product.

Smart Diagnosis

Use this feature to help you diagnose and solve problems with your appliance.

NOTE

- For reasons not attributable to LGE's negligence, the service may not operate due to external factors such as, but not limited to, Wi-Fi unavailability, Wi-Fi disconnection, local app store policy, or app unavailability.
 - The feature may be subject to change without prior notice and may have a different form depending on where you are located.
-

Using LG ThinQ to Diagnose Issues

If you experience a problem with your Wi-Fi equipped appliance, it can transmit troubleshooting data to a smartphone using the **LG ThinQ** application.

- Launch the **LG ThinQ** application and select the **Smart Diagnosis** feature in the menu. Follow the instructions provided in the **LG ThinQ** application.

Using Audible Diagnosis to Diagnose Issues

Follow the instructions below to use the audible diagnosis method.

- Launch the **LG ThinQ** application and select the **Smart Diagnosis** feature in the menu. Follow the instructions for audible diagnosis provided in the **LG ThinQ** application.

- 1 Press and hold the **Speed** and **Heating** buttons for 3 seconds to execute the **Smart Diagnosis** function.

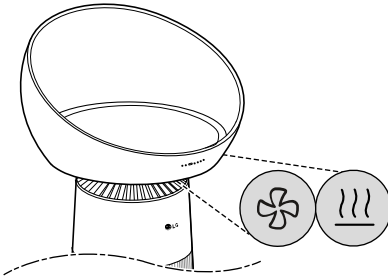

- 2 Place your smartphone near the product.
 - Make sure the microphone of the smartphone faces the front of the product.

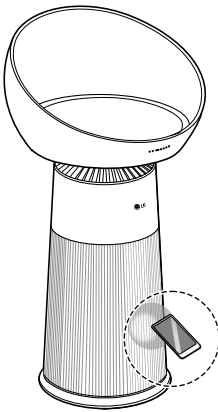

- 3 When data transmission is complete, the **Smart Diagnosis** result will be displayed on the **LG ThinQ** Application.

NOTE

- For accurate diagnosis, do not move the smartphone away from the product until the beeping stops.
- Keep quiet around the product during **Smart Diagnosis**.

MAINTENANCE

Maintaining the Product

Scheduled Maintenance

⚠ WARNING

- Be sure to stop the appliance operation and remove the power plug from the outlet before cleaning and replacing the filter.
- Do not spray water directly on the appliance.

Component	Cleaning frequency	Replacement frequency
 <p>Filter</p>	<p>Pre- filter Clean filter as needed</p>	1 year

NOTE

- The cleaning frequency may vary depending on the operating hours and environment of the appliance.
- If you do not clean the product according to the cleaning frequency, you may experience a bad odor and poor performance.
- The filter must be replaced at the end of its lifespan, and the cost of replacement filters is not covered under the warranty. To purchase new filters, contact an LG Electronics Customer Information Center or visit the website at www.lg.com.
- You can also have the filter cleaned or replaced by the Service Center. You will be charged a nominal fee for filter cleaning and replacement services.
- The upper and lower parts of the filter are made of paper instead of plastic. Repeated removal of the filter may cause scratches on the top and bottom of the filter.

- Even if there are scratches on the top and bottom of the filter, there is no problem in use.

Alerts on the Status Panel

Alert	Description	Measures
	3 LEDs blinking at the same time	Replace the filter.

NOTE

- Filter replacement alerts appear based on the maximum usage time, taking into account the operating hours of the appliance. The replacement frequency is determined by the operating hours and environment.
- If the filter replacement alerts is displayed and you adjust the fan speed, the selected speed will be temporarily displayed, and then the filter replacement alters will reappear.

Cleaning the Exterior

- 1 Remove dust from the air inlet using a vacuum cleaner.

- 2** Remove the cat dome cushion and wipe off the cat dome sides and surfaces with a soft cloth or a wet wipe.

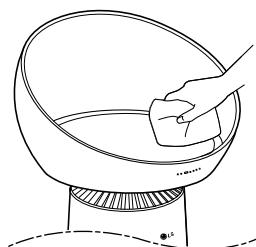
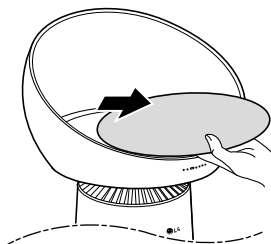

- 3** Separate the cover from the cat dome cushion, remove dust and cat hair from the cover using a tape cleaner and wash the cover.

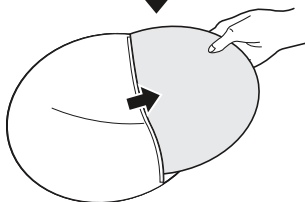
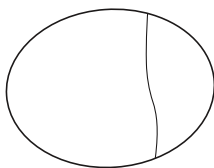

- Never use sulphuric acid, hydrochloric acid or organic solvent (e.g., thinner, kerosene and acetone) to wipe the appliance exterior, or affix labels on the exterior. Doing so may damage the product surface.
- Care should be exercised to prevent flowing of water into the product.
- If the product is stained by soapy water, cosmetics, chemicals, air fresheners, disinfectants, etc., wipe the substance off immediately with a soft cloth or wet wipe.
- Do not let a sharp object such as a key or a knife come into direct contact with the surface of the product.
 - Failure to do so may result in damage to the product's surface.
- Do not let ballpoint pens, crayons, colored pencils, etc., come into direct contact with the surface of the product.
 - Failure to do so may result in staining or damage to the surface of the product.

NOTE

- After washing the cat dome cushion, use it after drying it completely out of direct sunlight.
- Refer to the following when cleaning the cat dome.
 - Wipe it gently with a soft cloth or a wet wipe for dust removal and cleaning.
 - If there is a stain on the side of the cat dome, remove it immediately.
 - If the cat dome sides become contaminated, do not wash the sides with water.
 - Doing so may spread discoloration and contamination.

Cleaning the Particles Sensor

The PM1.0 sensor is the device detecting fine dust and large dust contamination levels, so it is recommended to clean the lens periodically, at least once every 2 months.

⚠ CAUTION

- Do not clean the product with an alkaline detergent.

- 1 Based on the front of the product, hold and gently pull both sides of the air inlet (cover) to separate it.

- The side with the **LG logo** at the center of the product is the front of the product.

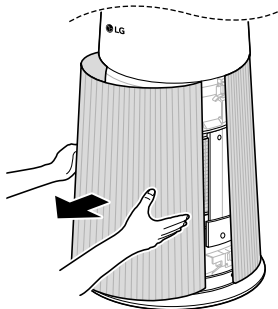

- 2 Push the sensor cover up.

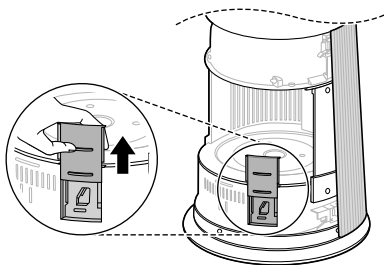

- 3 Clean the lens with a cotton swab soaked with water and clean it again with a dry cotton swab.

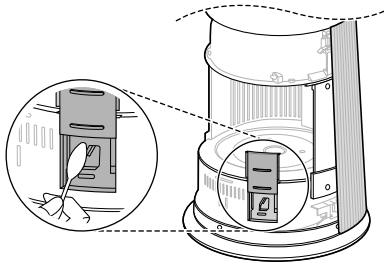

- 4 Close the sensor cover.

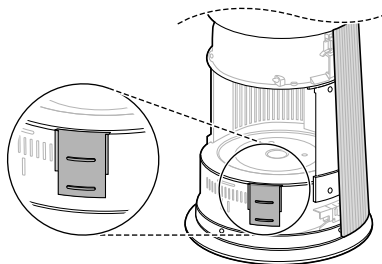

NOTE

- Do not wipe the sensor with any substances other than water. It may cause a appliance to malfunction.
- When opening or closing the sensor cover, a sound may be heard as a result of friction.

Cleaning the Filters

- 1 Separate the front and rear covers from the product.
 - Based on the front of the product with the **LG logo**, hold and gently pull both sides of the cover on top of the air inlet (cover) to separate it.

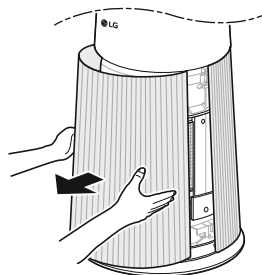

- 2** Using a vacuum cleaner or soft brush, remove any dust from the pre-filter surrounding the filter.

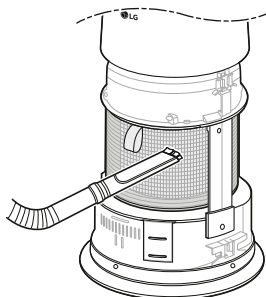

- Recommended regeneration period: About 3 hours every 2 months.

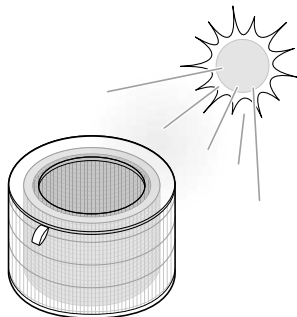

- 3** Separate the pre-filter from the total filter.
- How to separate the pre-filter: Check the Velcro of the pre-filter and carefully remove the pre-filter in order to avoid it being damaged.

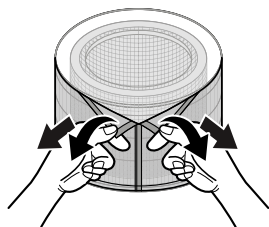

⚠ CAUTION

- Do not clean the filter with water. The service life of the filter may be reduced.
- Be careful not to damage the pre-filter when using a vacuum cleaner.
- Take caution because there is a risk of tearing or loss when separating or assembling the pre-filter.
- Be careful as the filter may be damaged if it is covered with liquid.

- 4** When you assemble the pre-filter, follow the reverse order of the separation procedure.

- 5** Regenerating harmful gases photocatalyst care.
- If you want to regenerate the functions of the photocatalyst deodorizing filter, expose it to direct sunlight.
 - The filter is regenerated by the light.
 - At night, expose the filter for about 3 hours using a light to regenerate it.

Replacing the Filters

- 1** Remove the cover of the product, and replace the filter.
- To avoid polluting the surroundings when replacing the filter, place newspaper on the floor before you remove the filter.

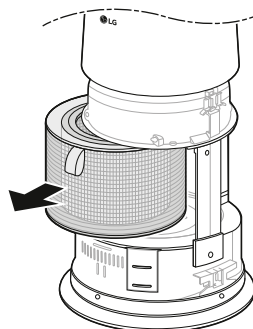

- 2 When you finish replacing the filter, turn off the Filter Replacement Notification.

Turning off Filter Replacement Notification

Press and hold the **Standby On/Off** and **Heating** buttons on the control panel for 3 seconds.

- The Filter Replacement Notification on the status panel is turned off and the time for Filter Replacement Notification is reset.

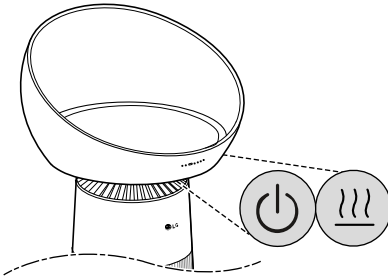

NOTE

- A notification is displayed when the filter needs to be replaced.
 - Use when replacing with a new filter.
-

Storage

Storing the Product

If the product will not be used for a long period of time, store it in a dry and shaded place.

- 1 Operate the product for one hour or more on a fine day.
 - This removes moisture and prevents molds from building-up inside the product.
- 2 Turn off the power and unplug it from the electrical outlet.
 - Wind the power cord around the bottom of the appliance.

- 3 Package the appliance to prevent the dust or foreign substance from entering the appliance. Store the packaged product in a dry shaded place.

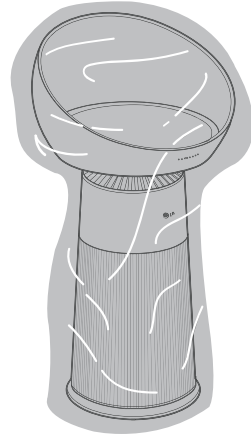

⚠ CAUTION

- Do not store the appliance at a humid place or at a place exposed to the direct sunlight. Otherwise the appliance may be deformed, malfunction or generate odor.
-

TROUBLESHOOTING

Before Calling for Service

Please check the following before calling for service. If the problem persists, contact your local service center.

Operation

Symptoms	Possible Cause & Solution
The product does not power on.	Is the power plug disconnected? <ul style="list-style-type: none"> Connect it to an outlet correctly.
	Did the electricity get cut off? <ul style="list-style-type: none"> Check the power to other products in the house.
	Are the main body of the product and the cat dome assembled properly? <ul style="list-style-type: none"> Assemble the main body of the product and the cat dome properly.
A noise occurs and the fan speed is low.	Has dust accumulated in the pre-filter? <ul style="list-style-type: none"> Clean the pre-filter.
	Has dust accumulated in the filter? <ul style="list-style-type: none"> Replace the filter.
Air purification is not performed properly.	Is the indoor pollution severe? <ul style="list-style-type: none"> Ventilate indoors before using the product.
	Has dust accumulated in the pre-filter? <ul style="list-style-type: none"> Clean the pre-filter.
	Has dust accumulated in the filter? <ul style="list-style-type: none"> Replace the filter.
	Are you using it in a place that is too spacious or too open? <ul style="list-style-type: none"> Use a product that suits the size of the room. Avoid well-ventilated places such as doors, windows, etc.
	Is there an obstacle nearby? <ul style="list-style-type: none"> Remove any nearby obstacles before operating the product.
	Is the product installed in a corner? <ul style="list-style-type: none"> Move the product and reinstall it.
The air quality light is continuously red.	Does the color not change even if it is moved to a clean room? <ul style="list-style-type: none"> Remove the power plug from the outlet and reconnect after 1 minute.
	Did you use a spray near the product? <ul style="list-style-type: none"> Do not use a spray near the product.

Symptoms	Possible Cause & Solution
The speed does not change.	<p>Is the Cat Relax mode set?</p> <ul style="list-style-type: none"> If the Cat Relax mode is set and your cat is in the cat dome, the speed cannot be adjusted.

Odor

Symptoms	Possible Cause & Solution
A strange odor comes out of the air outlet as well as the filter.	<p>Did you purchase the product recently?</p> <ul style="list-style-type: none"> This is the odor of activated charcoal, and is not harmful. This is similar to the odor you may experience in a brand new car. It will go away within a day following use.
	<p>Is the product used in a place with a lot of smoke or odors?</p> <ul style="list-style-type: none"> If the air purifier is operated after an air freshener, diffuser, or scented candle has been used, or interior work or wallpaper replacement have occurred, the filter may absorb and emit an odor. Ventilate the room first before using the product.
	<p>Does the filter have a bad smell?</p> <ul style="list-style-type: none"> The filter replacement cycle may vary depending on the usage environment. If there is an odor, replace the filter with a new one.
	<p>Is it in an environment in which food is prepared?</p> <ul style="list-style-type: none"> If you use the product for a long period of time where you cook or broil fish/meat, the filter lifespan may be significantly decreased. If possible, open a window for ventilation while cooking, and use the product to remove any odors left following ventilation.
	<p>Is it a humid environment?</p> <ul style="list-style-type: none"> The filter may emit an odor if used in a humid environment. Dry the filter in sunlight before use.

LG ThinQ

Symptoms	Possible Cause & Solution
The product and the smartphone cannot be connected through Wi-Fi.	<p>Is the Wi-Fi password used to connect to the smartphone correct?</p> <ul style="list-style-type: none"> Press the Settings button on your smartphone, and then find your Wi-Fi in the network list. Press and hold the button to select [Clear Network], and then proceed with product registration again from the beginning.
	<p>Is your smartphone using mobile data rather than Wi-Fi?</p> <ul style="list-style-type: none"> In the smartphone's settings, turn off Mobile Data, turn on Wi-Fi, and then register the product.

Symptoms	Possible Cause & Solution
The product and the smartphone cannot be connected through Wi-Fi.	Does the name (ID) of the wireless router contain special characters? <ul style="list-style-type: none">• Set the name (ID) of the wireless router as a combination of numbers and English letters. Wi-Fi connection may be difficult if you enter special characters.
	Is the frequency of the wireless router not 2.4 GHz? <ul style="list-style-type: none">• When connecting the product via Wi-Fi, only a 2.4 GHz network can be used. Set the wireless router to 2.4 GHz and then connect. To check the frequency of your wireless router, contact your Internet carrier or router manufacturer.
	Are the product and the wireless router too far apart? <ul style="list-style-type: none">• If the distance between the product and the wireless router is too great, the wireless signal may be weak, and the connection may not be smooth. Move the wireless router closer to the product.

APPENDIX

Information

APPLIANCE SPECIFICATIONS

- Appearance and specifications may vary without notice to improve the quality of the appliance.
- This product is not equipped with a gas sensor.

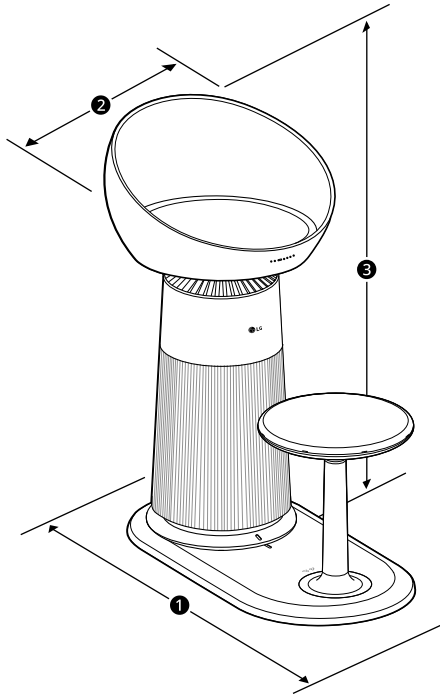

Name	AS25GCBZ0
Power	AC 220 - 240 V ~, 50/60 Hz
Exterior Dimensions (① x ② x ③)	710 mm x 422 mm x 800 mm

