



OWNER'S MANUAL

LG Digital Signage

(MONITOR SIGNAGE)

Please read this manual carefully before operating your set and retain it for future reference.

65EV5C-2
65EV5C-3
65EV5C-2E

www.lg.com

Copyright © 2018 LG Electronics Inc. All Rights Reserved.

TABLE OF CONTENTS

IMPORTANT PRECAUTIONS.....3

- Electrical Power Related Precautions.....3
- Precautions for installing the Product.....5
- Precautions for Moving the Product.....6
- Precautions for Using/Cleaning the Product....7
- Product Disposal (Only, Hg lamp used LCD Monitor).....7

LICENSES.....8

ASSEMBLY AND PREPARATION ..9

- STORAGE METHOD FOR PANEL PROTECTION..10
- Cautions for connecting Video Wall Panels12
- Installing on the Wall.....13

REMOTE CONTROL 15

MAKING CONNECTIONS..... 17

- Connecting to a PC.....17
- External Device Connection.....17
- Connect a USB Storage Device.....17
- Using the Input List19
- Connecting Multiple Products.....20

TROUBLESHOOTING..... 21

PRODUCT SPECIFICATIONS..... 24

WARNING: This equipment is compliant with Class A of CISPR 32. In a residential environment this equipment may cause radio interference.

IMPORTANT PRECAUTIONS

Please read these safety precautions carefully before using the product.

WARNING

Failure to follow those warnings may result in death, serious injury or damage to the product or other property.

CAUTION

If you ignore the caution message, you may be slightly injured or the product may be damaged.

WARNING

- Indoor Use Only.

Electrical Power Related Precautions

WARNING

- Use only the power cord supplied with the unit or another manufacturer's authorized cord.
 - Failure to do so may result in fire or electrical shock or damage to the product.
- Use only a properly grounded plug and receptacle.
 - If you do not you may be electrocuted or injured. Or the product might be damaged.
- Do not use a damaged or loose plug.
 - This may cause electrical shock or fire.
- Operate the display only from a power source(i.e. voltage) indicated in the product specification.
 - Otherwise the product can be damaged, fire can occur or you may be electrocuted. If you are not sure what type of power supply you have, consult a certified electrician.
- In the presence of thunder and lightning, never touch the power cord and signal cable because it can be very dangerous.
 - It can cause electric shock.
- Do not connect several extension cords, electrical appliances or electrical heaters to a single outlet. Use a power strip with a grounding terminal designed for exclusive use with the computer.
 - A fire can break out due to overheating.
- Do not touch the power plug with wet hands. Additionally, if the cord pin is wet or covered with dust, dry the power plug completely or wipe dust off before plugging in the cord.
 - You may be electrocuted due to excess moisture.

- If you don't intend to use the product for a long time, unplug the power cable from the product.
 - Layers of dust can cause a fire, or insulation deterioration can cause electric leakage, electric shock or fire.
- Insert the power plug firm so it cannot come loose.
 - A loose connection can cause fire.
- Hold the plug when pulling out the power cable. Do not pull the plug out by the wire. Do not bend the power cord with excessive force or put heavy objects on the power cord.
 - The power line can be damaged, which may cause electric shock or fire.
- Do not insert metal or other conductive materials into the product openings. Additionally, do not touch the power cable right after plugging into the wall input terminal.
 - You may be electrocuted.
- Use an appliance coupler as a disconnect device.
- Please make sure the device is installed near the wall outlet to which it is connected and that the outlet is easily accessible.
- Do not unplug the power cord while the product is in use.
 - Electrical shock can damage the product.
- As long as this unit is connected to the AC wall outlet, it is not disconnected from the AC power source even if the unit is turned off.

Precautions for installing the Product

WARNING

- Keep away from heat sources like heaters or open flames.
 - Electrical shock, fire, malfunction or deformation may occur.
- Keep the packing anti-moisture material or vinyl packing out of the reach of children.
 - Anti-moisture material is harmful if swallowed. If swallowed by mistake, force the patient to vomit and visit the nearest hospital. Additionally, vinyl packing can cause suffocation. Keep it out of the reach of children.
- Do not put heavy objects on the product or sit upon it.
 - If the product collapses or is dropped, you may be injured. Prevent Children from climbing or pulling on the unit.
- Do not leave the power or signal cable where someone can trip over it.
 - Pedestrians may become entangled in the cables and cause the device to become damaged causing electrical shock, fire, or serious injury.
- Install the product in a neat and dry place. Do not use near water.
 - Dust or moisture can cause electrical shock, fire or product damage.
- Do not add accessories that have not been designed for this display.
- If you smell smoke or other odors or hear a strange sound from the product unplug the power cord and contact LG Customer Service.
 - If you continue to use without taking proper measures, electrical shock or fire can occur.
- If you dropped the product or the case is broken, turn off the product and unplug the power cord.
 - If you continue to use without taking proper measures, electrical shock or fire can occur. Contact LG Customer Service.
- Do not drop an object on or apply impact to the product. Do not throw any toys or objects at the product.
 - It can cause injury to humans, problems to the product and damage the display.
- Keep out of reach of children and do not place toys near the product.
- Make sure the product ventilation hole is not blocked. Install the product more than 100 mm (3.9 inches) from the wall.
 - If you install the product too close to the wall, it may be deformed or fire can break out due to internal heat build-up.
- Do not cover the product with cloth or other material (eg. plastic) while plugged in.
 - The product can be deformed or fire can break out due to internal overheating.
- Place the product on a flat and stable surface that is large enough to support the product.
 - If the product is dropped, you may be injured or the product may be broken.
- Install the product where no Electromagnetic Interference occurs.
- Keep the product away from direct sunlight.
 - The product can be damaged.
- Do not place the product on the floor.
 - Small Children and others may trip over it.
- Do not install this product on a wall if it could be exposed to oil or oil mist.
 - This may damage the product and cause it to fall.
- For displays with glossy bezels the user should consider the placement of the display as the bezel may cause unwanted reflections from surrounding light and bright surfaces.

Precautions for Moving the Product

WARNING

- Make sure to turn off the product.
 - You may be electrocuted or the product can be damaged.
- Make sure to remove all cables before moving the product.
 - You may be electrocuted or the product can be damaged.
- When lifting or moving the product, do not hold it upside down while holding only the stand.
 - This may cause the product to fall resulting in damage or injury.
- Do not shock the product when moving it.
 - You may be electrocuted or the product can be damaged.
- Make sure the panel faces forward and hold it with both hands to move.
 - If you drop the product, the damaged product can cause electric shock or fire.
- Do not place the product face down.
 - This may damage the TFT-LCD screen.

Precautions for Using/Cleaning the Product

⚠ WARNING

- Do not attempt to disassemble, repair or modify the product yourself.
 - Fire or electric shock can occur.
 - Contact LG Customer Service for repair.
- When cleaning the product, unplug the power cord and scrub gently with a soft cloth to prevent scratching. Do not clean with a wet cloth or spray water or other liquids directly onto the product. An electric shock may occur. (Do not use chemicals such as benzene, paint thinners or alcohol.)
- Keep the product away from water.
 - Fire or electric shock accident can occur.
- Avoid high temperatures and humidity.
- Do not put or store flammable substances near the product.
 - There is a danger of explosion or fire.
- Keep the product clean at all times.
- Take a comfortable and natural position when working with the product.
- Take a regular break when working with the product for a long time.
- Do not press on the panel with a hand or sharp object such as nail, pencil or pen, or make a scratch on it.
- Keep proper distance from the product and rest from time-to-time.
 - Your vision may be impaired if you look at the product too closely or for too long.
- Set the appropriate resolution by referring to the User's Guide.
- Keep small accessories out of the reach of children.
- Displaying a still image for long time on the monitor may leave persistent image or stain on the monitor screen. To avoid this problem, use a screen saver and power off when this product is not used. Persistent image or stain caused by long time usage are not covered by the warranty on this product.
- Do not use products using high voltage around the Monitor. (ex. Electrical Swatter)
 - Monitor may have malfunction as its electrical shock.
- Spray water onto a soft cloth 2 to 4 times, and use it to clean the front frame; wipe in one direction only. Too much moisture may cause staining.
- Do not handle the panel without protective gear such as gloves, as the parts where the edges meet are very sharp.
- Always wear protective gear such as gloves when cleaning the panel as the parts where the edges meet are very sharp.

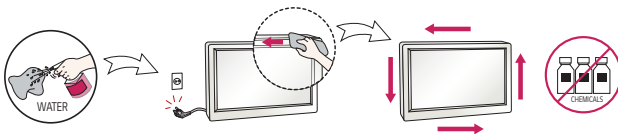

Product Disposal (Only, Hg lamp used LCD Monitor)

- The fluorescent lamp used in this product contains a small amount of mercury.
- Do not dispose of this product with general household waste.
- Disposal of this product must be carried out in accordance to the regulations of your local authority.

LICENSES

Supported licenses may differ by model. For more information of the licenses, visit www.lg.com.



The terms HDMI and HDMI High-Definition Multimedia Interface, and the HDMI logo are trademarks or registered trademarks of HDMI Licensing LLC in the United States and other countries.

ASSEMBLY AND PREPARATION

CAUTION

- Always use genuine components to ensure safety and product performance.
- The product warranty will not cover damage or injury caused by the use of counterfeit components.
- Connect the power cord to the product before you plug it into a wall outlet. Plugging the power cord into a wall outlet first may cause an electric shock, which can also damage the product.

NOTE

- The image shown may differ from the actual accessories.
- The accessories provided with your product may vary depending on the model or region.
- Product specifications or contents in this manual may be changed without prior notice due to upgrade of product functions.
- SuperSign Software & Manual
 - Downloading from the LG Electronics website.
 - Visit the LG Electronics website (<http://partner.lge.com>) and download the latest software for your model.
- The warranty will not cover any damage caused by using the product in an excessively dusty environment.

WARNING

- The product warranty does not cover any electrostatic damage to parts that may occur during product installation. Wear the appropriate gear that can prevent electrostatic discharge (ESD) when installing the product.

STORAGE METHOD FOR PANEL PROTECTION

Correct Method

- 1 If the product needs to be set upright, hold both sides of the product and make sure that the panel does not touch the floor.

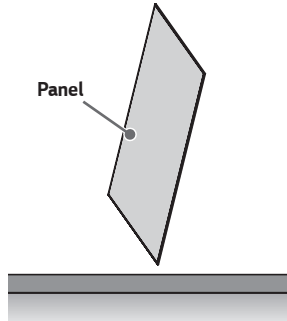

- 2 When laying down the product, lay a cushion on a flat floor. Put the product on it with the panel of the product facing down.

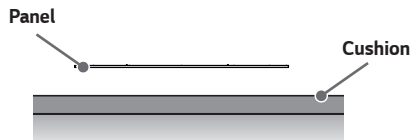

Incorrect Method

- 1 If the product is tilted onto the bezel, the bottom of the panel may be damaged.

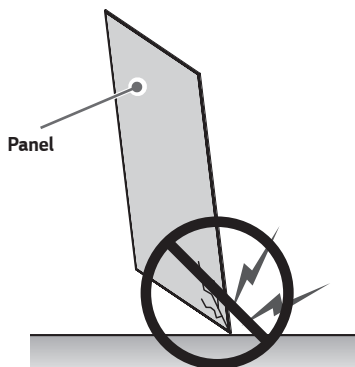

- 2 If the product is tilted onto the edge of the panel, the panel may be damaged.

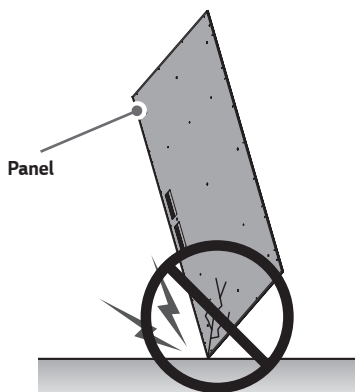

Cautions for connecting Video Wall Panels

- 1 Please use suction cups to secure the display while connecting.

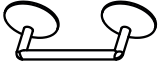

Maximum absorption	10 kg
Handle size	180 mm
Vacuum cup size	85 mm
Anti-static pad (Rubber or Silicon)	

- 2 Do not touch the back-side of panels.

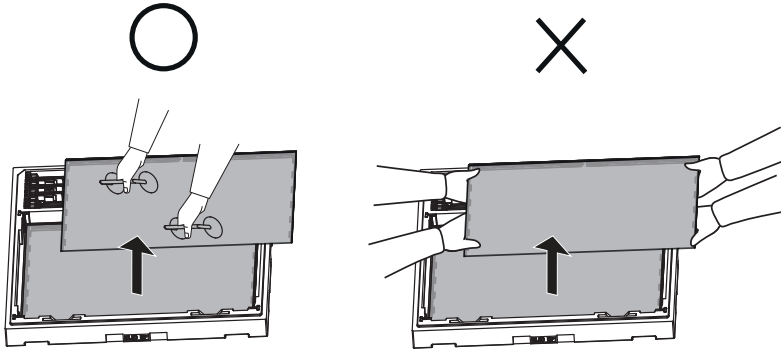

Installing on the Wall

When installing the monitor on the wall, use the screws provided with the product. Install the monitor at least 100 mm away from the surfaces on each side of the monitor to ensure sufficient ventilation. Refer to the installation manual for detailed instructions on installation.

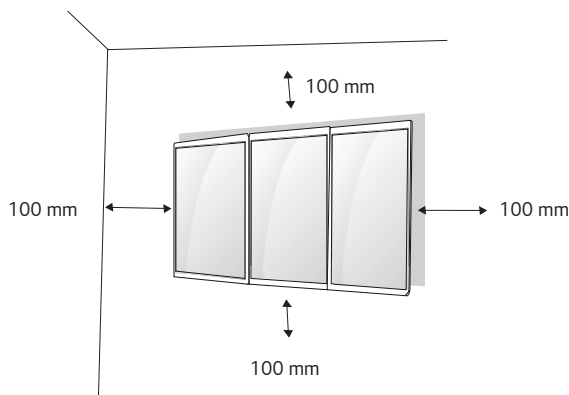

CAUTION

- Disconnect the power cord first, then move or install the monitor. Doing otherwise may cause electric shock.
- If you install the monitor on the ceiling or a slanted wall, it may fall and result in severe injury. Use the provided screws and wall mount, and contact your local dealer or qualified personnel.
- Use of non-standard screws may damage the product's interior.
- Use of non-standard screws may cause product damage or cause the product to fall. LG Electronics is not liable for any such accidents.
- Use screws of the following standards.
 - Wall mount screws: Diameter 5.0 mm (M5), length 10 mm or below, M5 screw head height 2.5 mm or below.

NOTE

- Do not install the product in a location with no ventilation (e.g., on a bookshelf or in a closet) or on a carpet or cushion. If there is no other option but to mount the product on the wall, make sure that sufficient ventilation is provided before installation.
 - Doing otherwise could result in fire due to high internal temperature.
- The illustrations are those of a general installation and may differ from the actual product.

Hanging the product safely on the wall **WARNING**

- If the product is not positioned in a sufficiently stable location, it can be potentially hazardous due to falling. Take note of the following precautions to prevent injury.
 - Only use furniture that can safely support the product.
 - Ensure the product is not overhanging the edge of the supporting furniture.
 - Do not place the product on tall furniture (e.g., cupboards or bookcases) without anchoring both the furniture and the product to a suitable support.
 - Do not place cloth or other materials between the product and supporting furniture.
 - Educate children about the dangers of climbing on the furniture to reach the product or its remote control.
 - Install on a wall where the anchor bolts used in product installation can be Secured in place.
 - Install in a location where the product is provided with safe support. (Concrete, plywood, MDF, etc.)
 - Installing the product on a gypsum wall may cause the wall to collapse.

 **CAUTION**

- Make sure that no one climbs on or hangs on the product.

REMOTE CONTROL

This manual describes how to operate the product using the remote control. Please read this manual carefully to use the monitor correctly.

To replace the batteries, open the battery cover, match the \oplus and \ominus ends of the replacement batteries (1.5 V AAA) to the label inside the compartment, and close the battery cover.

To remove the batteries, perform the above procedure in reverse. The image shown may differ from the actual accessories.

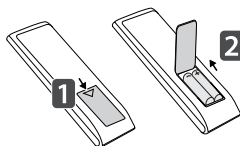

CAUTION

- Do not mix old and new batteries, as this may damage the remote control.
- Always point the remote control towards the monitor's infrared receiver.
- Some features of the remote control may not be supported in certain models.

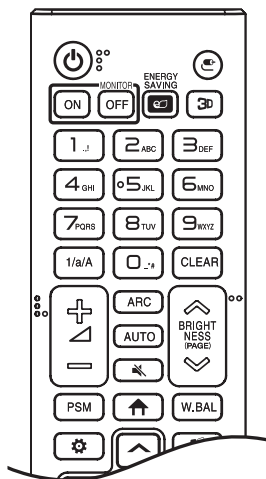

⏻ (POWER) Turns the monitor on or off.

MONITOR ON Turns the monitor on.

MONITOR OFF Turns the monitor off.

ENERGY SAVING e Adjusts the brightness of the screen to reduce energy consumption.

⏮ (INPUT) Selects the input mode.

3D Used for viewing 3D videos.

1/a/A Toggles between numerical and alphabetical mode.

Number and Alphabet Buttons Enters numerical or alphabetical characters depending on the settings.

CLEAR Deletes the entered numerical or alphabetical characters.

Volume Buttons Adjusts the volume.

ARC Selects the Aspect Ratio Mode.

AUTO Automatically adjusts the picture position and unstable images. (Only for RGB input.)

🔇 (MUTE) Mutes all sounds.

BRIGHTNESS Adjusts the brightness with the up/down buttons on the remote control.

PAGE This function is not supported by the current model.

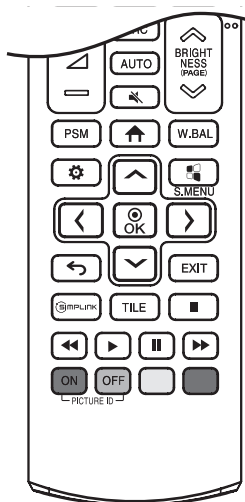

PSM Selects the Picture Status Mode.

↑ (HOME) Activates the Launcher.

W.BAL Press to enter the White Balance menu.

⚙️ (SETTINGS) Press to access the main menu and save or turn off settings.

Ⓜ️ S.MENU The Super Sign menu key.

Navigation Buttons Press to navigate the menus or options.

Ⓞ/Ⓚ Selects menus or options and confirms your input.

↶ (BACK) Allows you to move back one step in the user interaction function.

EXIT Exits all OSD tasks and applications.

ⓈIMPLINK Allows you to control various multimedia devices with ease using only the remote control through the SIMPLINK menu.

TILE Selects tile mode.

PICTURE ID ON/OFF When multiple monitors are connected, you can choose to control a specific monitor if the Set ID matches the Picture ID.

USB Menu Control Buttons Controls playback of media.

MAKING CONNECTIONS

You can connect various external devices to your monitor. Change the input mode and select the external device you want to connect. For more information about external device connections, see the user manual provided with each device.

Connecting to a PC

Some of the cables are not provided. This monitor supports the Plug and Play* feature.

* Plug and Play: a feature that enables a PC to recognize devices attached by the user without device configuration or user intervention when powering up.

External Device Connection

Some of the cables are not provided. Connect a HD receiver, DVD, or VCR player to the monitor and select an appropriate input mode.

For the best picture and sound quality, connecting external devices to your monitor using HDMI cables is recommended.

Connect a USB Storage Device

Devices using a power source such as the USB HDDs are not supported.

Some USB devices may not work if it does not meet the USB 3.0 standards.

NOTE

- It is recommended you use an HDMI connection for the best monitor image quality.
- To comply with the standard specifications of the product, make sure to use a shielded interface cable made with a ferrite core for the HDMI cable.
- If you turn the monitor on when it is cold, the screen may flicker. This is normal.
- Sometimes red, green, or blue spots may appear on the screen. This is normal.
- Use a high-speed HDMI®/™ cable. (3 m or less.)
- Use a certified cable with the HDMI logo attached. If you do not use a certified HDMI cable, the screen may not display any images or a connection error may occur.
- Recommended HDMI cable types
 - High-speed HDMI®/™ cables
 - High-speed HDMI®/™ Ethernet cables
- If you want to enable HDMI-PC mode, you must set PC/DTV to PC mode.
- You may experience a compatibility problem if you use HDMI-PC mode.
- Make sure the monitor's power cable is disconnected.
- If you wish to connect a gaming device to the monitor set, use the cable supplied with the gaming device.

CAUTION

- Connect the signal input cable and affix it by turning the screws clockwise.
- Do not press the screen with your finger for an extended period of time as this may result in temporary distortion of the screen.
- Avoid displaying static images on the screen for a long period of time to prevent image sticking. Use a screensaver if possible.
- Abnormalities can occur in video playback when using wireless devices near the monitor.

Using the Input List

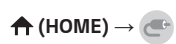

- HDMI → DISPLAYPORT → USB

Connecting Multiple Products

To use multiple products connected to each other, connect one end of the signal input cable (DP cable) to the DP Out connector of Monitor 1 and connect the other end to the DP In connector of a connected product.

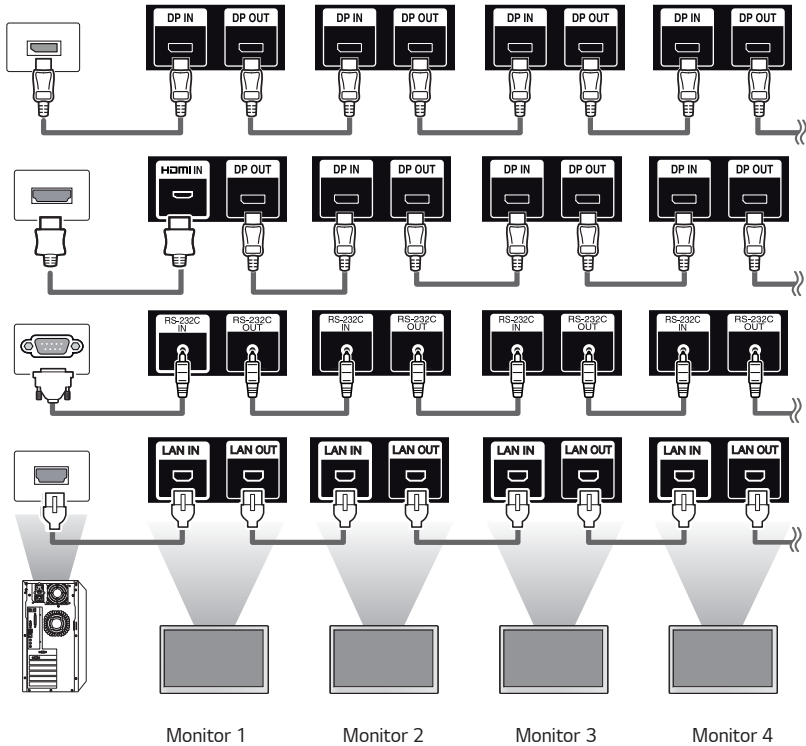

! NOTE

- If the signal cable connecting the product to your PC is too long, make sure to use a booster or optical cable.
- Daisy chaining the video output may be limited depending on the performance of the input device that supports HDCP.

TROUBLESHOOTING

No image is displayed.

Problem	Action
Is the product power cord connected?	<ul style="list-style-type: none"> • Check if the power cord is correctly plugged into the power outlet.
Does the "Invalid Format" message appear?	<ul style="list-style-type: none"> • The signal from the PC (Graphics card) is out of the vertical or horizontal frequency range of the product. Adjust the frequency range by referring to the Specifications in this manual.
Does the "No Signal" message appear?	<ul style="list-style-type: none"> • The signal cable between PC and product is not connected. Check the signal cable. • Access the input menu to check the input signal.

The "Unknown Product" message appears when the product is connected.

Problem	Action
Did you install the driver?	<ul style="list-style-type: none"> • Check if the Plug and Play function is supported by referring to the graphics card user manual.

The screen image looks abnormal.

Problem	Action
Is the screen position wrong?	<ul style="list-style-type: none"> • Check if the graphics card resolution and frequency are supported by the product. If the frequency is out of range, set to the recommended resolution in the [Control Panel] → [Display] → [Setting] menu. (The settings may differ depending on your operating system.)
The screen is displayed abnormally.	<ul style="list-style-type: none"> • The proper input signal is not connected to the signal port. Connect the signal cable that matches with the source input signal.

The screen color is strange.

Problem	Action
The screen has low color resolution (16 colors).	<ul style="list-style-type: none"> • Set the color resolution to 24 bits (true color) or higher. Use the [Control Panel] → [Display] → [Settings] → [Color Table] menu in Windows. (The settings may differ depending on your operating system.)
The screen color is unstable or mono-colored.	<ul style="list-style-type: none"> • Check the connection status of the signal cable. You can also re-insert your PC graphics card.
Do black spots appear on the screen?	<ul style="list-style-type: none"> • Several color pixels (red, green, blue, white, or black) may appear on the screen, which may be caused by the unique characteristics of OLED panels. It is not a malfunction of your OLED monitor.

The monitor does not work properly.

Problem	Action
The power suddenly turned off.	<ul style="list-style-type: none"> • Had the timer been set? • Check the power control settings. The power supply has been interrupted. • Are the fans functioning properly? <ul style="list-style-type: none"> - View the fan status in HOME → Information → Fan Status.

 **CAUTION**

- Image sticking may occur when displaying a fixed image for an extended period of time. It is recommended that you display videos for 12 hours or less per day to decrease the likelihood of image sticking.
- A few horizontal lines may appear on the screens while running the Clear Panel Noise feature (OFF-RS). This is normal, so there is no need for concern. Turning the power on while the Clear Panel Noise feature (OFF-RS) is operating may cause the product to malfunction. Turn the power on when the Power Indicator LED stops flashing and remains on.
- OFF-RS: Removes image sticking through TFT degradation compensation. Runs after 4 hours of use.
JB: Removes image sticking through OLED degradation compensation. Runs after 2000 hours of use.

PRODUCT SPECIFICATIONS

The product specifications below may change without prior notice to improve the features of the product.

The symbol ~ refers to alternating current, and ≋ refers to direct current.

OLED panel	Screen type	Thin Film Transistor (TFT) OLED panel
Operating conditions	Daily usage	12 hours (video)
Video signal	Maximum resolution	HDMI/DisplayPort: 3840 x 2160 @ 30 Hz - This may not be supported on some operating system or graphics card types.
	Recommended resolution	HDMI/DisplayPort: 3840 x 2160 @ 30 Hz - This may not be supported on some operating system or graphics card types.
	Horizontal frequency	HDMI/DisplayPort: 30 kHz to 83 kHz
	Vertical frequency	HDMI/DisplayPort: 23 Hz to 71 Hz
	Synchronization	Digital
Input/output	HDMI IN, DP IN, DP OUT, USB 3.0 IN 5 V ≋ 0.9 A, LAN IN, LAN OUT, IR IN, RS-232C IN/OUT	
Embedded battery	Applied	
Environmental conditions	Operation temp.	0 °C to 40 °C (32 °F to 104 °F)
	Operating humidity	10 % to 80 %
	Storage temp.	-20 °C to 60 °C (-4 °F to 140 °F)
	Storage humidity	5 % to 95 %
OLED panel	Pixel pitch	0.372 mm (H) x 0.372 mm (V)
Power	Rated power	AC 100-240 V to 50/60 Hz 4.5 A
	Power consumption (1x1, one side)	On Mode: 230 W (Typ.) Energy Saving (HDMI, DisplayPort): ≤ 3.0 W Off Mode: ≤ 0.5 W
	Dimensions (Width x Height x Depth) / Weight	Display 65EV5C-3: 2452 mm x 1450.5 mm x 7.9 mm / 78.9 kg (96.5 po x 57.1 po x 0.3 po / 173.9 lb) 65EV5C-2: 1639 mm x 1450.5 mm x 7.9 mm / 52.6 kg (64.5 po x 57.1 po x 0.3 po / 115.9 lb)
	Main box	423 mm x 390.2 mm x 24.2 mm (16.6 po x 15.3 po x 0.95 po)
	PSU box	523 mm x 243 mm x 56 mm (20.5 po x 9.5 po x 2.2 po)

[Unit: mm]

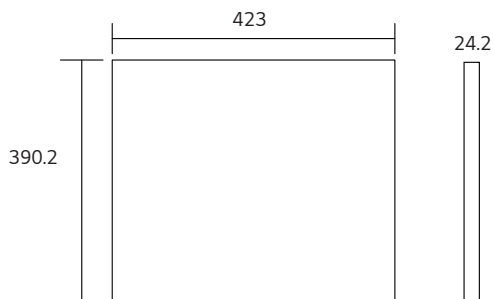
Main box**PSU box**

Display

[Unit: mm]

65EV5C-2 (1 x 2)

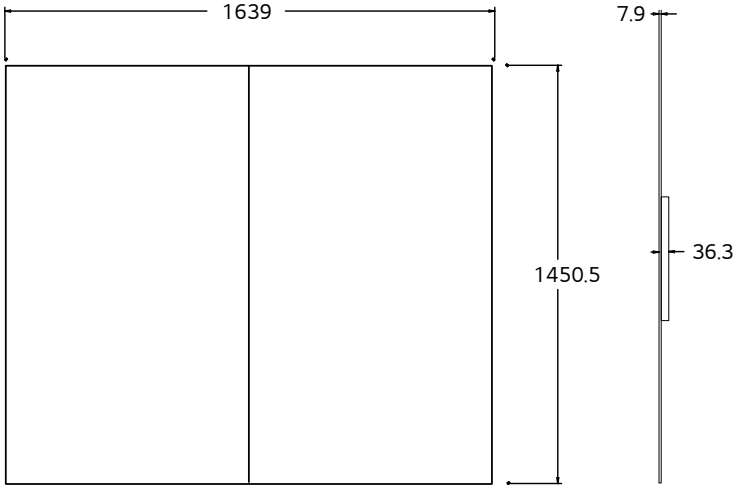

65EV5C-3 (1 x 3)

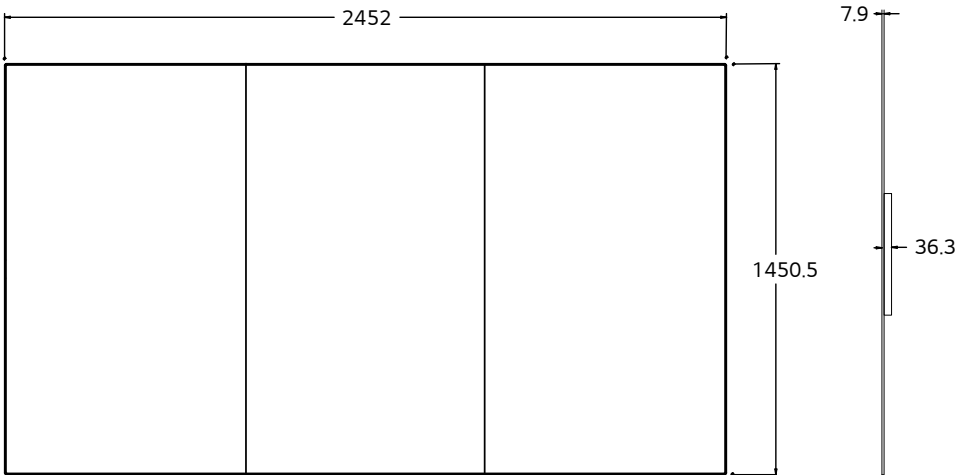

HDMI/DisplayPort (PC) supported modes

Resolution	Horizontal Frequency (kHz)	Vertical Frequency (Hz)	
800 x 600	37.879	60.317	
1024 x 768	48.363	60	
1280 x 720	44.772	59.855	
1366 x 768	47.712	60	
1280 x 1024	63.981	60.02	
1920 x 1080	67.5	60	
3840 x 2160	67.5	30	Only applies to HDMI, DisplayPort.

HDMI/DisplayPort (DTV) supported modes

Resolution	Horizontal Frequency (kHz)	Vertical Frequency (Hz)
576/50p	31.25	50
720/50p	37.5	50
720/60p	45	60
1080/50i	28.1	50
1080/60i	33.75	60
1080/50p	56.25	50
1080/60p	67.432	59.94
1080/60p	67.5	60
2160/30P	67.5	30

! NOTE

- PC resolutions available for the Input Label option in HDMI input modes: 640 x 480 / 60 Hz; 1280 x 720 / 60 Hz; 1920 x 1080 / 60 Hz; DTV resolutions: 480p, 720p and 1080p.
- Vertical frequency: To enable the user to view the monitor display, the screen image must change dozens of times every second like a fluorescent lamp. The vertical frequency or refresh rate is the number of times the image display is repeated per second. The unit is Hz.
- Horizontal frequency: The time it takes to display one horizontal line is called the horizontal interval. When 1 is divided by the horizontal interval, the number of horizontal lines displayed every second can be tabulated as the horizontal frequency. The unit is kHz.



Make sure to read the Safety Precautions before using the product.

The model and serial numbers of the SET are located on the back and one side of the SET. Record it below should you ever need service.

MODEL _____

SERIAL _____

Temporary noise is normal when powering ON or OFF this device.



USER GUIDE

LG Digital Signage

(MONITOR SIGNAGE)

Please read this manual carefully before operating your set and retain it for future reference.

webOS 3.0

TABLE OF CONTENTS

USER SETTINGS3

- Main Menu Settings.....3
- Picture Settings
- Sound Settings
- Network Settings
- General Settings

ENTERTAINMENT 15

- Using Multimedia Features..... 15
 - Connecting USB/SD Storage Devices
- Photo & Video..... 18
 - Supported Photo & Video Files
 - Viewing Photos and Videos
 - Scheduled Playing
 - Export
 - Delete
- Music22
 - Supported Music Files
 - Playing Music
 - Delete
- SuperSign Contents.....23
- Information23
- Local Contents Scheduler24
 - Setting a Scheduled Playing
- Screen Share.....25
 - Configuring WiDi (Wireless Display)
- Group Manager.....26
- Leveler Tool.....28
- Control Manager.....29
 - How to Use
 - Follow the steps below if you encounter issues with your security certificate while attempting to access.
- Multi-Screen.....34
- PICTURE ID Settings.....35

IR CODES 36

TO CONTROL MULTIPLE PRODUCTS..... 38

- Connecting the Cable.....38
- Communication Parameter39
- Command Reference List40
- Transmission/Reception Protocol44

To obtain the source code under GPL, LGPL, MPL, and other open source licenses, that is contained in this product, please visit <http://opensource.lge.com>.

In addition to the source code, all referred license terms, warranty disclaimers and copyright notices are available for download.

LG Electronics will also provide open source code to you on CD-ROM for a charge covering the cost of performing such distribution (such as the cost of media, shipping, and handling) upon email request to opensource@lge.com.

This offer is valid for a period of three years after our last shipment of this product. This offer is valid to anyone in receipt of this information.

! NOTE

- The software-related contents may be changed without prior notice due to upgrade of the product functions.
- Some features described in the User Guide may not be supported in certain models.
- SNMP 2.0 is supported.

USER SETTINGS

Main Menu Settings

Picture Settings

To Select Picture Mode

SETTINGS /  →  → [Picture] → [Picture Mode Settings] → [Picture Mode]

Select the picture mode that is best suited to the video type.

- [Vivid]: Adjusts the video image for a retail environment by enhancing the Contrast, Brightness, and Sharpness.
- [Standard]: Adjusts the video image for a normal environment.
- [APS]: APS (Auto power saving) mode reduces power consumption by dimming control.
- [Cinema]: Optimizes the video image for watching movies.
- [Sports]: Optimizes the video image for watching sports. Even fast actions such as kicking or throwing a ball are rendered clearly on the screen.
- [Game]: Optimizes the video image for playing videogames.
- [Photo]: Optimizes the screen for viewing photos. (This feature is available only with certain models.)
- [Expert]/[Calibration]: Allows an expert, or anyone interested in high quality pictures, to manually tune the picture for the best picture quality.

! NOTE

- Depending on the input signal, the available Picture modes may differ.
- [Expert] is an option that allows a picture quality expert to fine-tune the picture quality using a specific image. Thus, it may not be effective for a normal picture.

To fine-tune the picture mode

SETTINGS /  →  → [Picture] → [Picture Mode Settings] → [Customize]

- [Backlight]/[OLED Light]: Adjusts the brightness of the screen by controlling the LCD backlight. The closer the value is to 100, the brighter the screen is.
- [Contrast]: Adjusts the difference between the light and dark areas of the picture. The closer the value is to 100, the greater the difference is.
- [Brightness]: Adjusts the overall brightness of the screen. The closer the value is to 100, the brighter the screen is.
- [Sharpness]: Adjusts the sharpness of the edges of objects. The closer the value is 50, the clearer and the sharper the edge becomes.
- [H Sharpness]: Adjusts the sharpness of the contrast edges on the screen from a horizontal point of view.
- [V Sharpness]: Adjusts the sharpness of the contrast edges on the screen from a vertical point of view.
- [Color]: Softens or deepens the tints on the screen. The closer the value is 100, the deeper the colors become.
- [Tint]: Adjusts the balance between red and green levels displayed on the screen. The closer the value is to Red 50, the deeper the color red becomes, and the closer the value is to Green 50, the deeper the color green becomes.
- [Color Temperature]: Adjusts the tints of the screen to evoke feelings of warmth or coolness.
- [Advanced Controls]/[Expert Control]: Customizes the advanced options.
 - [Dynamic Contrast]: Optimizes the difference between the light and dark parts of the screen according to the brightness of the image.
 - [Super Resolution]: Sharpens the blurry or indistinguishable parts of the picture.
 - [Color Gamut]: Selects the range of colors to display.
 - [Dynamic Color]: Adjusts the tint and saturation of the image for a more vivid and lively display.
 - [Edge Enhancer]: Provides much sharper and clearer edges to the picture.
 - [Color Filter]: Accurately adjusts color and tint by filtering a specific color area of RGB space.
 - [Preferred Color]: Adjusts the skin tint, grass tint, and sky tint to your preference.
 - [Gamma]: Adjusts the medium brightness of the image.
 - [White Balance]: Adjusts the overall tint of the picture to your preference. In Expert mode, you can fine-tune the picture using the Method/Pattern options.
 - [Color Management System]: Experts use the color management system when they adjust the colors by using the test pattern. The color management system allows you to make an adjustment by selecting from among 6 different color spaces (Red/Yellow/Blue/Cyan/Magenta/Green) without affecting other colors. You may not see tints change in a normal picture even after adjustment.

- [Picture Options]: Customizes the picture options.
 - [Noise Reduction]: Removes irregularly generated tiny dots for a clear picture.
 - [MPEG Noise Reduction]: Reduces the noise produced while creating digital video signals.
 - [Black Level]: Adjusts the black level of the picture to correct the brightness and contrast of the picture. (Recommended settings according to input signal: RGB 0–255: High, RGB 16–235: Low, YCbCr: Low)
 - [Real Cinema]: Optimizes the video image for a cinematic look.
 - [Motion Eye Care]: Reduces eye fatigue by adjusting brightness levels and lessening blurriness based on the displayed image. (Only applies to certain models.)
 - [LED Local Dimming]: Brightens the brighter parts of the image and darkens the darker parts, maximizing contrast. Turning this feature off may lead to increased power consumption. (Only applies to certain models.)
 - [TruMotion]: Reduces image shaking and image sticking that can occur with moving images.
- [Reset]: Reset the picture settings. Because the picture settings are reset according to the monitor's picture mode, please select the picture mode before resetting the picture settings.

! NOTE

- You can adjust advanced settings only in the [User] mode.
- Depending upon the input signal or the selected picture mode, the available options may differ.

To set the aspect ratio

(Some features may not be supported in certain models.)

SETTINGS /  →  → [Picture] → [Aspect Ratio]

Changes the aspect ratio to view the image in its optimal size.

- [16:9]: Displays the image with a 16:9 aspect ratio.
- [Just Scan]: Displays the image in the original size without cutting off the edges. Original is available in HDMI (720p or higher) mode. (On 58:9 models, this option can be selected regardless of the input signal.)
- [Original]: Automatically changes the aspect ratio to 4:3 or 16:9 depending on the input video signal.
- [4:3]: Displays the image with a 4:3 aspect ratio.
- [58:9]: Displays the screen with a 58:9 aspect ratio.
- [Vertical Zoom]: Adjusts the height and vertical position of the displayed image.
- [All-Direction Zoom]: Adjusts the horizontal/vertical/diagonal dimensions and horizontal/vertical position of the displayed image.

! CAUTION

- If a fixed image is displayed on the screen for a long period of time, it will be imprinted and become a permanent disfigurement on the screen. This image burn or burn-in is not covered by the warranty.
- If the aspect ratio is set to [4:3] for a long period of time, image burn may occur on the letterboxed area of the screen.
- The options may differ depending on the model.
- Depending on the input signal, the available aspect ratio may differ.
- When you adjust [Vertical Zoom] or [All-Direction Zoom], the screen may flicker for some input signals.

To use the Energy Saving function

SETTINGS /  →  → [Picture] → [Energy Saving]

Reduces power consumption by adjusting peak screen brightness.

- [Auto]: Adjusts the brightness of the monitor according to ambient light. (This feature is available only with certain models.)
- [Off]: Disables the Energy Saving mode.
- [Minimum]/[Medium]/[Maximum]: Uses the Energy Saving according to the Energy Saving level specified for your monitor.
- [Screen Off]: Turns off the screen. You will only hear audio. You can turn on the screen again by pressing any button on the remote control except the power button.

! NOTE

- To revert to the default settings, either go to [General] → [Reset to Initial Settings] or [Installation Menu] → [Signage Setup] → [Factory Reset].

To use the Smart Energy Saving function

(Only applies to certain models.)

SETTINGS /  →  → [Picture] → [Smart Energy Saving]

According to picture brightness, the brightness of the monitor will be adjusted automatically to save energy.

- [Off]: Disables the Smart Energy Saving function.
- [On]: Enables the Smart Energy Saving function.

! NOTE

- To revert to the default settings, either go to [General] → [Reset to Initial Settings] or [Installation Menu] → [Signage Setup] → [Factory Reset].

Configuring the OLED Display

(For OLED models only)

SETTINGS /  →  → [Picture] → [OLED Panel Settings]

- [Clear Panel Noise]: Corrects issues that may arise when the screen is turned on for a long period of time.

To use the SCREEN(RGB-PC) function

(Only applies to certain models.)

SETTINGS /  →  → [Picture] → [Screen(RGB-PC)]



Customizes the PC display options in RGB mode.

- [Set Automatically]: Sets to adjust the screen position, clock, and phase automatically. The displayed image may be unstable for a few seconds while the configuration is in progress.
- [Resolution]: Selects a proper resolution.
- [Position]/[Size]/[Phase]: Adjusts the options when the picture is not clear, especially when characters are shaky, after the auto configuration.
- [Reset]: Restores the options to the default setting.

Sound Settings

- Only applies to certain models.



To select a Sound Mode

SETTINGS /  →  → [Sound] → [Sound Mode]

The best sound quality will be selected automatically depending on the video type currently being watched.

- [Standard]: This sound mode works well for content of all types.
- [Cinema]: Optimizes sound for watching movies.
- [Clear Voice III]: Enhances voices so they can be heard more clearly.
- [Sports]: Optimizes sound for watching sports.
- [Music]: Optimizes sound for listening to music.
- [Game]: Optimizes sound for playing videogames.

To use the Sound Effects function

SETTINGS /  →  → [Sound] → [Sound Mode Settings]

- [Equalizer]: Manually adjust sound by using the equalizer.
- [Balance]: Adjust the output volume for the left speaker and the right speaker.
- [Reset]: Reset the sound settings.

Selecting Sound Output Device

SETTINGS /  →  → [Sound] → [Sound Out]

- [Signage Speaker]: You can output sound through the signage monitor's internal speakers. This feature is available only for models with built-in signage speakers.
- [LG Sound Sync / Bluetooth]: You can connect Bluetooth audio devices or Bluetooth headsets wirelessly to enjoy richer sound from the signage monitor conveniently.

NOTE

- Some recently connected devices may automatically attempt to reconnect to the Signage monitor when it is turned on.
- It is recommended that you set LG audio devices that support LG Sound Sync to LG TV mode or LG Sound Sync mode before connecting.
- This feature is only available on certain models.
- Press [Device Selection] to view the devices that are or that can be connected and connect other devices.
- You can use the signage remote control to adjust the volume of the connected device.
- If the audio device fails to connect, check that it is switched on and available for connection.
- Depending on the type of Bluetooth device, the device may not connect correctly or a malfunction such as unsynchronized video and audio may occur.
- Sound may stutter or sound quality may be reduced if:
 - The Bluetooth device is too far from the signage monitor.
 - There are objects obstructing the Bluetooth device and signage monitor.
 - The device is used in proximity to other radio devices such as a microwave oven or wireless LAN router.

To select a Volume Increase Rate,

SETTINGS /  →  → [Sound] → [Volume Mode] → [Volume Increase Amount]

You can set the volume range by selecting any of Low/ Medium/ High.

To sync audio with video

SETTINGS /  →  → [Sound] → [AV Sync Adjustment]

- [Signage Speaker]: Adjusts the sync between video and audio coming from external speakers, such as those connected to the digital audio output port, LG audio equipment, or headphones. From the default value, the closer the value is to -, the faster the sound output becomes, and the closer the value is to +, the slower the sound output becomes.
- [Bypass]: Audio coming from external devices without delay. Audio may be outputted earlier than video due to the processing time for video that is inputted into the monitor.



Network Settings

To Set a Signage Monitor Name

SETTINGS /  →  → [Network] → [Signage Name]

You can set a name for Signage Monitor that will be used on the network by using the on-screen keyboard.

To Set Your Wired Network

SETTINGS /  →  → [Network] → [Wired Connection (Ethernet)]

- Connecting to a wired network: Connect your monitor to a local area network (LAN) via the LAN port, and configure the network settings. Only wired network connections are supported. After making a physical connection, a small number of networks may require the display network settings to be adjusted. For most networks, the display will automatically make a connection without any adjustments. For detailed information, contact your Internet provider or consult your router manual.

Setting a Wireless Network

(Only applies to certain models.)

SETTINGS /  →  → [Network] → [Wi-Fi Connection]

If you have set the monitor up for a wireless network, you can check and connect to the available wireless Internet networks.



- [Add a Hidden Wireless Network]: If you input the name of network directly, you can add a wireless network.
- [WPS PBC connection]: Press the button on the wireless router that supports PBC to easily connect to the router.
- [WPS PIN Code connection]: Enter the PIN number in the web page of the PIN-supporting wireless router to connect to the router in a simple manner.
- [Wi-Fi advanced settings]: Manually input the network information to connect to a wireless network. When a usable wireless network does not appear, press Wi-Fi advanced settings. You will be able to add a network.

NOTE

- For models that support Wi-Fi Dongle, the Wireless Network Connection menu is enabled only when a Wi-Fi Dongle is connected to the product.
- When connected to a network that supports IPv6, you can select IPv4 / IPv6 in the wired / wireless network connection. But, IPv6 connection only supports automatic connection.

Setting up a SoftAP

(Only applies to certain models.)

SETTINGS /  →  → [Network] → [SoftAP]

If you set up a SoftAP, you can connect many devices via a Wi-Fi connection without a wireless router and use wireless Internet.

- To use SIGNAGE, you must have an Internet connection.
- You cannot use the SoftAP feature and the Screen Share feature at the same time.
- On models that support Wi-Fi dongles, the SoftAP menu is enabled only when a Wi-Fi dongle is connected to the product.
- SoftAP connection information
 - SSID: A unique identifier necessary to make a wireless Internet connection
 - Security key: The security key you enter to connect to the desired wireless network
 - Number of connected devices: Shows the number of devices currently connected to your Signage device via a Wi-Fi connection. Up to 10 devices are supported.

Tips for Network Setting

- Use a standard LAN cable (Cat5 or higher with a RJ45 connector) with this display.
- Many network connection problems during set-up can often be fixed by re-setting the router or modem. After connecting the display to the home network, quickly power off and/or disconnect the power cable of the home network router or cable modem, then power on and/or connect the power cable again.
- Depending on the Internet Service Provider (ISP), the number of devices that can receive Internet service may be limited by the applicable terms of service. For details, contact your ISP.
- LG is not responsible for any malfunction of the display and/or the Internet connection feature due to communication errors/malfunions associated with your Internet connection, or other connected equipment.
- LG is not responsible for problems with your Internet connection.
- You may experience undesired results if the network connection speed does not meet the requirements of the content being accessed.
- Some Internet connection operations may not be possible due to certain restrictions set by the Internet Service Provider (ISP) supplying your Internet connection.
- Any fees charged by an ISP including, without limitation, connection charges are your responsibility.

! NOTE

- If you want to access the Internet directly on your display, the Internet connection should always be on.
- If you cannot access the Internet, check the network conditions from a PC on your network.
- When you use Network Setting, check the LAN cable or check if DHCP in the router is turned on.
- If you do not complete the network settings, the network may not function correctly.

! CAUTION

- Do not connect a modular telephone cable to the LAN port.
- Since there are various connection methods, please follow the specifications of your telecommunication carrier or Internet Service Provider.
- Network Setting menu will not be available until the display is connected to a physical network.

Tips for Wireless Network Setting

- Wireless networks can be subject to interference from other devices operating at a frequency of 2.4 GHz (wireless phones, Bluetooth devices or microwave ovens). There may also be interference from devices with a frequency of 5 GHz, same as other Wi-Fi devices.
- The surrounding wireless environment can cause the wireless network service to run slowly.
- If you do not turn off the entire local home network, network traffic may occur on some devices.
- For an AP connection, an access point device that supports wireless connection is required and the wireless connection feature must be enabled on the device. Contact your service provider regarding availability of wireless connection on your access point.
- Check the SSID and security settings of the AP for AP connection. Refer to the appropriate documentation for SSID and security settings of the AP.
- Invalid settings on network devices (wired/wireless line sharer, hub) can cause the monitor to run slowly or not operate properly. Install the devices correctly according to the appropriate manual and set the network.
- Connection method may differ according to the AP manufacturer.

General Settings



To configure the language

SETTINGS /  →  → [General] → [Menu Language]

Select one of the languages on the menu displayed on the screen.

- [Menu Language]: Sets a language for Signage.

Setting up the keyboard language

SETTINGS /  →  → [General] → [Keyboard Languages]

Select the language you wish to show on the keyboard.

- [Keyboard Languages]: Sets the keyboard language.

To set the time/date

SETTINGS /  →  → [General] → [Time & Date]

You can check or change the time.

- [Set Automatically]: You can set Time and Date.
- [Daylight Saving Time]: You can set Start Time and End Time for Daylight Saving Time. The DST start/end settings work only when you set them more than one day apart from each other.
- [NTP Server Setting]: Allows you to set other NTP servers other than the basic NTP server. (Only applies to certain models.)
- [Time zone]: You can change the settings for Continent, Country/Territory, and City.

To turn your monitor on or off automatically

SETTINGS /  →  → [General] → [Timers]



You can set the On/Off Timer for your monitor.

- [On Timer]: You can set the time when your monitor turns on.
- [Off Timer]: You can set the time when your monitor turns off.
- [No Signal Power Off (15Min)]: When there is no input source, the monitor will automatically turn off after 15 minutes. If you don't want it to turn off automatically, set No Signal Power Off to [Off].
- [Auto Power Off]: When there is no key input, the monitor will automatically turn off.

! NOTE

- On Time/Off Time can be saved for up to seven schedules; the monitor is turned on or off at the preset time in the schedule list. If multiple preset times are stored in the schedule list, this function works at the nearest time from the current time.
- Once the on or off time is set, these functions operate daily at the preset time.
- The scheduled power-off function works properly only when the device time is set correctly.
- When the scheduled power-on and power-off times are the same, the power-off time has priority over the power-on time if the set is turned on, and vice versa if the set is turned off.

Configuring Set ID

SETTINGS /  →  → [General] → [Set ID]



- [Set ID](1 to 1000): Assigns a unique Set ID number to each product when several products are connected for display. Assign numbers ranging from 1 to 1000 and exit the option. You can control each product separately by using the Set ID you assigned to each product.
- [Auto Set ID]: Automatically assigns a unique Set ID number to each set when several products are connected for display.
- [Reset Set ID]: Resets the Set ID of the product to 1.

NOTE

- When using automatic ID settings, the IR signal only needs to be transmitted to the first set. Malfunctions could occur when the IR signal is transmitted to other sets.

Using Tile Mode

(Only applies to certain models.)

SETTINGS /  →  → [General] → [Tile Mode]

You can configure the integrated screen in the same way as each screen is configured.

- [Row](1 to 15): Sets the number of tile rows.
- [Column](1 to 15): Sets the number of tile columns.
- [Tile ID](1 to 225): Sets the Tile ID. The ID you selected will be displayed on the screen.
- [Natural]: For a more natural display, the image is partly omitted to account for the distance between the screens.
- [Natural Size]: Sets the distance between screens for Natural mode.
- [Reset]: Resets the tile settings to 2 x 2.

NOTE

- If Tile mode is set to On, Smart Energy Saving mode will be disabled to provide the same picture quality as other displays.
- The maximum number of columns and lines that can be set may differ by model.
- To use this function, the product:
 - Must be displayed with other products.
 - Must be operated by connecting to each display via a distributor or DP daisy chain.
 - Tile Mode: Horizontal x Vertical (Horizontal = 1 to 15, Vertical = 1 to 15)
 - 15 x 15 is available

Configuring the Dual-View Screen

(For double-sided flat OLED models only)

SETTINGS / ⚙️ → ⋮ → [General] → [Dual-View Screen Setting]

- [Front Screen Name]: Sets the name of the front screen.
- [Back Screen Name]: Sets the name of the back screen.
- [Screen Swap]: Swaps the images on the front and back side of the screens.
- [Screen Mirroring]: Copies the image of the current screen to the opposite screen.
- [Screen Off]: Turns off the front or back screen.
- [Clone All Settings]: Copies all settings for the front screen to those for the back screen. This option is only enabled for the front screen.

To reset your monitor settings

SETTINGS / ⚙️ → ⋮ → [General] → [Reset to Initial Settings]

Resets all monitor settings.

Using UHD Deep Color

(For Ultra HD models only)

SETTINGS / ⚙️ → ⋮ → [General] → [UHD Deep Color]

If you connect an HDMI or DP device to one of the Deep Color adjustable ports, you can select between Ultra Deep Color On (6G) or Off (3G) in the UHD Deep Color settings menu.

If a compatibility issue occurs with the graphics card when the Deep Color option is set to On at 3840 x 2160 @ 60 Hz, set the Deep Color option to Off.

- HDMI and DP specifications may vary depending on the input port. Check the specifications of each device before connecting.
- HDMI input ports 1 and 2 are best suited for specifications for high definition 4K @ 60 Hz (4:4:4, 4:2:2) video. However, video or audio may not be supported depending on the specifications of the external devices. If this is the case, please connect to a different HDMI port.

ENTERTAINMENT

Using Multimedia Features

Connecting USB/SD Storage Devices

Connect a USB storage device such as a USB flash memory, SD storage devices or an external hard drive to the display and use multimedia features.

CAUTION

- Do not turn the monitor off or remove the USB storage device while Photo & Video or Music is playing.
- Back up files you have saved on a USB storage device frequently, as loss or damage to the files may be not covered by the warranty.

Tips for using USB/SD storage devices

- Only a USB storage device can be recognized.
- A USB device does not work effectively when it is connected via a USB hub.
- A USB storage device using an automatic recognition program may not be recognized.
- A USB storage device using its own driver may not be recognized.
- The recognition speed of a USB storage device may depend on each device.
- Please do not turn off the display or unplug the USB storage device when the connected device is working. If the USB storage device is suddenly disconnected, the stored files or the device itself may be damaged.
- Please do not connect a USB storage device which was modified to work on a PC. The device may cause the monitor to malfunction or the content fail to be played. Use only a USB storage device which contains normal music, image or video files.
- A USB storage device formatted as a utility program not supported by Windows may not be recognized.
- A USB storage device (over 0.5 A) which requires an external power supply must be connected to a power supply separately. If it is not, the device may not be recognized.
- Please connect the USB storage device using the cable provided by the device manufacturer.
- Some USB storage devices may not be supported or operate smoothly.
- File alignment method of USB storage devices is similar to that of Window XP and filenames can recognize up to 100 English characters.
- Back up important files regularly as data stored on a USB storage device may be damaged. We will not be responsible for any data loss.
- If the USB HDD does not have an external power source, the USB device may not be detected. To ensure the device is detected, connect the external power source.
 - Please use a power adapter for an external power source. We do not provide a USB cable for an external power source.

- If your USB storage device has multiple partitions, or if you use a USB multi-card reader, you can use up to four partitions or USB storage devices.
- If a USB storage device is connected to a USB multi-card reader, its volume data may not be detected.
- If the USB storage device does not work properly, disconnect and reconnect it.
- Detection speed differs from device to device.
- If the USB storage device is connected in Standby Mode, the specific hard disk will automatically be loaded when the display is turned on.
- The recommended capacity is 1 TB or less for a USB external hard drive and 32 GB or less for USB memory stick.
- Any device with more than the recommended capacity may not work properly.
- If a USB external hard drive with an "Energy Saving" function does not work, try turning the hard drive off and on again.
- USB storage devices below USB 2.0 are also supported but may not function correctly in the Videos.
- A maximum of 999 sub-folders or files can be recognized under one folder.
- The SDHC type for SD cards is supported. To use an SDXC card, format it to the NTFS file system first.
- The exFAT file system is not supported for SD cards and USB storage devices.
- Certain models do not support SD cards.

Photo & Video

- The photo feature is not supported in OLED models.

Supported Photo & Video Files

Supported External Subtitle Format

- *.smi, *.srt, *.sub (MicroDVD, SubViewer 1.0/2.0), *.ass, *.ssa, *.txt (TMPlayer), *.psb (PowerDivX), *.dcs (DLP Cinema)

! NOTE

- Subtitles are not supported in certain models.
- Embedded subtitles are not supported.

Supported Video Codecs

Extension	Codec	
.asf, .wmv	Video	VC-1 Advanced Profile (excluding WMVA), VC-1 Simple and Main Profiles
	Audio	WMA Standard (excluding WMA v1 / WMA Speech)
.avi	Video	Xvid (excluding 3 warp-point GMC), H.264/AVC, Motion Jpeg, MPEG-4
	Audio	MPEG-1 Layer I, II, MPEG-1 Layer III (MP3), Dolby Digital, LPCM, ADPCM, DTS
.mp4, .m4v, .mov	Video	H.264/AVC, MPEG-4, HEVC
	Audio	Dolby Digital, Dolby Digital Plus, AAC, MPEG-1 Layer III (MP3)
.3gp, .3g2	Video	H.264/AVC, MPEG-4
	Audio	AAC, AMR-NB, AMR-WB
.mkv	Video	MPEG-2, MPEG-4, H.264/AVC, VP8, VP9, HEVC
	Audio	Dolby Digital, Dolby Digital Plus, AAC, PCM, DTS, MPEG-1 Layer I, II, MPEG-1 Layer III (MP3)
.ts, .trp, .tp, .mts	Video	H.264/AVC, MPEG-2, HEVC
	Audio	MPEG-1 Layer I, II, MPEG-1 Layer III (MP3), Dolby Digital, Dolby Digital Plus, AAC, PCM
.mpg, .mpeg, .dat	Video	MPEG-1, MPEG-2
	Audio	MPEG-1 Layer I, II, MPEG-1 Layer III (MP3)
.vob	Video	MPEG-1, MPEG-2
	Audio	Dolby Digital, MPEG-1 Layer I, II, DVD-LPCM

! NOTE

- 3D videos are not supported.

Maximum data transfer rate

- Full HD video
H.264 1920 x 1080@60P BP/MP/HP@L4.2 40 Mbps
HEVC 1920 x 1080@60P MP@L4.1, Main10 Profile@L4.1 40 Mbps
- Ultra HD (For Ultra HD models only)
H.264 1920 x 1080@60P 4096 x 2160@30P BP/MP/HP@L5.1 50 Mbps
HEVC 4096 x 2160@60P MP@L5.1, Main10 Profile@L5.1 50 Mbps

Supported Photo File

File Format	Format	Item
.jpeg, .jpg, .jpe	JPEG	<ul style="list-style-type: none"> • Minimum: 64 x 64 • Maximum <ul style="list-style-type: none"> - Normal Type: 15360 (W) x 8640 (H) - Progressive Type: 1920 (W) x 1440 (H)
.png	PNG	<ul style="list-style-type: none"> • Minimum: 64 x 64 • Maximum: 5760 (W) x 5760 (H)
.bmp	BMP	<ul style="list-style-type: none"> • Minimum: 64 x 64 • Maximum: 1920 (W) x 1080 (H)

Viewing Photos and Videos

HOME /  → 

- 1 Select your desired storage device.
- 2 Select and view your desired photo or video.

Tips for Playing Video Files

- Some user-created subtitles may not work properly.
- Some special characters in subtitles are not rendered.
- HTML tags are not supported in subtitles.
- Subtitles in languages other than the supported languages are not available.
- The screen may suffer temporary interruptions (image stoppage, faster playback, etc.) when the audio language is changed.
- A damaged video file may not play correctly, or some player functions may not be usable.
- Video files produced with some encoders may not be played correctly.
- If the video and audio structure of a recorded file is not interleaved, either video or audio is outputted.
- Video files other than the specified types and formats may not play correctly.
- Maximum bit rate of playable video file is 20 Mbps. (Motion JPEG: 10 Mbps only)
- We cannot guarantee smooth playback of files encoded level 4.1 or higher in H.264 / AVC.
- Video files more than 30 GB in file size are not supported.
- A video file and its subtitle file must be located in the same folder. A video file name and its subtitle file name must be identical in order to display the subtitle properly.
- Playing a video via a USB connection that does not support high-speed connection may not function correctly.
- Subtitles on a Network Attached Storage (NAS) device may not be supported depending on the manufacturer and model.
- Streaming of files encoded by GMC (Global Motion Compensation) or Qpel (Quarterpel Motion Estimation) is not supported.
- (For Ultra HD models only) Ultra HD image: 3840 X 2160
Some HEVC-encoded Ultra HD videos other than the content officially provided by LG Electronics may not be played. Some codecs can be used after upgrading software.

Extension	Codec	
.mkv, .mp4, .ts	Video	H.264/AVC, HEVC
	Audio	Dolby Digital, Dolby Digital Plus, AAC, HE-AAC

- Playable file sizes may vary depending on the encoding condition.
- The AAC Main profile is not supported.
- Video files created by some encoders may not play.

Scheduled Playing

- Only applies to certain models.

You can schedule your selected content to play at a certain time. (Scheduled playing is available with external inputs.)

HOME /  → 

- 1 Select your desired storage device.
- 2 Enter the folder that contains the file you wish to schedule.
- 3 Click the New Scheduled Playing button in the upper right.
- 4 Select the content that you would like to schedule to play.
- 5 Enter schedule details to create a new schedule.
- 6 Watch your selected content play at the set time.

Export

- Only applies to certain models.

HOME /  → 

- 1 Select your desired storage device.
- 2 Enter the folder that contains the file you wish to export.
- 3 Click the Export button in the upper right.
- 4 Select the file you wish to export.
- 5 Click the Copy, Move button in the upper right and select the device to which you would like to export the file.
- 6 Check that the file has been copied or moved to the selected device.

Delete

HOME /  → 

- 1 Select your desired storage device.
- 2 Enter the path to the file you wish to delete.
- 3 Click the Delete button.
- 4 Select the file you wish to delete.
- 5 Click the Delete button at the top right.
- 6 Check that the file has been deleted from the list.

Music

Supported Music Files

- Some of the models that do not support the audio output cannot play the music.

File Format	Item	Information
.mp3	Bit rate	32 Kbps to 320 Kbps
	Sample freq.	16 KHz to 48 KHz
	Support	MPEG1, MPEG2
	Channels	Mono, Stereo
.wav	Bit rate	-
	Sample freq.	8 kHz to 48 kHz
	Support	PCM
	Channels	Mono, Stereo
.ogg	Bit rate	64 Kbps to 320 Kbps
	Sample freq.	8 kHz to 48 kHz
	Support	Vorbis
	Channels	Mono, Stereo
.wma	Bit rate	128 Kbps to 320 Kbps
	Sample freq.	8 kHz to 48 kHz
	Support	WMA
	Channels	Up to 6 channels

Playing Music

HOME /  → 

- 1 Select your desired storage device. You can select the songs you would like to play across all storage devices in My playlist.
- 2 Select the desired music content and enjoy.

Delete

HOME /  → 

- 1 Select your desired storage device.
- 2 Enter the path to the file you wish to delete.
- 3 Click the Delete button.
- 4 Select the file you wish to delete.
- 5 Click the Delete button at the top right.
- 6 Check that the file has been deleted from the list.

SuperSign Contents

Plays stored files using the Export option in SuperSign Editor.

To play back the stored files using the Export option

HOME /  → 

Only contents distributed by SuperSign Manager are displayed and selectable. If there is a USB/SD storage device connected, the image on the USB/SD device is outputted additionally.

NOTE

- If a folder named normal or AutoPlay exists on the USB/SD card and there are playable files, the files will play automatically when the USB/SD card is connected.
- OLED product types do not play content types other than single video or single flash files. Content produced via SuperSign Editor is not played either.

Information

To check the basic information of Signage Monitor

HOME /  → 

You can see the basic information on Signage Monitor.

You can also switch to Smart Energy Saving Mode or configure Fail Over settings. (You can switch to Smart Energy Saving Mode only when Energy Saving Mode is set to Off. The Smart Energy Saving mode is not available on OLED models.)



Local Contents Scheduler

- Only applies to certain models.
- The recommended resolution for scheduled photo playback is 4096 x 2160 or below.

Setting a Scheduled Playing

You can create a scheduled playing using the Local Contents Scheduler and the Photo & Video app.

Scheduled Playing with Photo & Video

- 1st Method: Refer to the scheduled playing section in Photo & Video app.
 - 2nd Method: **HOME** /  → 
- 1 Press the New Scheduled Playing button in the upper right.
 - 2 Press the Local Contents button.
 - 3 Select the storage device that you would like to schedule to play.
 - 4 Select the content that you would like to schedule to play after navigating to the Photo & Video app.
 - 5 Enter schedule details to create a new schedule.
 - 6 Watch your selected content play at the set time.

Scheduled Playing with External Input

HOME /  → 

- 1 Press the new scheduled playing button in the upper right.
- 2 Select the Input Source.
- 3 Enter schedule details to create a new schedule.
- 4 Watch your selected external input play at the set time.

Screen Share

- Only applies to certain models.

Allows the screens of devices such as a mobile device or Windows PC to be displayed on the monitor via wireless connections such as WiDi or Miracast.

Using Screen Share

HOME /  → 

- 1 Connect according to the instructions provided by the guide that can be accessed through the Connection Guide button in the upper right.
- 2 Once the connection is established, Screen Share between the user device and the monitor is enabled.

NOTE

Configuring WiDi (Wireless Display)

WiDi, which is short for Wireless Display, is a system that wirelessly transmits video and sound files from a laptop that supports Intel WiDi to the display.

This is available only in certain input modes (Composite/Component/RGB/HDMI/DP/OPS/DVI-D).

Other than these modes, LG Signage cannot be detected by your PC.

- 1 Connect your laptop to an AP. (This feature can be used without an AP, but it is recommended that you connect to it for optimal performance.) Run the Intel WiDi () program on your laptop.
- 2 Any nearby LG Signages supporting WiDi are detected. In the list of detected displays, select a Signage to connect to and then, click Connect. Enter the 8-digit PIN number (a) displayed on the Signage in the input field of your laptop (b) and click Continue.

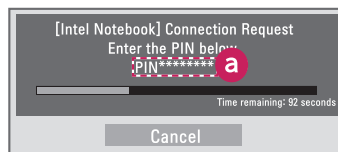

Signage screen

Laptop screen

- 3 The laptop screen appears in the Signage screen within 10 seconds. The wireless environment may affect the screen from displaying. If the connection is poor, the Intel WiDi connection may be lost.
- LG Signage does not need to be registered.
 - For more information on how to use Intel WiDi, visit <http://intel.com/go/widi>.
 - This works normally with WiDi 3.5 or later versions.

Group Manager

- Only applies to certain models.

Using this template-based content editing program, you can produce, manage and play content. There are three modes: Master, Slave and StandAlone. The program can be used to distribute and play schedules between the Master and Slave. It also provides access from mobile device or PC.

CAUTION

- A maximum of 5,000 images stored on a USB drive/SD card can be displayed from your PC or mobile device. Images more than 5,000 cannot be displayed from your PC or mobile device. In addition, we recommend you store no more than 1,000 images for use on your USB drive or SD card. If you use more than 1,000 images, the images may not be displayed smoothly depending on your environment.
- Supported devices (Some features may not be available depending on the type or version of your device or browser.)
 - Android 4.4 or later (Chromium v.38.0)
 - iOS 8 or later (Safari v.600.1.4 or later)
 - PC: Chromium v.38.0
- Supported resolutions (this program is optimized for the following resolutions):
 - 360 x 640, 600 x 960, 375 x 667, 768 x 1024 and 1920 x 1080
- If you play UHD videos on a UHD model, videos with a high bitrate may not play properly due to the limitations of the processing speed.
- You can select Slave mode in Master mode when the monitors are connected to the same network.
- Video files larger than 50 MB may not upload properly from mobile devices. We recommend that you play such files via USB/SD storage devices.

Function

The following functions are provided according to the mode selected by the user. However, Slave mode is automatically set to the monitor selected in Master mode.

- Master
 - Group: Add / Edit / Delete / Control (Volume, Backlight, Reboot, Exit)
 - Content: Add / Edit / Delete
 - Schedule: Add / Edit / Delete / Distribute / Play
 - Edit PIN Number / Automatic USB Backup / USB Backup Restoration / Mail Settings / QR Code / Device Mode
- Slave
 - Plays the schedule distributed by the Master
- StandAlone
 - Content: Add / Edit / Delete
 - Schedule: Add / Edit / Delete / Distribute / Play
 - Edit PIN Number / QR Code / Device Mode

How to Use

- Monitors: Run the app in the Launcher bar and add/edit/delete the desired content.
- Mobile devices: Run the app in the Launcher bar and get access using the QR code or URL provided.

! NOTE

- If you use a mobile device, you need to go through an authorization process using a PIN code. The default PIN code is '000000'.
- When using a PC, use the full screen (F11) feature in 1920 x 1080 (Full HD) resolution to view the same screen as the monitor.
- To delete a distributed schedule, disable the schedule and redistribute.

Supported Photo Files

File Format	Format	Item
.jpeg, .jpg	JPEG	<ul style="list-style-type: none"> • Minimum: 64 x 64 • Maximum: 1920 (W) x 1080 (H)
.png	PNG	<ul style="list-style-type: none"> • Minimum: 64 x 64 • Maximum: 1920 (W) x 1080 (H)

Supported Video Codecs

Refer to the 'Supported Video Codecs' table of Photo & Video app.

Tips for Playing Video Files

Refer to the 'Tips for Playing Video Files' subsection of Photo & Video app.

Leveler Tool

- Only applies to certain models.

You can check whether the product is horizontally and vertically level when installing the product outdoors in an enclosure.

Accessing the Leveler Tool

HOME /  → 

You can check whether the product is horizontally and vertically level.

Exiting the Leveler Tool

Exit the Leveler Tool by pressing the EXIT key on your remote control.

Checking the Angle of the Product

HOME /  → 

- You can check the tilt of the product using the bubble in the leveler and the angle indication.
- The left/right tilt is indicated by the leveler and angle indication on the left side of the screen.
- The front/back tilt is indicated by the leveler and angle indication on the right side of the screen.

NOTE

- If the product is tilted more than five degrees in any direction, an arrow will flash in the direction the product needs to be adjusted to.

Control Manager

- Only applies to certain models.

You can control and check the status of the display through web browser.

This function is available on PC and mobile device.

CAUTION

- Supported resolutions (this program is optimized for the following resolutions):
 - 1280 x 1024 / 375 x 667
- Supported browsers (this program is optimized for the following browsers):
 - IE 11 or later / Chrome 50 or later / Firefox 38 or later
- If set to OSD Portrait Mode, the OSD menu that appears on the captured screen will be in Landscape orientation.

Function

- Dashboard: Shows a summary of the product's status and provides links to each page.
- Device Control: Adjusts screen brightness, sound and input, reboots, etc.
- Virtual Controller: Shows the image displayed on the product in real time and enables remote control.
- Picture: Sets Picture Mode, Energy Saving, OSD Portrait, etc.
- Network: Sets Signage Name, IP Address, etc.
- Time: Enables or disables Set Automatically and shows the current time set for the product.
- Check Screen: Shows the product's current image output.
- Door Monitor: Shows whether the product is open or closed and provides controls for screen Mute for each status.
- S/W update: Provides firmware updates.
- Charts: Outputs information on the product's temperature, fan status, etc. in chart form.
- Fan Status: Shows the status of the fan installed in the product.
- Log: Displays product malfunction records.
- System Information: Outputs the product's S/W version, model name, etc.
- Media Library: Uploads media files to the product and outputs the uploaded file.

How to Use

On a PC

- 1 Enter '*https://Product IP address:3737*' in the browser's address bar to access the Control Manager login page.
- 2 Enter the password in the Password window (The default password is '000000').
- 3 Click the Login button after entering the password to access the Dashboard.
- 4 Click the face-shaped image to access the User Menu (Change Password, Logout).

On a Mobile Device (by entering IP address)

- 1 Enter '*https://Product IP address:3737*' in the browser's address bar to access the Control Manager login page.
- 2 Enter the password in the Password window (The default password is '000000').
- 3 Click the Login button after entering the password to access the Dashboard.
- 4 Click the Menu button in the upper left to expand the menu.
- 5 Click the face-shaped image to access the User Menu (Change Password, Logout).

On a Mobile Device (by QR code recognition)

- 1 Launch the Control Manager App.
- 2 Scan the QR Code with your smartphone to access the Login Page.
- 3 Click the Login button after entering the password to access the Dashboard.
- 4 Click the Menu button in the upper left to expand the menu.
- 5 Click the face-shaped image to access the User Menu (Change Password, Logout).

CAUTION

- For apps that do not support security protocols, access the Control Manager by entering the address displayed on the app's screen in your browser.

Follow the steps below if you encounter issues with your security certificate while attempting to access.

On Chrome

- 1 Click 'ADVANCED'

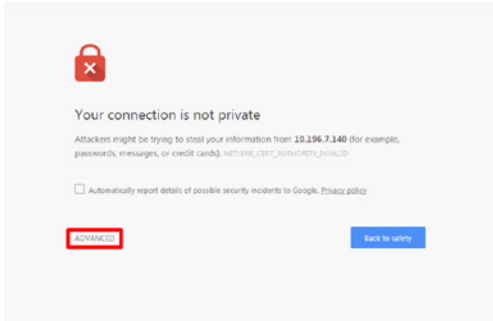

- 2 Click 'Proceed to product IP address (unsafe)'

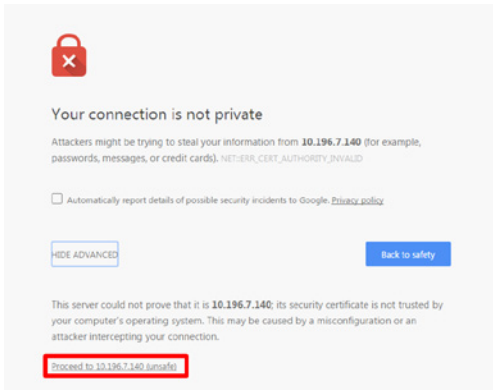

On FireFox

- 1 Click 'Advanced'

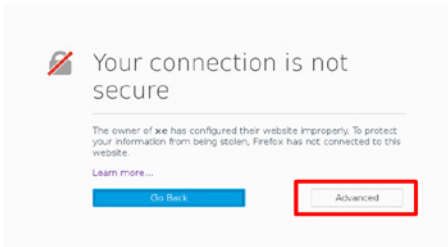

- 2 Click Add 'Exception...'

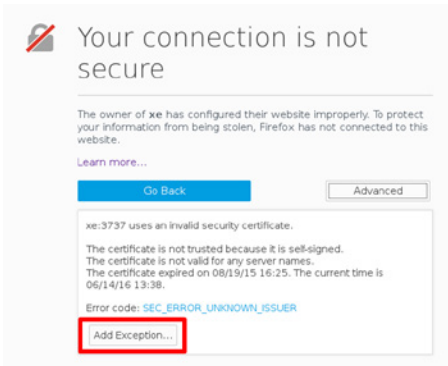

3 Click 'Confirm Security Exception'

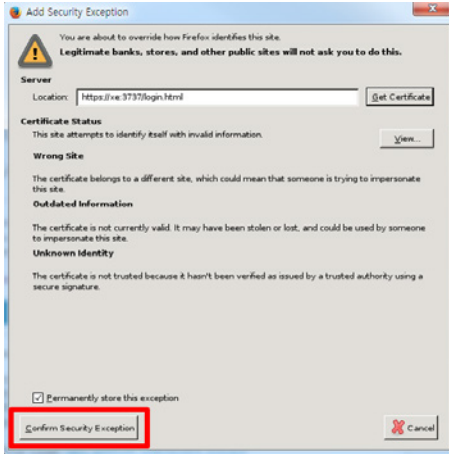

On Internet Explorer

1 Click 'Continue to this website (not recommended)'.

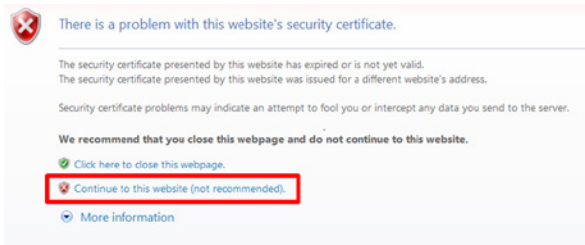

* The text of the links and buttons may differ depending on the OS (Operating System) or language settings used.

Multi-Screen

- Only applies to certain models. This feature allows you to view multiple external inputs and videos on a single screen.

Accessing Multi-Screen

HOME /  → 

Enter [Multi-screen] to select the screen layout.

! NOTE

- When entering [Multi-screen], the screen may flicker and the picture may appear abnormal on certain devices while the optimal resolution is selected automatically. If this happens, please restart the monitor.

Selecting Screen Layout

When you enter [Multi-screen] without having set any screen layout, the screen layout selection menu appears.

If the screen layout menu does not appear, you can press the up arrow key on the remote control to go to the screen layout menu bar and select it to show the screen layout menu.

Closing Screen Layout Menu

From the screen layout menu, press the up arrow key on the remote control to go to the screen layout menu bar and select it or press the 'BACK' key to close the screen layout menu.

Changing Screen Input

Press the  button on the top right of each split screen to select the desired input.

! NOTE

- Inputs which have already been selected for other split screens cannot be selected again. To select them, press the 'RESET' button to reset the inputs for all screens first.
- PIP mode is only available when Content Rotation and OSD Portrait are set to 0.

Playing Videos on Split Screens

Press the  button on the upper right of each split screen, select Video File, and then select a storage device to view the list of videos in the selected device. Next, select your desired video from the list to play it.

! NOTE

- Videos created with HEVC, MPEG-2, H.264, or VP9 codecs can be played on split screens. When using PIP mode, the following combinations cannot be used.

Main	Sub
HEVC	HEVC
H.264	HEVC
MPEG-2	HEVC
VP9	VP9

PICTURE ID Settings

- Only applies to certain models. [PICTURE ID] is used to change the settings of a specific set (display) using a single IR receiver for multi-vision. Communication is possible between a monitor with an IR receiver and other monitors using RS-232C cables. Each monitor is identified by a Set ID. If you assign the [PICTURE ID] using the remote control, only displays with matching PICTURE ID and Set ID can be controlled remotely.

- 1 Assign the Set ID to the installed monitors as shown below.

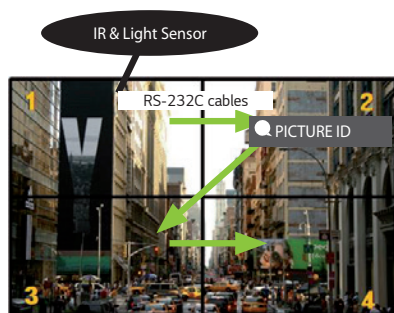

- 2 Press the red ON button on the remote control to assign the PICTURE ID.
- 3 Assign the Set ID to the selection of your choice.
 - A set with a different Set ID from the PICTURE ID cannot be controlled by IR signals.











! NOTE

- If PICTURE ID is set to 2, only the upper right monitor, which has a Set ID of 2, can be controlled by IR signals.
- If you press the green OFF button for PICTURE ID, the PICTURE ID for all monitors are turned off. If you then press any button on the remote control, all monitors can be controlled by IR signals regardless of Set ID.

IR CODES

All models do not support the HDMI/USB function.

Some key codes may not be supported depending on the model.

Code (Hex)	Function	Remarks
08	 (POWER)	Remote control button
C4	MONITOR ON	Remote control button
C5	MONITOR OFF	Remote control button
95	 (Energy Saving)	Remote control button
0B	 (INPUT)	Remote control button
10	Number Key 0	Remote control button
11	Number Key 1	Remote control button
12	Number Key 2	Remote control button
13	Number Key 3	Remote control button
14	Number Key 4	Remote control button
15	Number Key 5	Remote control button
16	Number Key 6	Remote control button
17	Number Key 7	Remote control button
18	Number Key 8	Remote control button
19	Number Key 9	Remote control button
02	 (Volume Up)	Remote control button
03	 (Volume Down)	Remote control button
E0	BRIGHTNESS  (Page Up)	Remote control button
E1	BRIGHTNESS  (Page Down)	Remote control button
DC	 (3D)	Remote control button
32	1/a/A	Remote control button
2F	CLEAR	Remote control button
7E	 SIMPLINK	Remote control button
79	ARC(MARK) (Aspect Ratio)	Remote control button
4D	PSM (Picture Mode)	Remote control button
09	 (MUTE)	Remote control button

Code (Hex)	Function	Remarks
43	⚙️ (SETTINGS (Menu))	Remote control button
99	Auto Config.	Remote control button
40	⤴️ (Up)	Remote control button
41	⤵️ (Down)	Remote control button
06	➤ (Right)	Remote control button
07	➤ (Left)	Remote control button
44	Ⓞ OK (OK)	Remote control button
28	↶ (BACK)	Remote control button
7B	TILE	Remote control button
5B	EXIT	Remote control button
72	PICTURE ID ON (RED)	Remote control button
71	PICTURE ID OFF (GREEN)	Remote control button
63	YELLOW	Remote control Button
61	BLUE	Remote control button
B1	■	Remote control button
B0	▶	Remote control button
BA		Remote control button
8F	◀◀	Remote control button
8E	▶▶	Remote control button
5F	W.BAL	Remote control button
3F	📺 (S.MENU)	Remote control button
7C	🏠 (HOME)	Remote control button
97	SWAP	Remote control button
96	MIRROR	Remote control button

TO CONTROL MULTIPLE PRODUCTS

- Only applies to certain models.

Use this method to connect several products to a single PC. You can control several products at a time by connecting them to a single PC.

In the Option menu, the Set ID must be between 1 and 1000 without being duplicated.

Connecting the Cable

- The image may be different according to the model.

Connect the RS-232C cable as shown in the picture.

The RS-232C protocol is used for communication between the PC and product. You can turn the product on or off, select an input source or adjust the OSD menu from your PC.

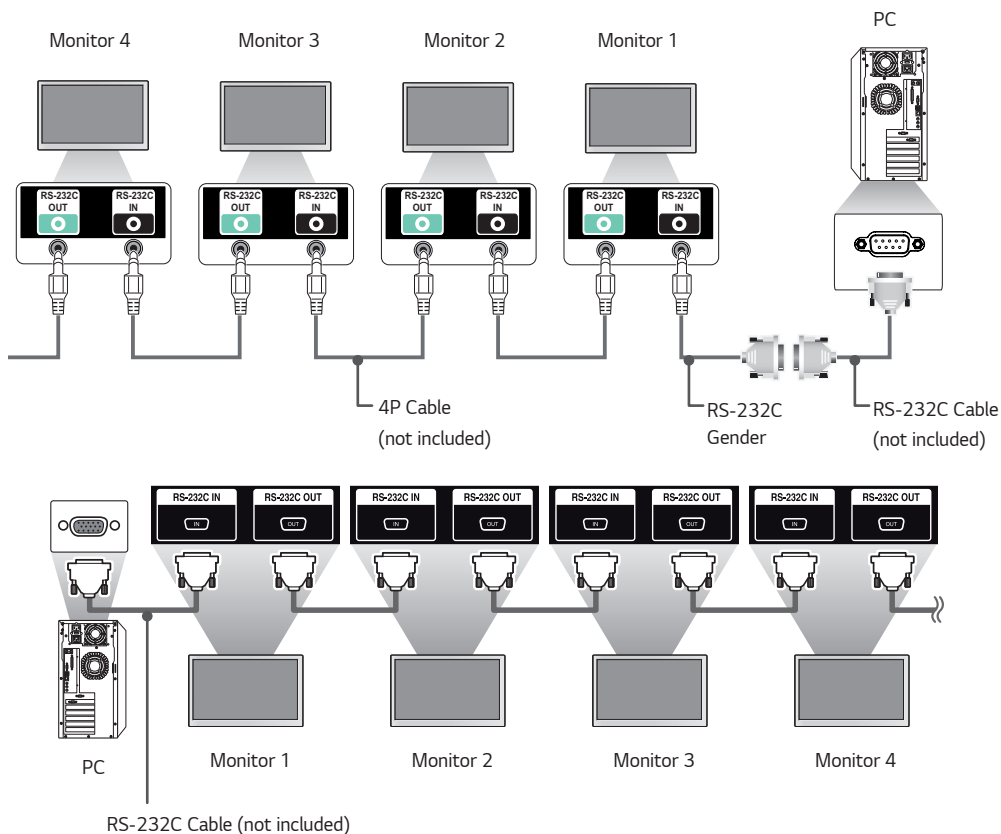

Communication Parameter

Baud Rate: 9600 bps
Data Length: 8 bit
Parity Bit: None
Stop Bit: 1 bit
Flow Control: None
Communication Code: ASCII code

! NOTE

- When using three-wire connections (non-standard), an IR daisy chain cannot be used.
- Be sure to only use the provided gender to connect properly.
- When monitors connected via Daisy Chain (that controls multiple monitors) are turned off and on successively, some monitors may not turn on. In this case, you can turn those MONITORS ON by pressing the **MONITOR ON** button, not the **POWER** button.

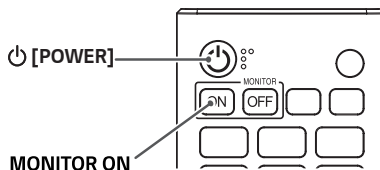

Command Reference List

		COMMAND		DATA (Hexadecimal)
		1	2	
01	[Power]	k	a	00 to 02
02	[Select input]	x	b	See [Select Input]
03	[Aspect Ratio]	k	c	See [Aspect Ratio]
04	[Energy Saving]	j	q	See [Energy Saving]
05	[Picture Mode]	d	x	See [Picture Mode]
06	[Contrast]	k	g	00 to 64
07	[Brightness]	k	h	00 to 64
08	[Sharpness]	k	k	00 to 32
09	[Color]	k	i	00 to 64
10	[Tint]	k	j	00 to 64
11	[Color temperature]	x	u	00 to 64
12	[Balance]	k	t	00 to 64
13	[Sound Mode]	d	y	See [Sound Mode]
14	[Mute]	k	e	00 to 01
15	[Volume Control]	k	f	00 to 64
16	[Time 1 (year/month/day)]	f	a	See [Time 1]
17	[Time 2 (hour/minute/second)]	f	x	See [Time 2]
18	[Off time schedule]	f	c	00 to 01
19	[On Time Schedule]	f	b	00 to 01
20	[Off Timer] ([Repeat]/[Time])	f	e	See [Off Timer]
21	[On Timer] ([Repeat]/[Time])	f	d	See [On Timer]
22	[On Timer Input]	f	u	See [On Timer Input]
23	[No Signal Power Off (15Min)]	f	g	00 to 01
24	[Auto Power Off (4 Hours)]	m	n	00 to 01
25	[Language]	f	i	See [Language]

		COMMAND		DATA (Hexadecimal)
		1	2	
26	[Reset]	f	k	00 to 02
27	[Current Temperature]	d	n	FF
28	[Key]	m	c	See [Key]
29	[Time Elapsed]	d	l	FF
30	[Product Serial Number]	f	y	FF
31	[Software Version]	f	z	FF
32	[White Balance Red Gain]	j	m	00 to FE
33	[White Balance Green Gain]	j	n	00 to FE
34	[White Balance Blue Gain]	j	o	00 to FE
35	[White Balance Red Offset]	s	x	00 to 7F
36	[White Balance Green Offset]	s	y	00 to 7F
37	[White Balance Blue Offset]	s	z	00 to 7F
38	[Backlight]	m	g	00 to 64
39	[Screen off]	k	d	00 to 01
40	[Tile Mode]	d	d	00 to FF
41	[Check Tile Mode]	d	z	FF
42	[Tile ID]	d	i	See [Tile ID]
43	[Natural Mode]	d	j	00 to 01
44	[DPM Select]	f	j	00 to 07
45	[Remote Control]/[Local Key Lock]	k	m	00 to 01
46	[Power On Delay]	f	h	00 to FA
47	[Fail Over Select]	m	i	00 to 02
48	[Fail Over Input Select]	m	j	See [Fail Over Input Select]
49	[IR Operation]	t	p	00 to 02
50	[Local Key Operation]	t	o	00 to 02

		COMMAND		DATA (Hexadecimal)
		1	2	
51	[Check the status]	s	v	See [Check the status]
52	[Check Screen]	t	z	00 to 01
53	[Speakers]	d	v	00 to 01
54	[Daylight Saving Time]	s	d	See [Daylight Saving Time]
55	[PM Mode]	s	n, 0c	00 to 03
56	[ISM Method]	j	p	See [ISM Method]
57	[Network Settings]	s	n, 80(81)(82)	See [Network Settings]
58	[Auto-adjustment]	j	u	01
59	[H Position]	f	q	00 to 64
60	[V Position]	f	r	00 to 64
61	[H Size]	f	s	00 to 64
62	[Power On Status]	t	r	00 to 02
63	[Wake On LAN]	f	w	00 to 01
64	[Intelligent Auto]	t	i	00 to 01
65	[OSD Portrait Mode]	t	h	00 to 02
66	[Reset to Initial Settings]	t	n	00 to 01
67	[Time Sync]	s	n, 16	00 to 01
68	[Contents Sync]	t	g	00 to 01
69	[Pivot Mode]	t	a	00 to 01
70	[Studio Mode]	s	n, 83	00 to 01
71	[LAN Daisy Chain]	s	n, 84	00 to 01
72	[Content Rotation]	s	n, 85	00 to 02
73	[DPM Wake up Control]	s	n, 0b	00 to 01
74	[Scan Inversion]	s	n, 87	00 to 01
75	[Beacon]	s	n, 88	00 to 01

		COMMAND		DATA (Hexadecimal)
		1	2	
76	[Aspect Ratio] ([Rotation])	s	n, 89	00 to 01
77	[Easy Brightness Control Mode]	s	m	00 to 01
78	[Easy Brightness Control Schedule]	s	s	See [Easy Brightness Control Schedule]
79	[MultiScreen] Mode & [Input]	x	c	See [MultiScreen] Mode & [Input]
80	[Aspect Ratio] ([MultiScreen])	x	d	See [Aspect Ratio] ([MultiScreen])
81	[Screen Mute] ([MultiScreen])	x	e	See [Screen Mute] ([MultiScreen])
82	[Screen Off Always]	s	n, 0d	00 to 01
83	[Screen Video Freeze]	k	x	00 to 01
84	[Wireless Wake On LAN]	s	n, 90	00 to 01
85	[JustScan Toggle]	s	n, 91	00 to 01
86	[Holiday Schedule Mode]	s	n, 1a	00 to 01
87	[Holiday Schedule]	s	n, 1b	See [Holiday Schedule section]
88	[Dual Screen Off]	s	n, 92	00 to 02
89	[Fan Control]	d	o	00 to 03
90	[Fan Failure Check]	d	w	FF
91	[Luminance Value Read]	m	u	FF
92	[BLU Maintenance]	m	t	00 to 01
93	[Power Indicator Settings]	f	o	00 to 01
94	[OSD Display]	k	l	00 to 01
95	[Semi-Transparent Brightness]	s	n, 95	00 to 64
96	[Hybrid Mode]	s	n, 96	00 to 02
97	[Return Interval]	s	n, 97	00 to 0a
98	[Proximity Sensitivity]	s	n, 98	00 to 02
99	[HDMI IT Contents]	s	n, 99	00 to 01
100	[UPnP Mode]	s	n, 9c	00 to 01
101	[Model Name check]	f	v	FF
102	[No Signal Image]	s	n, a9	00 to 01
103	Wi-Fi	s	n, 9f	00 to 01
104	Analog Signage BLU Setting	s	n, c2	00 to 01
105	Analog Signage BLU On/Off Time Setting	s	n, c3	See Analog Signage BLU On/Off Time Setting
106	BLU Manual On/Off	s	n, c4	00 to 01
107	Silent fan mode	s	n, c7	00 to 01

* Note: Commands may not work when the external input is not used. Some commands may not be supported depending on the model.

Transmission/Reception Protocol

Transmission

[Command1][Command2][][Set ID][][Data][Cr]

- * [Command1]: Identifies between the factory setting and the user setting modes.
- * [Command2]: Controls monitor sets.
- * [Set ID]: Used for selecting a set you want to control. A unique Set ID can be assigned to each set ranging from 1 to 1000(01H-3E8H) under Settings in the OSD menu. Selecting '00H' for Set ID allows the simultaneous control of all connected monitors. (The maximum value may differ depending on the model.)
- * [Data]: Transmits command data. Data count may increase depending on the command.
- * [Cr]: Carriage Return. Corresponds to '0x0D' in ASCII code.
- * []: White Space. Corresponds to '0x20' in ASCII code.

Acknowledgement

[Command2][][Set ID][][OK/NG][Data][x]

- * The Product transmits ACK (acknowledgement) based on this format when receiving normal data. At this time, if the data is FF, it indicates the present status data. If the data is in data write mode, it returns the data of the PC computer.
- * If a command is sent with Set ID '00' (=0x00), the data is reflected to all monitor sets and each monitor set does not send an acknowledgement (ACK).
- * If the data value 'FF' is sent in control mode via RS-232C, the current setting value of a function can be checked (only for some functions).
- * Some commands are not supported depending on the model.

01. [Power] (Command: k a)

Controls the power on/off of the set.

Transmission**(k)(a)()(Set ID)()(Data)(Cr)**

Data 00: Off
01: On
02: Restart

Acknowledgement**(a)()(Set ID)()(OK/NG)(Data)(x)**

- * The acknowledgement signal is returned properly only when the monitor is fully powered on.
- * There may be a delay between the transmission and acknowledgement signals.

02. [Select Input] (Command: x b)

Selects an input signal.

Transmission**(x)(b)()(Set ID)()(Data)(Cr)**

Data 20: AV
40: COMPONENT
60: RGB
70: DVI-D (PC)
80: DVI-D (DTV)
90: HDMI1 (DTV)
A0: HDMI1 (PC)
91: HDMI2/OPS (DTV)
A1: HDMI2/OPS (PC)
92: OPS/HDMI3/DVI-D (DTV)
A2: OPS/HDMI3/DVI-D (PC)
95: OPS/DVI-D (DTV)
A5: OPS/DVI-D (PC)
96: HDMI3/DVI-D (DTV)
A6: HDMI3/DVI-D (PC)
98: OPS (DTV)
A8: OPS (PC)
C0: DISPLAYPORT (DTV)
D0: DISPLAYPORT (PC)
E0: SuperSign webOS Player
E1: Others
E2: Multi Screen

Acknowledgement**(b)()(Set ID)()(OK/NG)(Data)(x)**

- * Some input signals may not be supported depending on the model.
- * Returns to NG if the webOS Player is not distributed from SuperSign W or SuperSign Premium.

03. [Aspect Ratio] (Command: k c)

Adjusts the aspect ratio.

Transmission**(k)(c)()(Set ID)()(Data)(Cr)**

Data 01: 4:3
02: 16:9
04: Zoom
06: Set by Program
09: Just Scan (720p or higher)
10-1F: Cinema Zoom 1 to 16
21: 58:9
30: Vertical Zoom
31: All-Direction Zoom

- * Available data types differ depending on the input signal. For more information, see the aspect ratio section of the owner's manual.
- * The aspect ratio may differ depending on the model's input configuration.

Acknowledgement**(c)()(Set ID)()(OK/NG)(Data)(x)****04. [Energy Saving] (Command: j q)**

Sets the Energy Saving.

Transmission**(j)(q)()(Set ID)()(Data)(Cr)**

Data 00: Off
01: Minimum
02: Medium
03: Maximum
04: Automatic
05: Screen off

Acknowledgement**(q)()(Set ID)()(OK/NG)(Data)(x)**

- * This may not be supported depending on the model.

05. [Picture Mode] (Command: d x)

Selects a picture mode.

Transmission**(d)(x)() (Set ID)() (Data)(Cr)**

Data 00: Vivid
 01: Standard
 02: Cinema
 03: Sports
 04: Game
 05: Expert 1
 06: Expert 2
 08: APS
 09: Photos
 10: Touch
 11: Calibration

Acknowledgement**(x)() (Set ID)() (OK/NG)(Data)(x)**

* Depending on the model, some picture modes may not be supported.

06. [Contrast] (Command: k g)

Adjusts the screen contrast.

Transmission**(k)(g)() (Set ID)() (Data)(Cr)**

Data 00-64: Contrast 0 to 100

Acknowledgement**(g)() (Set ID)() (OK/NG)(Data)(x)****07. [Brightness] (Command: k h)**

Adjusts the screen brightness.

Transmission**(k)(h)() (Set ID)() (Data)(Cr)**

Data 00-64: Brightness 0 to 100

Acknowledgement**(h)() (Set ID)() (OK/NG)(Data)(x)****08. [Sharpness] (Command: k k)**

Adjusts the screen sharpness.

Transmission**(k)(k)() (Set ID)() (Data)(Cr)**

Data 00-32: Sharpness 0 to 50

Acknowledgement**(k)() (Set ID)() (OK/NG)(Data)(x)****09. [Color] (Command: k i)**

Adjusts the screen color.

Transmission**(k)(i)() (Set ID)() (Data)(Cr)**

Data 00-64: Color 0 to 100

Acknowledgement**(i)() (Set ID)() (OK/NG)(Data)(x)****10. [Tint] (Command: k j)**

Adjusts the screen tint.

Transmission**(k)(j)() (Set ID)() (Data)(Cr)**

Data 00-64: Tint red 50 to green 50

Acknowledgement**(j)() (Set ID)() (OK/NG)(Data)(x)****11. [Color Temperature] (Command: x u)**

Adjusts the screen color temperature.

Transmission**(x)(u)() (Set ID)() (Data)(Cr)**

Data 00-64: warm 50 to cool 50

Acknowledgement**(u)() (Set ID)() (OK/NG)(Data)(x)**

12. [Balance] (Command: k t)

Adjusts the sound balance.

Transmission**(k)(t)() (Set ID)() (Data)(Cr)**

Data 00-64: Left 50 to right 50

Acknowledgement**(t)() (Set ID)() (OK/NG)(Data)(x)**

* It may not be supported depending on the model.

13. [Sound mode] (Command: d y)

Selects a sound mode.

Transmission**(d)(y)() (Set ID)() (Data)(Cr)**Data 01: Standard
02: Music
03: Cinema
04: Sports
05: Game
07: News (Clear Voice III)**Acknowledgement****(y)() (Set ID)() (OK/NG)(Data)(x)**

* It may not be supported depending on the model.

14. [Mute] (Command: k e)

Mutes/unmutes the sound.

Transmission**(k)(e)() (Set ID)() (Data)(Cr)**Data 00: Mute
01: Unmute**Acknowledgement****(e)() (Set ID)() (OK/NG)(Data)(x)**

* It may not be supported depending on the model.

15. [Volume Control] (Command: k f)

Adjusts the playback volume.

Transmission**(k)(f)() (Set ID)() (Data)(Cr)**

Data 00-64: Volume 0 to 100

Acknowledgement**(f)() (Set ID)() (OK/NG)(Data)(x)**

* It may not be supported depending on the model.

16. [Time] 1 (year/month/day) (Command: f a)

Sets the values of the Time 1 (year/month/day), or sets the Auto time.

Transmission1. **(f)(a)() (Set ID)() (Data1)() (Data2)() (Data3)(Cr)**2. **(f)(a)() (Set ID)() (0)(0)() (Data1)() (Cr)**

1. Setting the Time 1 (year/month/day)

Data1 04-1B: year 2014 to 2037

Data2 01-0C: January to December

Data3 01-1F: 1st to 31st

* Enter "fa [Set ID] ff" to view the Time 1 (year/month/day) settings.

2. Setting the Auto time

Data1 00: Auto

01: Manual

* To view the set value of the Auto time, enter "fa [Set ID] 00 ff".

Acknowledgement1. **(a)() (Set ID)() (OK/NG)(Data1)(Data2)(Data3)(x)**2. **(a)() (Set ID)() (OK/NG)(0)(0)(Data1)(x)**

17. [Time] 2 (hour/minute/second) (Command: f x)

Adjusts the Time 2 (hour/minute/second) value.

Transmission

(f)(x)()(Set ID)()(Data1)()(Data2)()(Data3)(Cr)

Data1 00-17:00 to 23 hours
 Data2 00-3B:00 to 59 minutes
 Data3 00-3B:00 to 59 seconds

* Enter "fx [Set ID] ff" to view the Time 2 (hour/minute/second) settings.

* This function is only available when Time 1 (year/month/day) is set.

Acknowledgement

(x)()(Set ID)()(OK/NG)(Data1)(Data2)(Data3)(x)

18. [Off Time Schedule] (Command: f c)

Enables/disables the Off Time Schedule.

Transmission

(f)(c)()(Set ID)()(Data)(Cr)

Data 00: Off
 01: On

Acknowledgement

(c)()(Set ID)()(OK/NG)(Data)(x)

19. [On Time Schedule] (Command: f b)

Enables/disables the On Time schedule.

Transmission

(f)(b)()(Set ID)()(Data)(Cr)

Data 00: Off
 01: On

Acknowledgement

(b)()(Set ID)()(OK/NG)(Data)(x)

20. [Off Timer] (Repeat/Time) (Command: f e)

Configures Off Timer (Repeat/Time) settings.

Transmission

(f)(e)()(Set ID)()(Data1)()(Data2)()(Data3)(Cr)

Data1
 1. f1h-f7h (reading data)
 F1: Reads the 1st Off Timer data
 F2: Reads the 2nd Off Timer data
 F3: Reads the 3rd Off Timer data
 F4: Reads the 4th Off Timer data
 F5: Reads the 5th Off Timer data
 F6: Reads the 6th Off Timer data
 F7: Reads the 7th Off Timer data

2. e1h-e7h (delete one index), e0h (delete all indexes)

E0: Erases all Off Timer settings
 E1: Erases the 1st Off Timer setting
 E2: Erases the 2nd Off Timer setting
 E3: Erases the 3rd Off Timer setting
 E4: Erases the 4th Off Timer setting
 E5: Erases the 5th Off Timer setting
 E6: Erases the 6th Off Timer setting
 E7: Erases the 7th Off Timer setting

3. 01h-0Ch (sets the day of the week for the Off Timer)

01: Once
 02: Daily
 03: Mon - Fri
 04: Mon - Sat
 05: Sat - Sun
 06: Every Sunday
 07: Every Monday
 08: Every Tuesday
 09: Every Wednesday
 0A: Every Thursday
 0B: Every Friday
 0C: Every Saturday

Data2 00-17:00 to 23 hours

Data3 00-3B:00 to 59 minutes

* To read or delete the Off Time Schedule list, [Data2][Data3] must be set to FFH.

Example 1: fe 01 f1 ff ff - reads the first index data in Off Timer.

Example 2: fe 01 e1 ff ff - deletes the first index data from Off Timer.

Example 3: fe 01 04 02 03 - sets Off Timer to 02:03 from Monday to Saturday.

* This function is only available when Time 1 (year/month/day) and Time 2 (hour/minute/second) are set.

Acknowledgement

(e)()(Set ID)()(OK/NG)(Data1)(Data2)(Data3)(x)

21. [On timer](Repeat/Time) (Command: f d)

Configures On Timer (Repeat/Time) settings.

Transmission

(f)(d)()(Set ID)()(Data1)()(Data2)()(Data3)(Cr)

Data1

1. f1h-f7h (reading data)

F1: Reads the 1st On Timer data

F2: Reads the 2nd On Timer data

F3: Reads the 3rd On Timer data

F4: Reads the 4th On Timer data

F5: Reads the 5th On Timer data

F6: Reads the 6th On Timer data

F7: Reads the 7th On Timer data

2. e1h-e7h (delete one index), e0h (delete all indexes)

E0: Erases all On Timer settings

E1: Erases the 1st On Timer setting

E2: Erases the 2nd On Timer setting

E3: Erases the 3rd On Timer setting

E4: Erases the 4th On Timer setting

E5: Erases the 5th On Timer setting

E6: Erases the 6th On Timer setting

E7: Erases the 7th On Timer setting

3. 01h-0Ch (sets the day of the week for the On Timer)

01: Once

02: Daily

03: Mon - Fri

04: Mon - Sat

05: Sat - Sun

06: Every Sunday

07: Every Monday

08: Every Tuesday

09: Every Wednesday

0A: Every Thursday

0B: Every Friday

0C: Every Saturday

Data2 00-17:00 to 23 hours

Data3 00-3B:00 to 59 minutes

* To read or delete an On Time schedule list, [Data2][Data3] must be set to FF.

Example 1: fd 01 f1 ff ff - reads the first index data from On Timer.

Example 2: fd 01 e1 ff ff - deletes the first index data from On Timer.

Example 3: fd 01 04 02 03 - sets On Timer to 02:03 from Monday to Saturday.

* This function is only available when Time 1 (year/month/day) and Time 2 (hour/minute/second) are set.

* This feature functions normally only after 22. On Timer Input has been entered.

Acknowledgement

(d)()(Set ID)()(OK/NG)(Data1)(Data2)(Data3)(x)

22. [On Timer Input] (Command: f u)

Select an external input for the current On Time setting and add a new schedule.

Transmission

(f)(u)()(Set ID)()(Data1)(Cr)

(f)(u)()(Set ID)()(Data1)()(Data2)(Cr)

Data (adding schedule)

40: COMPONENT

60: RGB

70: DVI-D

A0: HDMI1

A1: HDMI2/OPS

A2: OPS/HDMI3/DVI-D

A5: OPS/DVI-D

A6: HDMI3/DVI-D

A8: OPS

D0: DISPLAYPORT

Data1 (Read schedule)

1. f1h-f7h (Read data)

F1: Select the 1st schedule input

F2: Select the 2nd schedule input

F3: Select the 3rd schedule input

F4: Select the 4th schedule input

F5: Select the 5th schedule input

F6: Select the 6th schedule input

F7: Select the 7th schedule input

Data2 (Read schedule)

FF

* To read the schedule input, enter FF for [Data2].

If no schedule is available for [Data1] when attempting to read the schedule data, the text 'NG' will be displayed and the operation will fail.

Example 1: fu 01 90 - Move each schedule input down one row and save the 1st schedule input in HDMI mode.

Example 2: fu 01 f1 ff - Read the 1st schedule input.

* This function is only supported when 1 (year/month/date), 2 (hour/minute/second) and On Time (repeat mode/time) are set.

* This feature operates as the last input.

* Input is possible in PC or DTV format during transmission and output is in PC format for acknowledgment.

(e.g. For HDMI1, both 0x90 and 0xA can be input, while 0xA0 is printed for acknowledgment.)

* This may not be supported on some models.

Acknowledgement

(u)()(Set ID)()(OK/NG)(Data)(x)

(u)()(Set ID)()(OK/NG)(Data1)(Data2)(x)

23. [No Signal Power Off] (15Min) (Command: f g)

Sets the monitor to enter Automatic Standby mode if there is no signal for 15 minutes.

Transmission

(f)(g)()(Set ID)()(Data)(Cr)

Data 00: Off
01: On

Acknowledgement

(g)()(Set ID)()(OK/NG)(Data)(x)

24. [Auto Power Off] (4 Hours) (Command: m n)

Sets the monitor to enter Auto Power Off after 4 hours.

Transmission

(m)(n)()(Set ID)()(Data)(Cr)

Data 00: Off
01: 4 hours

Acknowledgement

(n)()(Set ID)()(OK/NG)(Data)(x)

25. [Language] (Command: f i)

Sets the OSD language.

Transmission

(f)(i)()(Set ID)()(Data)(Cr)

Data 00: Czech
01: Danish
02: German
03: English
04: Spanish (Europe)
05: Greek
06: French
07: Italian
08: Dutch
09: Norwegian
0A: Portuguese
0B: Portuguese (Brazil)
0C: Russian
0D: Finnish
0E: Swedish
0F: Korean
10: Chinese (Mandarin)
11: Japanese
12: Chinese (Cantonese)
13: Arabic

Acknowledgement

(i)()(Set ID)()(OK/NG)(Data)(x)

26. [Reset] (Command: f k)

Performs the reset function.

Screen Reset can only be performed in RGB input mode.

Transmission

(f)(k)()(Set ID)()(Data)(Cr)

Data 00: Picture Reset
01: Screen reset
02: Initial Settings

Acknowledgement

(k)()(Set ID)()(OK/NG)(Data)(x)

* It may not be supported depending on the model.

27. [Current temperature] (Command: d n)

Checks the inside temperature.

Transmission

(d)(n)()(Set ID)()(Data)(Cr)

Data FF: Check the status

Acknowledgement

(n)()(Set ID)()(OK/NG)(Data)(x)

* Temperature is displayed as a hexadecimal value.

28. [Key] (Command: m c)

Sends a key code for the IR remote control.

Transmission

(m)(c)()(Set ID)()(Data)(Cr)

Data IR_KEY_CODE

Acknowledgement

(c)()(Set ID)()(OK/NG)(Data)(x)

* For key codes, see IR Codes.

* Some key codes are not supported depending on the model.

29. [Time Elapsed] (Command: d l)

Checks the elapsed time.

Transmission`(d)(l)()(Set ID)()(Data)(Cr)`

Data FF: Read status

Acknowledgement`(l)()(Set ID)()(OK/NG)(Data)(x)`

* The data received is shown as a hexadecimal value.

33. [White Balance Green Gain] (Command: j n)

Adjusts the white balance green gain value.

Transmission`(j)(n)()(Set ID)()(Data)(Cr)`

Data 00-FE: Green Gain 0 to 254

FF: Checks the green gain value

Acknowledgement`(n)()(Set ID)()(OK/NG)(Data)(x)`**30. [Product serial number] (Command: f y)**

Checks the serial number of the product.

Transmission`(f)(y)()(Set ID)()(Data)(Cr)`

Data FF: Check product serial number

Acknowledgement`(y)()(Set ID)()(OK/NG)(Data)(x)`

* Data is in ASCII code.

34. [White Balance Blue Gain] (Command: j o)

Adjusts the white balance blue gain value.

Transmission`(j)(o)()(Set ID)()(Data)(Cr)`

Data 00-FE: Blue Gain 0 to 254

FF: Checks the blue gain value

Acknowledgement`(o)()(Set ID)()(OK/NG)(Data)(x)`**31. [Software Version] (Command: f z)**

Checks the software version of the product.

Transmission`(f)(z)()(Set ID)()(Data)(Cr)`

Data FF: Check software version

Acknowledgement`(z)()(Set ID)()(OK/NG)(Data)(x)`**35. [White Balance Red Offset] (Command: s x)**

Adjusts the white balance red offset value.

Transmission`(s)(x)()(Set ID)()(Data)(Cr)`

Data 00-7F: Red Offset 0 to 127

FF: Checks the red offset value

Acknowledgement`(x)()(Set ID)()(OK/NG)(Data)(x)`**32. [White balance red gain] (Command: j m)**

Adjusts the white balance red gain value.

Transmission`(j)(m)()(Set ID)()(Data)(Cr)`

Data 00-FE: Red Gain 0 to 254

FF: Checks the red gain value

Acknowledgement`(m)()(Set ID)()(OK/NG)(Data)(x)`**36. [White Balance Green Offset] (Command: s y)**

Adjusts the white balance green offset value.

Transmission`(s)(y)()(Set ID)()(Data)(Cr)`

Data 00-7F: Green Offset 0 to 127

FF: Checks the green offset value

Acknowledgement`(y)()(Set ID)()(OK/NG)(Data)(x)`

37. [White Balance Blue Offset] (Command: s z)

Adjusts the white balance blue offset value.

Transmission

(s)(z)()(Set ID)()(Data)(Cr)

Data 00-7F: Blue Offset 0 to 127
FF: Checks the blue offset value

Acknowledgement

(z)()(Set ID)()(OK/NG)(Data)(x)

38. [Backlight] (Command: m g)

Adjusts the backlight brightness.

Transmission

(m)(g)()(Set ID)()(Data)(Cr)

Data 00-64: Backlight 0 to 100

Acknowledgement

(g)()(set ID)()(OK/NG)(Data)(x)

39. [Screen Off] (Command: k d)

Turns the screen on or off.

Transmission

(k)(d)()(Set ID)()(Data)(Cr)

Data 00: Turns the screen on
01: Turns the screen off

Acknowledgement

(d)()(Set ID)()(OK/NG)(Data)(x)

* This may not be supported on some models.

* Dual-screen models must use the screen off commands in 88. Dual Screen Off.

40. [Tile Mode] (Command: d d)

Sets the Tile Mode and sets values for the tile rows and columns.

Transmission

(d)(d)()(Set ID)()(Data)(Cr)

Data 00-FF: The first byte - Tile column
The second byte - Tile row

* 00, 01, 10, and 11 mean that the tile mode is off

* The maximum value may differ depending on the model.

Acknowledgement

(d)()(Set ID)()(OK/NG)(Data)(x)

* It may not be supported depending on the model.

41. [Check Tile Mode] (Command: d z)

Checks the tile mode.

Transmission

(d)(z)()(Set ID)()(Data)(Cr)

Data FF: Checks the tile mode

Acknowledgement

(z)()(Set ID)()(OK/NG)(Data1)(Data2)(Data3)(x)

Data1 00: Off (Tile mode off)
01: On (Tile mode on)

Data2 00-0F: Tile column

Data3 00-0F: Tile row

* It may not be supported depending on the model.

42. [Tile ID] (Command: d i)

Sets the tile ID value of the product.

Transmission

(d)(i)()(Set ID)()(Data)(Cr)

Data 01-E1: Tile ID 1 to 225**
FF: Checks the tile ID

* The data value cannot exceed the value of row x column.

Acknowledgement

(i)()(Set ID)()(OK/NG)(Data)(x)

* When a data value that exceeds the value of row x column is entered (except 0xFF), ACK becomes NG.

* It may not be supported depending on the model.

43. [Natural Mode] (in Tile mode) (Command: d j)

When displaying the image naturally, the part of the image that would normally be displayed in the gap between the monitors is omitted.

Transmission

(d)(j)() (Set ID)() (Data)(Cr)

Data 00: Off
01: On

Acknowledgement

(j)() (Set ID)() (OK/NG)(Data)(x)

* It may not be supported depending on the model.

46. [Power On Delay] (Command: f h)

Sets the schedule delay when the power turns on. (unit: seconds).

Transmission

(f)(h)() (Set ID)() (Data)(Cr)

Data 00-FA: min. 0 to maximum 250 (seconds)

* The maximum value may differ depending on the model.

Acknowledgement

(h)() (Set ID)() (OK/NG)(Data)(x)

47. [Fail Over Select] (Command: m i)

Selects an input mode for auto switch.

Transmission

(m)(i)() (Set ID)() (Data)(Cr)

Data 00: Off
01: Auto
02: Manual

Acknowledgement

(i)() (Set ID)() (OK/NG)(Data)(x)

44. [DPM Select] (Command: f j)

To set the DPM (Display Power Management) function.

Transmission

(f)(j)() (Set ID)() (Data)(Cr)

Data 00: Off
01: 5 seconds
02: 10 seconds
03: 15 seconds
04: 1 minutes
05: 3 minutes
06: 5 minutes
07: 10 minutes

Acknowledgement

(j)() (Set ID)() (OK/NG)(Data)(x)

45. [Remote Control] / [Local Key Lock] (Command: k m)

Adjusts the remote control/local key (front) lock.

Transmission

(k)(m)() (Set ID)() (Data)(Cr)

Data 00: Off (Lock Off)
01: On (Lock On)

* When the monitor is turned off, the power key works even in On (01) mode.

Acknowledgement

(m)() (Set ID)() (OK/NG)(Data)(x)

48. [Fail Over Input Select] (Command: m j)

Selects an input source for auto switch.

- * This command is only available when the Fail Over (auto) mode is set to Custom.

Transmission

(m)(j)() (Set ID)() (Data1)() (Data2)() (Data3)() (Data4)...() (DataN)(Cr)

Data 1~N-1 (Input priority: 1~N-1)

40: COMPONENT
60: RGB
70: DVI-D
90: HDMI1
91: HDMI2/OPS
92: OPS/HDMI3/DVI-D
95: OPS/DVI-D
96: HDMI3/DVI-D
98: OPS
C0: DISPLAYPORT

Data N: E0: INTERNAL Memory
E1: USB
E2: SD CARD

Acknowledgement

(j)() (SetID)() (OK/NG)(Data1)(Data2)(Data3)(Data4)...(DataN)(x)

- * Some input signals may not be supported on some models.
- * The data number (N) may vary depending on the model. (The data number depends on the number of supported input signals.)
- * Only values under Data N (e.g. E0, E1, E2) are allowed as the last data value and may not be supported depending on the model.
- * This feature operates as the last input and supports data in DTV format.

49. [IR Operation] (Command: t p)

Configures the IR operation settings of the product.

Transmission

(t)(p)() (Set ID)() (Data)(Cr)

Data 00: Locks off all of the keys
01: Locks on all of the keys except the Power key
02: Locks on all of the keys

Acknowledgement

(x)() (Set ID)() (OK/NG)(Data)(x)

- * When the monitor is turned off, the power key works even in the locks on all of the keys (02) mode.

50. [Local Key Operation] (Command: t o)

Configures the local key operation settings of the product.

Transmission

(t)(o)() (Set ID)() (Data)(Cr)

Data 00: Locks off all of the keys
01: Locks on all of the keys except the Power key
02: Locks on all of the keys

Acknowledgement

(o)() (Set ID)() (OK/NG)(Data)(x)

- * When the monitor is turned off, the power key works even in the locks on all of the keys (02) mode.

51. [Status] (Command: s v)

Checks the current signal status of the product.

Transmission

(s)(v)() (Set ID)() (Data)() (FF)(Cr)

Data 02: Checks whether there is a signal or not
03: Check the PM mode.
07: Checks whether the Top, Bottom and Main temperature sensors are functioning normally.
09: Fan Speed
10: RGB sensing OK/NG (Check Screen)
13: Door State
15: check the current electric current value
16: Humidity
17: Illuminance
18: Rotation(Gyro) State

Acknowledgement

(v)() (Set ID)() (OK/NG)(Data)(Data1)(x)

Data 02 (when a signal is found)
Data1 00: no signal
01: There is a signal

Data 03 (when checking the PM mode)
Data1 00: The PM mode is set to Screen On
01: The PM mode is set to Screen Off
02: The PM mode is set to Screen Off Always
03: In Sustain Aspect Ratio mode.
04: Screen Off & Backlight status (Outdoor mode)

Data 07 (In the case of checking whether the Top, Bottom and Main temperature sensors are functioning normally)
Data1 00: All temperature sensors are faulty.
01: Top normal, Bottom faulty, Main faulty
02: Top faulty, Bottom normal, Main faulty
03: Top normal, Bottom normal, Main faulty
04: Top faulty, Bottom faulty, Main normal
05: Top normal, Bottom faulty, Main normal
06: Top faulty, Bottom normal, Main normal
07: All temperature sensors are normal

- * The 4th temperature sensor determines whether a malfunction has occurred or not, together with the Top.

Data 10 (Check Screen)
 Data1 00: Check Screen result NG
 07: Check Screen result OK

* Sets to NG when Check Screen is set to Off or not supported.

Data 13 (For checking Door State)
 Data1 Number of the door to check
 Data2 00: Closed
 01: Opened

Data 15 (when checking the current electric current value)
 Data1 Current electric current value in mA

Data 16 (For checking Humidity)
 Data1 Display the current humidity (%RH) in the Hex value

Data 17 (For checking Illuminance)
 Data1 Display the current illumination (Lux) in the Hex value

Data 18 (For checking the Rotation (Gyro) State)
 Data1 00: 0 degrees
 01: 90 degrees
 02: 180 degrees
 03: 270 degrees

Data 09 (In the case of Fan Speed)

Acknowledgement

(v)()(Set ID)()(OK/NG)(Data)(Data1)(Data2)(x)

Data1 00-ff: The upper 1-byte of the fan speed
 Data2 00-ff: The lower 1-byte of the fan speed
 Fan speed: 0 to 2008 in hexadecimal and 0 to 8200 in decimal

* This may not be supported on some models.

52. [Check Screen] (Command: t z)

Sets Check Screen.

Transmission

(t)(z)()(Set ID)()(Data)(Cr)

Data 00: Off
 01: On

Acknowledgement

(z)()(Set ID)()(OK/NG)(Data)(x)

* It may not be supported depending on the model.

53. [Speaker] (Command: d v)

Sets the speaker function.

Transmission

(d)(v)()(Set ID)()(Data)(Cr)

Data 00: Off
 01: On

Acknowledgement

(v)()(Set ID)()(OK/NG)(Data)(x)

* It may not be supported depending on the model.

54. [Daylight Saving Time] (Command: s d)

To set the Daylight Saving Time function.

Transmission

(s)(d)()(Set ID)()(Data1)()(Data2)()(Data3)()(Data4)
 ()(Data5)(Cr)

Data 00: Off (Data2-5: FFH)
 01: Start Time
 02: End Time

Data2 01-0C: January to December
 Data3 01-06: 1-6th week

* The maximum number of [Data3] differs depending on Date.

Data4 00-06 (Sun. ~ Sat.)
 Data5 00-17: 00-23 hours

* To read the Start Time/End Time, enter FFH for [Data2]-[Data5].

(Example 1: sd 01 01 ff ff ff ff - To check the Start Time)

(Example 2: sd 01 02 ff ff ff ff - To check the End Time)

* This function is supported only when 1 (Year/Month/ Day) and 2 (Hour/Minute/Second) are set.

Acknowledgement

(d)()(Set ID)()(OK/NG)(Data1)(Data2)(Data3)(Data4)
 (Data5)(x)

* It may not be supported depending on the model.

55. [PM Mode] (Command: s n, 0c)

Selects the desired PM mode option.

Transmission

(s)(n)()(Set ID)()(0c)()(Data)(Cr)

Data	00: Sets the Power Off mode.
	01: Sets the Sustain Aspect Ratio mode.
	02: Sets the Screen Off mode.
	03: Sets the Screen Off Always mode.
	04: Sets the Screen Off & Backlight mode (Outdoor mode)

Acknowledgement

(n)()(Set ID)()(OK/NG)(0c)(Data)(x)

* It may not be supported depending on the model.

56. [ISM Method] (Command: j p)

Selects the ISM Method option.

Transmission

(j)(p)()(Set ID)()(Data)(Cr)

Data	01: Inversion
	02: Orbiter
	04: White Wash
	08: Normal
	20: Color Wash
	80: Washing Bar
	90: User Image
	91: User Video

* The jp command works when Timer is set to Immediately.

Acknowledgement

(p)()(Set ID)()(OK/NG)(Data)(x)

* It may not be supported depending on the model.

57. [Network Settings] (Command: s n, 80 or 81 or 82)

Configures network and DNS settings.

Transmission

(s)(n)()(Set ID)()(Data1)()(Data2)()(Data3)()(Data4)()(Data5)(Cr)

Data1	80: Configures/views the temporary IP mode (Auto/Manual), subnet mask, and gateway.
	81: Configures/views the temporary DNS address.
	82: Saves temporary settings and views information about the current network.

* If Data1 is 80,

Data2 00: Auto

01: Manual

FF: Views the temporary IP mode (Auto/Manual), subnet mask, and gateway.

** If Data2 is 01 (Manual),

Data3: Manual IP address

Data4: Subnet mask address

Data5: Gateway address

* If Data1 is 81,

Data2: DNS address

FF: Views the temporary DNS address.

* If Data1 is 82,

Data2 80: Applies the temporarily saved IP mode (Auto/Manual), subnet mask, and gateway.

81: Applies the temporary DNS address

FF: Information on the current network (IP, subnet gateway, DNS)

*** Examples of settings

1. Auto: sn 01 80 00

2. Manual: sn 01 80 01 010177223241 255255254000
010177222001 (IP: 10.177.223.241, subnet:
255.255.254.0, gateway: 10.177.222.1)

3. Network read: sn 01 80 ff

4. DNS setting: sn 01 81 156147035018 (DNS: 156.147.35.18)

5. Applying the settings: sn 01 82 80 (applies the saved IP mode
(auto/manual), subnet mask, and gateway)
sn 01 82 81 (applies the saved DSN)

* Each IP address contains 12 decimal digits.

Acknowledgement

(n)()(Set ID)()(OK/NG)(Data1)(Data)(x)

* It may not be supported depending on the model.

* This feature is available only for wired networks.

58. [Auto-adjustment] (Command: j u)

Automatically corrects the position and shaking of the picture. (Works only in RGB-PC input mode.)

Transmission

(j)(u)()(Set ID)()(Data)(Cr)

Data 01: Execution

Acknowledgement

(u)()(Set ID)()(OK/NG)(Data)(x)

* It may not be supported depending on the model.

59. [H Position] (Command: f q)

Adjusts the horizontal position of the screen. This feature only works when the Tile Mode is set to Off.

* The operational range varies depending on the RGB input resolution. (Works only in RGB-PC input mode.)

Transmission

(f)(q)()(Set ID)()(Data)(Cr)

Data 00-64: Min -50 (Left) to Max 50 (Right)

Acknowledgement

(q)()(Set ID)()(OK/NG)(Data)(x)

* It may not be supported depending on the model.

60. [V Position] (Command: f r)

Adjusts the vertical position of the screen. This feature only works when the Tile Mode is set to Off.

* The operational range varies depending on the RGB input resolution. (Works only in RGB-PC input mode.)

Transmission

(f)(r)()(Set ID)()(Data)(Cr)

Data 00-64: Min -50 (Down) to Max 50 (Up)

Acknowledgement

(r)()(Set ID)()(OK/NG)(Data)(x)

* It may not be supported depending on the model.

61. [H Size] (Command: f s)

Adjusts the horizontal size of the screen. This feature only works when the Tile Mode is set to Off.

* The operational range varies depending on the RGB input resolution. (Works only in RGB-PC input mode.)

Transmission

(f)(s)()(Set ID)()(Data)(Cr)

Data 00-64: Min -50 (Small) to Max 50 (Large)

Acknowledgement

(s)()(Set ID)()(OK/NG)(Data)(x)

* It may not be supported depending on the model.

62. [Power On Status] (Command: t r)

Selects the desired Power On status option.

Transmission

(t)(r)()(Set ID)()(Data)(Cr)

Data 00: LST (Stays in the previous status)

01: STD (Stays powered off)

02: PWR (Stays powered on)

Acknowledgement

(r)()(Set ID)()(OK/NG)(Data)(x)

63. [Wake On LAN] (Command: f w)

Selects the desired Wake On LAN option.

Transmission

(f)(w)()(Set ID)()(Data)(Cr)

Data 00: Off

01: On

Acknowledgement

(w)()(Set ID)()(OK/NG)(Data)(x)

64. [Intelligent Auto] (Command: t i)

Selects the desired Intelligent Auto option.

Transmission

(t)(i)()(Set ID)()(Data)(Cr)

Data 00: Off
01: On

Acknowledgement

(i)()(Set ID)()(OK/NG)(Data)(x)

* It may not be supported depending on the model.

65. [OSD Portrait Mode] (Command: t h)

Selects the desired Portrait mode option.

Transmission

(t)(h)()(Set ID)()(Data)(Cr)

Data 00: Off
01: 90 degrees
02: 270 degrees
03: 180 degrees

Acknowledgement

(h)()(Set ID)()(OK/NG)(Data)(x)

* It may not be supported depending on the model.

66. [Reset to Initial Settings] (Command: t n)

Enables/disables the Reset to Initial settings.

Transmission

(t)(n)()(Set ID)()(Data)(Cr)

Data 00: Disables the settings
01: Enables the settings

Acknowledgement

(n)()(Set ID)()(OK/NG)(Data)(x)

* It may not be supported depending on the model.

67. [Time Sync] (Command: s n, 16)

Configures the Time Sync.

Transmission

(s)(n)()(Set ID)()(1)(6)()(Data)(Cr)

Data 00: Off
01: On

* This feature works in the Master mode.

* This feature does not work if the current time is not set.

Acknowledgement

(n)()(Set ID)()(OK/NG)()(1)(6)()(Data)(x)

* It may not be supported depending on the model.

68. [Contents Sync] (Command: t g)

Configures the Contents Sync.

Transmission

(t)(g)()(Set ID)()(Data)(Cr)

Data 00: Off
01: On

Acknowledgement

(g)()(Set ID)()(OK/NG)(Data)(x)

* It may not be supported depending on the model.

69. [Pivot Mode] (Command: t a)

Sets Pivot Mode to on/off.

Transmission

(t)(a)()(Set ID)()(Data)(Cr)

Data 00: Off
01: On

Acknowledgement

(a)()(Set ID)()(OK/NG)(Data)(x)

* This feature may not be supported in certain models.

70. [Studio Mode] (Command: s n, 83)

Sets Studio Mode to on/off.

Transmission`(s)(n)()(Set ID)()(8)(3)()(Data)(Cr)`Data 00: Off
01: On**Acknowledgement**`(n)()(Set ID)()(OK/NG)(8)(3)(Data)(x)`

* This feature may not be supported in certain models.

73. [DPM Wake up Control] (Command: s n, 0b)

Sets the DPM Wake up Control Mode.

Transmission`(s)(n)()(Set ID)()(0)(b)()(Data)(Cr)`Data 00: Clock
01: Clock+DATA**Acknowledgement**`(n)()(Set ID)()(OK/NG)(0)(b)(Data)(x)`

* This feature may not be supported in certain models.

71. [LAN Daisy Chain] (Command: s n, 84)

Sets LAN Daisy Chain to on/off.

Transmission`(s)(n)()(Set ID)()(8)(4)()(Data)(Cr)`Data 00: Off
01: On**Acknowledgement**`(n)()(Set ID)()(OK/NG)(8)(4)(Data)(x)`

* This feature may not be supported in certain models.

74. [Scan Inversion] (Command: s n, 87)

Sets Scan Inversion to on/off.

Transmission`(s)(n)()(Set ID)()(8)(7)()(Data)(Cr)`Data 00: Off
01: On**Acknowledgement**`(n)()(Set ID)()(OK/NG)(8)(7)(Data)(x)`

* This feature may not be supported in certain models.

72. [Content Rotation] (Command: s n, 85)

Sets Content Rotation to on/off.

Transmission`(s)(n)()(Set ID)()(8)(5)()(Data)(Cr)`Data 00: Off
01: 90 degrees
02: 270 degrees
03: 180 degrees**Acknowledgement**`(n)()(Set ID)()(OK/NG)(8)(5)(Data)(x)`

* This feature may not be supported in certain models.

75. [Beacon] (Command: s n, 88)

Sets Beacon to on/off.

Transmission`(s)(n)()(Set ID)()(8)(8)()(Data)(Cr)`Data 00: Off
01: On**Acknowledgement**`(n)()(Set ID)()(OK/NG)(8)(8)(Data)(x)`

* This feature may not be supported in certain models.

76. [Aspect Ratio (Rotation)] (Command: s n, 89)

Controls the Aspect Ratio (Rotation) screen.

(This command works only when Content Rotation is on.)

Transmission

(s)(n)()(Set ID)()(8)(9)()(Data)(Cr)

Data 00: Full
01: Original

Acknowledgement

(n)()(Set ID)()(OK/NG)(8)(9)(Data)(x)

* This feature may not be supported in certain models.

77. [Easy Brightness Control Mode] (Command: s m)

Selects whether to turn on/off Easy Brightness Control Mode.

Transmission

(s)(m)()(Set ID)()(Data)(Cr)

Data 00: Easy Brightness Control off
01: Easy Brightness Control on

* This feature does not work if the current time is not set.

* This may not be supported on some models.

Acknowledgement

(m)()(Set ID)()(OK/NG)(Data)(x)

78. [Easy Brightness Control Schedule] (Command: s s)

Sets Easy Brightness Control schedules.

Transmission

(s)(s)()(Set ID)()(Data1)()(Data2)()(Data3)(Cr)

Data1

1. F1-F6 (reads data)

F1: Reads the 1st data from the Easy Brightness Control

F2: Reads the 2nd data from the Easy Brightness Control

F3: Reads the 3rd data from the Easy Brightness Control

F4: Reads the 4th data from the Easy Brightness Control

F5: Reads the 5th data from the Easy Brightness Control

F6: Reads the 6th data from the Easy Brightness Control

2. FF: Reads all stored lists

3. e1-e6 (deletes one index); e0 (deletes all indexes)

E0: Deletes all Easy Brightness Control.

E1: Deletes the 1st Easy Brightness Control.

E2: Deletes the 2nd Easy Brightness Control.

E3: Deletes the 3rd Easy Brightness Control.

E4: Deletes the 4th Easy Brightness Control.

E5: Deletes the 5th Easy Brightness Control.

E6: Deletes the 6th Easy Brightness Control.

4. 00-17: 00th to 23th hour`

Data2 00-3B: 00th to 59th minute

Data3 00-64: Backlight, 0 to 100

* If you want to read or delete the configured Easy Brightness Control lists, set [Data2][Data3] to FF.

* If you want to import all the configured Easy Brightness Control lists through FF, do not enter any values in [Data2][Data3].

* When all the configured Easy Brightness Control lists are imported through FF, OK is acknowledged even if there is no stored list.

Example 1: ss 01 f1 ff - Reads the first index data from the Easy Brightness Control.

Example 2: ss 01 ff - Reads all index data from the Easy Brightness Control.

Example 3: ss 01 e1 ff ff - Deletes the first index data from the Easy Brightness Control.

Example 4: ss 01 07 1E 46 - Adds a schedule whose time is 07:30 and whose backlight is 70.

Acknowledgement

(s)()(Set ID)()(OK/NG)(Data1)(Data2)(Data3)(x)

* This feature may not be supported in certain models.

79. [MultiScreen Mode & Input] (Command: x c)

Saves or controls the MultiScreen Mode and input.

Transmission`(x)(c)()(Set ID)()(Data1)()(Data2)()(Data3)()(Data4)()(Data5)()Cr`

Data1 (sets the MultiScreen Mode)

- 10: PIP
- 22: PBP2
- 23: PBP3
- 24: PBP4

Data2 (sets the MultiScreen Main Input)

Data3 (sets the MultiScreen Sub1 Input)

Data4 (sets the MultiScreen Sub2 Input)

Data5 (sets the MultiScreen Sub3 Input)

- 20: AV
- 40: COMPONENT
- 60: RGB
- 80: DVI-D
- 90: HDMI1
- 91: HDMI2/OPS
- 92: OPS/HDMI3/DVI-D
- 95: OPS/DVI-D
- 96: HDMI3/DVI-D
- 98: OPS
- C0: DISPLAYPORT

Acknowledgement`(c)()(Set ID)()(OK/NG)()(Data1)(Data2)(Data3)(Data4)(Data5)(x)`

- * This feature may not be supported in certain models.
- * Only the input modes supported by the model works.
- * This feature operates as the last input, and supports data in DTV format.

80. [Aspect Ratio] (MultiScreen) (Command: x d)

Saves or controls the Aspect Ratio (MultiScreen) screen.

Transmission`(x)(d)()(Set ID)()(Data1)()(Data2)Cr`Data1 01: Controls the Main input
02: Controls the Sub1 input
03: Controls the Sub2 input
04: Controls the Sub3 inputData2 00: Full
01: Original**Acknowledgement**`(d)()(Set ID)()(OK/NG)(Data1)(Data2)(x)`

- * This feature may not be supported in certain models.

81. [Screen Mute] (MultiScreen) (Command: x e)

Turns on/off each screen in MultiScreen.

Transmission`(x)(e)()(Set ID)()(Data1)()(Data2)Cr`Data1 01: Controls the Main input
02: Controls the Sub1 input
03: Controls the Sub2 input
04: Controls the Sub3 inputData2 00: Turns the screen on.
01: Turns the screen off.

- * This function works when the Multi Screen App is running.
- * This function may not work properly if there is no signal.

Acknowledgement`(e)()(Set ID)()(OK/NG)(Data1)(Data2)(x)`

- * This feature may not be supported in certain models.

82. [Screen Off Always] (Command: s n, Od)

Screen Off Always has the same effect as entering the Screen Off menu regardless of the PM Mode setting.

Transmission`(s)(n)()(Set ID)()(0)(d)()(Data)Cr`Data 00: Off
01: On**Acknowledgement**`(n)()(Set ID)()(OK/NG)(0)(d)(Data)(x)`

- * This feature may not be supported in certain models.

83. [Screen Video Freeze] (Command: k x)

Turns on/off the video freeze function.

Transmission`(k)(x)()(Set ID)()(Data)Cr`Data 00: Turns on the freeze function.
01: Turns off the freeze function.

- * Available in single input mode.

Acknowledgement`(x)()(Set ID)()(OK/NG)(Data)(x)`

- * This feature may not be supported in certain models.

84. [Wireless Wake-on-LAN] (Command: s n, 90)

Sets Wireless Wake-on-LAN.

Transmission`(s)(n)()(Set ID)()(9)(0)()(Data)(Cr)`Data 00: Off
01: On**Acknowledgement**`(n)()(Set ID)()(OK/NG)(9)(0)(Data)(x)`

* This feature may not be supported in certain models.

85. [JustScan Toggle] (Command: s n, 91)

Sets JustScan.

Transmission`(s)(n)()(Set ID)()(9)(1)()(Data)(Cr)`Data 00: Off
01: On**Acknowledgement**`(n)()(Set ID)()(OK/NG)(9)(1)(Data)(x)`

* This feature may not be supported in certain models.

86. [Holiday Schedule Mode] (Command: s n, 1a)

Turns Holiday Schedule mode on or off.

Transmission`(s)(n)()(Set ID)()(1)(a)()(Data)(Cr)`Data 00: Holiday Schedule off
01: Holiday Schedule on

* This feature does not work if the current time is not set.

* Depending on the model, this feature may not be supported.

Acknowledgement`(n)()(Set ID)()(OK/NG)()(1)(a)()(Data)(x)`**87. [Holiday Schedule] (Command: s n, 1b)**

Configures the Holiday Schedule.

Transmission`(s)(n)()(Set ID)()()(1)(a)``()(Data1)()(Data2)()(Data3)()(Data4)(Cr)`

Data1

1. f1-f7 (Data Reading Functions)

f1: Reads data of 1st Holiday Schedule

f2: Reads data of 2nd Holiday Schedule

f3: Reads data of 3rd Holiday Schedule

f4: Reads data of 4th Holiday Schedule

f5: Reads data of 5th Holiday Schedule

f6: Reads data of 6th Holiday Schedule

f7: Reads data of 7th Holiday Schedule

2. FF: Reads all stored lists

3. e1-e7 (Deletes one index), e0 (Deletes all indexes)

e0: Deletes all Holiday Schedules

e1: Deletes 1st Holiday Schedule

e2: Deletes 2nd Holiday Schedule

e3: Deletes 3rd Holiday Schedule

e4: Deletes 4th Holiday Schedule

e5: Deletes 5th Holiday Schedule

e6: Deletes 6th Holiday Schedule

e7: Deletes 7th Holiday Schedule

4. 01-0c: Month 01 to 12 (Start Month)

Data2 01-1F: Day 01 to 31 (Start Day)

Data3 01-0c: Month 01 to 12 (End Month)

Data4 01-1F: Day 01 to 31 (End Day)

* If you want to read or delete the configured Holiday Schedule lists, set [Data2][Data3][Data4] to FF.

* When reading all configured Holiday Schedule lists, set [Data1][Data2][Data3][Data4] to FF.

Example1: sn 01 1b f1 ff ff ff -- Reads the 1st index data in the Holiday Schedule.

Example2: sn 01 1b ff ff ff ff -- Reads all index data in the Holiday Schedule.

Example3: sn 01 1b e1 ff ff ff -- Deletes the 1st index data in the Holiday Schedule.

Example4: sn 01 1b 01 07 0c 18 -- Adds Holiday Schedule from January 7 to December 24.

* Schedules set beforehand are not added.

* This feature does not work if the current time is not set.

* Depending on the model, this feature may not be supported.

Acknowledgement`(s)()(Set ID)()(OK/NG)(Data1)(Data2)(Data3)(x)`

88. [Dual Screen Off] (Command: s n, 92)

Turn Dual Screen On or Off.

Transmission**(s)(n)() (Set ID)() (9)(2)() (Data)(Cr)**

Data 00: MainScreen – On / SubScreen – On
 01: MainScreen – Off / SubScreen – On
 02: MainScreen – On / SubScreen – Off

Acknowledgement**(n)() (Set ID)() (OK/NG)(9)(2)(Data)(x)**

* This feature may not be supported in certain models.

91. [Luminance Value Read] (Command: m u)

Reads luminance value.

Transmission**(m)(u)() (Set ID)() (FF)(Cr)****Acknowledgement****(u)() (Set ID)() (OK/NG)(Data1)(Data2)(Data3)(Data4)(Data5)(Data6)(Data7)(x)**

Data1 00–64: The Backlight PWM value (0 to 100)

Data2 00–ff: The upper 1-byte of the value measured by the CA210.

Data3 00–ff: The lower 1-byte of the value measured by the CA210.

CA210 measurement: 0000 to ffff in hexadecimal and 0 to 65535 in decimal.

Data4 00–ff: The upper 1-byte of the value measured by BLU 1 sensor.

Data5 00–ff: The lower 1-byte of the value measured by BLU 1 sensor.

Data6 00–ff: The upper 1-byte of the value measured by BLU 2 sensor.

Data7 00–ff: The lower 1-byte of the value measured by BLU 2 sensor.

BLU measurement: 0000 to ffff in hexadecimal and 0 to 65535 in decimal.

* During final assembly, a CA210 measurement is entered through the calibration procedure. The default value, before calibration, is 0.

* This may not be supported on some models.

89. [Fan control] (Command: d o)

Sets the fan mode.

Transmission**(d)(o)() (Set ID)() (Data)(Cr)**

Data 00: Auto
 01: On
 02: Manual
 03: Off

Acknowledgement**(o)() (Set ID)() (OK/NG)(Data)(x)**

* This may not be supported on some models.

92. [BLU Maintenance] (Command: m t)

Selects whether to turn on/off BLU Maintenance.

Transmission**(m)(t)() (Set ID)() (Data)(Cr)**

Data 00: BLU Maintenance Off
 01: BLU Maintenance On

Acknowledgement**(t)() (Set ID)() (OK/NG)(Data)(x)**

* This may not be supported on some models.

90. [Fan Failure Check] (Command: d w)

Checks for fan failures.

Transmission**(d)(w)() (Set ID)() (Data)(Cr)**

Data FF: Read status

Acknowledgement**(w)() (Set ID)() (OK/NG)(Data1)(Data2)(x)**

Data1 00: One or more fans are faulty.
 01: All fans are normal.
 02: The model has no fan.

Data2 00: No fan is faulty (all fans are normal).

01: 1 fan is faulty.

02: 2 fans are faulty.

03: 3 fans are faulty.

04: 4 fans are faulty.

05: 5 fans are faulty.

06: 6 fans are faulty.

07: 7 fans are faulty.

08: 8 fans are faulty.

09: 9 fans are faulty.

0A: 10 fans are faulty.

...

N: N down

93. [Power Indicator] (Command: f o)

Sets the Power Indicator Settings.

Transmission`(f)(o)()(Set ID)()(Data)(Cr)`

Data 00: Off

01: On

Acknowledgement`(o)()(Set ID)()(OK/NG)(Data)(x)`

* This may not be supported on some models.

94. [OSD Display] (Command: k l)

Selects the desired OSD Display option.

Transmission`(k)(l)()(Set ID)()(Data)(Cr)`

Data 00: No (Off)

01: Yes (On)

Acknowledgement`(l)()(Set ID)()(OK/NG)(Data)(x)`

* This feature may not be supported for certain models.

95. [Semi-Transparent Brightness] (Command: s n, 95)

Controls semi-transparent mode LED brightness.

Transmission`(s)(n)()(Set ID)()(9)(5)()(Data)(Cr)`

Data 00-64: LED brightness 0 to 100

Acknowledgement`(n)()(Set ID)()(OK/NG)(9)(5)(Data)(x)`

* This feature may not be supported for some models.

96. [Hybrid Mode] (Command: s n, 96)

Sets display's transparency mode.

Transmission`(s)(n)()(Set ID)()(9)(6)()(Data)(Cr)`

Data 00: Hybrid (effect: Off)

01: Hybrid (effect: Full white)

02: Semi-Transparent

Acknowledgement`(n)()(Set ID)()(OK/NG)(9)(6)(Data)(x)`

* This feature may not be supported for some models.

97. [Return Interval] (Command: s n, 97)

Controls length of time transparent mode is maintained.

Transmission`(s)(n)()(Set ID)()(9)(7)()(Data)(Cr)`

Data 00-0a: Time maintained 0 to 10

Acknowledgement`(n)()(Set ID)()(OK/NG)(9)(7)(Data)(x)`

* This feature may not be supported for some models.

98. [Proximity Sensitivity] (Command: s n, 98)

Sets proximity sensor sensitivity.

Transmission`(s)(n)()(Set ID)()(9)(8)()(Data)(Cr)`

Data 00: High

01: Mid

02: Low

Acknowledgement`(n)()(Set ID)()(OK/NG)(9)(8)(Data)(x)`

* This feature may not be supported for some models.

99. [HDMI IT Contents] (Command: s n, 99)

Uses HDMI data to automatically set Picture Mode.

Transmission

(s)(n)()(Set ID)()(9)(9)()(Data)(Cr)

Data 00: Off
01: On

Acknowledgement

(n)()(Set ID)()(OK/NG)(9)(9)(Data)(x)

* This feature may not be supported for some models.

102. [No Signal Image] (Command: s n, a9)

Turns No Signal Image On or Off.

Transmission

(s)(n)()(Set ID)()(a)(9)()(Data)(Cr)

Data 00: Off
01: On

Acknowledgement

(n)()(Set ID)()(OK/NG)(a)(9)(Data)(x)

* This feature may not be supported on some models.

100. [UPnP Mode] (Command: s n, 9c)

Sets the desired UPnP mode.

Transmission

(s)(n)()(Set ID)()(9)(c)()(Data)(Cr)

Data 00: Off
01: On

Acknowledgement

(n)()(Set ID)()(OK/NG)(9)(c)(Data)(x)

* This feature may not be supported on some models.

* If the UPnP Mode is changed, a reboot will occur.

103. Wi-Fi (Command: s n, 9f)

Set up Wi-Fi.

Transmission

(s)(n)()(Set ID)()(9)(f)()(Data)(Cr)

Data 00: Enable
01: Disable

Acknowledgement

(n)()(Set ID)()(OK/NG)(9)(f)(Data)(x)

* This feature may not be supported on some models.

101. [Model Name check] (Command: f v)

Checks the Model Name.

Transmission

(f)(v)()(Set ID)()(Data)(Cr)

Data FF: Check product serial number

Acknowledgement

(v)()(Set ID)()(OK/NG)(Data)(x)

* Data is in hexadecimal ASCII code.

104. Analog Signage BLU Setting (Command: s n, c2)

Set up Analog Signage BLU.

Transmission

(s)(n)()(Set ID)()(c)(2)()(Data)(Cr)

Data 00: Off
01: On

Acknowledgement

(n)()(Set ID)()(OK/NG)(c)(2)(Data)(x)

* This feature may not be supported on some models.

105. Analog Signage BLU On/Off Time Setting (Command: s n, c3)

Set on/off schedule for Analog Signage BLU.

Transmission

```
(s)(n)( )(Set ID)( )(c)(3)( )(Data1)( )(Data2)( )
(Data3)( )(Data4)( )(Cr)
```

Data1 Set power on schedule (hour)
00-17: 00-23 (hour)

Data2 Set power on schedule (minute)
00-3B: 00-59 (minute)

Data3 Set power off schedule (hour)
00-17: 00-23 (hour)

Data4 Set power off schedule (minute)
00-3B: 00-59 (minute)

Acknowledgement

```
(n)( )(Set ID)( )
(OK/NG)(c)(3)(Data1)(Data2)(Data3)(Data4)(x)
```

* This feature may not be supported on some models.

106. BLU Manual On/Off (Command: s n, c4)

Control on/off for BLU Manual.

Transmission

```
(s)(n)( )(Set ID)( )(c)(4)( )(Data)(Cr)
```

Data 00: Off
01: On

Acknowledgement

```
(n)( )(Set ID)( )(OK/NG)(c)(4)(Data)(x)
```

* This feature may not be supported on some models.

107. Silent fan mode (Command: s n, c7)

Control on/off for BLU Manual.

Transmission

```
(s)(n)( )(Set ID)( )(c)(7)( )(Data)(Cr)
```

Data 00: Off
01: On

Acknowledgement

```
(n)( )(Set ID)( )(OK/NG)(c)(7)(Data)(x)
```

* This feature may not be supported on some models.





INSTALLATION MANUAL

LG Digital

Signage

(MONITOR SIGNAGE)

Please read this manual carefully before operating the your set and retain it for future reference.

webOS 3.0

CONTENTS

ACCESSING INSTALLATION MENU.....4

INSTALLATION MENU5

- Signage Setup.....5

Power On Status

Wake On LAN

LAN Daisy Chain

Power Off Management

Rotation

Beacon

Baudrate (9600/115200)

Power On Delay (0 ~ 250)

Check Screen

Digital Audio Input

Speaker

USB Auto Playback

Interface Selection

OPS Power Control

Multi Display Mode

Power Indicator

Sync Mode

Intelligent Auto

Studio Mode

HDMI IT Contents

White Balance

Application

Web Browser

Status Message

SIMPLINK Setup

Local Dimming

Holiday Schedule

Easy Brightness Control

Analog Signage BLU Setting

Crestron

Enterprise Settings

No Signal Image

Signage 365 Care

Quiet mode (Fan OFF)

Factory Reset

Guide to Using Content Rotation

- USB Cloning.....21

Send to USB

Receive from USB

Logo Image Download

- Password Change.....21

- Fail Over	22	- Server	27
Off		Set Automatically	
Auto		Server IP Type	
Manual		Server IP	
- ISM Method	23	Server Status	
Mode		Port Number	
Repeat		Secured Connection	
Wait		Control Server IP Type	
Duration		Control Server IP	
Repeat Day		Control Server Port	
Start Time		Control Server Status	
End Time		- Lock Mode	28
Action Cycle		USB	
Bar Image		OSD	
Bar Color		Wi-Fi	
Transparency		Reset to Initial Settings	
Direction		IR Operation	
Bar Image Download		Local Key Operation	
User Image Download			
User Video Download			
* How to reset or delete downloaded bar images/user images/user videos			

ACCESSING INSTALLATION MENU

- 1 Press and hold the SETTINGS button for 5 seconds.

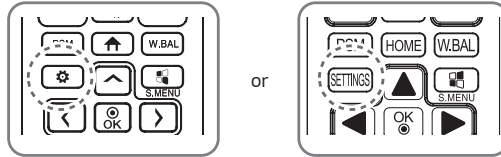

- 2 When Input ID (The top right corner is displayed, enter your password.
(The default value is 0, 0, 0, 0 → )
- 3 When the Installation Menu is displayed, select the desired option.
 - Signage Setup
 - USB Cloning
 - Password Change
 - Fail Over
 - ISM Method
 - Server
 - Lock Mode

NOTE

- Images in the manual may look different from the actual product.

INSTALLATION MENU

NOTE

- Some features described in the Installation manual may not be supported in certain models.

Signage Setup

Use this menu to configure the digital signage after installation.

Power On Status

- You can select the operating status of the monitor when the main power is switched on.
- You can select from among PWR, STD, and LST.
- PWR sets the status of the monitor to on whenever the main power is switched on.
- STD sets the status of the monitor to standby when the main power is switched on.
- LST sets the status of the monitor back to its previous status.

Wake On LAN

- You can set whether to use the Wake On LAN feature.
- You can set the feature to On or Off for each wired/wireless network.
- Wired: When set to On, the Wake On LAN feature is enabled, letting you turn the product on remotely through the wired network.
- Wireless: When set to On, the Wake On LAN feature is enabled, letting you turn the product on remotely through the wireless network.

LAN Daisy Chain

- LAN Daisy Chain forms a daisy chain of LAN ports so that even if you connect only one monitor set to a network, the other sets in the daisy are connected to the network.
- The first set in the daisy chain must be connected to a network through a port that is not being used for the daisy chain.

Power Off Management

- No Signal Power Off (15 Min)
 - You can choose whether to use the 15 min force off feature.
 - You can set this option to On or Off.
 - If you set this option to On, the product turns off when it has remained in no signal status for 15 minutes.
 - If you set this option to Off, the 15 min force off feature is disabled.
 - Set this option to Off when you use the product for a long period of time.
- Auto Power Off
 - You can choose whether to use the 4 hours off feature.
 - You can set this option to 4 Hours or Off.
 - If you set this option to 4 Hours, the product turns off when you have not pressed any buttons on the remote control for 4 hours.
 - If you set this option to Off, the 4 hours off feature becomes disabled.
 - Set this option to Off when you use the product for a long period of time.
- DPM
 - You can configure the DPM (Display Power Management) function.
 - Off: you can set this option to Off, 5 sec./10 sec./15 sec./1 min./3 min./5 min./10 min. (The settings may vary depending on the model.)
 - If this option is not set to Off, the monitor set enters the DPM mode when there is no input signal.
 - If you set this option to Off, the DPM function is disabled.
 - In the cases below, 5 sec. and 10 sec. options will be disabled for DPM. If DPM is already set to 5 sec. or 10 sec., it will be changed to 15 sec.
 1. When USB Auto Playback is set to Photo or Movie (OLED models support the Movie option only)
 2. When Fail Over is set to Auto or Manual
 - If you set this option to 10 sec. or less, the monitor set enters the DPM mode before automatic play of SuperSign contents.
- DPM Wake up Control
 - Turns on the monitor set according to the digital signal processing of the connected DVI-D/HDMI port.
 - Setting this option to Clock only checks for the signals from the digital clock. If there is a clock signal, the monitor set is turned on.
 - Setting this option to Clock+DATA turns on the monitor set only when there are both digital clock signal and data signal inputs.

- PM Mode
 - Power Off: Normal DC off status.
 - Sustain Aspect Ratio: Normal DC off status except that Switching IC stays on. On certain models, this applies only to a specific input mode (DisplayPort) and has the same effect as Screen Off Always in other input modes.
 - Screen Off: Automatically changes to Screen Off status when entering the DPM mode, Auto Off (15 mins, 4 hours), or Abnormal Shut Down.
 - Screen Off Always: Automatically changes to Screen Off status when entering the DPM mode, Auto Off (15 mins, 4 hours), Off Timer, Abnormal Shut Down, or when there is input from the remote control's Power button or the monitor's Off button.
 - To change the screen from Off to On status, there must be input from the remote control's Power or Input button, or the monitor's On button.
 - Screen Off & Backlight (Outdoor Mode): This feature allows the enclosure to function normally in temperatures below zero.

NOTE

- Set to Screen Off & Backlight (Outdoor Mode) when installing outdoors.
- When the Outdoor mode is set, you can reduce the cause for internal humidity and condensation in the product.
- When operating in low temperatures, the enclosure may not work for up to one hour to raise the internal temperature of the enclosure.
- For compatibility of some media input devices, set the Sustain Aspect Ratio.

Rotation

- OSD Portrait Mode
 - This feature allows you to rotate the OSD clockwise.
 - You can set this feature to Off/90/180/270. (Some models only support certain settings.)
 - If you set this feature to Off, the feature is disabled.
 - If you set this feature to 90, the OSD rotates 90 degrees clockwise. In this case, the mouse cannot be used.
 - If you set this feature to 180, the OSD rotates 180 degrees clockwise. In this case, the mouse cannot be used.
 - If you set this feature to 270, the OSD rotates 270 degrees clockwise. In this case, the mouse cannot be used.
 - Depending on the model, you can set this feature to Off/On. If you set this feature to On, the OSD rotates 90 degrees clockwise.
 - Web Browser is deactivated while using OSD Portrait.
- Aspect Ratio (Rotation)
 - Selects an aspect ratio option that will be applied to Content Rotation. (Original/Full)
- Content Rotation
 - Rotates the image clockwise by 90 degrees, 180 degrees, or 270 degrees.
 - When it is set to off, the operation will be disabled.
 - It is recommended that you use content designed to be used in Portrait mode.
 - As for ARC, setting Content Rotation to On (90 or 270) adjusts the size of a video to the full screen size.
 - With WiDi, it is recommended that you set Aspect Ratio to Original if you intend to use Content Rotation. If you set Aspect Ratio to Full, the displayed position of the mouse pointer may not be accurate.
 - Image quality degradation is not a product issue when setting Content Rotation using external input.
 - Setting Content Rotation to On disables the Multi-screen PIP mode.
 - If Content Rotation is set to On (90 or 270 degrees), some widgets and SWF files may not appear properly.
 - If External Input Rotation is enabled on models that support touch, touch may not work properly.

Beacon

- Enables BLE Beacon, one of Bluetooth 4.0's features.
- Beacon Mode (on/off toggle): Enables the Beacon feature.
- Supports LG Beacon/iBeacon/Eddystone Type Beacon features.
- LG Beacon/iBeacon
 - Beacon UUID (hex): Sets the UUID.
 1. Field1: 4byte hex value (8 digits)
 2. Field2: 2byte hex value (4 digits)
 3. Field3: 2byte hex value (4 digits)
 4. Field4: 2byte hex value (4 digits)
 5. Field5: 6byte hex value (12 digits)
 - Major (0-65535): Sets the Major value.
 - Minor (0-65535): Sets the Minor value.
- Eddystone
 - Frame: Sets UUID or URL.
 1. Beacon UUID (hex): Sets the UUID.
 - (1) Field1: 10byte hex value (20 digits)
 - (2) Field2: 6byte hex value (12 digits)
 2. Setting the URL
 - URL Prefix: Sets the prefix of the URL.
 - URL Suffix: Sets the suffix of the URL.
 - URL: Enter the part of the URL that excludes the prefix and suffix.
 - URL string length is limited to 17 characters.
- OK: Confirm button that applies the settings that you have entered.
- Some models do not support background scanning services in iOS.
- A reboot is recommended for the settings to be applied properly.
- The UUID value is hexadecimal and the exact number of digits must be entered.

Baudrate (9600/115200)

- You can change the RS-232C communication speed for controlling your monitor.
- You can choose 9600 or 115200.
- If you set this option to 9600, the RS-232C communication speed is set at 9600 bps.
- If you set this option to 115200, the RS-232C communication speed is set at 115200 bps.

Power On Delay (0 ~ 250)

- This feature delays power on in order to prevent overload when multiple monitor sets are turned on simultaneously.
- You can set the delay interval in the range of 0 to 250 seconds.

Check Screen

- The Check Screen feature judges whether there are abnormalities at the edges of the screen. R, G, and B OSDs are formed on the screen at one second intervals and a Pixel Sensor tests the areas.
- If set to On, the Check Screen feature is enabled.
- If set to Off, the Check Screen feature is disabled.
- When OSD Portrait Mode is applied, Check Screen is turned off and deactivated.
- For enclosure models, the feature is activated regardless of the OSD Portrait setting.

Digital Audio Input

- HDMI/DISPLAYPORT/OPS: You can hear the sounds of the digital signals carried by HDMI, DISPLAYPORT, or OPS through the monitor speakers.
- Audio In: you can hear sounds through the monitor speaker by connecting HDMI, or OPS or DISPLAYPORT ports to the Audio In port.
- If Digital is selected in DVI-D when using OPS/HDMI3/DVI-D or OPS/DVI-D input, there will be no sound.

Speaker

- If you set this option to On, you can hear sounds through the monitor speaker. (* The monitor speaker is sold separately.)
- If you set this option to Off, you cannot hear sounds through the monitor speaker.

USB Auto Playback

- This is a feature that auto-plays photos and videos when a USB device is connected. You can view photos and videos without manually selecting the View Photos/Movies menu. However, this feature is unavailable while the SuperSign contents are played.
- If you select Movie for USB Auto Playback, then the video files in the top level folder on the USB device will automatically play in sequence. When switched on, Signage automatically searches and plays video files from a USB.
- If you select Photo for USB Auto Playback, then the image files in the top level folder on the USB device will automatically play in sequence. When switched on, Signage automatically searches and plays photos from a USB. (This feature is not supported in OLED models.)

Interface Selection

- You can set communication with the connected OPS.
- DISPLAY: Enables communication with external devices via the serial port.
- OPS: Enables communication via the OPS connected to the product.
- Interface Selection is enabled only when the OPS kit is connected.

OPS Power Control

- You can control the power of the OPS.
- Disable: Disables the OPS Power Control.
- Sync (on): Synchronizes the power status of the monitor and the OPS only when monitor is on.
- Sync (on/off): Always synchronizes the power status of the monitor and the OPS.
- When you set the OPS Power Control feature to on, you must set the sustain Aspect Ratio of the PM Mode to off.

Multi Display Mode

- The Multi Display Mode function displays a video signal received from DP In either in single mode (SST: Single Stream Transport) or multi-mode (MST: Multi Stream Transport) through DP Out.
- If it is On, the image of each display is displayed in multi-mode.
- If it is Off, the image of each display is displayed in single mode.
- The multi-mode is available in a PC supporting DisplayPort 1.2.
- Multi-mode can connect up to only four monitors. (at the recommended resolution.)
- When this function is used, your monitor may not work properly depending on the video card. Reboot the PC after setting the function to Off for stable screen output when not in use.
- In case of using DVI/HDMI Input to DP Daisy Chain, please set 'Multi Display mode function' to off.

Power Indicator

- Changes Power Indicator settings.
- If set to On, the Power Indicator is turned on.
- If set to Off, the Power Indicator is turned off.
- While the product is turned on, the Power Indicator is lit for about 15 seconds regardless of whether it is set to On or Off.

Sync Mode

- Syncs the products to the time, brightness and content of one product.
- Off: Sync is disabled.
- RS-232C: Syncs multiple monitors connected via RS-232C.
 - Master/Slave: These monitors can be set to Master or Slave. Only one monitor should be set to Master mode for this feature to work properly.
 - Time Sync: When Time Sync is set to On, the current time of the Master monitor is sent to multiple Slave monitors connected via RS-232C to sync the time. The monitors are synced every hour after the initial sync when Time Sync was set to On. (If any change occurs, there is an initial sync, and then the sync continues every hour.)
 - Contents Sync: When Contents Sync is set to On, the Contents of the Master monitor are sent to multiple Slave monitors connected via RS-232C to sync the Contents. This feature is only available for the monitors with Contents Sync set to On and operates normally with a single video or image in the Contents.
 - Backlight Sync: This feature changes the brightness of the monitor to match that of the Master monitor. Both the Master monitor and Slave monitor must be configured as follows: Energy Saving: Auto and Backlight Sync: On. The brightness sync interval is 1 minute, but when only slight changes in ambient brightness occur, the interval changes to 10 minutes.
- Network: Syncs monitors connected to the same network. The monitor that authorized the SYNC NOW button becomes the Master.
 - How many connected screens: Enter the number of Slaves. A number from 1 to 225 can be entered and the default value is 1.
 - Select storage device: You can select Internal Memory or USB device.
 - Select the file name: Up to 10 files can be selected from the List of files in the selected device. Selecting the files will activate the SYNC NOW button at the top and make the next step available.
 - Only MP4 files are supported, and all files must be located in the SyncPlay folder in the root directory of the device.
 - Before using Network Sync, set the proxy server settings to Off.
- UPnP: Opens or blocks UDP port 1900, which is used for UPnP.
 - The default is On. Setting this to Off blocks UDP port 1900, making the UPnP function unavailable.
 - If this is set to Off, the 'Network' item of Sync Mode becomes inactive.
 - If this is set to Off and Sync Mode was set to 'Network', Sync Mode is switched to 'Off' and the 'Network' item becomes inactive.
 - If the UPnP value is changed, the function is not applied without a reboot.

Intelligent Auto

- Adjusts the size, position, and phase of the monitor's screen automatically at the recognized resolution. This feature is available only in RGB input mode.

Studio Mode

- Outputs the images with a lower color temperature.
- You can set this feature to On or Off.
- Setting this feature to On lowers the color temperature of the images.

HDMI IT Contents

- Sets the HDMI IT Contents function.
- Disable: Does not use the HDMI IT Contents function.
- Enable: Uses the HDMI IT Contents function.
- This function automatically changes the Picture mode based on HDMI Contents information when an HDMI signal is entered.
- Even if the HDMI IT Contents function has changed the Picture mode, you can change the Picture mode manually.
- As this has a higher priority than the Picture mode set by the user, the existing Picture mode may change when the HDMI signal is changed.

White Balance

- Adjusts the R-Gain, G-Gain, B-Gain, and Backlight values.
- Reset: Resets the White Balance value.
- White Pattern: Displays a White Pattern across the entire screen. (80IRE / 100IRE)

Application

- Adds/deletes applications in the Launcher bar.
- We recommend that if you are to remove the Screen Share app from the home launcher by unchecking the Screen Share item, you should reboot your system after removal.
- When Content Rotation or OSD Portrait Mode is set to On, the 'Group Manager' app is removed from the launcher and the 'Group Manager' item is deactivated.
- When the Control Manager is set to On, the Control Manager app will be added to the Launcher bar.
- When the Leveler Tool is set to On, the Leveler Tool app will be added to the Launcher bar.
- If SuperSign Contents is set to On, the "SuperSign Contents" app is added to the Launcher Bar.
- If the SI Server is set to On, the "SI Server" app is added to the Launcher Bar.

Web Browser

- Launches the Chromium browser app and supports simple browsing.
- The browser can perform basic tests for HTML-based apps and has the following properties:
 - Supports basic web page browsing.
 - Does not support additional features that aid the proper display of specific sites (UA Spoofing per site, etc.).
- The browser has the following constraints:
 - Supports mouse and remote control 5-key browsing, but does not support touchpad browsing.
 - Does not support PIP.
 - Does not guarantee the reliability of HTML content outside of the SI app (YouTube, etc.) as it is to be used for test purposes.

Status Message

- Sets up a feature that sends the status of Signage to users' email addresses.
- The administrator can set Status Message to On or Off.
- Messaging Period: Sets a time interval to send messages. You can select either When Failure Status or Weekly.
- Select Date: Available if you have set Messaging Period to Weekly. Select your desired day of the week for message transmission.
- Select Time: Available if you have set Messaging Period to Weekly. Select your desired time for message transmission.
- User E-mail Address: Enter the sender's email address.
- Type: Fixed as POP3.
- Sending Server (SMTP): Enter the POP3 outgoing mail server address and port number.
- ID: Enter the mail server's user ID.
- Password: Enter the mail server's user password.
- Receiver E-Mail Address: Enter the recipient's email address for status messages.
- If the status regarding any of the following items changes or becomes abnormal, a status message can be sent.
 - 1. Temperature: If the monitor set reaches a dangerous temperature, its current temperature is recorded, and an email containing such information is sent.
 - 2. Validity of the temperature sensor: An email is sent if there is no temperature sensor connected, if the communication status of the temperature sensor is unknown, or if the information provided by the chip provider is abnormal.
 - 3. Network Status (Wireless/Wired): An email is sent when the network's connection status is changed. The maximum number of network status changes that can be saved is limited to 50. The saved value is reset once the power turns off.
 - 4. RGB Sensor: An email is sent if the execution of Check Screen by the RGB sensor fails.
 - 5. No Signal Check: Checks whether there is a signal. If there are no signals for more than 10 seconds, an email is sent.
 - 6. Local Contents Schedule: An email is sent if it becomes impossible to play content between the start time and end time of the playback schedule registered in Signage. However, this does not apply when termination was made using the remote control.
 - 7. SuperSign Schedule: An email is sent if it becomes impossible to play content between the start time and end time of the playback schedule distributed to SuperSign. However, this does not apply when termination was made using the remote control.
 - Some of the features above may not be supported on certain models.
- Only SMTP Port 25, 587 is supported; Naver is not supported.

SIMPLINK Setup

- When the SIMPLINK Setup is set to On, you can use the SIMPLINK provided by LG Signage.
- Device ID: Sets the ID of the device connected via CEC wiring. You can choose a value between 'All' and 'E'.
- StandBy: Sets the scenarios for sending and receiving the OpStandBy (0x0c) command. Detailed scenarios are as follows:

	Send	Receive
Send Only	O	X
Receive Only	X	O
All	O	O

Local Dimming

- Sets whether to use the Local Dimming feature.
- You can set this option to On or Off.
- If set to On, Local Dimming is enabled.
- If set to Off, Local Dimming is disabled.
- If Local Dimming is set to Off on a model that supports the Local Dimming feature, the screen's brightness and darkness may not display properly.

Holiday Schedule

- Sets the holidays when the product will not be used.
- Holidays are specified according to your schedule(s).
- You can set this option to On/Off.
- Holiday Schedule is disabled if the current time is not set.
- You can add up to 7 schedules.
- Duplicate schedules cannot be added.
- The On Timer does not work during the period set in Holiday Schedule.

Easy Brightness Control

- Adjusts the backlight according to the schedule you set.
- You can set this option to On/Off.
- Easy Brightness Control is disabled if the current time is not set.
- You can add up to 6 schedules, and they are sorted in ascending order by time.
- You can edit a schedule by selecting it from the list and pressing the OK button.

NOTE

- To revert to the default settings, either go to [Admin] → [Reset to Initial Settings] or [Admin] → [Factory Reset].

Analog Signage BLU Setting

- Sets the function to control the Analog Signage BLU.
- On/Off Time Setting: Adjusts the schedule of the BLU.
- BLU Manual On/Off: Use the On or Off setting to set the BLU to On or Off without being associated with the schedule function.

Crestron

- This function enables synchronization with applications provided by Crestron.
- Server: This menu sets the server's IP address for the network connection with the server (equipment provided by Crestron).
- Port: This menu sets the port for the network connection with the server. The default port number is 41794.
- IP ID: This menu sets a unique ID for synchronizing with the application.

Enterprise Settings

- Enter your company account code to apply the corresponding enterprise settings.
- When your code has been entered, the monitor set gets reset, thereby applying the corresponding enterprise settings.
- This feature does not get activated if a code has already been entered.

No Signal Image

- It changes the image that is output when there is no signal. If you set this feature to off, the no signal image is not displayed.

Signage 365 Care

- You can install the Signage 365 Care (fault diagnosis) solution for fault diagnosis and prediction service.
- Install: Installs the Signage 365 Care solution.
 - 1) ENTER ACCOUNT NUMBER: Enters the 6-digit account number to install the Signage 365 Care solution.
 - Account Number: The number assigned when the Signage 365 Care solution is registered. When the account number is entered, the account name corresponding to the number is obtained.
 - 2) CONFIRM ACCOUNT NUMBER: Displays the account number and the account name corresponding to the account number and validates the account number.
 - If the account number is registered, the account name corresponding to the account number is displayed, and you can continue to install the Signage 365 Care solution.
 - If the account number is not registered, "Unknown" is displayed as the account name, and you cannot continue to install the solution.
- Enable/Disable: Sets whether to Enable/Disable the Signage 365 Care solution.
- Account: Displays user's currently connected account number and name.
- Version: Displays the version of the Signage 365 Care solution.
- Check for Update: Checks for available updates in the server.
- Update: Updates the Signage 365 Care solution to the latest version.
- Server Status: Displays the status of connection between the set and server.
 - Connected: Displayed when the set and server are connected.
 - Not Connected: Displayed when the set and server are disconnected.
 - Waiting for Approval: Displayed when the server is waiting for approval.
 - Rejected: Displayed when the server rejected the connection.
- Reset: Deletes the installed Signage 365 Care solution.

Quiet mode (Fan OFF)

- It is a function to reduce the fan noise.
- On: It lowers the brightness and turns off the fan to operate in the low noise mode.
- Off: The brightness is reverted to the original brightness, and the fan operates in accordance with the internal temperature.

Factory Reset

- You can reset the product to factory settings.

Guide to Using Content Rotation

[Portrait installation setting]

You can turn the image into a portrait image using Content Rotation.

When installing the display rotated 90 degrees: Set Content Rotation to 270.

When installing the display rotated 270 degrees: Set Content Rotation to 90.

Example) When installing the display rotated 90 degrees

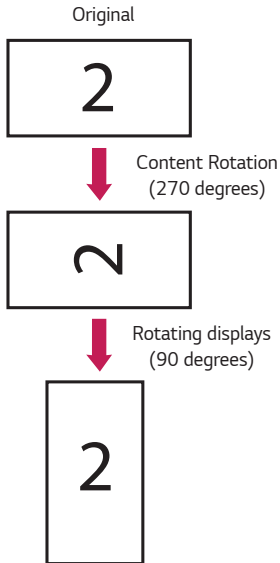

[Video wall installation setting]

You can implement a landscape and portrait video wall using Content Rotation.

Example) Tile mode 2 x 2

* Landscape video wall

* Portrait video wall

- Set Content Rotation to 90

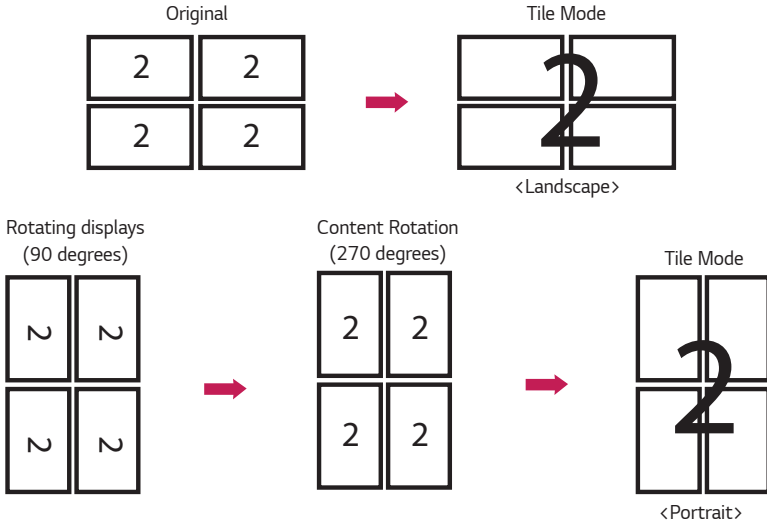

USB Cloning

You can copy the product settings to other sets.

Send to USB

- You can save the current settings in file format to a USB device.
- Select the file name and press the OK button to complete
- Items not saved: Current Time, Power On Delay, Set ID, items under Network, White Balance, Tile ID, current input signal (Input), Signage setup menu - master/slave mode, time sync, all menus in the ISM method menu (except for mode, repeat, wait, and duration), Photo & Video and Music app menus such as picture or sound

Receive from USB

- You can import configuration files from a USB device and change the settings for the current set.
- Using a settings file from a different model may not work properly on this product.
- When import is complete, the power reboots after 5 seconds.

Logo Image Download

- You can download and apply the boot images.
- The image you want to apply must be stored in the LG_MONITOR folder at the top level of a USB device.
- When downloading is complete, the set reboots and the boot image will be applied.

CAUTION

- To use the Configuration Cloning function, be sure to use a USB storage device formatted using the FAT32 file system. If the USB storage device has been formatted with another file system, it may not work correctly.

Password Change

You can change your password in the Installation menu.

You can change your password for security purposes. Enter a new 4-digit password. Enter the same password again in Confirm Password for confirmation.

Fail Over

The input source with the highest priority will be selected.

Off

- The Auto-Fail Over feature is disabled.

Auto

- The input source changes according to the specified order. When several input sources are found, the input source with the highest priority will be selected.
- Priority
Case 1) 1. HDMI, 2. DVI-D, 3. DISPLAYPORT, 4. OPS, 5. RGB, 6. Internal Memory
Case 2) 1. HDMI1, 2. HDMI2, 3. OPS/HDMI3/DVI-D or OPS/DVI-D, 4. DP, 5. Internal Memory

Manual

- The input source changes according to the specified order. When several input sources are found, the input source with the highest priority will be selected.
- You can set Priority 1 - Priority 6.



NOTE

- If the input switches to internal memory, USB or SD card due to Fail Over, the videos or images saved in the top-level directory of the internal memory, USB or SD card will be played.
- If there are both video files and image files in the same folder, then only the video files will be played.
- SuperSign content saved in the Normal or fail_over (FAIL_OVER) folder is played automatically due to Fail Over.
- The number of priorities may vary depending on the model.

ISM Method

If a still image is displayed on the screen for an extended period of time, image sticking can occur. The ISM method is a feature that prevents image sticking.

Mode

- Selects the desired ISM Method mode.
- Normal: Disables the ISM method.
- White Wash: Displays a white pattern to remove image sticking.
- Color Wash: Alternately displays a white pattern and a color pattern to remove image sticking.
- User Image: Displays your desired images using USB.
- User Video: Plays your desired video.
- Inversion: Inverts screen colors to remove image sticking. (This option is disabled when the current input source is No Signal.)
- Washing Bar: Displays a bar on the screen to make the image move smoothly. You can download your desired image and display it on the bar.
- Orbiter: For preventing an afterimage on the screen, when there is one step of movement, it moves by four pixels, and it operates in up to seven steps. The screen moves in the order of left, right, up, and down, and in this case, a part of the outer parts of the screen may be hidden. (When the input is No Signal, it will be inactivated.)

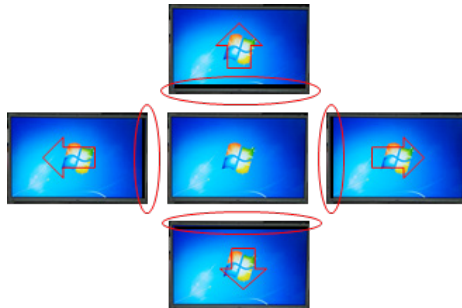

Repeat

- Off, just 1 time: If you select the desired mode and press DONE, ISM operates immediately.
- On: If the screen remains still for a specified wait time, ISM operates for the specified duration time.
- On, with moving detection: Only applies to Orbiter mode. If the screen remains still for the specified Wait time, ISM operates for the specified Duration time.
- On, without moving detection: Only applies to Orbiter mode. ISM immediately starts operating and continues to operate as soon as the DONE button is clicked.
- Scheduling: Performs the ISM function according to settings in date, start time and end time.

Wait

- You can set the time between 1–24 hours.
- This option is available only when you have set Repeat to On.
- The ISM feature starts when the image freezes for a specified period of time.

Duration

- You can select from among 1–10 mins/20 mins/30 mins/60 mins/90 mins/120 mins/180 mins/240 mins.
- This option is available only when you have set Repeat to On.
- ISM operates for the specified time.

Repeat Day

- You can set the date.
- This option is available only when Repeat is set to Scheduling.

Start Time

- Set the Start time.
- This option is available only when Repeat is set to Scheduling.
- You cannot set the same time for Start time and End time.

End Time

- Set the End time.
- This option is available only when Repeat is set to Scheduling.
- You cannot set the same time for Start time and End time.

Action Cycle

- You can select from among 1–10 mins/20 mins/30 mins/60 mins/90 mins/120 mins/180 mins/240 mins.
- This option is available only when you have selected Inversion or Orbiter.
- Orbiter: Moves the position of the screen at specified intervals.
- Inversion: Inverts the screen color at specified intervals.

Bar Image

- Off: Displays a bar with a fixed resolution of 300 x 1080, then moves the bar.
- On: Displays and moves an image downloaded by the user. The image is displayed with a fixed height of 1080 and the same width as downloaded. However, if the width of the image is below 300, it will have a fixed value of 300.
- This option is available only when you have selected Washing Bar.
- If you have downloaded only one image, the bar is moved and the image is displayed alone.
- If you have downloaded multiple images, up to four images are displayed in sequence per cycle.

Bar Color

- You can choose from six colors: red, green, blue, white, black, and gray.
- This feature is only applicable when Bar Image is set to Off.
- This option is available only when you have selected Washing Bar.

Transparency

- Off: Displays the bar opaquely.
- On: Displays the bar translucently. (Transparency: 50 %)
- This option is available only when you have selected Washing Bar.

Direction

- Left To Right: The bar is moved from left to right.
- Right To Left: The bar is moved from right to left.
- This option is available only when you have selected Washing Bar.

Bar Image Download

- To download an image, the image file must be located under the folder titled "ISM" on your USB drive.
- Make sure to delete the old images stored in the internal memory before downloading a new image file.
- Supported image file types: "BMP", "JPG", "JPEG", "PNG"
- You can download up to four images. (Resolution: 1920 x 1080 or lower)
- If there are no images, or if the existing images have been deleted, the default image is used. (The default image is an image of a white bar.)
- This option is available only when Bar Image is On.

User Image Download

- To download an image, the image file must be located under the folder titled "ISM" on your USB drive.
- Make sure to delete the old images stored in the internal memory before downloading a new image file.
- Supported image file types: "BMP", "JPG", "JPEG", "PNG"
- You can download up to four images. (Resolution: 1920 x 1080 or lower)
- If there are no images, or if the existing images have been deleted, the default image is used. (The default image is a white background image.)
- This option is available only when you have selected User Image.

User Video Download

- To download a video, the video file must be located under the folder titled "ISM" on your USB drive.
- Make sure to delete the old contents stored in the internal memory before downloading a new video file.
- Supported video file types: "MP4", "AVI", "FLV", "MKV", "MPEG", "TS"
- You can download up to one video.
- If there are no videos, or if the existing videos have been deleted, the default video is used. (The default video is a white background image.)
- This option is available only when you have selected User Video.
- Audio is not supported.

* How to reset or delete downloaded bar images/user images/user videos

- To reset, go to Installation > Signage Setup > Factory Reset.
- To delete, go to Internal Memory under My Media's Devices item and delete the desired downloaded content.

Server

Set Automatically

- The monitor settings will be set automatically so that the SuperSign server can search it.

Server IP Type

- Select the IPv4 or the IPv6 type.

Server IP

- This is a menu where you can set an IP address for the SuperSign server.

Server Status

- Server Status displays the status of the connection between your monitor and the SuperSign server.
- Not Connected - indicates that your monitor is not connected to the SuperSign server.
- Waiting for Approval - indicates that your monitor is connected to the SuperSign server but not yet approved.
- Rejected - indicates that your monitor is connected to the SuperSign server but has been rejected.
- Connected - indicates that your monitor is connected to the SuperSign server and has been approved.

Port Number

- Sets the SuperSign server's port. (Supported on SuperSign Premium 1.0 or later)

Secured Connection

- You can choose whether to use security protocols when connecting to the SuperSign server. (Supported on SuperSign Premium 1.0 or later)

Control Server IP Type

- Select the IPv4 or the IPv6 type.

Control Server IP

- This menu is to set the IP of the SuperSign Control Server.

Control Server Port

- This menu is to set the port of the SuperSign Control Server.

Control Server Status

- This displays the status of connection with the SuperSign Control Server.
- Not Connected: When not connected to the SuperSign Control Server
- Waiting for Approval: When connected to the SuperSign Control Server but not approved
- Connected: When connected to the SuperSign Control Server and approved

Lock Mode

USB

- You can prevent the use of USB devices.

OSD

- You can prevent OSD from displaying.

Wi-Fi

- This feature enables you to turn the Wi-Fi feature on or off.

Reset to Initial Settings

- You can restore the initial settings with this feature.

IR Operation

- If you set IR Operation to Normal, you can use the remote control.
- If you set IR Operation to Power Key Only, you can only use the Power Key.
- If you set IR Operation to Block All, you cannot use the remote control. (Power On feature is available.)

Local Key Operation

- If you set Local Key Operation to Normal, you can use the Local Key.
- If 'Local Key Operation' is set to Power Key Only, only the Power Key can be used. (The joystick will function as the Power Key if you press and hold the Local Key.)
- If you set Local Key Operation to Block All, you cannot use the Local Key. (Power On feature is available.)

