



# OWNER'S MANUAL

# FRIDGE

---



Before beginning installation, read these instructions carefully. This will simplify installation and ensure that the product is installed correctly and safely. Leave these instructions near the product after installation for future reference.

## ENGLISH

GP-R386PL / GP-R386MBL



MFL71737134  
Rev.02\_050924

[www.lg.com](http://www.lg.com)

Copyright © 2021-2024 LG Electronics Inc. All Rights Reserved.

# TABLE OF CONTENTS

This manual may contain images or content that may be different from the model you purchased.  
This manual is subject to revision by the manufacturer.

## SAFETY INSTRUCTIONS

READ ALL INSTRUCTIONS BEFORE USE.....3  
WARNING .....3  
CAUTION .....9

## INSTALLATION

Before Installation .....10  
Levelling the Appliance .....12  
Turning on the Power.....13  
Moving the Appliance For Relocation.....13

## OPERATION

Before Use .....14  
Product Features.....16  
Control Panel .....18  
Door Handle .....19  
Fridge Drawer.....20  
Door Basket .....22  
Shelf .....22  
Bottle Rack .....22

## SMART FUNCTIONS

LG ThinQ Application .....24  
Smart Diagnosis .....25

## MAINTENANCE

Cleaning .....27  
Air Filter .....27

## TROUBLESHOOTING

Before Calling for Service.....29

# SAFETY INSTRUCTIONS

## READ ALL INSTRUCTIONS BEFORE USE

The following safety guidelines are intended to prevent unforeseen risks or damage from unsafe or incorrect operation of the appliance. The guidelines are separated into 'WARNING' and 'CAUTION' as described below.

### Safety Messages



This symbol is displayed to indicate matters and operations that can cause risk. Read the part with this symbol carefully and follow the instructions in order to avoid risk.



#### **WARNING**

This indicates that the failure to follow the instructions can cause serious injury or death.



#### **CAUTION**

This indicates that the failure to follow the instructions can cause the minor injury or damage to the product.

## WARNING

### **WARNING**

- To reduce the risk of explosion, fire, death, electric shock, injury or scalding to persons when using this product, follow basic precautions, including the following:

### Technical Safety

- This appliance is not intended for use by persons (including children) with reduced physical, sensory or mental capabilities, or lack of experience and knowledge, unless they have been given supervision or instruction concerning use of the appliance by a person

responsible for their safety. Children should be supervised to ensure that they do not play with the appliance.

- Do not damage the refrigerant circuit.
- Do not use mechanical devices or other means to accelerate the defrosting process.
- Keep ventilation openings, in the appliance enclosure or in the built-in structure, clear of obstruction.
- Do not use electrical appliances inside the food storage compartments of the appliance, unless they are of the type recommended by the manufacturer.
- The refrigerant and insulation blowing gas used in the appliance require special disposal procedures. Consult with service agent or a similarly qualified person before disposing of them.
- This appliance is intended to be used in household and similar applications only. It should not be used for commercial, or catering purposes, or in any mobile application such as a caravan or boat.
- This appliance is not for use in portable or mobile installations, such as marine or RV uses, where it will be in motion while operating.
- Do not store explosive substances such as aerosol cans with a flammable propellant in this appliance.



This symbol alerts you to flammable materials that can ignite and cause a fire if you do not take care.

- This appliance contains a small amount of isobutane refrigerant (R600a), but it is also combustible. When transporting and installing the appliance, care should be taken to ensure that no parts of the refrigerating circuit are damaged.
- When positioning the appliance, ensure the supply cord is not trapped or damaged.
- If the power cord is damaged or the hole of the outlet socket is loose, it must be replaced. Do not use the power cord and contact an authorized service centre in order to avoid a hazard.

- Do not locate multiple portable socket-outlets or portable power supplies at the rear of the appliance.
- Disconnect the power cord before cleaning the appliance interior or exterior.
- Securely plug the power plug in the outlet socket after completely removing any moisture and dust.
- Never unplug the appliance by pulling on the power cable. Always grip the power plug firmly and pull straight out from the outlet socket.
- Do not spray water or inflammable substances (toothpaste, alcohol, thinner, benzene, flammable liquid, abrasive, etc.) over the interior or exterior of the appliance to clean it.
- Do not clean the appliance with brushes, cloths or sponges with rough surfaces or which are made of metallic material.
- Only qualified service personnel from LG Electronics service centre should disassemble, repair, or modify the appliance. Contact an LG Electronics customer information centre if you move and install the appliance in a different location.
- Do not use a hair drier to dry the inside of the appliance or place a candle inside to remove the odours.
- Do not tilt the appliance to pull or push it when transporting.
- Make sure not to get a body part such as a hand or foot stuck while moving the appliance.
- Consult with a service agent or a similarly qualified person about the recovery of refrigerant and recycling of components on disposal of the refrigerating appliance.

### **Risk of Fire and Flammable Materials**

- If a leak is detected, avoid any naked flames or potential sources of ignition and air the room in which the appliance is standing for several minutes. In order to avoid the creation of a flammable gas air mixture if a leak in the refrigerating circuit occurs, the size of the room in which the appliance is used should correspond to the

amount of refrigerant used. The room must be 1 m<sup>2</sup> in size for every 8 g of R600a refrigerant inside the appliance.

- Refrigerant leaking out of the pipes could ignite or cause an explosion.
- The amount of refrigerant in your particular appliance is shown on the identification plate inside the appliance.

### **Installation**

- This appliance should only be transported by two or more people holding the appliance securely.
- Install the appliance on a firm and level floor.
- Do not install the appliance in a damp and dusty place. Do not install or store the appliance in any outdoor area, or any area that is subject to weathering conditions such as direct sunlight, wind, rain, or temperatures below freezing.
- Do not place the appliance in direct sunlight or expose it to the heat from heating appliances such as stoves or heaters.
- Be careful not to expose the rear of the appliance when installing.
- Install the appliance in a place where it is easy to unplug the power plug of the appliance.
- In the event that a door needs to be removed to pass the unit through a doorway, be careful not to let the appliance door fall during assembly or disassembly.
- Be careful not to pinch, crush, or damage the power cable during assembly or disassembly of the appliance door.
- Be careful not to point the power plug up or let the appliance lean against the power plug.
- Do not connect a plug adapter or other accessories to the power plug.
- Do not modify or extend the power cable.
- Ensure that the outlet socket is properly grounded, and that the earth pin on the power cord is not damaged or removed from the power

plug. For more details on grounding, inquire at an LG Electronics customer information centre.

- This appliance is equipped with a power cord having an equipment-grounding conductor and a grounding power plug. The power plug must be plugged into an appropriate outlet socket that is installed and grounded in accordance with all local codes and ordinances.
- Never start up an appliance showing any signs of damage. If in doubt, consult your dealer.
- Dispose of all packaging materials (such as plastic bags and styrofoam) away from children. The packaging materials can cause suffocation.
- Do not plug the appliance into multiple outlet sockets, power boards, or an extension power cable.
- Do not use an extension cord or double adapter.

## Operation

- Do not use the appliance for any purpose (storage of medical or experimental materials or temperature strict medicines) other than any domestic household food storage use.
- If water penetrates electrical parts of the appliance, disconnect power plug and contact an LG Electronics customer information centre.
- Unplug the power plug during a severe lightening or thunderstorm or when not in use for a long period of time.
- Do not touch the power plug or the appliance controls with wet hands.
- Do not bend the power cable excessively or place a heavy object on it.
- Immediately unplug the power plug and contact an LG Electronics customer information centre if you detect a strange sound, odour, or smoke coming from the appliance.
- Do not place hands or metallic objects inside the area emitting the cold air, covers or heat releasing grille on the back.
- Do not apply excessive force or impact to the back cover of the appliance.

- Be careful of nearby children when you open or close the appliance door. The door may bump the child and cause injury.
- Avoid the danger of children getting trapped inside the appliance. A child trapped inside the appliance can cause suffocation.
- Do not put animals, such as pets into the appliance.
- Do not place heavy or fragile objects, containers filled with liquid, combustible substances, flammable objects (such as candles, lamps, etc.), or heating devices (such as stoves, heaters, etc.) on the appliance.
- Do not place any electronic appliance (such as heater and mobile phone) inside the appliance.
- If there is a gas leakage (isobutane, propane, natural gas, etc.), do not touch the appliance or power plug and ventilate the area immediately. This appliance uses a refrigerant gas (isobutane, R600a). Although it uses a small amount of the gas, it is still combustible gas. Gas leakage during appliance transport, installation or operation can cause fire, explosion or injury if sparks are caused.
- Do not use or store flammable or combustible substances (ether, benzene, alcohol, chemical, LPG, combustible spray, insecticide, air freshener, cosmetics, etc.) near the appliance.
- This appliance incorporates an earth connection for functional purposes.
- Fill with potable water only.
  - If using a dispenser water tank, make sure to fill it with potable water only.

### **Disposal**

- When discarding the appliance, remove the door gasket while leaving the shelves and baskets in place and keep children away from the appliance.

## CAUTION

### CAUTION

- To reduce the risk of minor injury to persons, malfunction, or damage to the product or property when using this product, follow basic precautions, including the following:

## Operation

- The tempered glass on the front side of the appliance door or the shelves can be damaged by an impact. If it is broken, do not touch it with hands.
- Do not hang from the appliance doors, door baskets, storage compartments or shelves, or climb up into the appliance.
- Do not store an excessive amount of water bottles or containers in the door baskets.
- Do not open or close the appliance door with excessive force.
- If the hinge of the appliance door is damaged or operates improperly, stop using the appliance and contact an authorized service centre.
- Prevent animals from nibbling on the power cable or water hose.
- Make sure not to get a hand or foot stuck upon opening or closing the appliance door or door in door.

## Maintenance

- This appliance is equipped with maintenance-free LED interior light. Do not remove cover or LED lamp in any attempt to repair or change it. Contact an LG Electronics customer information centre.
- Do not clean glass shelves or covers with warm water when they are cold. They may shatter if exposed to sudden temperature changes.
- Do not insert the shelves upside down. The shelves may fall.
- To remove frost from the appliance, contact an LG Electronics customer information centre.

# INSTALLATION

## Before Installation

### Dimensions and Clearances

Too small of a distance from adjacent items may result in the degradation of freezing capability and increased electricity costs. Allow over 50 mm of clearance between the back of the appliance and the wall when installing the appliance.

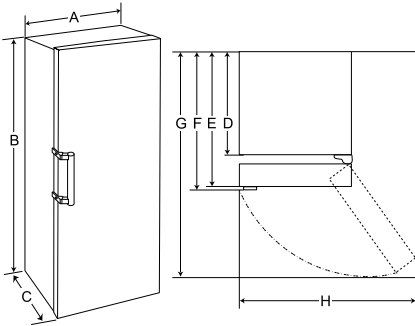

-	Size (mm)
A	595
B	1860
C	707
D	600
E	666
F	707
G	1225
H	816

### NOTE

- You can determine what type of appliance it is by looking at the label inside the appliance.
- Insulation materials of the appliance may contract or expand in response to temperature

changes. This may result in decrease or increase of the appliance width.

### Ambient Temperature

- The appliance is designed to operate within a limited range of ambient temperatures, depending on the climate zone.
- The internal temperatures could be affected by the location of the appliance, the ambient temperature, the frequency of door opening and so on.
- The climate class can be found on the rating label.

Climate Class	Ambient Temperature Range °C
SN (Extended Temperate)	+10 - +32
N (Temperate)	+16 - +32
ST (Subtropical)	+16 - +38 / +18 - +38**
T (Tropical)	+10 - +43* / +16 - +43 / +18 - +43**

\* Australia, India, Kenya

\*\* Argentina

### NOTE

- The appliances rated from SN to T are intended to be used at an ambient temperature between 10 °C and 43 °C.

## Accessories

\*1 This feature is only available on some models.

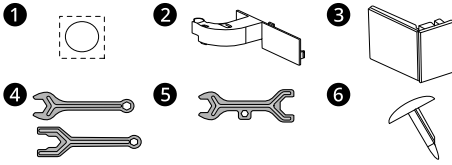

- 1 Sticker\*1
- 2 Cord Holder\*1
- 3 Hinge Cover\*1
- 4 Spanner A\*1
- 5 Spanner B\*1
- 6 Door Cap\*1

## Reversing Doors

This feature is only available on some models. Your appliance is designed with reversible doors, so that they may open from either the left or right hand side to suit your kitchen design.

### NOTE

- Reversing the doors must be performed by the qualified personnel of LG Electronics. If not, the doors will not be covered by the warranty.

## Connecting the Freezer and Fridge

This feature is only available on some models.

You can install your appliance in pairs by calling to the LG Electronics service centre.

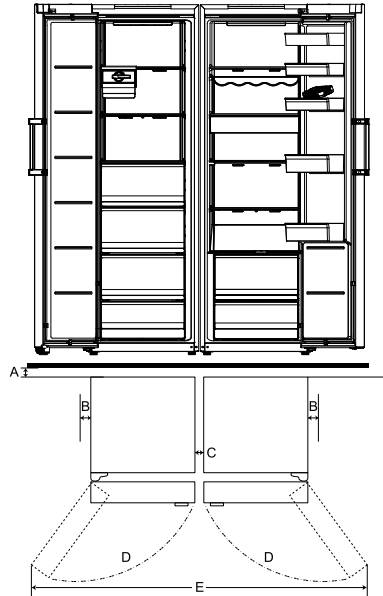

-	Size (mm)
A	Minimum 50
B	50
C	11
D	110°
E	1643

### NOTE

- Installation condition is not covered by the warranty.
- Connecting the freezer and fridge may increase energy consumption.

## Levelling the Appliance

### Before Beginning

When the appliance doors appear to be uneven, follow the instructions below to align the doors.

#### NOTE

- The spanner may differ depending on the model. You will be provided with either spanner type A or B.

- Spanner Type A

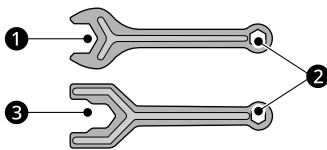

- Spanner Type B

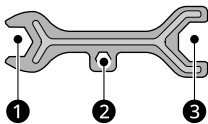

- Open the doors and check to make sure that they close easily.

### Door Alignment

If the door of the appliance is not level, adjust the difference in the height of appliance door.

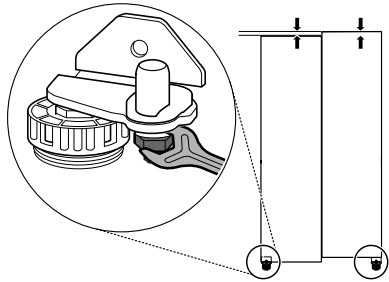

- Open the door and use the spanner 1 to loosen the keeper nut by turning it to the left.

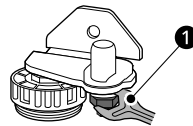

- Use the spanner 2 to adjust the height by turning the adjustment hinge pin to the left or to the right.

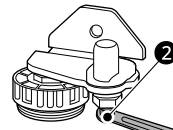

### Adjusting the Levelling Leg

If the appliance seems unsteady, or the doors do not close easily, adjust the appliance's tilt using the instructions below.

- Turn the levelling leg clockwise to raise that side of the appliance or counterclockwise to lower it.

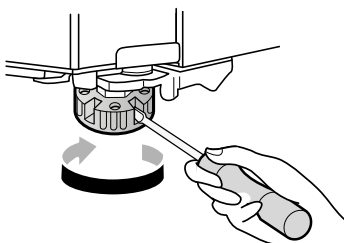

#### CAUTION

- Do not adjust the height of the appliance door more than 3 mm.

- Use the spanner ① to fasten the keeper nut by turning it to the right.

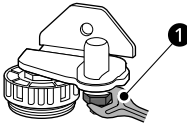

**NOTE**

- Leveling the doors may not be possible when the floor is not leveled, or is of weak or poor construction.
- The refrigerator is heavy and should be installed on a rigid and solid surface.
- Some timber flooring may cause levelling difficulties if it flexes excessively.

- Fix the power plug.

- Models with a power plug hook:  
Pull the power plug out, insert and fix it into the power plug hook at the rear or on top of the appliance.
- Models without a power plug hook:  
Pull the power plug out and fix the power supply cable with a tape to the side of the appliance where the power socket is located at the installation site.

- Tape parts such as shelves and the door handle to prevent from falling off while moving the appliance.

- Move the appliance with more than two people carefully. When transporting the appliance over a long distance, keep the appliance upright.

## Turning on the Power

### Connecting the Appliance

To turn on the appliance, connect the power plug into the outlet socket. Do not double up with other appliances on the same outlet.

**NOTE**

- After connecting the power supply cord (or plug) to the outlet, wait 3 or 4 hours before you put food into the appliance. If you add food before the appliance has cooled completely, your food may spoil.
- To turn off the appliance, disconnect the power plug from the outlet socket.

**⚠ CAUTION**

- Move the appliance carefully on sensitive floors to avoid damage to the floor.
  - Use cardboard, floor mat or carpet to prevent scratches on the floor when installing or moving the appliance.
  - Do not move the appliance in zigzags.

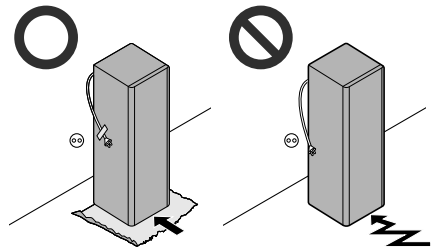

## Moving the Appliance For Relocation

### Moving the Appliance

- Remove all food from inside the appliance.

- After installing the appliance, connect the power plug into a mains outlet socket and switch it on.

# OPERATION

## Before Use

### Notes for Operation

- Ensure there is sufficient space between food stored on the shelf or door basket to allow the door to close completely.
- Opening the door for long periods can cause a significant increase of the temperature in the compartments of the appliance.
- If you are leaving the appliance turned off for an extended period of time, remove all food and unplug the power cord. Clean the interior, and leave the doors slightly ajar to prevent mould from growing in the appliance.

## Door Open Alarm

This feature is only available on some models. The alarm sounds if the door is left open or not completely closed.

---

### NOTE

- Contact the LG Electronics customer information centre if the alarm sound continues even after closing all doors.
- 

## Failure Detection

The appliance can automatically detect problems during the operation.

---

### NOTE

- If a problem is detected, the appliance may not operate and an error code is displayed even when any button is pressed.
  - If an error code is indicated on the display, do not turn off the power. Immediately contact the LG Electronics customer information centre and report the error code. If you turn off the power, the repair technician from the our information centre may have difficulty finding the problem.
- 

## Suggestion for Energy Saving

- For the most efficient use of energy, keep all inner parts (e.g. door bins, drawers and shelves) on their original location. Altering their positions may result in less efficient energy consumption or performance.
- Do not set the temperature of the appliance lower than needed.
- Ensure there is sufficient space between stored foods. This allows cold air to be circulated evenly and lowers electricity bills.
- Store hot food only after it has cooled in order to prevent dew.
- Do not put food near the temperature sensor of the fridge compartment. Keep a distance of at least 3 cm from the sensor.

## Storing Foods Effectively

- This appliance is not suitable for freezing food.
- Food may freeze or spoil if stored at the wrong temperature. Set the refrigerator to the correct temperature for the food being stored.
- Store refrigerated food inside sealed containers.
- Check the expiration date and label (storage instructions) before storing food in the appliance.
- Do not store food for a long period of time if it spoils easily at a low temperature.
- Place the refrigerated food in fridge compartment immediately after purchasing.
- Store raw meat and fish in suitable containers in the refrigerator, so that it is not in contact with or drip onto other food.
- Refrigerated foods and other food items can be stored on top of the vegetable drawer.
- Cool hot food before storing. If too much hot food is placed inside, the internal temperature of the appliance can increase and negatively affect other foods stored in the appliance.
- Do not overfill the appliance. Cold air can not circulate properly if the appliance is overfilled.

- If you set an excessively low temperature for food, it may become frozen. Do not set a temperature lower than the required temperature for the food to be stored correctly.
- If there are chill compartments in the appliance, do not store vegetables and fruits with higher moisture content in the chill compartments as they may freeze due to the lower temperature.
- In the event of a blackout, call the electricity company and ask how long it is going to last.
  - You should avoid door openings while the power is off.
  - When the power supply gets back to normal, check the condition of the food.

# Product Features

The appearance or components of the appliance may differ from model to model.

## Interior

\*1 This feature is only available on some models.

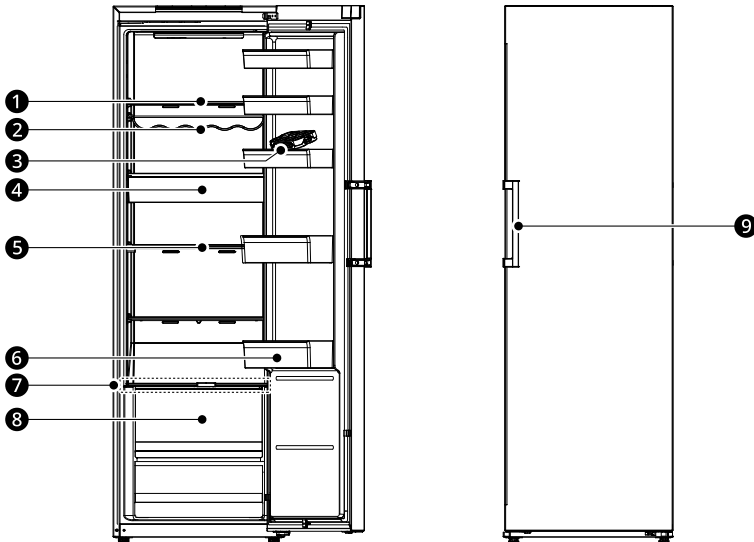

### ❶ Fridge Shelf

Stores refrigerated foods and fresh foods.

- Stores the foods with higher moisture content at the front of the shelf.
- The shelf height can be adjusted by inserting the shelf in another groove of different height.
- The actual number of shelves will differ from model to model.

### ❷ Bottle Rack

Tall bottles can be stored horizontally using the bottle rack.

---

## ⚠ CAUTION

- Do not store short bottles on the bottle rack. The items may fall and cause an injury or appliance damage.

### ❸ Egg Tray

Stores eggs.

- You can move this egg tray to a desired position except for the top shelf of the fridge or the vegetable drawer.

### ❹ Snack Drawer\*1

Stores dairy foods such as butter and cheese.

**5 Folding Shelf**\*1

The fridge shelves are adjustable to meet individual storage needs.

**6 Door Basket**

Stores small packages of refrigerated foods, drinks and sauce containers.

**7 Bottom Shelf (Drawer Cover)**\*1

Stores refrigerated foods and fresh foods.

---

**⚠ CAUTION**

- Do not store any items at the front of the bottom shelf. The items may fall and cause an injury or appliance damage.

---

**8 Fresh Balancer**\*1

Helps vegetables and fruit to stay crisp and controls humidity.

**9 Door Handle**

Pull the handle to open the door.

# Control Panel

The actual control panel may differ from model to model.

## Control Panel and Functions

\*1 This feature is only available on some models.

**Type 1. On the Fridge Door**

**Type 2. Inside the Fridge**

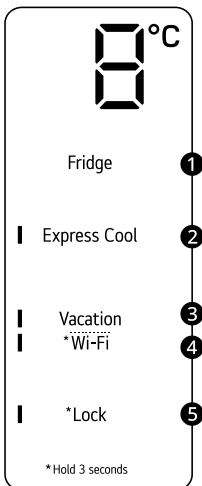
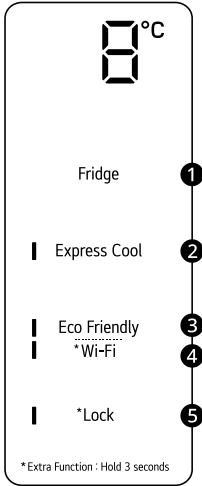

Press this button repeatedly to select a desired temperature between 1 °C and 7 °C.

- The default fridge temperature is 3 °C.

## 2 Express Cool

This function can quickly cool a large amount of foods such as vegetable, fruit and so on.

## 3 Vacation

This function is useful when you are away on a holiday. When this function is on, the fridge temperature is 7 °C. When this function is off, the fridge temperature return to the previous temperature settings.

- This function is enabled and disabled in turn each time you press the button.
- When this function is on, the other buttons except **Lock** and **Wi-Fi** buttons will not operate.
- **Eco Friendly** has been renamed **Vacation**.

## ! CAUTION

- When this function is on, be careful about storing foods that require a lower temperature than the default temperature.
- When you return home, remember to turn this function off to unlock the other buttons and return the refrigerator to its previous temperature settings.

## 4 Wi-Fi\*1

The **Wi-Fi** button, when used with the **LG ThinQ** app, allows the refrigerator to connect to a home Wi-Fi network. Refer to **Smart Functions** for information on the initial setup of the application.

- Press and hold the **Wi-Fi** button for 3 seconds to connect to the network.

## 5 Lock\*1

The lock function disables every other button on the display.

- When power is initially connected to the refrigerator, the lock function is off.
- To lock the control panel buttons, press and hold the **Lock** button for 3 seconds and the function is activated.
- To disable the function, press and hold the **Lock** button for 3 seconds.

## NOTE

- For optimal food preservation, increasing or decreasing 1 °C from the default temperature is recommended.
- The control panel will turn off automatically for energy saving.
- If there is any finger or skin contacts to the control panel while cleaning it, the button function may operate.

## Door Handle

The appearance or components of the appliance may differ from model to model.

### Using Easy Open Door

To easily open the door, hold the handle and softly turn it to the left.

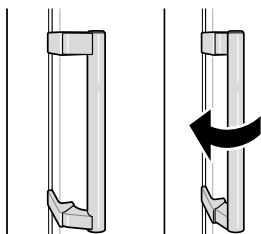

- 2 Place the cover upside down on the floor and slide the crisper cover **1** to the right and then remove it.

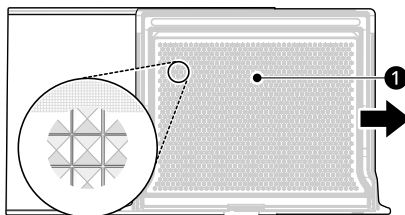

### Fridge Drawer

#### Removing/Assembling the Drawer Cover

This feature is only available on some models.

#### Removing the Cover

- 1 Open the door completely. Hold the cover with both hands and tilt the cover slightly while pulling it out.

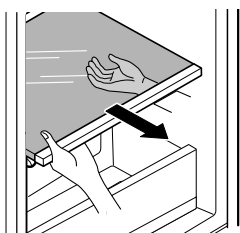

#### Assembling the Cover

- 1 Assemble the knob of the vegetable compartment **2**.

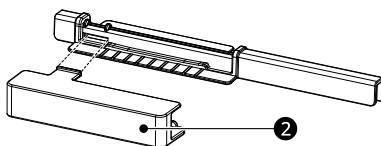

- 2 Insert the knob **3** into the crisper cover.

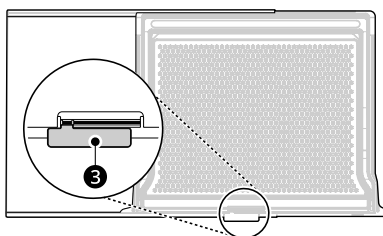

- 3** Slide the crisper cover to the left and then refit it.

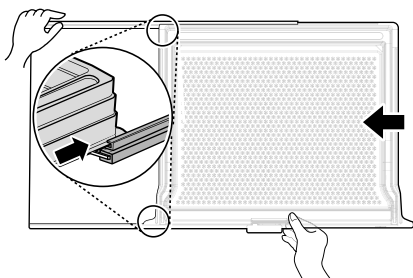

- 4** Hold the cover with both hands and tilt the cover slightly while refitting.

## Removing/Refitting the Fridge Drawer

- 1** Lift the drawer up and remove it by pulling it out.

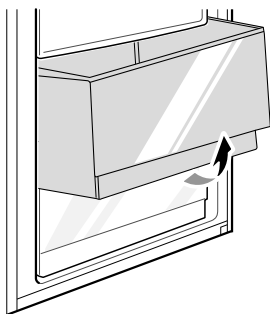

- 2** Refit the drawer in the reverse order of the removal process.

## Removing/Refitting the Snack Drawer

This feature is only available on some models.

- 1** Pull out the drawer and align the tab **1** with the hole **2**. Lift up the front of the drawer and straight it out.

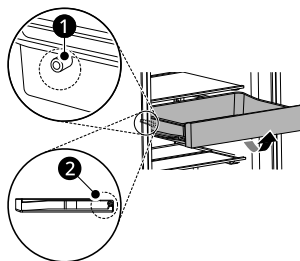

- 2** Tilt the drawer and remove it by pulling it out.

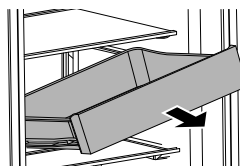

- 3** Mount it in the reverse order of the removal process.

## Using the Fresh Balancer

This feature is only available on some models. Store fruits and vegetables fresh. Adjust the controller **1** to meet individual storage needs.

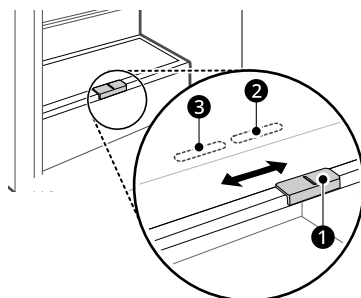

- 2** For storing vegetables. (Recommended)

- 3 For storing fruit.

### Door Basket

#### Removing/Refitting the Door Basket

- 1 Hold both edges of the basket and remove it by lifting it upward.

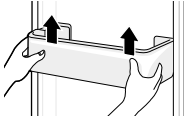

- 2 Refit the door basket in the reverse order of the removal process.

### Shelf

#### Removing/Refitting the Shelf

- 1 Hold the both side of the shelf. Lift the shelf up and pull it forward.

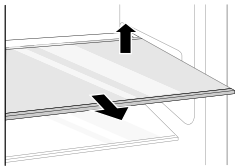

- 2 Tilt the shelf and remove it by pulling it out.

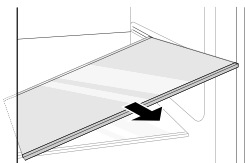

- 3 Refit the shelf by sliding it inward until the shelf snaps into the frame.

### Using Folding Shelf

This feature is only available on some models. Store taller items, such as a gallon container or bottles, by pushing the front half of the shelf underneath the back half the shelf.

- Pull the front of the shelf forward to return to a full shelf.

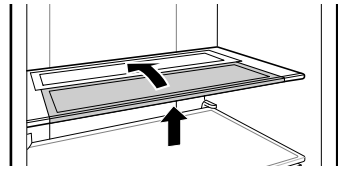

### Bottle Rack

#### Removing/Refitting the Rack

This feature is only available on some models.

- 1 Hold the both side of the rack. Lift the rack up and pull it forward.

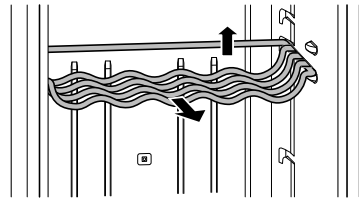

- 2 Tilt the rack and remove it by pulling it out.

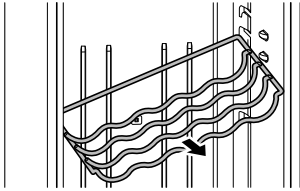

- 3 Refit the rack by sliding it inward until the rack snaps into the frame.

## SMART FUNCTIONS

### LG ThinQ Application

This feature is only available on models with Wi-Fi. The **LG ThinQ** application allows you to communicate with the appliance using a smartphone.

### LG ThinQ Application Features

Communicate with the appliance from a smartphone using the convenient smart features.

#### Smart Diagnosis

- If you experience a problem while using the appliance, this smart diagnosis feature will help you diagnose the problem.

#### Settings

- Allows you to set various options on the appliance and in the application.

### NOTE

- If you change your wireless router, internet service provider, or password, delete the registered appliance from the **LG ThinQ** application and register it again.
- The application is subject to change for appliance improvement purposes without notice to users.
- Functions may vary by model.

### Installing LG ThinQ Application and Connecting an LG Appliance

#### Models with QR Code

Scan the QR code attached to the product using the camera or a QR code reader application on your smartphone.

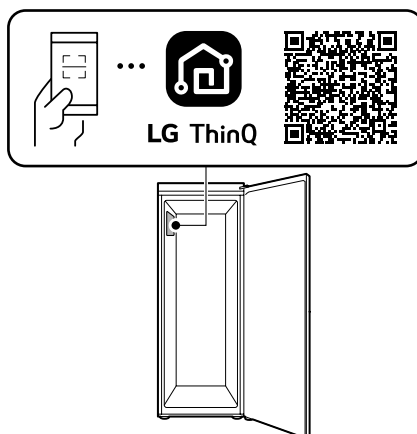

#### Models without QR Code

- 1 Search for and install the **LG ThinQ** application from the Google Play Store or Apple App Store on a smartphone.
- 2 Run the **LG ThinQ** application and sign in with your existing account or create an LG account to sign in.
- 3 Touch the add (+) button on the **LG ThinQ** application to connect your LG appliance. Follow the instructions in the application to complete the process.

**NOTE**

- To verify the Wi-Fi connection, check that the Wi-Fi indicator on the control panel is lit.
- The appliance supports 2.4 GHz Wi-Fi networks only. To check your network frequency, contact your Internet service provider or refer to your wireless router manual.
- **LG ThinQ** is not responsible for any network connection problems or any faults, malfunctions, or errors caused by network connection.
- The surrounding wireless environment can make the wireless network service run slowly.
- If the distance between the appliance and the wireless router is too far, the signal strength becomes weak. It may take a long time to connect or installation may fail.
- If the appliance is having trouble connecting to the Wi-Fi network, it may be too far from the router. Purchase a Wi-Fi repeater (range extender) to improve the Wi-Fi signal strength.
- The network connection may not work properly depending on the Internet service provider.
- The Wi-Fi connection may not connect or may be interrupted because of the home network environment.
- The appliance cannot be connected due to problems with the wireless signal transmission. Unplug the appliance and wait about a minute before trying again.
- If the firewall on your wireless router is enabled, disable the firewall or add an exception to it.
- The wireless network name (SSID) should be a combination of English letters and numbers. (Do not use special characters.)
- Smartphone user interface (UI) may vary depending on the mobile operating system (OS) and the manufacturer.
- If the security protocol of the router is set to **WEP**, you may fail to set up the network. Please change it to other security protocols (**WPA2** is recommended) and connect the product again.
- To disable the Wi-Fi function, press and hold the **Wi-Fi** button for 3 seconds. The Wi-Fi indicator will be turned off.

- To reconnect the appliance or add another user, press and hold the **Wi-Fi** button for 3 seconds to temporarily turn it off. Run the **LG ThinQ** application and follow the instructions in the application to connect the appliance.

## RF Radiation Exposure Statement

This equipment shall be installed and used at a minimum distance of 20 cm from the human body.

## Open Source Software Notice Information

To obtain the source code that is contained in this product, under GPL, LGPL, MPL, and other open source licenses that have the obligation to disclose source code, and to access all referred license terms, copyright notices and other relevant documents, please visit <https://opensource.lge.com>.

LG Electronics will also provide open source code to you on CD-ROM for a charge covering the cost of performing such distribution (such as the cost of media, shipping, and handling) upon email request to [opensource@lge.com](mailto:opensource@lge.com).

This offer is valid to anyone in receipt of this information for a period of three years after our last shipment of this product.

## Smart Diagnosis

Use this feature to help you diagnose and solve problems with your appliance.

**NOTE**

- For reasons not attributable to LGE's negligence, the service may not operate due to external factors such as, but not limited to, Wi-Fi unavailability, Wi-Fi disconnection, local app store policy, or app unavailability.
- The feature may be subject to change without prior notice and may have a different form depending on where you are located.

### Using LG ThinQ to Diagnose Issues

If you experience a problem with your Wi-Fi equipped appliance, it can transmit troubleshooting data to a smartphone using the **LG ThinQ** application.

- Launch the **LG ThinQ** application and select the **Smart Diagnosis** feature in the menu. Follow the instructions provided in the **LG ThinQ** application.

### Using Audible Diagnosis to Diagnose Issues

\*1 This control panel is only available on some models.

Follow the instructions below to use the audible diagnosis method.

- Launch the **LG ThinQ** application and select the **Smart Diagnosis** feature in the menu. Follow the instructions for audible diagnosis provided in the **LG ThinQ** application.

#### Control Panel 1: On the Fridge Door\*1

- 1** Press the **Lock** button to activate the lock function.
  - If the display has been locked for over 5 minutes, you must deactivate the lock and then reactivate it.
- 2** Press and hold the **Fridge** button for three seconds or longer.
- 3** Open the door and then hold the phone near the speaker hole.

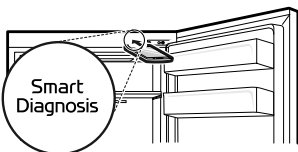

- 4** After the data transfer is complete, the diagnosis will be displayed in the application.

#### Control Panel 2: Inside the Fridge\*1

- 1** Open the fridge door.
- 2** Press and hold the **Fridge** button for 3 seconds or longer.
- 3** Hold the phone near the speaker hole.

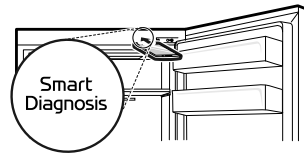

- 4** After the data transfer is complete, the diagnosis will be displayed in the application.

---

#### NOTE

- For best results, do not move the phone while the tones are being transmitted.
-

# MAINTENANCE

## Cleaning

### General Cleaning Tips

- When cleaning the inside or outside of the appliance, do not wipe it with a rough brush, toothpaste, or abrasive pads. Do not use any chemical cleaners that contain or are blended with solvents or flammable substances or caustic based detergents. These include but are not limited to:
  - Flammable substances: alcohol (ethanol, methanol, isopropyl alcohol, isobutyl alcohol, etc.), thinner, bleach, benzene, flammable liquid, abrasive, etc.
  - This may cause discoloration or damage to the appliance's internal parts and wall lining.
- After cleaning, check if the power cable is damaged.

### Cleaning the Exterior

- The outside air vents and rear lower cover should be cleaned periodically to remove dust build up. Failure to do so could cause the appliance to lose its cooling ability and cause the compressor to overheat and malfunction resulting in food loss.
- When cleaning the side vents and rear lower cover by vacuuming, then the power cord must be unplugged from the outlet to avoid any static discharge that can damage the electronics or cause an electric shock. Regular cleaning of the rear and side ventilation covers is also necessary to maintain reliable and economical operation of the unit.
- Failure to keep the air vents on the exterior of the appliance clean can also cause overheating, appliance damage or property damage if the defrosted water cannot evaporate from the rear drain pan.
- For the appliance exterior, use a clean sponge or soft cloth and a mild detergent in warm water. Do not use abrasive or harsh cleaners. Dry thoroughly with a soft dedicated cloth. Do not use contaminated cloths when cleaning the

stainless steel doors. Always use a dedicated cloth and wipe in the same direction as the grain. This helps reduce surface staining and tarnishing.

### Cleaning the Interior

- When removing a shelf or drawer from inside the appliance, remove all stored foods from the shelf or drawer to prevent injury or damage to the appliance. Otherwise, injury may occur due to the weight of stored foods.
- Detach the shelves and drawers and clean them with water, and then dry them sufficiently, before replacing them.
- Regularly wipe the door gaskets with a wet soft towel.
- Door basket spills and stains should be cleaned as they can compromise storage ability of the basket and could even be damaged.
- Never clean the shelves or containers in the dishwasher. The parts may become deformed due to the heat.

### Air Filter

#### Reusing the Air Filter

You can remove the odors absorbed by the Air Filter and reuse it.

## 28 MAINTENANCE

---

- 1 Pull out the drawer in the on the bottom compartment.

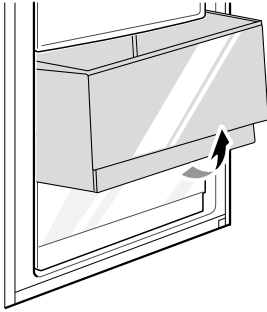

you and can be wiped off easily with a towel or cloth.

- 2 Press on the hook inside the top compartment, and then take out the Air Filter.

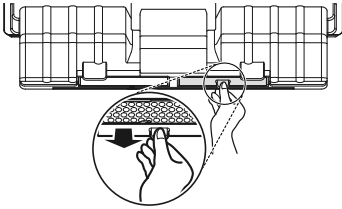

- 3 Dry it using a hair dryer or by exposing it to sunlight. The filter is reusable.

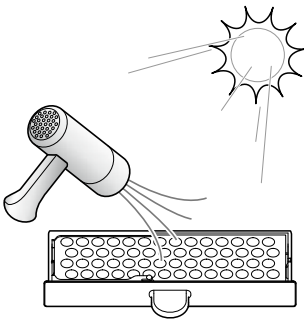

- To increase deodorizing performance, a natural palm wood material is attached to the filter. If residue falls off, it will not harm

# TROUBLESHOOTING

## Before Calling for Service

### Cooling

Symptoms	Possible Cause & Solution
There is no refrigeration.	<b>Is there a power interruption?</b> <ul style="list-style-type: none"> <li>Check the power of other appliances.</li> </ul>
	<b>Appliance is unplugged.</b> <ul style="list-style-type: none"> <li>Plug the power plug in the outlet properly.</li> </ul>
	<b>A fuse in your home may be blown or the circuit breaker tripped. Or the appliance is connected to a GFCI (Ground Fault Circuit Interrupter) outlet, and the outlet's circuit breaker has tripped.</b> <ul style="list-style-type: none"> <li>Check the main electrical box and replace the fuse or reset the circuit breaker. Do not increase fuse capacity. If the problem is a circuit overload, have it corrected by a qualified electrician.</li> <li>Reset the circuit breaker on the GFCI. If the problem persists, contact an electrician.</li> </ul>
There is poor refrigeration.	<b>Is the fridge temperature set to its from 6 °C to 8 °C setting?</b> <ul style="list-style-type: none"> <li>Set the fridge temperature to 4 °C.</li> </ul>
	<b>Is the appliance in direct sunlight, or is it near a heat generating object such as cooking oven or heater?</b> <ul style="list-style-type: none"> <li>Check the installation area and reinstall it away from heat generating objects.</li> </ul>
	<b>Did you store hot food without cooling it first?</b> <ul style="list-style-type: none"> <li>Cool the hot food first before putting it in the fridge compartment.</li> </ul>
	<b>Did you put in too much food?</b> <ul style="list-style-type: none"> <li>Maintain an appropriate space between food.</li> </ul>
	<b>Are the appliance doors completely closed?</b> <ul style="list-style-type: none"> <li>Completely close the door and make sure that stored food is not obstructing in the door.</li> </ul>
	<b>Is there enough space around the appliance?</b> <ul style="list-style-type: none"> <li>Adjust the installation position to make enough space around the appliance.</li> </ul>
The appliance contains a bad smell.	<b>Did you put in food with a strong smell?</b> <ul style="list-style-type: none"> <li>Store foods with strong smells in sealed containers.</li> </ul>

Symptoms	Possible Cause & Solution
The appliance smells of wood burning.	<p><b>Special heat treatments have been carried out to compensate for the weak points of moisture-affected wood and to prevent pest damage.</b></p> <ul style="list-style-type: none"> <li>The special heat treatment process can smell of the wood burning, but rest assured that it will disappear naturally after a certain period of time.</li> </ul>

## Condensation & Frost

Symptoms	Possible Cause & Solution
There is condensation inside the appliance.	<p><b>Did you store hot food without cooling it first?</b></p> <ul style="list-style-type: none"> <li>Cool the hot food first before putting it inside the fridge.</li> </ul>
	<p><b>Did you leave the appliance door open?</b></p> <ul style="list-style-type: none"> <li>Although the condensation will disappear soon after you close the appliance door, you can wipe it with a dry cloth.</li> </ul>
	<p><b>Do you open and close the appliance door too frequently?</b></p> <ul style="list-style-type: none"> <li>Condensation can form due to the temperature difference from the outside. Wipe out the dampness with a dry cloth.</li> </ul>
	<p><b>Did you put warm or moist food inside without sealing it in a container?</b></p> <ul style="list-style-type: none"> <li>Store food in a covered or sealed container.</li> </ul>
Condensation has formed inside or outside the appliance.	<p><b>Did you open and close the appliance door frequently or is the appliance door improperly closed?</b></p> <ul style="list-style-type: none"> <li>Condensation can form if the outside air penetrates inside the appliance.</li> </ul>
	<p><b>Is the installation environment humid?</b></p> <ul style="list-style-type: none"> <li>Condensation can appear on the exterior of the appliance if the installation area is too humid or on a humid day such as a rainy day. Wipe off any moisture with a dry cloth.</li> </ul>
The front or behind of the appliance is warm.	<p><b>There are anti condensation pipes and a ventilation fan fitted to these areas of the appliance to reduce condensation forming from around the door area.</b></p> <ul style="list-style-type: none"> <li>The heat releasing pipe and the ventilation fan to prevent condensation are installed on the front and behind of the appliance. You may feel it particularly hot right after the appliance is installed or during the summer. You can be assured that this is not a problem and is quite normal.</li> <li>This is radiated heat through the bottom front (mood light) of the appliance. Hot air may be felt, but it is not a malfunction.</li> </ul>
There is water inside or outside of the appliance.	<p><b>Is there water leakage around the appliance?</b></p> <ul style="list-style-type: none"> <li>Check if the water has leaked from a sink or another place.</li> </ul>
	<p><b>Is there water on the bottom of the appliance?</b></p> <ul style="list-style-type: none"> <li>Check if water leaks because water spills or the container breaks or falls.</li> </ul>

Symptoms	Possible Cause & Solution
There is water inside or outside of the appliance.	<b>Is there water leakage around the appliance?</b> <ul style="list-style-type: none"> <li>Check if the water has leaked from a sink or another place.</li> </ul>
	<b>Is there water on the bottom of the appliance?</b> <ul style="list-style-type: none"> <li>Check if the water is from the thawed frozen food or a broken or dropped container.</li> </ul>

## Parts & Features

Symptoms	Possible Cause & Solution
The inside lamp in the appliance does not turn on.	<b>Lamp failure</b> <ul style="list-style-type: none"> <li>Close the door and re-open. If the lamp does not turn on, please contact the LG Electronics customer information centre. Do not attempt removal of the lamp.</li> </ul>
The appliance door is not closed tightly.	<b>Is the appliance leaning forward?</b> <ul style="list-style-type: none"> <li>Adjust the front feet to raise the front side slightly.</li> </ul>
	<b>Were the shelves properly assembled?</b> <ul style="list-style-type: none"> <li>Refit the shelves if needed.</li> </ul>
	<b>Did you close the door with excessive force?</b> <ul style="list-style-type: none"> <li>If you apply too much force or speed when closing the door, it may remain briefly open before closing. Make sure that you do not slam the door closed. Close the door gently.</li> </ul>
It is difficult to open the appliance door.	<b>Did you open the door right after you closed it?</b> <ul style="list-style-type: none"> <li>If you try to open the appliance door within one minute after you closed it, you may have difficulties because of the pressure inside the appliance. Try to open the appliance door again in a few minutes so that the internal pressure stabilizes.</li> </ul>

## Noises

Symptoms	Possible Cause & Solution
The appliance is noisy and generates abnormal sounds.	<b>Is the appliance installed on a weak floor or improperly levelled?</b> <ul style="list-style-type: none"> <li>Install the appliance on a solid and flat area.</li> </ul>
	<b>Does the rear of the appliance touch the wall?</b> <ul style="list-style-type: none"> <li>Adjust the installation position to allow enough clearance around the appliance.</li> </ul>

Symptoms	Possible Cause & Solution
The appliance is noisy and generates abnormal sounds.	<b>Are objects scattered behind the appliance?</b> <ul style="list-style-type: none"> <li>Remove the scattered objects from behind the appliance.</li> </ul>
	<b>Is there an object on top of the appliance?</b> <ul style="list-style-type: none"> <li>Remove the object on top of the appliance.</li> </ul>
Rattling noises	<b>Appliance is not resting evenly on the floor.</b> <ul style="list-style-type: none"> <li>Floor is weak or uneven or levelling legs need to be adjusted.</li> </ul>
Popping noises	<b>Contraction and expansion of the inside walls due to changes in temperature.</b> <ul style="list-style-type: none"> <li>Normal Operation</li> </ul>
Vibrating	<b>If the side or back of the appliance is touching a cabinet or wall, some of the normal vibrations may make an audible sound.</b> <ul style="list-style-type: none"> <li>To eliminate the noise, make sure that the sides and back do not make any contact with any wall or cabinet.</li> </ul>

## Wi-Fi

Symptoms	Possible Cause & Solution
Your home appliance and smartphone are not connected to the Wi-Fi network.	<b>The password for the Wi-Fi that you are trying to connect to is incorrect.</b> <ul style="list-style-type: none"> <li>Find the Wi-Fi network connected to your smartphone and remove it, then register your appliance on <b>LG ThinQ</b>.</li> </ul>
	<b>Mobile data for your smartphone is turned on.</b> <ul style="list-style-type: none"> <li>Turn off the <b>Mobile data</b> of your smartphone and register the appliance using the Wi-Fi network.</li> </ul>
	<b>The wireless network name (SSID) is set incorrectly.</b> <ul style="list-style-type: none"> <li>The wireless network name (SSID) should be a combination of English letters and numbers. (Do not use special characters.)</li> </ul>
	<b>The router frequency is not 2.4 GHz.</b> <ul style="list-style-type: none"> <li>Only a 2.4 GHz router frequency is supported. Set the wireless router to 2.4 GHz and connect the appliance to the wireless router. To check the router frequency, check with your Internet service provider or the router manufacturer.</li> </ul>
	<b>The distance between the appliance and the router is too far.</b> <ul style="list-style-type: none"> <li>If the distance between the appliance and the router is too far, the signal may be weak and the connection may not be configured correctly. Move the location of the router so that it is closer to the appliance.</li> </ul>

**Memo**

**Memo**

**Memo**

