



OWNER'S MANUAL

LG TONE Free

Bluetooth® LG Stereo Headset

For user safety and convenience, please read the user manual before using the product.

Model

TONE-T90Q

Quick Guide

Using Easily in Order

1. Connecting the smartphone to earbuds with Bluetooth (→ Please refer to “Connecting the Smartphone to Earbuds via Bluetooth” on page 9.)

- 1 Press the settings app [⚙️] of the smartphone. Then select Bluetooth and turn on the Bluetooth function. (Off > On)
- 2 Open the cover with earbuds attached to the charging case. The blue battery status indicator on the front blinks. If the blue battery status indicator does not blink, or if you want to connect a device other than the one already connected, touch and hold the touch pad of the left or right earbud for 3 - 5 seconds.

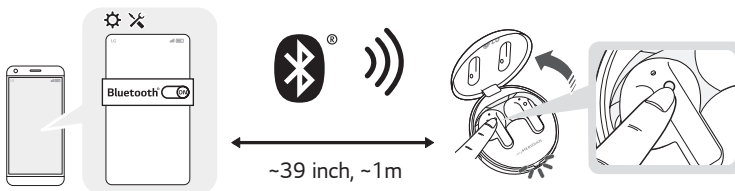



- 3 When the Fast Pair connection pop-up appears at the bottom of the smartphone screen, touch the pop-up to connect.
- 4 If the connection pop-up does not show up, search for [TONE-T90Q] in the Bluetooth® menu of the smartphone and touch it.
 - TONE-T90Q_LE is not a valid connection model name in the Bluetooth® connection device list. Check the model name you are using and connect with the model name that does not contain “LE”.



2. Using earbuds with touch (→ Please refer to “Listening to Music”, “Receiving Phone Call” and “Listening to Ambient Sound/Active Noise Cancellation (ANC)” on pages 12, 13 and 14.)

You can touch the earbuds to play or pause music, or receive or reject a phone call. You can change how the function operates in the touch pad settings of the LG TONE Free app.



Receiving phone call

How to Use	Call
 Touch once	Receiving calls
 Touch twice	Hanging up calls
 Touch and hold	Rejecting calls

Listening to music

How to use	Play
 Touch once	Play/Pause
 Touch twice	Decrease volume (left touch) Increase volume (right touch)
 Touch three times	Next song

Connecting to an external device for use (Plug and Wireless mode)

How to Use	Plug and Wireless mode
 Touch once	Mute or unmute
 Touch twice	Decrease volume (left touch) Increase volume (right touch)
 Touch three times	Play the next song (Connecting with USB audio device)

- If you connect the charging case to an analog device, the touch three times function does not operate.
- Connect the charging case to a USB audio device and then touch once to play/pause music.

Listening to ambient sound/Active noise cancellation (ANC)

How to Use	Listening to ambient sound/Active noise cancellation (ANC)
 Touch and hold	Change function

3. Connecting to an external device for use (Plug and Wireless mode) (→ Please refer to “Connecting and Disconnecting with an Analog Device” and “Connecting and Disconnecting with a USB Audio Device” on pages 15 and 17.)

You can connect the charging case to an analog device (airplane seat audio, treadmill, cassette, radio, TV, etc.) or a USB audio device (PC) to listen to the sound with the earbuds.

How to connect an analog device

- 1 Connect the USB-C™ port of the included USB-C™ to AUX cable to the charging case.
- 2 Connect the AUX terminal to a desired device.
- 3 Wear earbuds on your ears.
- 4 Slide the Plug and Wireless mode switch to the right to turn on the mode. The indicator on the charging case blinks green.
- 5 When the charging case and earbuds are connected, the indicator turns off.

* To disconnect the external device, slide the Plug and Wireless mode switch to the left. The indicator on the charging case blinks blue and the device is reconnected to the device that has been previously connected.

* If you cannot find a device which has been previously connected, it enters the Connectable mode.

* When connected to an analog device, the call function is not supported.

How to connect a USB audio device

- 1 Connect the USB-C terminal of the included USB Type-C™ Charging and Data cable to the charging case.
- 2 Connect the USB-A terminal to a desired device.
- 3 Wear earbuds on your ears.
- 4 Slide the Plug and Wireless mode switch to the right to turn on the mode. The indicator on the charging case blinks green.
- 5 Once the charging case is connected to the earbuds, the green indicator turns off and the case charging status is displayed.

* To disconnect the external device, slide the Plug and Wireless mode switch to the left. The indicator on the charging case blinks blue and the device is reconnected to the device that has been previously connected.

* If you cannot find a device which has been previously connected, it enters the Connectable mode.

4. Charging (→ Please refer to “Charging by Wire”, “Charging Wirelessly” and “Description on UVnano” on pages 19, and 20.)

Wired charging

Connect the charging cable to charge the charging case with earbuds. The earbuds and charging case are charged at the same time.

- If you charge the device with the earbuds attached and the cover closed, the UVnano LED operates for 10 minutes.

Wireless charging

Place the charging case on the center of the wireless charger.

- If you charge wirelessly, UVnano sterilization is performed for 10 minutes and charging starts.

⚠ Caution

- Please note that the temperature of the earbuds may become higher while the UVnano LED is operating.
-

5. Connecting the LG TONE Free app (→ Please refer to “Connecting the LG TONE Free App” on page 22.)

- 1 Search for “LG TONE Free” on Google Play Store or App Store on your smartphone or scan the QR code below to install the LG TONE Free app.
- 2 Run the app to use various functions (checking the earbuds battery, voice notification, changing the equalizer mode, checking the information on the last connected location, searching for my wireless earbuds, etc.) Only Android 7.0 or iOS 13 or higher is supported.



<Android>



<iOS>

Contents

Quick Guide

- 2 Using Easily in Order

Exploring the Product

- 7 Charging Case
- 8 Earbuds

Connecting with Bluetooth for Use

- 9 Connecting the Smartphone to Earbuds via Bluetooth
- 10 Multiple Connections
- 10 Automatic Reconnection

Listening to Sound with Earbuds

- 11 Wearing Earbuds
- 12 Listening to Music
- 13 Receiving Phone Call
- 14 Listening to Ambient Sound/Active Noise Cancellation (ANC)

Connecting to an External Device for Use (Plug and Wireless Mode)

- 15 Connecting
- 15 Connecting and Disconnecting with an Analog Device
- 17 Connecting and Disconnecting with a USB Audio Device

Charging

- 19 Charging by Wire
- 19 Charging Wirelessly
- 20 Description on UVnano
- 21 Checking Battery Status

Connecting to the Bluetooth App

- 22 Connecting the LG TONE Free App

Safety Precautions

- 23 Safety Notices and Warnings
- 24 Precautions when Using the Product

Things to Check before Reporting Malfunction

- 25 Troubleshooting

Appendix

- 26 Product Specifications

Safety Information

- 27 Prevention of Hearing Loss
- 27 Additional Information
- 27 Radio frequency exposure
- 28 Bluetooth connection precautions
- 28 Battery Information
- 29 Registered Trademarks and Licenses
- 30 Open Source Software Notice Information

Cleaning Guide

- 31 Cleaning Earbud

Exploring the Product

| Charging Case

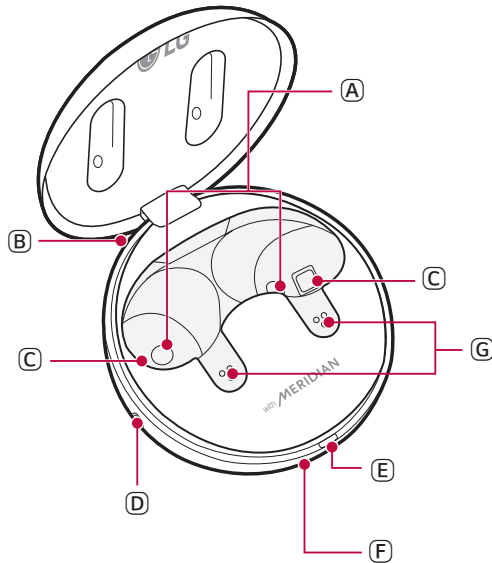

- (A) Mood light: When you open the charging case, the mood light turns on and off.
- (B) Case charging port: You can charge a device or use Plug and Wireless mode.
- (C) UVnano LED: If you charge the device with the earbuds attached and the cover closed, the UVnano LED operates for 10 minutes.
- (D) Plug and Wireless mode switch: You can connect analog and USB audio devices and the charging case to listen to the sound through the earbuds.
- (E) Battery status indicator (up): You can check the battery status of the earbuds or charging case.
- (F) UVnano indicator (down): The UVnano indicator is blue while the UVnano LED is operating.
- (G) Earbuds charging terminals: You can charge the earbuds by attaching them to the charging case.

| Earbuds

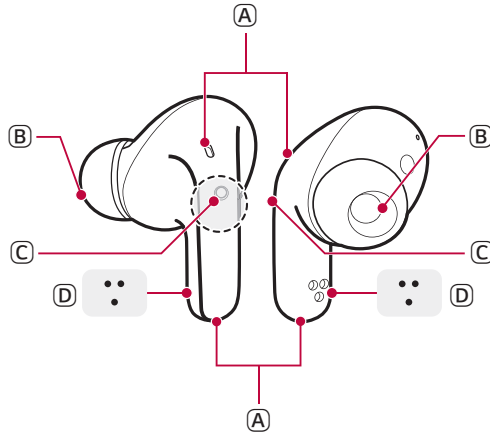

- (A) Microphone
- (B) Speaker mesh (microphone)
- (C) Touch pad
- (D) Earbuds charging terminals

✔ Note

- Be careful that foreign substances are not over the Earbuds charging terminals.
-

Connecting with Bluetooth for Use

Connecting the Smartphone to Earbuds via Bluetooth

- 1 Turn on the Bluetooth® function of your smartphone or a device you want to connect.
- 2 Open the cover with earbuds attached to the charging case. The blue battery status indicator on the front blinks. If the blue battery status indicator does not blink, or if you want to connect a device other than the one already connected, touch and hold the touch pad of the left or right earbud for 3 - 5 seconds.

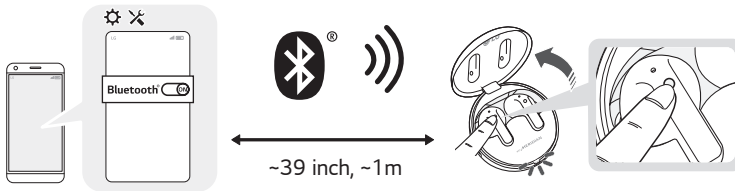

- 3 When the Fast Pair connection pop-up appears at the bottom of the smartphone screen, touch the pop-up to connect.
 - Only Android™ 6.0 or higher is supported, and Bluetooth® and location information settings of the mobile device are required.
- 4 If the connection pop-up does not show up, select and connect [TONE-T90Q] in the Bluetooth® menu of the smartphone. (For users of iOS or Android 5.0 or lower)
 - TONE-T90Q_LE is not a valid connection model name in the Bluetooth® connection device list. Check the model name you are using and connect with the model name that does not contain "LE".
 - If the earbuds model name is displayed abnormally on the Android device, please change the model name in the Bluetooth® menu of the settings of the connected device.

✓ Note

- To connect with another device, perform the above procedures again.

Multiple Connections

If you use the LG TONE Free app, you can connect and use two devices, such as a smartphone and a PC at the same time.

- 1 Please activate Multi-Point & Multi-Pairing on the LG TONE Free app.
- 2 Put the earbuds in the charging case and perform the connecting procedures in the same way.
- 3 The existing connection device becomes the "main connection device" and the newly connected device becomes the "auxiliary connection device".
- 4 You can use the multi-connection function more conveniently in the detailed Multi-Point & Multi-Pairing settings.
- 5 Of the two devices, the sound of the device with which you played the content lastly is heard. (When the charging case is connected with a USB-C™ to AUX cable in Plug&Wireless mode, it changes to the charging case sound when the "main connection device" is not playing or talking.)

✔ Note

- When the two devices are connected at the same time, the main function operates based on the "main connection device".
-

Automatic Reconnection

If you open the charging case of the earbuds, they are automatically connected to the last connected and used device. (If the device cannot be found, it changes to the connectable mode.)

If automatic reconnection is not done, search for earbuds on the device to be connected and connect them manually.

Listening to Sound with Earbuds

Wearing Earbuds

1 Remove the earbuds from the charging case and wear them to fit tightly into your ears.

✓ Note

- If you use an ear gel sized to fit your ears, you can improve performance of active noise cancellation (ANC). You can then listen to music with rich sound quality.

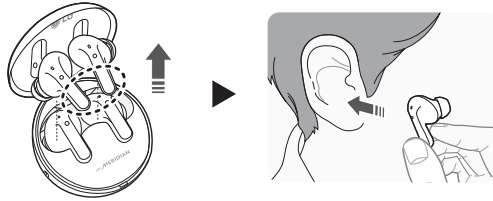

2 If you wear earbuds properly, you can hear a wear detection sound.

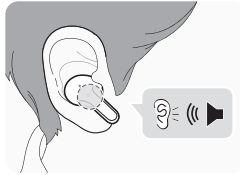

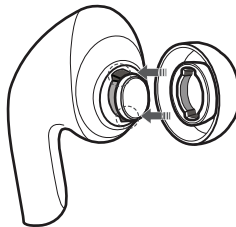

* To replace the ear gel, align the hole shape of the ear gel with the protrusion of the earbuds and fasten it.

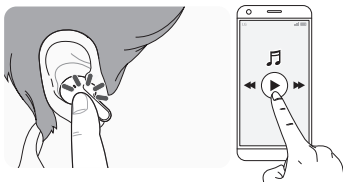

Listening to Music







Function	How to Use
Play/Pause	 : Touch the left or right earbud once.
Volume control	 : Touch the left (volume down) or right (volume up) earbud twice.
Next song	 : Touch the left or right earbud three times.

✔ Note

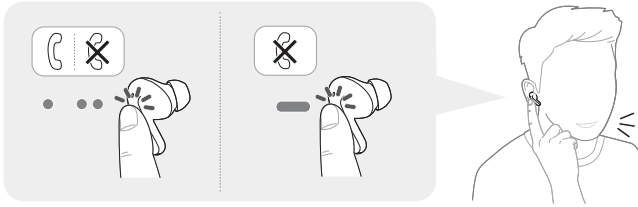
- You can change how to use the function in the touch pad settings of the LG TONE Free app.

Receiving Phone Call



Function	How to Use
Receiving calls	 : Touch the left or right earbud once.
Hanging up calls	 : Touch the left or right earbud twice.
Rejecting calls	 : Touch and hold the left or right earbud.

Smartphone call function

Function/Status	Description
Receiving calls/When receiving phone calls	Touch the left or right earbud once.
Making calls/Waiting to use	When you make a call from your smartphone, the call is automatically connected to the headset.
Receiving another call during a call/ During a call	If you touch the left or right earbud once, the current phone call is switched to the standby status and you can receive an incoming call during a call. If an existing call is on hold, you can end the current call on your smartphone. (This operates differently depending on the smartphone settings.)

Listening to Ambient Sound/Active Noise Cancellation (ANC)

Listening to ambient sound

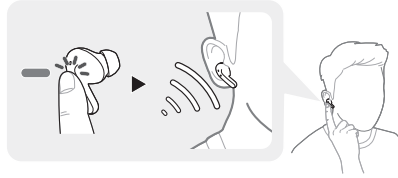

The listening to ambient sound function makes you hear outside sounds, so that you can be aware about your surroundings and hazards.

Active noise cancellation (ANC)

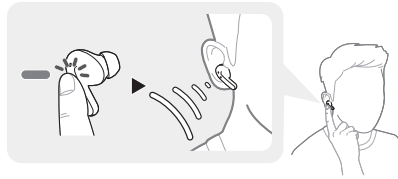

The active noise cancellation (ANC) function blocks external sounds during use. Therefore, use it when you do not want to be disturbed while listening to music or watching a video.

- **If you touch and hold the left or right earbud**, you can switch between active noise cancellation (ANC) and listening to ambient sound.
- You can set listening to ambient sound or active noise cancellation (ANC) functions in the LG TONE Free app.
- You can set listening mode and conversation mode in the LG TONE Free app.
- When using listening to ambient sound function or active noise cancellation (ANC) function, the available time is shorter than while it is turned off.
- The listening to ambient sound or active noise cancellation (ANC) function operates when you are in standby/ listening to music/during a call.
 - ANC stands for active noise cancellation.



⚠ Caution

- When the ambient sound mode is executed, you may hear a loud ambient sound suddenly. Pay attention to safety when using active noise cancellation (ANC) outdoors.
-

Connecting to an External Device for Use (Plug and Wireless Mode)

Connecting

You can connect the charging case to an analog device such as audio in airplane seat, treadmill, cassette, radio, TV or a USB audio device such as PC to listen to the sound with an earbuds.

Function	How to Use
Mute or unmute	 : Touch the left or right earbud once.
Decrease volume (left touch) Increase volume (right touch)	 : Touch the left or right earbud twice.
Play the next song	 : Touch the left or right earbud three times. (Connecting with USB audio device)

- If you connect the charging case to an analog device, the touch three times function does not operate.
- Connect the charging case to a USB audio device and then touch once to play/pause music.

Connecting and Disconnecting with an Analog Device

Connecting with an analog device

- 1 Connect the USB-C™ port of the USB-C™ to AUX cable to the charging case.
- 2 Connect the AUX terminal to a desired device.

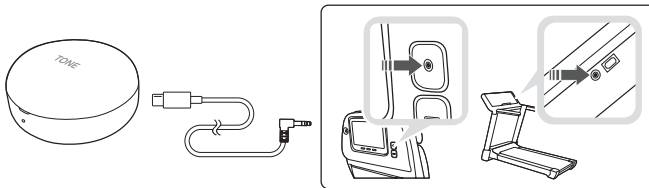

- 3 Wear earbuds on your ears.
- 4 Slide the Plug and Wireless mode switch to the right to turn on the mode.
- 5 The indicator on the charging case blinks green.
- 6 When the charging case and earbuds are connected, the indicator turns off.

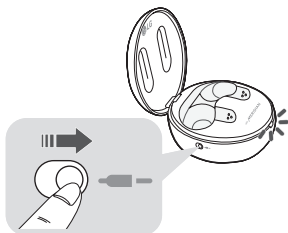

Disconnecting with an analog device

- 1 Push the Plug and Wireless mode switch to the left.
- 2 The indicator on the charging case blinks blue.
- 3 When disconnected, it is reconnected with the device with which has been previously connected.
 - If you cannot find a device which has been previously connected, it enters the Connectable mode.

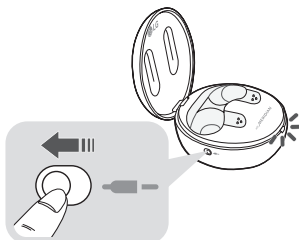

✓ Note

- The LG TONE Free app cannot be used, and the EQ or touch pad settings are retained.
 - It does not support the call function.
 - The USB-C™ to AUX cable does not support the charging function.
 - The product may not be compatible with some devices, and certain airplane seats may require a conversion adapter (sold separately).
 - If you use the product for a long time, the use time (including the charging case) may be shorter than when connecting and using a smartphone.
-

Connecting and Disconnecting with a USB Audio Device

Connecting with a USB audio device

- 1 Connect the USB-C terminal of the included USB Type-C™ Charging and Data cable to the charging case.
- 2 Connect the USB-A terminal to a desired device.

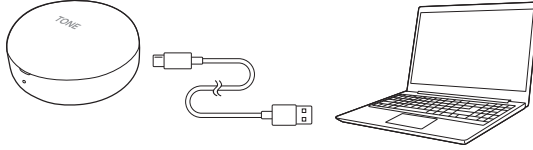

- 3 Wear earbuds on your ears.
- 4 Slide the Plug and Wireless mode switch to the right to turn on the mode.
- 5 The indicator on the charging case blinks green.
- 6 Once the charging case is connected to the earbuds, the green indicator turns off and the case charging status is displayed.

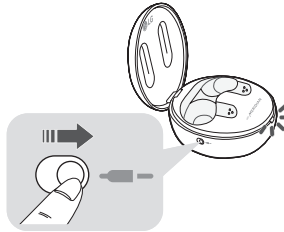

Disconnecting with a USB audio device

- ❶ Push the Plug and Wireless mode switch to the left.
- ❷ The indicator on the charging case blinks blue.
- ❸ When disconnected, it is reconnected with the device with which has been previously connected.
 - If you cannot find a device which has been previously connected, it enters the Connectable mode.

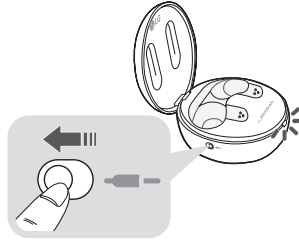

✔ Note

- When connected with a USB audio, it supports the call function and is displayed as TONE-T90QC on the USB audio device.
 - If you use the product for a long time, the use time (including the charging case) may be shorter than when connecting and using a smartphone.
-

Charging

| Charging by Wire

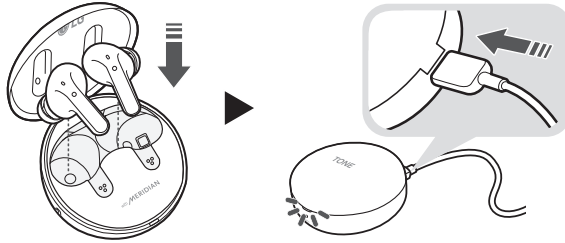

If you connect the charging cable, the charging status shows up on the charging case.

✔ Note

- The earbuds and charging case are charged at the same time.
- The Case charging port of the charging case does not support the power supply function to other devices such as smartphone.

| Charging Wirelessly

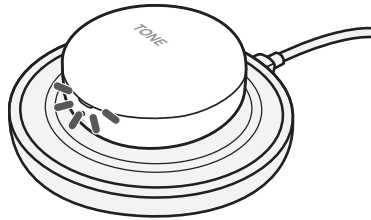

Place the charging case on the center of the wireless charger.

✔ Note

- A wireless charger is not provided.
- For some wireless chargers, the wireless charging function may not operate.
- For wireless charging, it takes a long to charge.
- If you charge wirelessly, UVnano sterilization is performed for 10 minutes and charging starts.

Description on UVnano

The charging case has a built-in UVnano LED to keep the earbuds clean.

If you charge the device with the earbuds attached and the cover closed, the UVnano LED operates for 10 minutes.

* UVnano is a compound word of UV and nanometer, the unit of UV.



✔ Note

- The UVnano indicator is blue while the UVnano LED is in operation.
- The UVnano charging case removes up to 99.9% of harmful germs from ear gel.
- The white product may have a different color on the UVnano LED contact part, but there is no problem with performance.

⚠ Caution

- Please note that the temperature of the earbuds may become higher while the UVnano LED is operating.
-

Checking Battery Status

If you open the charging case, the battery status of the earbuds is displayed.

When the earbuds are not attached, the battery status of the charging case is displayed.

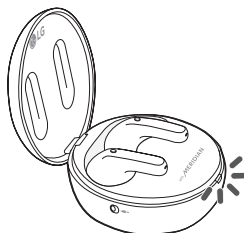

Battery status indicator	Battery level state (charger not connected) / Charging status (charger connected)
Red	20% or less / Charging
Yellow	20% ~ 80% / -
Green	80% or higher / Fully charged

Note

- If you close the charging case, the battery status of the charging case is displayed.
- When the battery in the charging case is completely consumed, the earbuds cannot be turned on or off. Please charge the charging case.

Battery status indicator

Status	Operation
Bluetooth® search mode	The blue battery status indicator blinks.
Battery 20% or less	The red battery status indicator turns on and off.
Battery 20% ~ 80%	The yellow battery status indicator turns on and off.
Battery 80% or higher	The green battery status indicator turns on and off.
When a charging error occurs	The red battery status indicator blinks.
While battery is charged (charger connected)	The red battery status indicator turns on.
Battery charging completed (charger connected)	The green battery status indicator turns on.

Connecting to the Bluetooth App

Connecting the LG TONE Free App

- 1 Search for “LG TONE Free” on Google Play Store or App Store on your smartphone or scan the QR code below to install the LG TONE Free app.
- 2 Run the app to use various functions (checking the earbuds battery, voice notification, changing the equalizer mode, checking the information on the last connected location, searching for my wireless earbuds, etc.) Only Android 7.0 or iOS 13 or higher is supported.



<Android>



<iOS>

Safety Precautions

| Safety Notices and Warnings

The following "Safety Precautions" are to prevent unexpected dangers or damages, so be sure to read them thoroughly.

'Safety Precautions' are divided into 'Warning' and 'Caution'

⚠ WARNING: Failure to follow the instructions may result in serious injury or death.

⚠ Caution: Failure to follow the instructions may result in minor injury or product damage.

⚠ Warning

- Do not drop the product from a high place.
 - Make sure there is no alcohol, or benzene in contact with the product.
 - Do not store the product in a wet or dusty place.
 - Do not place heavy objects on the product.
 - Earbuds tested under controlled laboratory conditions with an IPX4 rating. Resistant to splashed water: Dry before using. Do not charge while wet. Case has not been tested for IPX4.
-

⚠ Caution

- Do not disassemble, adjust, or repair the product.
 - Do not place the product near excessive heat or flammable material.
 - The product may be damaged if an incompatible charger is used.
 - Keep small components of the product away from infants or children.
 - Make sure that foreign objects do not enter the charger's connectors (Case charging port and power plug). Foreign objects in the charger's connectors may result in fire or electric shock.
 - If you have a medical device implanted, contact your doctor before using this device.
 - For your safety, do not remove the battery incorporated in the product.
 - This product has a built-in battery, and the battery cannot be removed or replaced.
 - If you arbitrarily replace the battery or don't replace it correctly, it may explode.
 - The lithium-ion battery is a hazardous component that can cause injury.
 - Battery replacement by an unqualified professional can cause damage to your device.
 - Do not discard the battery arbitrarily. Follow the local procedure for discarding batteries.
 - In order to prevent unnecessary energy consumption, disconnect the device when fully charged. Always use an easily accessible power outlet for charging your device.
 - Risk of fire or explosion if the battery is replaced by an incorrect type.
 - Do not store or transport at pressures lower than 0.116 bar (11.6 kPa) and at above 9.32 miles (15,000 m) altitude.
-

⚠ Caution

- Replacement of a battery with an incorrect type that can defeat a safeguard (for example, in the case of some lithium battery types).
 - Disposal of a battery into fire or a hot oven, or mechanically crushing or cutting of a battery, may result in an explosion.
 - Leaving a battery in an extremely high temperature surrounding environment that can result in an explosion or the leakage of flammable liquid or gas.
 - A battery subjected to extremely low air pressure may result in an explosion or the leakage of flammable liquid or gas.
 - Do not carelessly throw away old batteries. It can cause an explosion or fire. The disposal method may vary by country and region. Dispose of it in an appropriate manner.
-

| Precautions when Using the Product

Wipe the product clean if it has been exposed to a lot of sweat.

Keep the area around the earphones clean.

If you wear earphones for a long time, it may cause pain, and if the moisture in the ears remains long, it may cause skin trouble.

Things to Check before Reporting Malfunction

▮ Troubleshooting



If you experience the following symptoms while using the product, please check them again. They may not be malfunctions.

Symptom	Cause and Solution
If the power does not turn on	<ul style="list-style-type: none">• Check the battery level and charge it.
If a call cannot be made with the earbuds	<ul style="list-style-type: none">• If your smartphone does not support the hands-free function, you cannot use the call function.• Check the battery level and charge it.
If you cannot register the earbuds into the smartphone	<ul style="list-style-type: none">• Check whether power is turned on by opening the cover of the charging case.• Check that the earbuds are switched to search mode.<ul style="list-style-type: none">- If you touch and hold the touchpad on the left or right side of the earbuds for 3 to 5 seconds with the earbuds in the charging case, it is switched to search mode.• Check whether Plug and Wireless mode switch is turned on.
If you have replaced the earbuds or have problems with operation (factory reset).	<ul style="list-style-type: none">• Touch and hold the left or right touchpad of the earbuds for more than 10 seconds with the earbuds in the charging case.<ul style="list-style-type: none">- The battery status indicator of the charging case blinks red and the factory reset progresses. Please reconnect the earbuds after factory reset.

*You cannot use the factory reset and discovery mode in Plug and Wireless mode.

Appendix

Product Specifications

General	Description
Bluetooth Specifications	V 5.3 (HSP/HFP/A2DP/AVRCP)
Battery	Earbud: 3.85 V / 51 mAh, Lithium-ion Charging case: 3.7 V / 390 mAh, Lithium-ion
Music Play Time Earbuds & With Charging case	ANC Off: Up to 9 & Up to 29 hours* ANC On: Up to 5 & Up to 16 hours*
Charging Time	Earbud: within an hour / Charging case: within 2 hours Fast Charging: 5 min charge for up to 60 min playtime* <ul style="list-style-type: none">• When charging wired at room temperature
Rated Input Voltage	Earbud: 5 V  , 102 mA Charging case: 5 V  , 500 mA

*The use time may vary depending on the connected smartphone or use functions, settings, signal strength, operation temperature, using frequency band, and other use methods.

Operating Temperature	0°C (+32°F) ~ +40°C (+104°F)
Operating Humidity	5 % ~ 60 %
Dimensions (inch) / Weight (oz)	Earbud : 0.84" (W) X 1.09" (L) X 0.98" (H) / 0.19 oz (One earbud) Charging case : 2.15" (W) X 2.15" (L) X 1.16" (H) / 1.39 oz
Frequency range	2402 MHz to 2480 MHz

*Duration of use may vary depending on the connected mobile device, features being used, settings, signal strength, operating temperature, frequency band, and other methods of use.

This device was tested in compliance with FCC and ISED RF Exposure limit. (0 mm distance from human head/body (limit 1.6 W/kg @ 1g SAR) and extremity (limit 4.0 W/kg @ 10g SAR)).

This device contains licence-exempt transmitter(s)/receiver(s) that comply with Innovation, Science and Economic Development Canada's licence exempt RSS(s).

Safety Information

Prevention of Hearing Loss



If the volume of the headset is too high, you can experience permanent hearing loss. Set the volume to a safe level. It may sound normal, but if you often listen to high-pitch sounds that can damage your hearing, your ears get used to it over time.

If you feel ringing in your ears or hear faint voice, stop listening and get a hearing test. The louder the volume, the faster your hearing can be damaged.

Experts suggest you to do the followings to protect your hearing.

- Limit the time for using the headset with the high volume.
- Avoid the habit to turn up the volume not to hear loud noises around you.
- If you cannot hear people nearby, turn the volume down.

For how to set the maximum volume limit of the connection device, refer to the user manual provided with the connection device.

Additional Information

Bluetooth® letter trademark and logo are registered trademarks owned by Bluetooth SIG, Inc. The use of all trademarks is subject to license agreement.

Logos of Android, Google Play, and Google Play, and other related marks and logos are trademarks of Google LLC.



Radio frequency exposure

This Bluetooth LG Stereo Headset is a radio transmitter and receiver. When in operation, it communicates with a Bluetooth-equipped mobile device by receiving and transmitting radio frequency (RF) electromagnetic fields (microwaves) in the frequency range 2402 to 2480 MHz.

Your Bluetooth headset is designed to operate in compliance with the RF exposure guidelines and limits set by national authorities and international health agencies when used with any compatible mobile phone.

Bluetooth connection precautions

The following environments affect the range and reception of Bluetooth signals:

- When walls, metal, human bodies, or other obstacles exist between the Bluetooth device and the connected device.
- When equipment that uses 2.4 GHz frequency signals (wireless LANs, wireless phones, microwave ovens, etc.) is placed near the devices being used.
- When using a Bluetooth device (TV, laptop, etc.) other than the mobile phone, the sound quality may be affected by the specifications and performance of the device.

Battery Information

A rechargeable battery has a long service life if treated properly. A new battery or one that has not been used for a long period of time could have reduced capacity the first few times it is used. Do not expose the battery to extreme temperatures, never above +122°F (+50°C) or below +14°F (-10°C). For maximum battery capacity, use the battery at room temperature. If the battery is used in low temperatures, the battery capacity will be reduced. The battery can only be charged in temperatures between +32°F (0°C) and +113°F (+45°C).

[For coin battery application]

WARNING

- **INGESTION HAZARD:** This product contains a button cell or coin battery.
- **DEATH** or serious injury can occur if ingested.
- A swallowed button cell or coin battery can cause **Internal Chemical Burns** in as little as **2 hours**.
- **KEEP** new and used batteries **OUT OF REACH of CHILDREN**
- **Seek immediate medical attention** if a battery is suspected to be swallowed or inserted inside any part of the body.



- Remove and immediately recycle or dispose of used batteries according to local regulations and keep away from children. Do NOT dispose of batteries in household trash or incinerate.
- Even used batteries may cause severe injury or death.
- Call a local poison control center for treatment information.
- The compatible battery type is only VDL 1 240H
- The nominal battery voltage is 3.85 V
- Non-rechargeable batteries are not to be recharged.
- Do not force discharge, recharge, disassemble, heat above (manufacturer's specified temperature rating) or incinerate. Doing so may result in injury due to venting, leakage or explosion resulting in chemical burns.
- The product contains non-replaceable batteries.

Registered Trademarks and Licenses

All trademarks and trade names are owned by their respective owners.



“Made for iPhone” mean that an electronic accessory has been designed to connect specifically to iPhone, respectively, and has been certified by the developer to meet Apple performance standards. Apple is not responsible for the operation of this device or its compliance with safety and regulatory standards. Please note that the use of this accessory with iPhone may affect wireless performance.



Dolby, Dolby Atmos, and the double-D symbol are registered trademarks of Dolby Laboratories Licensing Corporation. Manufactured under license from Dolby Laboratories. Confidential unpublished works. Copyright © 2012–2020 Dolby Laboratories. All rights reserved.



Snapdragon Sound is a product of Qualcomm Technologies, Inc. and/or its subsidiaries. Snapdragon and Snapdragon Sound are trademarks or registered trademarks of Qualcomm Incorporated.



Open Source Software Notice Information

To obtain the source code that is contained in this product, under GPL, LGPL, MPL, and other open source licenses that have the obligation to disclose source code, and to access all referred license terms, copyright notices and other relevant documents, please visit <https://opensource.lge.com>.

LG Electronics will also provide open source code to you on CD-ROM for a charge covering the cost of performing such distribution (such as the cost of media, shipping, and handling) upon email request to opensource@lge.com.

This offer is valid to anyone in receipt of this information for a period of three years after our last shipment of this product.

	<p style="text-align: center;">RISK GROUP 3</p> <p>WARNING: UV-C EMITTED FROM THIS PRODUCT. AVOID EYE AND SKIN EXPOSURE TO UNSHIELDED PRODUCT.</p> <p>WARNING: If you do not charge or open the charging case, the UV function does not operate.</p>
---	---

Symbols

~ : Alternating current (AC)

— : Direct current (DC)

⊞ : Class II equipment

⏻ : Standby power state

⏻ : Power is turned on.

⚡ : Dangerous voltage

⚠ : CAUTION

📖 : Instructions

⊕ : Coin / button cell battery

The spelling errors or inaccurate contents in this user manual are subject to change without prior notice by LG Electronics.

The output level shall automatically return to an output level not exceeding RS1 when the power is switched off.

Cleaning Guide

| Cleaning Earbud

Clean the speaker hole and air ventilation hole regularly so that they are not blocked by foreign substances (sebum, earwax, etc.).

*If the speaker hole and air ventilation hole are blocked, volume may be low, noise may occur, and the noise canceling performance may be affected.

- 1** First, separate the ear tip by holding the earbud and carefully pulling the ear gel outwards.

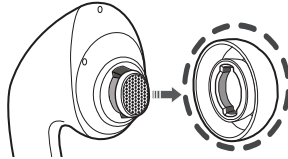

- 2** Then, clean the hole with a soft brush or cotton swab.

