

OWNER'S MANUAL

# KARAOKE MINI HI-FI SYSTEM

Please read this manual carefully before operating your set and retain it for future reference.

MODEL

DM8360K (DM8360K, DMS8360F)



# Safety Information



**CAUTION**  
RISK OF ELECTRIC SHOCK  
DO NOT OPEN



**CAUTION:** TO REDUCE THE RISK OF ELECTRIC SHOCK DO NOT REMOVE COVER (OR BACK) NO USER-SERVICEABLE PARTS INSIDE REFER SERVICING TO QUALIFIED SERVICE PERSONNEL



This lightning flash with arrowhead symbol within an equilateral triangle is intended to alert the user to the presence of uninsulated dangerous voltage within the product's enclosure that may be of sufficient magnitude to constitute a risk of electric shock to persons.



The exclamation point within an equilateral triangle is intended to alert the user to the presence of important operating and maintenance (servicing) instructions in the literature accompanying the product.

**WARNING:** TO PREVENT FIRE OR ELECTRIC SHOCK HAZARD, DO NOT EXPOSE THIS PRODUCT TO RAIN OR MOISTURE.

**CAUTION:** The apparatus should not be exposed to water (dripping or splashing) and no objects filled with liquids, such as vases, should be placed on the apparatus.

**WARNING:** Do not install this equipment in a confined space such as a book case or similar unit.

**CAUTION:** Do not use high voltage products around this product. (ex. Electrical swatter) This product may malfunction due to electrical shock.



**CAUTION:** This product employs a Laser System. To ensure proper use of this product, please read this owner's manual carefully and retain it for future reference. Shall the unit require maintenance, contact an authorized service center.

Use of controls, adjustments or the performance of procedures other than those specified herein may result in hazardous radiation exposure. To prevent direct exposure to laser beam, do not try to open the enclosure.

**CAUTION:** Do not block any ventilation openings. Install in accordance with the manufacturer's instructions.

Slots and openings in the cabinet are provided for ventilation and to ensure reliable operation of the product and to protect it from over heating. The openings shall be never be blocked by placing the product on a bed, sofa, rug or other similar surface. This product should not be placed in a built-in installation such as a bookcase or rack unless proper ventilation is provided or the manufacturer's instruction has been adhered to.

**NOTICE:** For safety marking information including product identification and supply ratings, please refer to the main label on the bottom or the other surface of the product.

**CAUTION concerning the Power Cord**

The Power Plug is the disconnecting device. In case of an emergency, the Power Plug must remain readily accessible.

Check the specification page of this owner's manual to be certain of the current requirements.

Do not overload wall outlets. Overloaded wall outlets, loose or damaged wall outlets, extension cords, frayed power cords, or damaged or cracked wire insulation are dangerous. Any of these conditions could result in electric shock or fire. Periodically examine the cord of your device, and if its appearance indicates damage or deterioration, unplug it, discontinue use of the device, and have the cord replaced with an exact replacement part by an authorized service center. Protect the power cord from physical or mechanical abuse, such as being twisted, kinked, pinched, closed in a door, or walked upon. Pay particular attention to plugs, wall outlets, and the point where the cord exits the device.

This device is equipped with a portable battery or accumulator.

**How to Safely remove the batteries or the battery pack from the equipment:**

To Remove the old batteries or battery pack, follow the assembly steps in reverse order. To prevent contamination of the environment and bring on possible threat to human and/or animal health, the old batteries or the battery pack must be put in an appropriate container at designated collection points. Do not dispose of batteries or battery pack together with other waste. It is recommended that you use local, free reimbursement systems batteries or battery packs, (may not be available in your area). The batteries or the battery pack should not be exposed to excessive heat such as sunshine, fire or the like.

**Caution:** No naked flame sources, such as lighted candles, should be placed on the apparatus.

**Symbols**

~	Refers to alternating current(AC).
≡	Refers to direct current(DC).
⊞	Refers to class II equipment.
⏻	Refers to stand-by.
I	Refers to "ON" (power).
⚡	Refers to dangerous voltage.

# Table of Contents

## 1 Getting Started

---

- 2 Safety Information
- 6 Unique Features
- 6 Introduction
  - 6 – Playable Discs
  - 6 – About the “” Symbol Display
  - 7 – Symbols Used in this Manual
  - 7 – Regional Codes
- 7 Playable file Requirement
  - 7 – Music file requirement
  - 7 – Photo file requirement
  - 8 – Video file requirement
  - 8 – Compatible USB Devices
  - 8 – USB device requirement
- 9 Remote control
- 10 Front panel
- 11 Rear panel

## 2 Connecting

---

- 12 How to affix the ferrite core
  - 12 – Affix the ferrite core for power cord
- 12 Connecting to speakers
- 13 Connections to Your TV
  - 13 – HDMI Out Connection
  - 15 – Resolution Setting
- 15 Optional Equipment Connection
  - 15 – AUX IN Connection
  - 16 – AUX OUT Connection
  - 16 – PORT IN Connection
  - 17 – USB Connection
  - 17 – Antenna Connection

## 3 System Setting

---

- 18 Adjust the setup settings
  - 18 – OSD Initial language settings - Optional
  - 18 – To display and exit the Setup menu
- 19 – Language
- 19 – Display
- 20 – Audio
- 20 – Lock (Parental Control)

## 4 Operating

---

- 22 Using the Home Menu
- 22 Basic Operations
- 24 Playback Effect
  - 24 – AUTO DJ
- 25 Using BLUETOOTH® wireless technology
  - 25 – Listening to music stored on the Bluetooth devices
- 27 Radio Operations
  - 27 – Listening to the radio
  - 27 – Improving poor FM reception
  - 27 – Presetting the Radio Stations
  - 27 – Deleting all the saved stations
  - 27 – Deleting a saved station
- 28 Sound adjustment
  - 28 – Setting the sound mode
  - 28 – Setting the USER EQ
- 29 Advanced Operations
  - 29 – Displaying Disc Information on-screen
  - 29 – To display the DVD Menu
  - 29 – To display the DVD title
  - 29 – 1.5 times speed playback
  - 29 – Screen Saver
  - 29 – Starting play from selected time
  - 29 – Resume playback
  - 30 – Changing subtitle code page
    - Optional
  - 30 – Marked Playback

31	– Viewing a PHOTO file
32	Other Operations
32	– Sleep Timer Setting
32	– Dimmer
32	– Last Scene Memory
32	– Power Resume - Optional
32	– System Select - Optional
32	– Turn off the sound temporarily
33	– CHILDSAFE Mode
33	– DEMO
33	– VOICE CANCELLER
34	– Using Microphone
34	Setting the Clock
35	– Using your player as an alarm clock
35	Auto power down
36	– AUTO POWER On
36	– Auto function change
37	LG Sound Sync

## 5 Troubleshooting

---

38	Troubleshooting
----	-----------------

## 6 Appendix

---

40	Controlling a TV with the Supplied Remote Control
40	– Setting up the remote to control your TV
41	Area Code List
42	Language code List
43	Trademarks and Licenses
44	Maintenance
44	– Notes on Discs
44	– Handling the Unit
45	General specifications
46	Speakers specifications

1

2

3

4

5

6

## Unique Features

### Bluetooth®

Listens to music stored on your **Bluetooth** device.

### Portable In

Listens to music from your portable device. (MP3, Notebook, etc.)

### AUTO DJ

Blends the end of one song into the beginning of another for seamless playback.

### LG Sound Sync

Controls volume level of this unit by the remote control of your LG TV that is compatible with LG Sound Sync.

### Full HD up-scaling

Views Full HD picture quality with simple setup.

## Introduction

### Playable Discs

This unit plays DVD±R/RW and CD-R/RW that contains audio titles, MP3, WMA and/or JPEG files. Some DVD±RW/DVD±R or CD-RW/CD-R cannot be played on this unit due to the recording quality or physical condition of the disc, or the characteristics of the recording device and authoring software.



DVD-VIDEO (8 cm/12 cm disc)

Discs such as movies that can be purchased or rented.



DVD±R (8 cm/12 cm disc)

Video mode and finalized only.



DVD-RW (8 cm/12 cm disc)

Video mode and finalized only.



DVD+R: Video mode only

Supports the double layer disc also.



DVD+RW (8 cm/12 cm disc)

Video mode and finalized only.



Audio CD: Music CDs or CD-R/CD-RW in music CD format that can be purchased.

### About the “⊙” Symbol Display

“⊙” may appear on your TV display during operation and indicates that the function explained in this owner’s manual is not available on that specific media.

## Symbols Used in this Manual

### DVD

DVD-Video, DVD±R/RW in Video mode or VR mode and finalized

### ACD

Audio CDs

### MOVIE

Video files contained in the USB/Disc

### MUSIC

Audio files contained in the USB/Disc

### PHOTO

Photo files contained in the USB/Disc

### ! Note

Indicates special notes and operating features.

### ! Tip

Indicates tip and hints for making the task easier.

### ! Caution

Indicates cautions for preventing possible damages from abuse.

## Regional Codes

This unit has a regional code printed on the rear of the unit. This unit can play only DVD discs labeled same as the rear of the unit or "ALL"

- Most DVD discs have a globe with one or more numbers in it clearly visible on the cover. This number must match your unit's regional code or the disc cannot play.
- If you try to play a DVD with a different regional code from your unit, the message "Check Regional Code" appears on the TV screen.

## Playable file Requirement

### Music file requirement

MP3/WMA file compatibility with this unit is limited as follows.

- Sampling frequency : within 32 to 48 kHz (MP3), within 32 to 48 kHz (WMA)
- Bit rate : within 32 to 320 kbps (MP3), 40 to 192 kbps (WMA)
- Support Version : v2, v7, v8, v9
- Maximum files : Under 999
- File extensions : ".mp3"/ ".wma"
- Certain MP3/WMA files may not be played depending on the type or format of the file.
- CD-ROM file format : ISO 9660/ JOLIET
- We recommend that you use Easy-CD Creator, which creates an ISO 9660 file system.

The DTS is not supported. In case of DTS audio format, audio is not output.

You have to set the disc format option to [Mastered] in order to make the discs compatible with the LG players when formatting rewritable discs. When setting the option to Live File System, you cannot use it on LG players.

(Mastered/Live File System : Disc format system for Windows Vista)

### Photo file requirement

Photo file compatibility with this unit is limited as follows :

- Max pixel in width : 2760 x 2048 pixel
- Maximum files : Under 999
- Some discs may not operate due to a different recording format or the condition of disc.
- File extensions: ".jpg"
- CD-ROM file format : ISO9660/ JOLIET

## Video file requirement

Video file compatibility with this unit is limited as follows:

- Available resolution: within 720 x 576 (W x H) pixels.
- The file name of the Video subtitle should be entered within 45 characters.
- If there is impossible code to express in the Video file, it may be displayed as " \_ " mark on the display.
- Frame rate : less than 30 fps.
- If the video and audio structure of recorded files is not interleaved, either video or audio is outputted.
- Playable Video file : "avi", "mpg", "mpeg"
- Playable Subtitle format : SubRip (\*.srt/ \*.txt), SAMI (\*.smi), SubStation Alpha (\*.ssa/ \*.txt), MicroDVD (\*.sub/ \*.txt), SubViewer 2.0 (\*.sub/ \*.txt), Vobsub (\*.sub)
- Playable Codec format : "Xvid", "MPEG-1", "MPEG-2"
- Playable Audio format : "AC3", "PCM", "MP3", "WMA",
- Sampling frequency : within 32 to 48 kHz (MP3), within 32 to 48 kHz (WMA)
- Bit rate : within 32 to 320 kbps (MP3), 40 to 192 kbps (WMA)
- For Discs formatted in Live file system, you can not it on this unit.
- If the name of movie file is different from that of the subtitle file, during playback of a Video file, subtitle may not be display.
- If you play a Xvid file differ from Xvid spec, it may not operate normally.
- If you play GMC video file which is more than 1-warp point, video playback screen will not smooth.

## Compatible USB Devices

- MP3 Player : Flash type MP3 player.
- USB Flash Drive :  
Devices that support USB2.0 or USB1.1.
- The USB function of this unit does not support all USB devices.

## USB device requirement

- Devices which require additional program installation when you have connected it to a computer, are not supported.
- Do not extract the USB device while in operation.
- For a large capacity USB, it may take longer than a few minute to be searched.
- To prevent data loss, back up all data.
- If you use a USB extension cable or USB hub, the USB device is not recognized.
- Using NTFS file system is not supported. (Only FAT(16/ 32) file system is supported.)
- This unit is not supported when the total number of files is 1,000 or more.
- External HDD, Card readers, Locked devices, or hard type USB devices are not supported.
- USB port of the unit cannot be connected to PC. The unit cannot be used as a storage device.
- Some USB may not work with this unit.

# Remote control

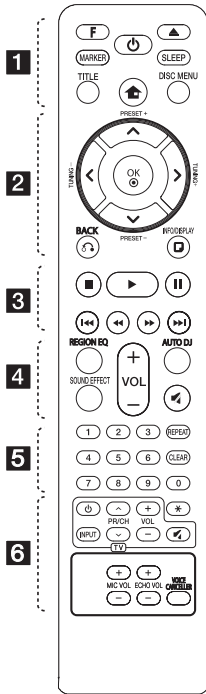

## Replacement of battery

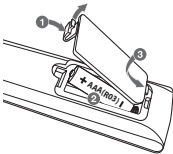

Remove the battery cover on the rear of the remote control, and insert the battery with **+** and **-** matched correctly.

..... **1** .....

**F (Function)** : Selects the function and input source.

**MARKER** : Marks play list.

**⏻ (Standby/On)** : Switches the unit ON or OFF.

**⏮ (Open/Close)** : Opens and closes the disc tray.

**SLEEP** : Sets the System to turn off automatically at a specified time. (Dimmer : The display window will be darken by half)

**TITLE** : If the current DVD title has a menu, the title menu appears on the screen. Otherwise, the disc menu may not appear.

**🏠 (Home)** : Displays the [Home Menu].

**DISC MENU** : Accesses the menu on a DVD disc.

..... **2** .....

**⬆ / ⬇ / ⬅ / ➡** (up/ down/ left/ right) : Used to navigate on-screen displays.

**PRESET +/-** : Selects programme of Radio.

**TUNING +/-** : Tunes in the desired radio station.

**⊙ OK** : Acknowledges menu selection. Presetting the radio stations.

**⏪ BACK** : Moves backwards in the menu or exits the setup menu.

**📺 INFO/DISPLAY** : Accesses On-Screen Display.

See the name of connected Bluetooth device in Bluetooth mode.

..... **3** .....

**■ (Stop)** : Stops playback.

**▶ (Play)** : Starts playback.

**⏸ (Pause)** : Pauses playback.

Selects Stereo/Mono.

**⏮ / ⏭ (Skip)** : Goes to the next or previous chapter / track / file.

**⏪ / ⏭ (Scan)** : Searches backward or forward.

..... **4** .....

**REGION EQ** : Chooses sound impressions.

**SOUND EFFECT** : Selects a sound effect mode.

**VOL +/- (Volume)** : Adjusts speaker volume.

**AUTO DJ** : Selects the AUTO DJ mode. (For more information refer to page 24)

**🔇 (Mute)** : Mutes the sound.

..... **5** .....

**0-9 numerical buttons** : Selects numbered options in a menu.

**REPEAT** : Selects a play mode. (Repeat/ Random)

**CLEAR** : Removes a number when setting the password.

..... **6** .....

**TV Control buttons**: See page 40.

**★** : This button is not available.

**MIC VOL +/- (Microphone Volume)** : Adjusts microphone volume.

**ECHO VOL +/- (Volume)** : Adjusts echo volume.

**VOICE CANCELLER**: You can enjoy the function as karaoke, by reducing singer vocal of music in the various source

## Front panel

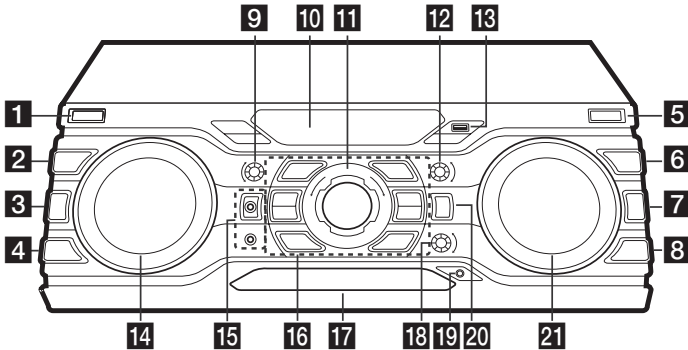

### 1 (Standby/On)

Turn the power on or off.

### 2 **CLOCK**

Sets a clock and checks a time.

### 3 **OK / SET**

- Acknowledges menu selection.
- Presetting the radio stations.

### 4 **ALARM**

With the ALARM function you can turn Disc, USB play and Tuner reception on at a desired time.

### 5 **DEMO / REPEAT**

- Shows Demo mode.
- Listens to your tracks/files repeatedly or randomly.

### 6 **REGION EQ**

Chooses region equalizer.

### 7 **VOICE CANCELLER**

You can enjoy the function as karaoke, by reducing singer vocal of music in the various source

### 8 **BASS BLAST**

Press to select BASS effect directly.

### 9 **ECHO VOL** (Volume)

Adjusts echo volume.

### 10 **Display window**

### 11 **MASTER VOLUME**

Adjusts speaker volume.

### 12 **MIC VOL** (Microphone Volume)

Adjusts Mic volume.

### 13 **USB Port**

You can play sound files by connecting the USB device.

### 14 **MULTI CONTROL / TUNING**

- Moves to the another file/ track.
- Tunes in the desired radio station.
- Adjusts clock time or alarm setting.

### 15 **MIC 1 / 2** (Microphone) jack

Connect a microphone.

### 16 (Stop)

Stops playback.

### (Play/Pause)

- Starts or pauses playback.
- Selects Stereo/Mono.

### (Open/Close)

Opens and closes the disc tray.

### **USER EQ**

Selects the sound effect created by your own.

### **HOME**

Goes to Home menu.

### **AUTO DJ**

Selects the AUTO DJ mode.

### (Skip)

Goes to the next or previous chapter / track / file.

- 17** Disc tray
- 18** **USER EQ LEVEL**  
Controls sound register.
- 19** **PORT. (Portable) IN** jack  
Connect a portable device.
- 20** **F (Function)**  
Selects the function and input source.
- 21** **SOUND EFFECT**  
Selects a sound effect mode.

## Rear panel

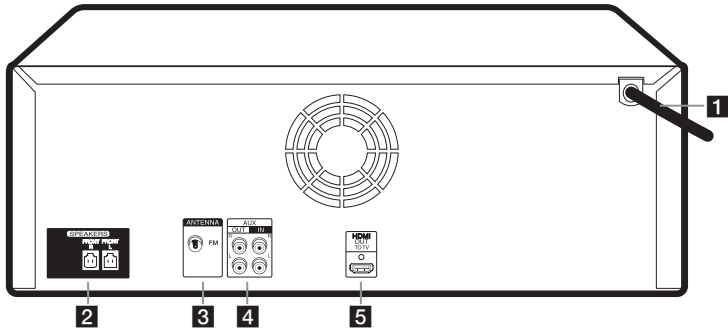

**1** Power cord



### Caution

- Connect the power cord to wall outlet directly if possible. Or when you use an extension cable, it is highly recommended to use an extension cable of 110 V / 15 A or 230 V / 15 A, otherwise the unit may not operate properly because of the lack of power supply.
- Do not overload the extension cord with excessive electrical load.

**2** SPEAKERS connector

**3** ANTENNA (FM)

**4** AUX IN (L/R)  
AUX OUT (L/R)

**5** HDMI OUT TO TV

## How to affix the ferrite core

Ferrite core may not be provided depending on each nation's regulations.

### Affix the ferrite core for power cord

You must affix a ferrite core in order to reduce or eliminate electrical interference.

1. Pull the stopper [a] of the ferrite core to open.
2. Wind the power cord around the ferrite core once.  
Wind the SPEAKERS cables around the ferrite core once.
3. Close the ferrite core until it clicks.

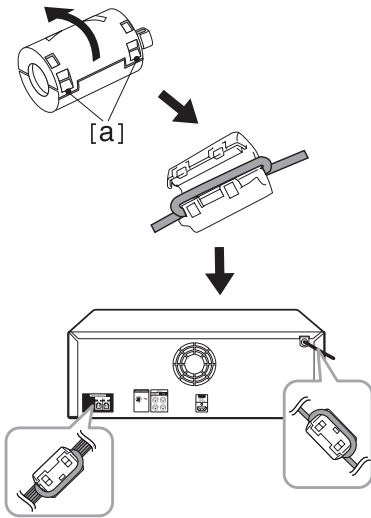

## Connecting to speakers

Connect the speaker cable plugs to the SPEAKERS connector. Make sure to connect the speaker's plug to the corresponding colored speaker connector when connecting the plug.

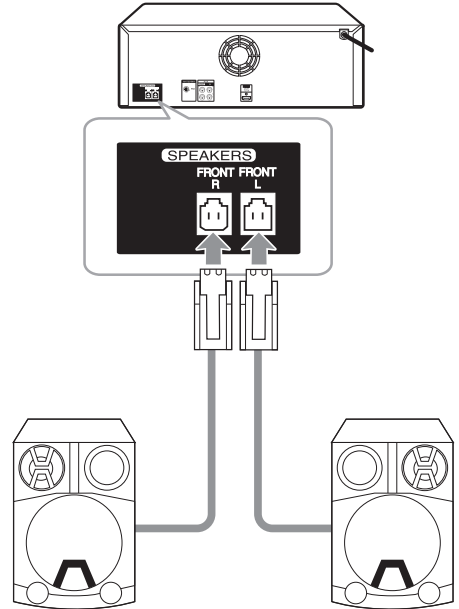

**! Caution**

- Do not try to lift the speaker alone. It needs two persons to lift the speaker. Otherwise it may result in the speaker malfunction and cause personal injury and/or property damage.
- When you connect the speakers to the unit, make sure to connect the speaker's cable and plug to the corresponding speaker connector.
- Check the volume level before playing music to prevent infirm, child, and pregnant women from being shocked by the sudden and loud sound from the unit.
- Do not use the unit in a limited space. It may damage a person's hearing. It is recommended to use it in a wide space.
- Be careful to make sure children not to put their hands or any objects into the opening speaker duct hole.
- Use the speaker supplied with this unit only. Using any other speaker may cause malfunction.
- The speakers contain magnet parts, so color irregularity may occur on the TV screen or PC monitor screen. Please use the speakers far away from either TV screen or PC monitor.
- Do not press the diaphragm or the dust cap of the speaker.

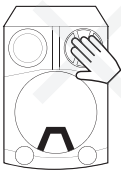

## Connections to Your TV

### HDMI Out Connection

If you have a HDMI TV or monitor, you can connect it to this unit using a HDMI cable (Type A, High Speed HDMI™ Cable).

Connect the HDMI OUT jack on the unit to the HDMI IN jack on a HDMI compatible TV or monitor. Set the TV's source to HDMI (refer to TV's Owner's manual).

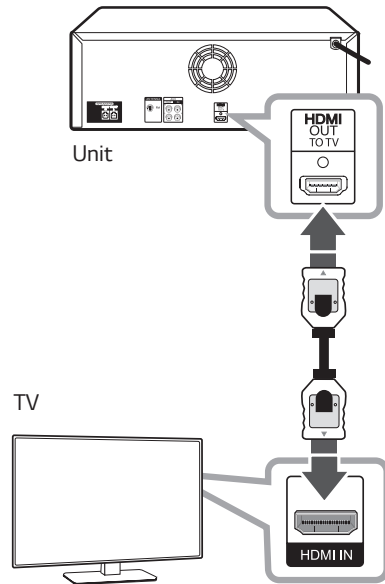
**! Tip**

- You can fully enjoy digital audio and video signals together with this HDMI connection.
- When you use HDMI connection, you can change the resolution for the HDMI output. (Refer to "Resolution Setting" on page 15.)

**Caution**

- Changing the resolution when the connection has already been established may result in malfunctions. To solve the problem, turn off the unit and then turn it on again.
- When the HDMI connection with HDCP is not verified, TV screen is changed to black or green screen or the snow noise may occur on the screen. In this case, check the HDMI connection, or disconnect the HDMI cable.
- Make sure the unit is connected directly to the TV. Tune the TV to the correct video input channel.



**Note**

- If a connected HDMI device does not accept the audio output of the unit, the HDMI device's audio sound may be distorted or may not output.
- When you connect a HDMI or DVI compatible device make sure of the following:
  - Try switching off the HDMI/DVI device and this unit. Next, switch on the HDMI/DVI device and leave it for around 30 seconds, then switch on this unit.
  - The connected device's video input is set correctly for this unit.
  - The connected device is compatible with 720 x 480i (or 576i), 720 x 480p (or 576p), 1280 x 720p, 1920 x 1080i or 1920 x 1080p video input.
- Not all HDCP-compatible HDMI or DVI devices will work with this unit.
  - The picture will not be displayed properly with non-HDCP device.
  - This unit does not playback and TV screen is changed to black or green screen or the snow noise may occur on the screen.
- If there is noise or lines on the screen, please check the HDMI cable and use a higher version cable than High Speed HDMI™ Cable.
- If you use LG TV or Bluetooth Function of the unit, the audio is not output to HDMI.

## Resolution Setting

The unit provides several output resolutions for HDMI OUT.

You can change the resolution using [Setup] menu.



1. Press **HOME** on the unit or  on the remote control.
2. Use **MULTI CONTROL / TUNING** on the unit or  on the remote control to select the [Setup] and press **OK / SET** on the unit or  **OK** on the remote control. The [Setup] menu appears.



3. Use **▲/▼** to select [Display] option then press **>** to move to the second level.
4. Use **▲/▼** to select the [Resolution] option then press **>** to move to the third level.
5. Use **▲/▼** to select the desired resolution then press  **OK** to confirm your selection.

### Note

If your TV does not accept the resolution you have set on the player, you can set resolution to 480p (or 576p) as follows:

Press  on the remote control or  on the unit for more than 5 seconds.

## Optional Equipment Connection

### AUX IN Connection

Connect an output of auxiliary device (Camcorder, TV, Player, etc) to the **AUX IN** (L/R) connector.

If your device has only one output for audio (mono), connect it to the left audio jack on the unit.

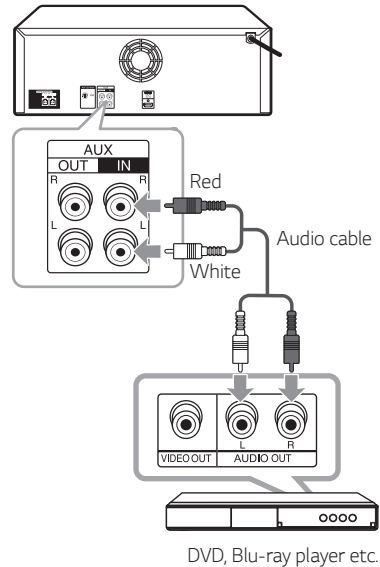

## AUX OUT Connection

Connect an input of auxiliary device to the AUX OUT (L/R) connector.

If your device has only one input for audio(mono), connect it to the left audio jack on the unit.

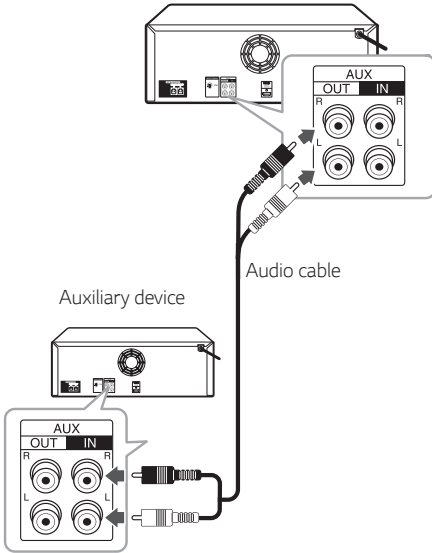

## PORT. IN Connection

Connect an output (earphone or line out) of portable device (MP3 or PMP etc) to the **PORT. IN** connector.

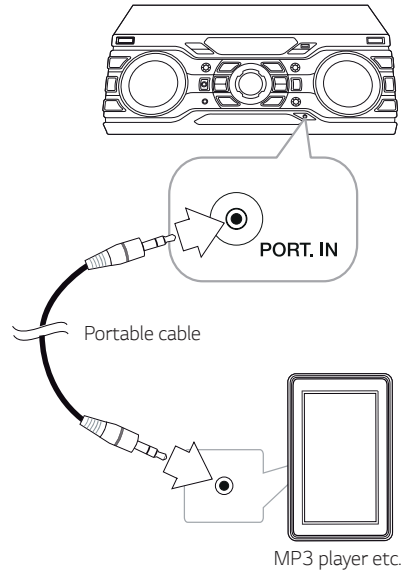

## Listening to music from your portable player or external device

The unit can be used to play the music from many types of portable player or external device.

1. Connect the portable player to the PORT. IN connector on the unit.  
Or  
Connect the external device to the AUX IN connector on the unit.
2. Turn the power on by pressing **⏻** on the unit or **⏻** on the remote control.
3. Press **F** to select AUX or PORTABLE Function.
4. Turn on the portable player or external device and start it playing.

## USB Connection

Connect a USB device (or MP3 player, etc.) to the USB ports on the unit.

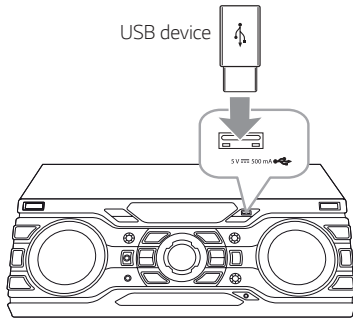

### ! Note

Removing the USB device from the unit :

1. Choose a different function/mode or press **■** on the remote control or **□** on the unit twice in a row.
2. Remove the USB device from the unit.

## Antenna Connection

Connect the supplied FM antenna for listening to the radio.

Connect the FM wire antenna to the FM antenna connector.

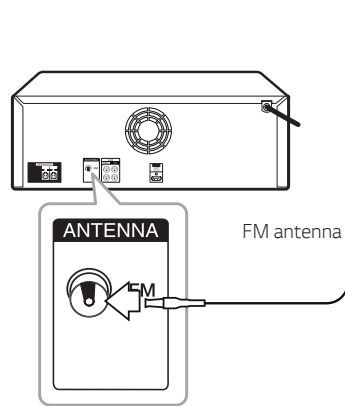

### ! Note

Be sure to fully extend the FM wire antenna.

## Adjust the setup settings

By using the Setup menu, you can make various adjustments to items such as picture and sound.

You can also set a language for the subtitles and the Setup menu, among other things. For details on each Setup menu item, see pages 18 to 21.

## OSD Initial language settings - Optional

During the first use of this unit, the initial language setup menu appears on your TV screen. You must complete initial language selection before using the unit. English will be selected as the initial language.

1. Press **POWER** on the unit or **POWER** on the remote control to turn the unit on. The language setup menu will appear on the screen.
2. Use **UP** **DOWN** **LEFT** **RIGHT** to select a language then press **OK / SET** on the unit or **OK** on the remote control. The confirm menu will appear.

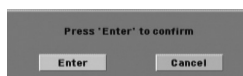

3. Use **LEFT** **RIGHT** to select the [Enter] then press **OK / SET** on the unit or **OK** on the remote control to finish the language setup.

## To display and exit the Setup menu

1. Press **HOME** on the unit or **HOME** on the remote control. Displays the [Home Menu].



2. Select an [Setup] by using **MULTI CONTROL / TUNING** on the unit or **LEFT** **RIGHT** on the remote control.
3. Press **OK / SET** on the unit or **OK** on the remote control. Displays the [Setup].
4. Press **HOME** or **BACK** on the remote control to exit in the [Setup] Menu. Or press **HOME** on the unit.

### About help menu for Setup

Menu	Buttons	Operation
▲▼ Move	▲ ▼	Moving to another menu.
◀ Move	<	Moving to previous level.
▶ Move	>	Moving to next level or selecting menu.
↶ Close	↶ BACK	To exit the [Setup] menu.
⊙ Select	⊙ OK	To confirm menu.

## Language

### Menu Language

Select a language for the Setup menu and on screen display.

### Disc Audio / Disc Subtitle / Disc Menu

Select the language you prefer for the audio track (disc audio), subtitles, and the disc menu.

---

#### [Original]

Refers to the original language in which the disc was recorded.

---

#### [Other]

To select another language, press numeric buttons and then **OK / SET** on the unit or **OK** on the remote control to enter the corresponding 4-digit number according to the language code list on the page 42. If you enter the wrong language code, press **CLEAR**.

---

#### [Off (for Disc Subtitle)]

Turns off Subtitle.

---

## Display

### TV Aspect

Select the screen aspect to use based on the shape of your TV screen.

---

#### [4:3]

Select when a standard 4:3 TV is connected.

---

#### [16:9]

Select when a 16:9 wide TV is connected.

---

### Display Mode

The Display Mode setting works only when the TV Aspect mode is set to 4:3.

---

#### [Letterbox]

Displays a wide picture with bands on the upper and lower portions of the screen.

---

#### [Panscan]

Automatically displays the wide picture on the entire screen and cuts off the portions that do not fit. (If the disc/file is not compatible with Pan Scan, the picture is displayed at Letterbox ratio.)

---

## Resolution

Sets the output resolution of HDMI video signal. Refer to "Resolution Setting" for details about the resolution (page 15).

---

#### [Auto]

If the HDMI OUT jack is connected to TVs providing display information (EDID), automatically selects the resolution best suited to the connected TV.

---

#### [1080p]

Outputs 1080 lines of progressive video.

---

#### [1080i]

Outputs 1080 lines of interlaced video.

---

#### [720p]

Outputs 720 lines of progressive video.

---

#### [480p (or 576p)]

Outputs 480 (or 576) lines of progressive video.

---

#### [480i (or 576i)]

Outputs 480 (or (576) lines of interlaced video.

---

## Audio

### DRC (Dynamic Range Control)

Make the sound clear when the volume is turned down (Dolby Digital only). Set to [On] for this effect.

### Vocal

Select [On] to mix karaoke channels into normal stereo.

This function is effective for multi-channel karaoke DVDs only.

### HD AV Sync

Sometimes Digital TV encounters a delay between picture and sound. If this happens you can compensate by setting a delay on the sound so that it effectively 'waits' for the picture to arrive: this is called HD AV Sync. Use **Λ V** (on the remote control) to scroll up and down through the delay amount, which you can set at anything between 0 and 300ms.

### Semi Karaoke

When a chapter/ title/ track is fully finished, this function shows the score in the screen with a fanfare sound.

---

#### [On]

When you finished singing a score will appear on the screen.

---

#### [Off]

Fanfare and score do not appear on the screen.

---

#### Note

- DVD, DVD Karaoke discs with more than 2 tracks are available discs for the this function.
- When you watch movies, "off" the Semi Karaoke at the SETUP menu or enjoy it without connecting the MIC if the fanfare or score appears during changing a chapter.
- This function operate on the DVD/CD mode.
- The Semi Karaoke function is available only when a microphone is connected.
- If you do not use the microphone, turn down the volume and disconnect the microphone.

## Lock (Parental Control)

### Initial Setting the Area Code:

When you use this unit for the first time, you have to set the Area Code.

1. Select the [Lock] menu and then press **>**.
2. Press **>**.

To access the [Lock] options, you must input the password you have created. Input a password and press **OK / SET** on the unit or **OK** on the remote control. Enter it again and press **OK / SET** on the unit or **OK** on the remote control to verify. If you make a mistake before pressing **OK / SET** on the unit or **OK** on the remote control, press **CLEAR**.

3. Select the first character using **Λ V** buttons.
4. Press **OK / SET** on the unit or **OK** on the remote control and select the second character using **Λ V** buttons.
5. Press **OK / SET** on the unit or **OK** on the remote control to confirm your Area code selection.

### Rating

Blocks playback of rated DVDs based on their contents. Not all discs are rated.

1. Select [Rating] on the [Lock] menu then press **>**.
2. Input a password and press **OK / SET** on the unit or **OK** on the remote control.
3. Select a rating from 1 to 8 using the **Λ V** buttons.

---

#### [Rating 1-8]

Rating one (1) has the most restrictions and rating eight (8) is the least restrictive.

---

#### [Unlock]

If you select unlock, parental control is not active and the disc plays in full.

---

4. Press **OK / SET** on the unit or **OK** on the remote control to confirm your rating selection.

## Password

You can enter or change password.

1. Select [Password] on the [Lock] menu and then press **>**.
2. Press **OK / SET** on the unit or **OK** on the remote control.
3. Input a password and press **OK / SET** on the unit or **OK** on the remote control.

To change the password, press **OK / SET** on the unit or **OK** on the remote control when the [Change] option is highlighted. Input a password and press **OK / SET** on the unit or **OK** on the remote control. Enter it again and press **OK / SET** on the unit or **OK** on the remote control to verify.

4. Press **HOME** on the unit or **HOME** on the remote control to exit the menu.

### Note

If you forget your password, you can clear it using the following steps:

1. Select the [Setup] menu on the [Home Menu].
2. Input the 6-digit number "210499" and press **OK / SET** on the unit or **OK** on the remote control. The password is cleared.

## Area Code

Enter the code of the area whose standards were used to rate the DVD video disc, based on the list on page 41.

1. Select [Area Code] on the [Lock] menu then press **>**.
2. Input a password and press **OK / SET** on the unit or **OK** on the remote control.
3. Select the first character using **▲ ▼** buttons.
4. Press **OK / SET** on the unit or **OK** on the remote control and select the second character using **▲ ▼** buttons.
5. Press **OK / SET** on the unit or **OK** on the remote control to confirm your Area code selection.

## Using the Home Menu

1. Press **HOME** on the unit or  on the remote control.  
Displays the [Home Menu].







2. Select an option by using **<>**.
3. Press **OK / SET** on the unit or  **OK** on the remote control then selected option menu.  
[Music] – Displays [MUSIC] menu.  
[Movie] – Start video media's playback or displays the [MOVIE] menu.  
[Photo] – Displays [PHOTO] menu.  
[Setup] – Displays the [Setup] menu.

### Note

You can not select the [Music], [Movie] or [Photo] option when the USB device is not connected or a disc is not inserted.

## Basic Operations

1. Insert the disc by pressing  on the remote control or  on the unit.  
Or connect the USB device to the USB port.
2. Press **HOME** on the unit or  on the remote control.  
Displays the [Home Menu].
3. Select an option by using **<>**.  
If you select the [Movie], [Photo] or [Music] option when you connect up to two devices, it appears as follows. Select a media then press **OK / SET** on the unit or  **OK** on the remote control.



4. Press **OK / SET** on the unit or  **OK** on the remote control then selected option menu.

### Note

- For the most Audio CD and DVD-ROM discs, playback starts automatically.
- The unit plays only music file contained in the USB storage device or disc automatically.

To	Do this
Stop	Press <b>■ STOP</b> on the remote control or <b>□</b> on the unit.
Playback	Press <b>▶</b> on the remote control or <b>&gt;  </b> on the unit.
Pause	Press <b>  </b> on the remote control or <b>&gt;  </b> on the unit during playback.
Frame-by-Frame playback	Press <b>  </b> repeatedly to play title Frame-by-Frame. (DVD Movie title, Movie file only)
Skipping to the next/ previous chapter/ track/ file	During playback, press <b> &lt;&lt;&lt; / &gt;&gt;&gt; </b> on the unit or <b> &lt;&lt;&lt;/&gt;&gt;&gt; </b> on the remote control to go to the next chapter/ track/ file or to return to the beginning of the current chapter/ track/ file. Press <b> &lt;&lt;&lt;</b> on the unit or <b> &lt;&lt;&lt;</b> on the remote control twice briefly to step back to the previous chapter/ track/ file.
Locating a point quickly by playing a file in fast forward or fast reverse	During playback, press <b> &lt;&lt;&lt; / &gt;&gt;&gt; </b> on the unit or <b> &lt;&lt;&lt;/&gt;&gt;&gt; </b> on the remote control repeatedly to select the required scan speed. To return to normal speed, press <b>▶</b> on the remote control or <b>&gt;  </b> on the unit.
Playing repeatedly or randomly	Press <b>REPEAT</b> repeatedly, and the current title, chapter or track will be played back repeatedly or randomly. - DVD : Chapter/ Title/ Off - Video(MOVIE) : Title/ All/ Off - Audio CD/ MP3/ WMA : Track/ All/ Random/ Off

To	Do this
Slowing down the playing speed	In the pause mode, press <b> &lt;&lt;&lt; / &gt;&gt;&gt; </b> on the unit or <b> &lt;&lt;&lt;/&gt;&gt;&gt; </b> on the remote control to select the required speed. (DVD Movie title only)
	In the pause mode, press <b>&gt;&gt;&gt; </b> on the unit or <b>&gt;&gt;&gt; </b> on the remote control to select the required speed. (Movie file only)
Selecting a track/ file directly	Press <b>0</b> to <b>9</b> numerical buttons on the remote control to go to the desired file or track directly.

# Playback Effect



## AUTO DJ

Auto DJ blends the end of one song into the beginning of another for seamless playback. It equalizes volume across tracks/files for uninterrupted playback.

Press **AUTO DJ** on the unit or remote control repeatedly, the display changes as follows. AUTO DJ RANDOM -> AUTO DJ SEQUENTIAL -> AUTO DJ OFF

Mode	Display Window	Description
OFF	AUTO DJ OFF	-
RANDOM	AUTO DJ RANDOM	The music is played randomly on this mode.
REPEAT	AUTO DJ SEQUENTIAL	The music is played repeatedly on this mode.

### ! Note

- AUTO DJ mode does not support searching for a section within a track/file or to play repeatedly or randomly. And AUTO DJ mode does not support Marked Playback.
- If you move to other functions or stop the music by pressing  on the unit twice (or  on the remote control twice) on AUTO DJ mode, AUTO DJ will be disabled.
- AUTO DJ is not supported in the music file whose length is less than 60 seconds.
- If you press AUTO DJ during Marked playback, Marked playback will be disabled. And then AUTO DJ is played.

# Using BLUETOOTH® wireless technology

## About Bluetooth

**Bluetooth** is wireless communication technology for short range connection.

The sound may be interrupted when the connection interfered by the other electronic wave or you connect the **Bluetooth** in the other rooms.

Connecting individual devices under **Bluetooth** wireless technology does not incur any charges. A mobile phone with **Bluetooth** wireless technology can be operated via the Cascade if the connection was made via **Bluetooth** wireless technology. Available Devices : Mobile phone, MP3, Laptop, PDA. (This units be supported the Stereo Headset.)

## Bluetooth Profiles

In order to use **Bluetooth** wireless technology, devices must be able to interpret certain profiles. This unit is compatible with following profile.

A2DP (Advanced Audio Distribution Profile)

Codec : SBC

## Listening to music stored on the Bluetooth devices

### Pairing your unit and Bluetooth device

Before you start the pairing procedure, make sure the **Bluetooth** feature is activated on your **Bluetooth** device. Refer to your **Bluetooth** device's user guide. Once a pairing operation is performed, it does not need to be performed again.

1. Select the Bluetooth function by using **F** until BT function is selected.  
Appears "BT READY" in display window.
2. Operate the **Bluetooth** device and perform the pairing operation. When searching for this unit with the **Bluetooth** device, a list of the devices found may appear in the **Bluetooth** device display depending on the type of **Bluetooth** device. Your unit appears as "LG MINI(XX:XX)".

#### ! Note

XX:XX means the last four digits of BT address. For example, if your unit has a BT address such as 9C:02:98:4A:F7:08, you will see "LG MINI(F7:08)" on your Bluetooth device.

3. When this unit is successfully connected with your **Bluetooth** device, "PAIRED" appears on the display window and change to **Bluetooth** device name soon. Then "BT" will be appeared on the display window.

#### ! Note

Depending on the Bluetooth device type, some device have a different pairing way.

4. Listening to music.  
To play a music stored on your Bluetooth device, refer to your Bluetooth device's user guide.

#### ! Note

- If you change the function of the unit, the Bluetooth function is disconnected, operate pairing again.  
(Bluetooth ↔ Function other than the Bluetooth)
- Depending on the Bluetooth device type, some device have a different pairing way.  
(Enter the PIN code (0000) as needed.)

**Note**

- The sound may be interrupted when the connection interfered by the other electronic wave.
- You cannot control the Bluetooth device with this unit.
- Pairing is limited one Bluetooth device per one unit and multi-pairing is not supported.
- Depending on the type of the device, you may not be able to use the Bluetooth function.
- You can enjoy wireless system using phone, MP3, Notebook, headset, etc..
- When not connected the Bluetooth, "BT READY" appears on the display window.
- The Electrical malfunction due to devices using same frequency such as Medical equipment, Microwaves or wireless LAN devices, the connection will be disconnected.
- When someone stands and interrupts communication between Bluetooth device and the player, the connection will be disconnected.
- If the gotten away of the distance between Bluetooth and the unit, the sound quality is lower and lower the connection will disconnect when the space between the Bluetooth and the unit gets out of the operating range of Bluetooth.
- If the function is changed to Bluetooth again from other function, Bluetooth device is paired automatically.

## Radio Operations

Be sure that FM antenna is connected.  
(Refer to page 17)

### Listening to the radio

1. Press **F** on the unit or remote control until FM appears in the display window.  
The last received station is tuned in.
2. Auto tuning :  
Press and hold **TUNING -/+** on the remote control or **I<</>>I** on the unit for about two seconds until the frequency indication starts to change, then release. Scanning stops when the unit tunes in a station.

Or

Manual tuning :

Press **TUNING -/+** on the remote control or rotate **MULTI CONTROL / TUNING** on the unit repeatedly.

3. Adjust the volume by rotating volume knob on the unit or by pressing **VOL +/-** on the remote control repeatedly.

### Improving poor FM reception

Press **▶** on the remote control or **>II** on the unit.

This will change the tuner from stereo to mono and usually improve the reception.

## Presetting the Radio Stations

You can preset 50 stations for FM

Before tuning, make sure to turn down the volume.

1. Press **F** until FM appears in the display window.
2. Select the desired frequency by pressing **TUNING -/+** on the remote control or rotating **MULTI CONTROL / TUNING** on the unit.
3. Press **OK / SET** on the unit or **OK** on the remote control. A preset number will blink in the display window.
4. Press **PRESET -/+** on the remote control to select the preset number you want.
5. Press **OK / SET** on the unit or **OK** on the remote control. The station is stored.
6. Repeat steps 2 to 5 to store other stations.
7. To listen a preset station, press **PRESET -/+** or **0** to **9** numerical buttons on the remote control.

## Deleting all the saved stations

1. Press and hold **CLEAR** on the remote control for two seconds.  
"ERASEALL" will flash up on the unit display.
2. Press **CLEAR** on the remote control to erase all the saved radio stations.

## Deleting a saved station

1. Press **PRESET -/+** to select a preset number you want to delete.
2. Press **CLEAR**, the preset number will blink in the display window.
3. Press **CLEAR** again to delete the selected preset number.

## Sound adjustment

### Setting the sound mode

This system has a number of pre-set surround sound fields. The displayed items for the Equalizer may be different depending on sound sources and effects.

You can select a desired sound mode by using **SOUND EFFECT** on the unit or remote control.

On Display	Description
BASS (BASS BLAST)	Reinforces the treble, bass and surround sound effect.
POP CLASSIC ROCK JAZZ	This program lends an enthusiastic atmosphere to the sound, giving you the feeling you are at an actual rock, pop, jazz or classic concert.
FOOT BALL	You can enjoy the sound effect FOOTBALL STADIUM.
STANDARD	You can enjoy optimized sound.

You can select a desired sound mode by using **REGION EQ** on the remote control.

On Display	Region	Description
FUNK, REGUETON, SAMBA, BANDA, MERENGUE, AXE, SALSA, SERTANEJ, CUMBIA, TECNO BR, FORRO	Latin America	Optimized sound effect for the music genre preferred in each region.
ARABIC	Middle East	
DANGDUT	Indonesia	
AFRO	Africa	
INDIA	India	

### Note

- This function is not operated when the microphone is connected to the unit.
- By pressing **BASS BLAST** on the unit you can directly select BASS (BASS BLAST) effect.

### Setting the USER EQ

You can adjust the sound level of Bass and Treble as your preference.

1. Press **USER EQ** on the unit. "USER EQ" is displayed.
2. Press **USER EQ** on the unit to select BASS, MID(MIDDLE) or TRE(TREBLE).
3. Rotate **USER EQ LEVEL** knob to adjust the sound level.
4. The setting is automatically saved after 3 seconds.

## Advanced Operations

### Displaying Disc Information on-screen

You can display various information about the disc loaded on-screen.

1. Press **INFO/DISPLAY** to show various playback information.  
The displayed items differ depending on the disc type or playing status.
2. You can select an item by pressing **▲▼** and change or select the setting by pressing **◀▶**.

Title – Current title number/ total number of titles.

Chapter – Current chapter number/ total number of chapters.

Time – Elapsed playing time.

Audio – Selected audio language or channel.

Subtitle – Selected subtitle.

Angle – Selected angle/ total number of angles.

#### **Note**

If any button is not pressed for a few seconds, the on-screen display disappears.

### To display the DVD Menu

#### **DVD**

When you play a DVD which contains several menu, you can select the menu you want using the Menu.

1. Press **DISC MENU**.  
The disc's menu appears.
2. Select the menu by using **▲▼◀▶**.
3. Press **▶** to confirm.

### To display the DVD title

#### **DVD**

When you play a DVD which contains several title, you can select the title you want using the Menu.

1. Press **TITLE**.  
The disc's title appears.
2. Select the menu by pressing **▲▼◀▶**.
3. Press **▶** to confirm.

### 1.5 times speed playback

#### **DVD**

The 1.5 speed allows you to watch the pictures and listen to the sound quicker than playing at a normal speed.

1. During playback, press **▶** to play at 1.5 times speed. "▶X1.5" appears on the screen.
2. Press **▶** again to exit.

### Screen Saver

The screen saver appears when you leave the unit in Stop mode for about five minutes.

### Starting play from selected time

#### **DVD MOVIE**

To start playing at any chosen time on the file or title.

1. Press **INFO/DISPLAY** during playback.
2. Press **▲▼** to select the time clock icon and "--:--:--" appears.
3. Input the required start time in hours, minutes, and seconds from left to right. If you enter the wrong numbers, press **CLEAR** to remove the numbers you entered. Then input the correct numbers.  
For example, to find a scene at 1 hour, 10 minutes, and 20 seconds, enter "11020" by using numerical buttons.
4. Press **OK** to confirm. Playback starts from the selected time.

### Resume playback

#### **DVD MOVIE MUSIC ACD**

The unit records the point where you pressed the **■** depending on the disc.

If "||■" (Resume Stop) appears on the screen briefly, press **▶** to resume playback (from the scene point).

If you press **■** twice or unload the disc, "■" (Complete Stop) appears on the screen. The unit will clear the stopped point.

#### **Note**

- The resume point may be cleared when a button is pressed (for example; **⏻**, **⏮**, etc).
- This function may not work on some disc or title/track.

## Changing subtitle code page - Optional

### MOVIE

If the subtitle is not displayed properly, you can change the subtitle code page to view the subtitle file properly.

1. During playback, press **INFO/DISPLAY** to display the On-Screen display.
2. Use **▲▼** to select the [Code Page] option.
3. Use **◀>** to select desired code option.
4. Press **↶** **BACK** to exit the On-Screen display.

## Marked Playback

### MUSIC ACD

The mark function enables you to store your favourite files from any disc or USB device in the unit memory.

1. Select [Music] on the [Home Menu].

Returning to the upper folder.  
(MP3/ WMA only)

File information will be displayed according to the ID3TAG information on the appropriate music file. (MP3 only)

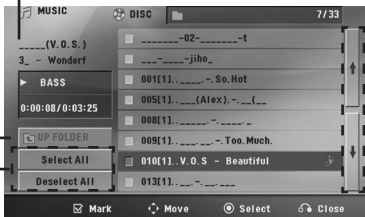

Selecting all tracks/ files.

Deselecting all tracks/files.

Moving to the previous or next file list.

2. Select a desired music on the [List] by using the **▲▼** then press **MARKER** to appear the mark on the list.
3. Press **OK** or **▶**.  
Displays the play mode.
4. Select the play mode by using the **▲▼** and press **OK**.

### [Mark Play]

Marked playback.

### [Current Play]

Normal playback.

### ! Note

If you want to select all files on the list, select [Select All] and press **OK**.

## To delete a Marker

1. Use **▲▼** to select the track that you wish to erase from the marked file.
2. Press **MARKER**.

## To delete all Markers

Use **▲▼<>** to select [Deselect All] then press **OK** in program edit mode.

### ! Note

The markers are also cleared when the disc or USB device is removed, the unit is switched to power off or the function is switched to others.

## Viewing a PHOTO file

### PHOTO

This unit can play discs with photo files.

1. Select [Photo] on the [Home Menu] and press **OK**.

Moving to the previous or next file list.

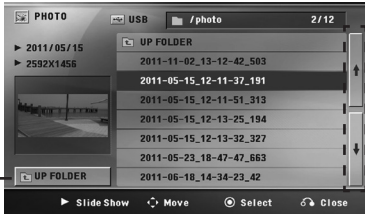

Returning to the upper folder.

2. Press **▲▼** to select a folder, and then press **OK**.
3. If you want to view a slide show, press **▲▼** to highlight a file and press **▶**.

### About help menu in the [Photo] menu

Menu	Buttons	Operation
▶ Slide Show	▶	Viewing a slide show.
▲▼◀▶ Move	▲▼<>	Moving to another file or content.
⊙ Select	⊙ OK	Viewing a particular file.
↶ Close	↶ BACK	Returning to the [Home Menu].

### About help menu in the full screen

Menu	Buttons	Operation
Menu	☐ INFO/DISPLAY	Displaying the Option menu.
◀/▶ Prev./ Next	</>	Moving to another file.
↶ List	↶ BACK	Returning to the [Photo] menu.

### Options while viewing a photo

You can use various options during viewing a photo in full screen.

1. While viewing a photo in full screen, press **☐ INFO/DISPLAY** to display the option menu.
2. Select an option using **▲▼<>**.



1. **Current photo/ Total number of photos** – Use **<>** to view previous/next photo.
2. **Slide Show ▶/||** – Press **OK** to start or pause slide show.
3. **Speed x3/ x2/ x1** – Use **OK** to select a delaying speed between photos in a slide show.
4. **Rotate** – Press **OK** to rotate the photo.
5. **Go to list** – Press **OK** to return [Photo] list.

## Other Operations

### Sleep Timer Setting

Press **SLEEP** one or more times to select delay time between 10 and 180 minutes, after the unit will turn off.

To check the remaining time, press **SLEEP**.

To cancel the sleep function, press **SLEEP** repeatedly until "SLEEP 10" appears, and then press **SLEEP** once again while "SLEEP 10" is displayed.

#### Note

- You can check the remaining time before the Unit turns off.
- Press **SLEEP** The remaining time appears in the display window.

### Dimmer

Press **SLEEP** once. The display window will be darken by half. To cancel it, press **SLEEP** repeatedly until dim off.

#### Note

All the LED turns off when Dimmer is being operated.

### Last Scene Memory

#### **DVD**

This unit memorizes last scene from the last disc that is viewed. The last scene remains in memory even if you remove the disc from the unit or switch off the unit. If you load a disc that has the scene memorized, the scene is automatically recalled.

### Power Resume - Optional

#### **DVD**

Even if the power suddenly goes out, turn on the unit and then it plays a position where the contents is being played. System will periodically save current playback status.

### System Select - Optional

You must select the appropriate system mode for your TV system. Press and hold **II** for more than five seconds to be able to select a system in the [Home Menu]. (NTSC ↔ PAL)

#### Note

If the USB device is connected or a disc is inserted, this function is not operated.

### Turn off the sound temporarily

Press  on the remote control to mute your sound.

You can mute your unit, for example, to answer the telephone, the "MUTE" will appear in the display window.

To cancel it, press  again or change the volume level.

## CHILDSAFE Mode

This function helps to prevent you from being surprised when you turn on the unit in case that the volume of the unit is set at a high level.

To turn on CHILDSAFE mode, press and hold **OK / SET** on the unit when the volume of the unit is "MIN".

In CHILDSAFE mode, the volume increase gradually.

To turn off CHILDSAFE mode, press and hold **OK / SET** on the unit when the volume of the unit is "MIN".

### ! Note

In case of DVD/CD, USB, BT function or LG TV Function, CHILDSAFE mode does not work after about 2 minutes from power on the unit even if this mode is enabled.

## VOICE CANCELLER

You can enjoy the function as karaoke, by reducing singer vocal of music in the various source. (MP3/ WMA/ CD/ etc.)

Press the **VOICE CANCELLER**, and "ON" will appear in display window.

To cancel it, press **VOICE CANCELLER** again.

The quality of the VOICE CANCELLER may be different depending on the recording conditions of music files.

### ! Note

- This function is available to use only when a microphone is connected.
- It is not available on the MONO source.

## DEMO

In the power off state, it demonstrates the function on display window and a display by pressing

**DEMO / REPEAT**.

To cancel the **DEMO / REPEAT**, press it again.

### ! Note

- While in DEMO, this unit will keep DEMO status even if you unplug the power cord connection.
- You can enjoy other functions during the DEMO, the DEMO will temporarily pause.
  - Without input key in 10 sec, the DEMO will play back automatically.

## Using Microphone

1. Connect your microphone to the MIC jack.
2. Play the music you want.
3. Sing along with the accompaniment. Adjust the microphone volume by rotating **MIC VOL** clockwise or counterclockwise on the unit or by pressing **MIC VOL -/+** on the remote control repeatedly.

### ! Note

- When not using the microphone, set the **MIC VOL** to minimum or turn off the MIC and remove the microphone from the MIC jack.
- If the microphone is set too near the speaker, a howling sound may be produced. In this case, move the microphone away from the speaker or decrease the sound level by using the **MIC VOL** on the unit or press **MIC VOL -** on the remote control. .
- If sound through the microphone is extremely loud, it may be distorted. In this case, rotate **MIC VOL** on the unit or press **MIC VOL -** on the remote control. to minimum.
- If your microphone's sound feels not loud though MIC VOL is max, you can adjust only audio source volume lower.
  - Follow below step.
    1. Press and hold **VOICE CANCELLER** on the unit.
    2. Reduce Audio Source Volume by rotating **MASTER VOLUME** counter-clockwise on the unit. To initialize it, power off or remove the microphone from the MIC jack.
- You can give an echo effect to the sound from the microphones by using the **ECHO VOL**.

## Setting the Clock

1. Turn the unit on.
2. Press and hold **CLOCK**.
3. Select time mode by rotating **MULTI CONTROL / TUNING** on the unit.
  - AM 12:00 (for an AM and PM display) or 0:00 (for a 24 hour display)
4. Press **OK / SET** to confirm your selection.
5. Select the hours by rotating **MULTI CONTROL / TUNING** on the unit.
6. Press **OK / SET**.
7. Select the minutes by rotating **MULTI CONTROL / TUNING** on the unit.
8. Press **OK / SET**.

## Using your player as an alarm clock

1. Turn the unit on.
2. Press and hold **ALARM**.
3. Rotate **MULTI CONTROL / TUNING** on the unit to change the hours and minutes and press **OK / SET** to save.
4. Rotate **MULTI CONTROL / TUNING** on the unit to select function and press **OK / SET** to save.
  - Press **◀◀/▶▶** on the remote control to select a memory No. when you select Tuner and then, press **OK / SET**.  
If there is no memory No., this step is skipped.
5. Rotate **MULTI CONTROL / TUNING** on the unit to change the volume and press **OK / SET** to save.

### Note

- If you set the clock time, you can check the time by pressing **CLOCK** even when the player is turned off.
- You can set alarm after you set the clock time.
- If you set the clock time and alarm, you can check the alarm setting information by pressing **ALARM** even when the unit is turned off.
- You can select **ALARM ON/OFF** mode by pressing **ALARM**.
- In case of DVD/CD or USB, this function is available when you have music file. If you do not have music file, the function is changed to Tuner.

## Auto power down

This unit will turn itself off to save electricity in the case where the main unit is not connected to an external device and is not used for 20 minutes. The unit will also turn itself off after six hours if the Main unit has been connected to another device using the analog inputs.

### How to disconnect the wireless network connection or the wireless device.

Turn off the unit by pressing the power button for more than 5 seconds.

## AUTO POWER On

This unit automatically turns on by an input source : LG TV or **Bluetooth**

If you try to connect your **Bluetooth** device, this unit turns on and connects your **Bluetooth** device. You can play your music.

### ! Note

- Depending on the connected device, this function may not operate.
- Depending on the connected device, the unit turns on but **Bluetooth** function may not be connected.
- If you disconnect **Bluetooth** connection by this unit, some **Bluetooth** devices try to connect to the unit continually. Therefore it is recommended to disconnect the connection before turning off the unit.
- If you turn on the unit using LG TV or **Bluetooth** function, proper function of this unit is turned on.
- If you have already paired with this unit, automatically this unit can turn on by an input source when this unit is turned off.
- If you turn off the unit by pressing the power button for more than 5 seconds, Auto Power On function is disabled. To activate it, turn on the unit.

## Auto function change

This unit recognizes input signals such as Bluetooth and LG TV and then changes suitable function automatically.

### When you try to connect Bluetooth device

When you try to connect your Bluetooth device to this unit, Bluetooth function is selected. Play your music on the Bluetooth device.

### When LG TV signal comes in

When you turn on your LG TV connected by LG Sound Sync, this unit changes the function to LG TV. You can hear the sound from your TV.

### ! Note

- This unit does not respond to the bluetooth connection signal while using the LG TV function.
- If you using the bluetooth function, this unit does not respond to LG TV connection signal.
- The bluetooth unit or the LG TV which is not paired with this unit, cannot use the auto function change.
- If you change the this unit's function to other function, some bluetooth unit may try to connecting in succession. Disconnect the bluetooth connection before changing of the this unit's function.

## LG Sound Sync



You can control some functions of this unit by your TV's remote control with LG Sound Sync. It is compatible with LG TV that supports LG Sound Sync. Make sure your TV has the LG Sound Sync logo.

Controllable function by LG TV's remote control :  
Volume up/down, mute

Refer to the TV's instruction manual for the details of LG Sound Sync.

1. Turn on the unit by pressing on the unit or on the remote control.
2. Press **F** on the unit or remote control until LG TV function is selected.
3. Set up the sound output of TV to listen to the sound through this unit :  
TV setting menu [Sound] -> [TV Sound output]  
-> [LG Sound Sync (Wireless)]  
"PAIRED" appears on the display window for about 3 seconds and then you can see "LG TV" on the display window if the TV and this unit are connected normally.

### ! Note

- You can also use the remote control of this unit while using LG Sound Sync. If you use TV's remote control again, the unit synchronizes with the TV.
- If the connection fails, check the conditions of this unit and your TV : power, function.
- Make sure of the condition of this unit and the connection in the cases below when using LG Sound Sync.
  - Turn off the unit.
  - Changing to a different function.
  - Disconnecting the wireless connection caused by interference or a distance.
- The amount of time to turn off this unit is different depending on your TV.
- Details of TV setting menu vary depending on the manufacturers or models of your TV.
- If you turned off the unit directly by pressing on the unit or on the remote control, LG Sound Sync will be disconnected. To use this function again, you should reconnect the TV and the unit.
- The volume may be increased when the TV and this unit is connected by LG Sound Sync. Decrease the TV volume and then connect with this unit.
- Bluetooth connection is unavailable after connecting LG TV.

# Troubleshooting

Problem	Cause & Solution
The unit does not work properly.	<ul style="list-style-type: none"> <li>• Turn off the power of this unit and the connected external device (TV, Woofer, DVD-player, Amplifier, etc.) and turn it on again.</li> <li>• Disconnect the power cord of this unit and the connected external device (TV, Woofer, DVD-player, Amplifier, etc.) and then try connecting again.</li> <li>• Previous setting may not be saved when device power is shut off.</li> </ul>
No Power.	<ul style="list-style-type: none"> <li>• The power cord is not plugged in. Plug in the power cord.</li> <li>• Check whether electricity failed. Check the condition by operating other electronic devices.</li> </ul>
No picture	<ul style="list-style-type: none"> <li>• Select the appropriate video input mode on the TV so the picture from the unit appears on the TV screen.</li> <li>• Connect the video cables securely to both the TV and unit.</li> </ul>
No sound.	<ul style="list-style-type: none"> <li>• Check whether you select right function. Press function button and check the selected function.</li> <li>• Check to see if the Speakers are connected correctly. Speaker cables connected correctly.</li> </ul>
The DVD picture quality is poor	<ul style="list-style-type: none"> <li>• Clean the disc using a soft cloth with outward strokes.</li> </ul>
A DVD/CD will not play	<ul style="list-style-type: none"> <li>• Insert a disc.</li> <li>• Insert a playable disc (check the disc type, colour system and regional code).</li> <li>• Place the disc with the label or printed side facing upwards.</li> <li>• Enter your password or change the rating level.</li> </ul>
Humming noise heard while a DVD or CD is playing	<ul style="list-style-type: none"> <li>• Clean the disc using a soft cloth with outward strokes.</li> <li>• Move unit further away from your TV.</li> </ul>
The unit does not start playback.	<ul style="list-style-type: none"> <li>• An unplayable disc is inserted. Check the playable disc.</li> <li>• No disc is inserted. Insert a disc.</li> <li>• The disc is dirty. Clean the disc. (Refer to page 44)</li> <li>• The disc is inserted upside down. Place the disc with the label or printed side facing upwards.</li> </ul>

Problem	Cause & Solution
Radio stations cannot be tuned in properly.	<ul style="list-style-type: none"> <li>• The antenna is positioned or connected poorly. Connect the antenna securely.</li> <li>• The signal strength of the radio station is too weak. Tune to the station manually.</li> <li>• No stations have been preset or preset stations have been cleared (when tuning by scanning preset channels). Preset some radio stations, see page 27 for details.</li> </ul>
The remote control does not work properly.	<ul style="list-style-type: none"> <li>• The remote control is too far from the unit. Operate the remote control within about 23 ft (7 m).</li> <li>• There is an obstacle in the path of the remote control and the unit. Remove the obstacle.</li> <li>• The batteries in the remote control are exhausted. Replace the batteries with new ones.</li> </ul>
LG Sound Sync does not work.	<ul style="list-style-type: none"> <li>• Check whether your LG TV supports LG Sound Sync.</li> <li>• Check connection of LG Sound Sync.</li> <li>• Check sound setting of your TV and this unit.</li> </ul>
The AUTO POWER function does not work.	<ul style="list-style-type: none"> <li>• Check connection of the external device such as TV or Bluetooth device.</li> <li>• Depending on the connected device, this function may not operate.</li> </ul>

## Controlling a TV with the Supplied Remote Control

You can control your TV using the buttons below.

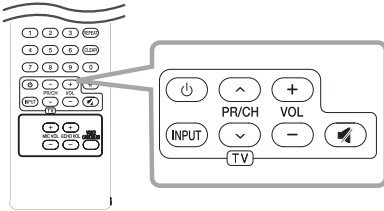

By pressing	You can
(TV POWER)	Turn the TV on or off.
INPUT	Switch the TV's input source between the TV and other input sources.
PR/CH	Scan up or down through memorized channels.
VOL +/-	Adjust the volume of the TV
(TV Mute)	Mutes the sound.

### Note

Depending on the unit being connected, you may not be able to control your TV using some of the buttons.

## Setting up the remote to control your TV

You can operate your TV with the supplied remote control.

If your TV is listed in the table below, set the appropriate manufacturer code.

1. While holding down (TV POWER) button, and press the manufacturer code for your TV with the numerical buttons (see the table below).

Manufacturer	Code Number
LG	1(Default), 2
Zenith	3, 4
GoldStar	1, 2
Samsung	6, 7
Sony	8, 9
Hitachi	4

2. Release the (TV POWER) button to complete setting.

Depending on your TV, some or all buttons may not function on the TV, even after entering the correct manufacturer code. When you replace the batteries of the remote, the code number you have set may be reset to the default setting. Set the appropriate code number again.

## Area Code List

Choose an area code from this list.

Area	Code	Area	Code	Area	Code	Area	Code
Afghanistan	AF	Fiji	FJ	Monaco	MC	Singapore	SG
Argentina	AR	Finland	FI	Mongolia	MN	Slovak Republic	SK
Australia	AU	France	FR	Morocco	MA	Slovenia	SI
Austria	AT	Germany	DE	Nepal	NP	South Africa	ZA
Belgium	BE	Great Britain	GB	Netherlands	NL	South Korea	KR
Bhutan	BT	Greece	GR	Antilles	AN	Spain	ES
Bolivia	BO	Greenland	GL	New Zealand	NZ	Sri Lanka	LK
Brazil	BR	Hong Kong	HK	Nigeria	NG	Sweden	SE
Cambodia	KH	Hungary	HU	Norway	NO	Switzerland	CH
Canada	CA	India	IN	Oman	OM	Taiwan	TW
Chile	CL	Indonesia	ID	Pakistan	PK	Thailand	TH
China	CN	Israel	IL	Panama	PA	Turkey	TR
Colombia	CO	Italy	IT	Paraguay	PY	Uganda	UG
Congo	CG	Jamaica	JM	Philippines	PH	Ukraine	UA
Costa Rica	CR	Japan	JP	Poland	PL	United States	US
Croatia	HR	Kenya	KE	Portugal	PT	Uruguay	UY
Czech Republic	CZ	Kuwait	KW	Romania	RO	Uzbekistan	UZ
Denmark	DK	Libya	LY	Russian Federation	RU	Vietnam	VN
Ecuador	EC	Luxembourg	LU	Saudi Arabia	SA	Zimbabwe	ZW
Egypt	EG	Malaysia	MY	Senegal	SN		
El Salvador	SV	Maldives	MV				
Ethiopia	ET	Mexico	MX				

## Language code List

Use this list to input your desired language for the following initial settings: [Disc Audio], [Disc Subtitle] and [Disc Menu].

Language	Code	Language	Code	Language	Code	Language	Code
Afar	6565	French	7082	Lithuanian	7684	Sindhi	8368
Afrikaans	6570	Frisian	7089	Macedonian	7775	Singhalese	8373
Albanian	8381	Galician	7176	Malagasy	7771	Slovak	8375
Ameharic	6577	Georgian	7565	Malay	7783	Slovenian	8376
Arabic	6582	German	6869	Malayalam	7776	Spanish	6983
Armenian	7289	Greek	6976	Maori	7773	Sudanese	8385
Assamese	6583	Greenlandic	7576	Marathi	7782	Swahili	8387
Aymara	6588	Guarani	7178	Moldavian	7779	Swedish	8386
Azerbaijani	6590	Gujarati	7185	Mongolian	7778	Tagalog	8476
Bashkir	6665	Hausa	7265	Nauru	7865	Tajik	8471
Basque	6985	Hebrew	7387	Nepali	7869	Tamil	8465
Bengali, Bangla	6678	Hindi	7273	Norwegian	7879	Telugu	8469
Bhutani	6890	Hungarian	7285	Oriya	7982	Thai	8472
Bihari	6672	Icelandic	7383	Panjabi	8065	Tonga	8479
Breton	6682	Indonesian	7378	Pashto, Pushto	8083	Turkish	8482
Bulgarian	6671	Interlingua	7365	Persian	7065	Turkmen	8475
Burmese	7789	Irish	7165	Polish	8076	Twi	8487
Byelorussian	6669	Italian	7384	Portuguese	8084	Ukrainian	8575
Chinese	9072	Japanese	7465	Quechua	8185	Urdu	8582
Croatian	7282	Kannada	7578	Rhaeto-Romance	8277	Uzbek	8590
Czech	6783	Kashmiri	7583	Rumanian	8279	Vietnamese	8673
Danish	6865	Kazakh	7575	Russian	8285	Volapük	8679
Dutch	7876	Kirghiz	7589	Samoan	8377	Welsh	6789
English	6978	Korean	7579	Sanskrit	8365	Wolof	8779
Esperanto	6979	Kurdish	7585	Scots Gaelic	7168	Xhosa	8872
Estonian	6984	Laothian	7679	Serbian	8382	Yiddish	7473
Faroese	7079	Latin	7665	Serbo-Croatian	8372	Yoruba	8979
Fiji	7074	Latvian, Lettish	7686	Shona	8378	Zulu	9085
Finnish	7073	Lingala	7678				

## Trademarks and Licenses

All other trademarks are trademarks of their respective owners.



Manufactured under license from Dolby Laboratories. Dolby and the double-D symbol are trademarks of Dolby Laboratories.



The terms HDMI and HDMI High-Definition Multimedia Interface, and the HDMI logo are trademarks or registered trademarks of HDMI Licensing LLC in the United States and other countries.



"DVD Logo" is a trademark of DVD Format/Logo Licensing Corporation.



The **Bluetooth**® word mark and logos are registered trademarks owned by the Bluetooth SIG, Inc. and any use of such marks by LG Electronics is under license. Other trademarks and trade names are those of their respective owners.

---

## Notes on Copyrights

- This product incorporates copyright protection technology that is protected by U.S. patents and other intellectual property rights. Use of this copyright protection technology must be authorized by Rovi, and is intended for home and other limited viewing uses only unless otherwise authorized by Rovi. Reverse engineering or disassembly is prohibited.
- Under the U.S. Copyright laws and Copyright laws of other countries, unauthorized recording, use, display, distribution, or revision of television programs, videotapes, BD-ROM discs, DVDs, CDs and other materials may subject you to civil and/or criminal liability.

## Maintenance

### Notes on Discs

#### Handling Discs

Do not touch the playback side of the disc. Hold the disc by the edges so that fingerprints do not get on the surface. Never stick paper or tape on the disc.

#### Storing Discs

After playing, store the disc in its case. Do not expose the disc to direct sunlight or sources of heat and never leave it in a parked car exposed to direct sunlight.

#### Cleaning Discs

Fingerprints and dust on the disc can cause poor picture quality and sound distortion. Before playing, clean the disc with a clean cloth. Wipe the disc from the center to out.

Do not use strong solvents such as alcohol, benzene, thinner, commercially available cleaners, or anti-static spray intended for old vinyl records.

### Handling the Unit

#### When shipping the unit

Please save the original shipping carton and packing materials. If you need to ship the unit, for maximum protection, re-pack the unit as it was originally packed at the factory.

#### Keeping the exterior surfaces clean

Do not use volatile liquids such as insecticide spray near the unit. Wiping with strong pressure may damage the surface. Do not leave rubber or plastic products in contact with the unit for a long period of time.

#### Cleaning the unit

To clean the player, use a soft, dry cloth. If the surfaces are extremely dirty, use a soft cloth lightly moistened with a mild detergent solution. Do not use strong solvents such as alcohol, benzene, or thinner, as these might damage the surface of the unit.

#### Maintaining the Unit

The unit is a high-tech, precision device. If the optical pick-up lens and disc drive parts are dirty or worn, the picture quality could be diminished. For details, please contact your nearest authorized service center.

## General specifications

General	
Power requirements	Refer to the main label on the unit.
Power consumption	Refer to the main label on the unit.
	Networked standby : 0.5 W (If all network ports are activated.)
Dimensions (W x H x D)	450 mm x 160 mm x 355 mm
Operating temperature	5 °C to 35 °C (41 °F to 95 °F)
Operating humidity	65 %

Inputs / Outputs	
HDMI OUT (video/audio)	19 pin (Type A, HDMI™ Connector)
Analog audio out (AUX OUT)	2,0 Vrms (1 kHz, 0 dB), 600 Ω, RCA jack (L, R)
Analog audio in (AUX IN)	2,0 Vrms (1 kHz, 0 dB), 600 Ω, RCA jack (L, R)
Portable in (PORT. IN)	1.2 Vrms (3.5 mm stereo jack) x 1
Microphone (MIC 1/2)	Sensitivity 20 mV (1 kHz), 6.3 mm jack x 2

Tuner	
FM Tuning Range	87,5 to 108.0 MHz or 87,50 to 108,00 MHz

System	
Frequency Response	40 to 20,000 Hz
Signal-to-noise ratio	More than 75 dB
Dynamic range	More than 80 dB
Bus Power Supply (USB)	5 V  500 mA

Amplifier (RMS Output power)	
Total output	1,100 W
FRONT	550 W X 2 (6 Ω at 1 khz, 25 % THD)

- Design and specifications are subject to change without notice.

## Speakers specifications

Front speaker	
Type	3 Way 3 Speaker
Impedance	6 $\Omega$
Rated Input power	550W
Max. Input power	1110W
Net Dimensions (W x H x D)	321 mm x 454 mm x 301 mm

- Design and specifications are subject to change without notice.

