



OWNER'S MANUAL

# AIR PURIFIER

**Read this owner's manual thoroughly before operating the appliance and keep it handy for reference at all times.**

Model name: AS95GD Series



MFL69726873  
Rev.01\_022720

[www.lg.com](http://www.lg.com)  
Copyright © 2020 LG Electronics. All Rights Reserved.



# Table of Contents

This manual is produced for a group of products and may contain images or content different from the model you purchased. This manual is subject to revision by the manufacturer.

**Safety Instructions .....04**

**Unpacking..... 10**

- Parts..... 10
- Removing Packing Materials..... 11
- Remote Control Setup..... 13

**Installation ..... 14**

- Transporting or Moving the Product..... 14
- Installing the Product..... 14

**Operation ..... 15**

- Product Overview ..... 15
- Getting Started..... 21
- Using Smart Mode..... 21
- Using Booster Mode ..... 22
- Using Dual Mode ..... 22
- Using Single Mode ..... 23
- Adjusting the Fan Speed ..... 23
- Adjusting the Clean Booster Fan Speed ..... 24
- Rotating the Clean Booster ..... 24
- Checking the Air Quality ..... 25
- Using the Air Ionizer ..... 28
- Setting the Sleep Timer ..... 28
- Locking the Control Panel Buttons..... 29

**Smart Functions.....30**

- LG ThinQ Application..... 30
- Smart Diagnosis ..... 32

**Maintenance ..... 33**

- Cleaning the Exterior ..... 34
- Cleaning the Filter ..... 35
- Replacing the Filter..... 35
- Cleaning the Dust Sensor ..... 36
- Storage ..... 37

**Before Calling for Service..... 38**

**Product Specifications..... 42**

# Safety Instructions

## READ THESE INSTRUCTIONS CAREFULLY

This guide contains many important safety messages. Always read and obey all safety messages.

 This is the safety alert symbol. It alerts you to safety messages that inform you of hazards that can kill or hurt you or others, or cause damage to the product.

All safety messages will be preceded by the safety alert symbol and the hazard signal word WARNING or CAUTION. These words mean:

 **WARNING** - You can be killed or seriously injured if you do not follow these instructions.

 **CAUTION** - Indicates an imminently hazardous situation which, if not avoided, may result in minor or moderate injury or product damage.

This equipment is home (class B) EMI suitable equipment, which is mainly for home use, and it can be used in all regions.

### Warning

To reduce the risk of fire, electric shock or personal injury when using this product, follow basic safety precautions including the following:

## CHILDREN IN THE HOUSEHOLD

This appliance is not intended for use by persons (including children) with reduced physical, sensory or mental capabilities or lack of experience and knowledge, unless they have been given supervision or instruction concerning use of the appliance by a person responsible for their safety. Children should be supervised to ensure that they do not play with the appliance.

## INSTALLATION

- Install the product near an easily accessible electrical outlet.
- Do not install the product on an uneven or inclined surface.
- Do not install the product in a damp area and keep away from splashing rain or water.

- Do not install the product in an area exposed to direct sunlight or near heat-generating equipment.
- Do not install the product in a place where combustible gas may leak or industrial oil or metallic particulates are present.

## **POWER**

- This product is for AC 220–240 V. Always check the supply voltage before using it.
- Be careful not to let the power plug pressed by the back of the product.
- Remove the power plug when you clean the product or replace the filter.
- Do not touch the power plug with wet hands.
- Insert the plug into the outlet tightly after removing the moisture and dust on it completely.
- When unplugging the power cord, always pull it by the plug.
- Unplug the product during thunder or lightning or when not in use for a long time.
- Do not bend the power cable excessively or place a heavy object on top of it.
- Do not extend the length of the power cable or alter it.
- Do not use several devices on a multi-socket extension outlet.
- The appliance shall be disconnected from its power source during service and when replacing parts.
- Take care to ensure that power cable could not be pulled out or damaged during operation. There is risk of fire or electric shock.

- If the supply cord is damaged, it must be replaced by the manufacturer, its service agent or similarly qualified person using only genuine replacement parts in order to avoid a hazard.

## **USE**

- If the product is immersed in water, stop using it and contact the LG Electronics service center.
- If there is a gas leakage (isobutane, propane, LNG, etc.), do not touch the product or power plug and ventilate the area immediately.
- Do not clean the product with brushes, cloths or sponges with rough surfaces or which are made of metallic material.
- If you detect any abnormal noise, odor or smoke, unplug the product immediately and contact an LG Electronics service center.
- Only an authorized repair person from LG Electronics service center should disassemble, repair, or modify the product.
- Do not use or store fire, combustibles (ether, benzene, alcohol, drugs, propane, butane, combustible spray, insecticide, air freshener, cosmetics etc.) or flammable materials (candles, lamps etc.) near the product.
- Do not place the power cord under rugs, carpeting or mats.
- Do not allow animals or pets to chew on the power cord.
- Do not allow children to climb on or play with the product.
- Do not move the product when it is in operation.
- Do not place coffee, flower vase or drinks on top of the product.
- Do not insert hands or metal objects into the air inlet or outlet.
- Do not impact the product.

- Be careful not to allow any part of your body to be pinched when you detach and re-attach parts of the product.
- Unplug the product when not in use for a long time.
- Do not install and use broken parts.
- Do not clean the product when it is plugged in.
- Do not put flammables into the product.
- Do not operate the product while its cover is open.

## **DISPOSAL**

- Dispose of the packing materials (vinyl, styrofoam etc.) to keep them out of reach of children.

## **Caution**

To reduce the risk of fire, electric shock, or personal injury when using the product, follow basic safety precautions, including the following:

### **INSTALLATION**

- Do not tilt the product to pull or push it while transporting.
- Do not install the product in transportation equipment (vehicle/vessel etc.).
- Do not place the product near a TV or a stereo equipment.
- Do not place the product under bright light.
- The appliance shall be installed in accordance with national wiring regulations.

### **USAGE**

- Do not use the product for removal of toxic gas such as carbon monoxide.
- Do not use the product for ventilation purposes.
- Do not use the product for a long time in a region with unstable voltage.
- Do not place obstacles around the air inlet or outlet.
- For safe use of the product, children or others with reduced mental capabilities need to be closely monitored by a person who is responsible for their safety.
- Do not place the product near curtains.
- Do not use the product for special purposes such as preserving plants, precision instrument, artworks etc.
- Do not climb or place objects on top of the product.

- Do not operate the product with wet hands.
- Do not let the moisture from the humidifier directly touch the product.
- Do not use the product while it is not in upright position.
- Do not use the product near objects vulnerable to heat.
- Use the filter only for its intended purpose.
- Do not use detergents, cosmetics, chemicals, air fresheners, or disinfectants in the product.
- Do not place magnetic or metal objects on top of the product.
- Do not clean with strong detergents of solvent types, but use soft cloth.
- Do not operate the Booster arbitrarily.
- Do not insert any objects into the Booster.
- Do not operate the product while the Booster cover and grill are separated.
- Do not insert hands or metal objects into the Booster.

# Unpacking

## Parts

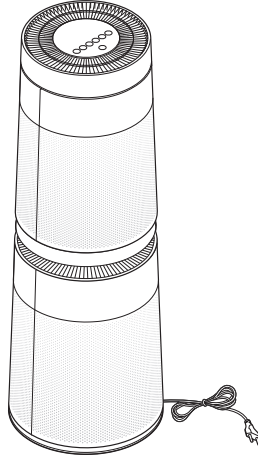

Air Purifier

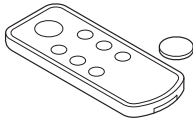

Remote Control /  
Battery (CR2025, 1 Unit)

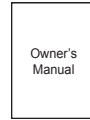

Owner's Manual

- The appearance or components of the product may differ depending on the model.
- The shape of the power plug differs depending on the country.

# Removing Packing Materials

Unpack the product and remove any packing tape or protective vinyl before using the product.

- 1** Pull out the product from the packaging and remove the fixing tape attached on the product.
- 2** Grab the top end of the back cover and gently pull it.
  - You will see "PM 1.0 & GAS SENSOR SYSTEM" on the back cover of the product.

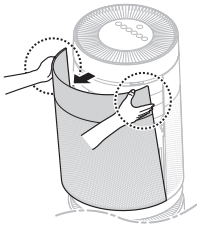

- 3** Remove the cover from the product.

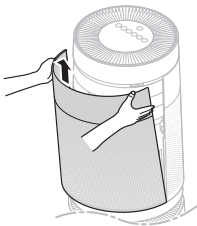

- 4** Remove the support located at the filter inlet.
  - Upper filter inlet: 1 support
  - Lower filter inlet: 1 support

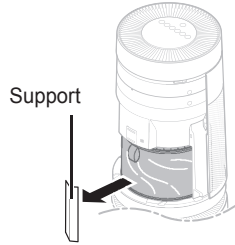

- 5** Remove the filter and its protective vinyl.

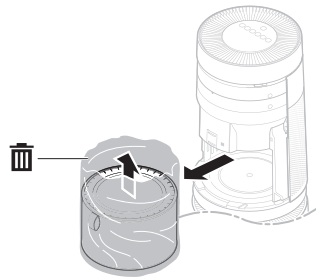

- 6** Install the filter in the product.
  - Make sure that the handle faces upward.

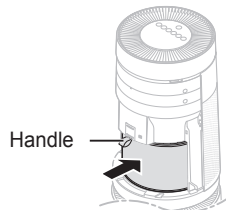

- 7** Insert the fixing parts at the bottom of the cover into the holes at the bottom of the product before you close the cover.

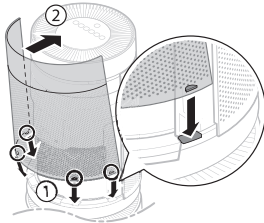

- 8** Remove the protective vinyl from the filter at the lower part of the product in the same way.

**⚠ Caution**

- Failure to remove the supports may affect the performance of the product. Please be sure to remove it before use.
- Make sure that you remove the filter's protective vinyl prior to use otherwise it may result in product malfunction.
- Pay attention to the direction of the filter when you install the filter otherwise it may cause malfunction or failure of the product.

## Remote Control Setup

- 1 With the backside of the remote controller facing up, remove the battery tray from the remote control.



- 2 Insert the battery provided with the product to the tray.
  - The (+) electrode of the battery must face upward.

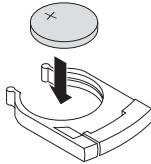

- 3 Insert the battery tray to the remote control.

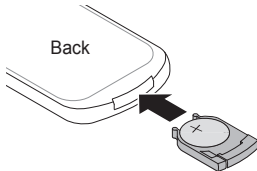

### Warning

- A button/coin-shaped battery is used in the remote control of the product.
- Do not swallow the battery. It may cause injury, including damage to the internal organs or death.
- If you accidentally swallowed the battery, go to the doctor immediately for emergency treatment. If you fail to receive first aid within 2 hours after you swallowed it, you may experience damage to your internal organs or death in severe cases.
- Keep the battery out of reach of children.
- If the battery tray is not secured firmly, stop using the product instantly and keep it away from children.

### Caution

- Do not modify the battery arbitrarily. It may cause a fire or electric shock.
- Misplaced battery may cause an explosion.
- Do not recharge or take apart the battery. It may result in explosion.
- Do not throw the battery in the fire for disposal or leave it near the heat. It may result in explosion.

### Note

- If the battery runs out of charge, replace it with a new one (CR2025).
- If the remote control does not work as expected, try to replace the battery or check the polarity (+, -) of the battery. If the problem continues, contact the Service Center.
- Dispose of the used battery according to the environmental regulations.

# Installation

## Transporting or Moving the Product

### ⚠ Caution

Transport the product in a well-secured and upright position. Impacts may cause product damage.



The product is heavy. Use two people when moving it.

- Dropping the product may cause personal injury or product malfunction.
- Do not hold the outer cover when you carry the product. The cover may open accidentally, causing the product to drop.

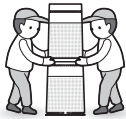

When moving or storing the product, wrap the power cord around the base of the product to prevent personal injury, damage to the cord or damage to floors.



## Installing the Product

### ⚠ Caution

Install the product on a strong level surface. Installing the product on a weak or tilted surface may cause noise and vibration or tipping, resulting in injury.

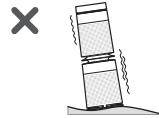

Allow a 1 m clearance between the product and surrounding surfaces or objects. The air inlet needs space to function properly.

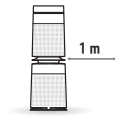

Do not install the product near curtains which could block the air inlet or outlet. Doing so may result in product malfunction or failure.

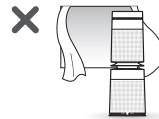

The performance of the product may differ depending on the operating environment (such as temperature and humidity).

- 40 – 70 % of humidity is recommended for optimal performance.



# Operation

## Product Overview

### Front View

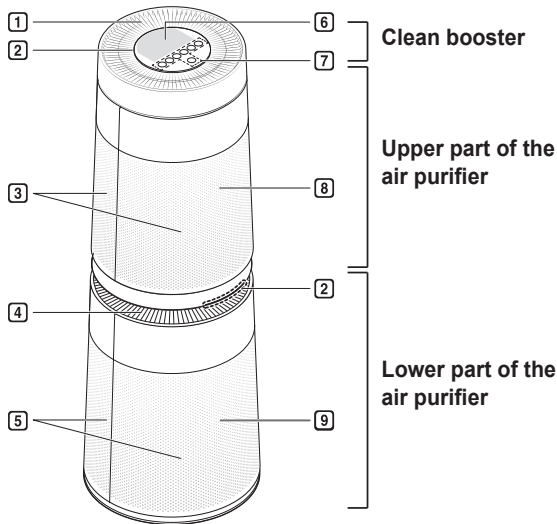

#### 1 Upper air outlet/Clean booster

- It discharges purified air through the upper filter.
- You can control the direction of the air so that it reaches every corner of the room.

#### 2 Light Lamp

It displays the overall air quality using a colored light.

#### 3 Upper air inlet (top cover)

- Air goes into the upper part of the purifier through the inlet. You may remove the front or rear cover separately.

#### 4 Lower air outlet

It discharges purified air through the lower filter.

#### 5 Lower air inlet (bottom cover)

- Air goes into the lower part of the purifier through the inlet. You may remove the front or rear cover separately.

#### 6 Status Panel

Use it to check the settings of the product and the air quality.

#### 7 Control Panel

Use it to set the product functions.

#### 8 Receiver for Remote Control Signal

#### 9 Air Ionizer

- It generates negative ions and removes harmful bacteria in the air.
- It is built in the lower part of the air purifier.

- The appearance or components of the product may differ depending on the model.

## Back View

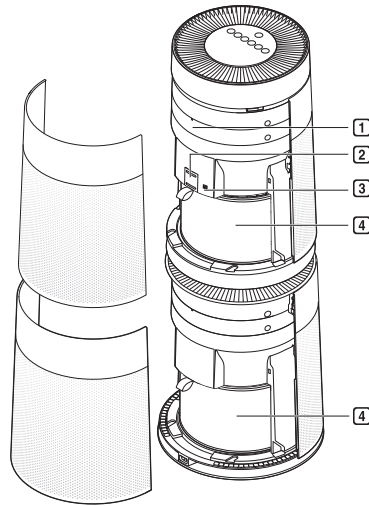

**1 Smart Diagnosis Part**

In the event of a malfunction or failure, you can use the Smart Diagnosis option to check the product condition. (See **Smart Functions**.)

**2 PM 1.0 (super ultra-fine dust) sensor**

It detects the concentration of dust.

**3 Smell (Gas) Sensor**

It detects a smell (gas).

**4 Filter**

It removes allergic materials, yellow dust/ultra-fine dust, possible sources of sick house syndrome, smog and other odor.

## Filter System

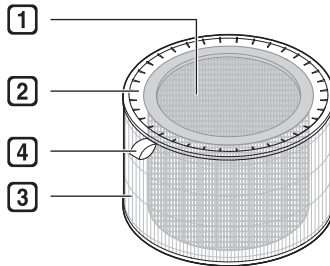

### 1 Total Harmful Gas Care Filter

It removes harmful smells (gas) that are generated in everyday life such as bathroom smell, cigarette smoke (smell) and food smell.

### 2 Total Allergen Collection Care Filter

It removes super ultra-fine dust, yellow dust and cigarette smoke particles from the air.

### 3 Ultra-fine Filter

It is attached on the exterior of the Total Allergen Collection Care Filter, primarily removing large particles floating in the air, including pet hair.

### 4 Filter Handle

Use it to separate the filter from the product.

### ⚠ Caution

- The Total Harmful Gas Care Filter and Total Allergen Collection Care Filter are assembled together. Do not try to detach them from each other.
- Do not throw the filter or use it for other purposes.

### Note

- Keep the windows or doors closed while using the product. However, if you operate the product for a long time in a closed space, carbon dioxide concentration may rise. So be sure to ventilate the indoor air regularly.
- Carbon monoxide (CO) is a harmful gas that is mainly introduced from outside and cannot be removed with a filter.
- The deodorization function of the air purifier operates by trapping the smell (gas) in the filter. If you use the product for a long time in a room with excessive smell, the performance of the filter may drop significantly. The Total Harmful Gas Care Filter may sometimes become the source of excessive smell if used for a long time in a room with excessive smell.
- If excessive smell is present in the room, first ventilate the indoor air to remove the smell. Then use the air purifier to remove the remaining smell.

## Control Panel

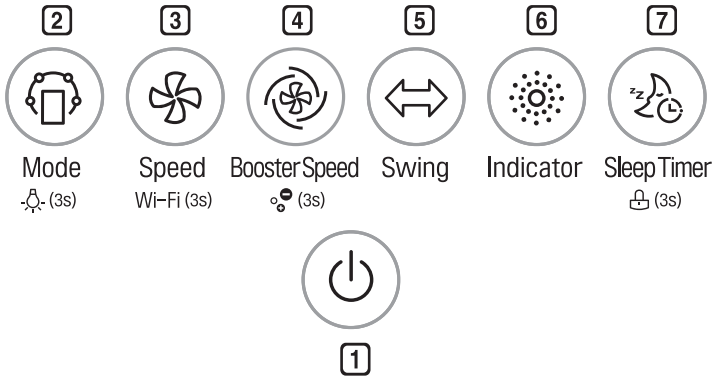

### 1 Start/Stop Button

You can start or stop the operation.

### 2 Mode Button

Use it to set the operation mode.

- Press and hold the button for 3 seconds or more to turn on/off the Light lamp. (See **Turning on/off the Light Lamp.**)

### 3 Speed Button

It allows you to adjust the wind strength of the product.

- Press and hold the button for more than 3 seconds to activate the Wi-Fi registration mode.
- **Turning off Wi-Fi**  
Press and hold the **Start/Stop** button and the **Speed** button at the same time for more than 3 seconds to turn off Wi-Fi.  
After finishing the product registration and while Wi-Fi is off, press and hold the **Speed** button for more than 3 seconds just once to turn on Wi-Fi and to control the product using the registered smart phone.

### 4 Booster Speed Button

It allows you to adjust the wind strength of the clean booster.

- Press and hold it for 3 seconds or more to turn on or off the ionizer. (See **Using the Air Ionizer.**)

### 5 Swing Button

It allows you to set the clean booster to turn left or right.

### 6 Indicator Button

You can check the concentration of the airborne dust by its particle size.

### 7 Sleep Timer Button

Use it to schedule the time to turn off the product.

- Press and hold it for 3 seconds or more to lock or unlock the Control Panel buttons. (See **Locking the Control Panel Buttons.**)

## Status Display Panel

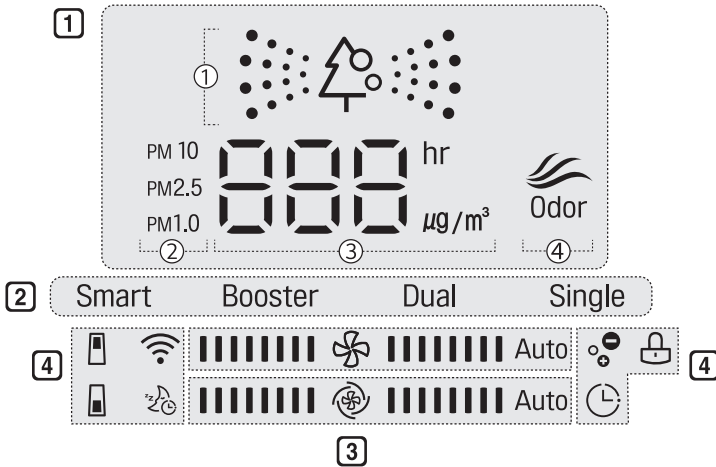



### 1 Display of air quality







- ① Overall air quality (color)
- ② Dust particle size and dust concentration (color)
- ③ Dust concentration or sleep timer time
- ④ Smell concentration (color)

### 2 Displays operating mode

### 3 Displays speed and booster speed

-  Speed: Displays the air purifier's wind strength.
-  Booster Speed: Displays the clean booster's wind strength.

### 4 Icons

Icon	Description
	It turns on when it is time to replace the upper filter.
	It turns on when it is time to replace the lower filter.
	It turns on when the Wi-Fi function is activated.
	It turns on when the sleep timer function is activated.
	It turns on when the 'On/Off Reservation' is set in the LG ThinQ application.
	It turns on when the control panel is locked.
	It turns on when the ionizer turns on.

## Remote Control

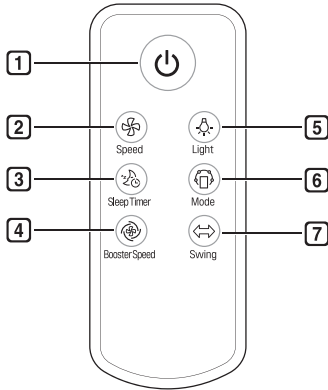

### 1 Start/Stop Button

You can start or stop the operation.

### 2 Speed Button

It allows you to adjust the wind strength of the product.

### 3 Sleep Timer Button

Use it to schedule the time to turn off the product.

### 4 Booster Speed Button

It allows you to adjust the wind strength of the clean booster.

### 5 Light Button

Use it to turn on or off the Light Lamp.

### 6 Mode Button

Use it to set the operation mode.

### 7 Swing Button

It allows you to set the clean booster to turn left or right.

### Caution

- Do not press multiple buttons at the same time. It may cause the product to stop operating or malfunction.
- Do not kick or step on the remote control. It may result in damage.
- Do not use it where there is too much water or moisture. It may result in fire or electric shock.
- Do not use it where there is fire or heat. It may result in a fire or product deformation.
- Remove and store the battery in a safe location if you don't intend to use the remote control for a long time. It may result in leakage of the battery liquid and lead to a failure.

### Note

- To use the remote control, direct the signal sending area of the remote control toward the signal reception area of the product.
- If you are away from the product (front) by more than 7 m, the remote control may not work.
- If the remote control does not work even after replacing the battery, contact the nearest service center.
- The remote control may not work properly where there is a strong light, such as those from a 3-wavelength fluorescent lamp or a neon sign.
- If you lost the remote control, you can purchase a new one in a nearby service center.

## Getting Started

Press the **Start/Stop** button to start the operation.

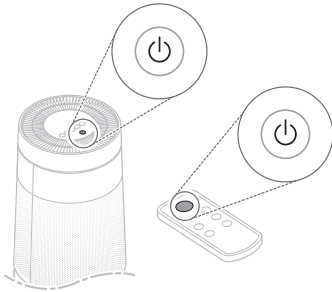

### Note

- If you operate the product for the first time, it enters **Booster** mode.
- If you stop and resume the operation, it starts cleaning with the mode you selected last time. Even if power is lost due to a blackout, the product remembers the mode you used last time.
- Once the operation starts, the sensor stabilizes (for approx. 30 seconds) before the dust concentration is displayed. During the sensor stabilization period, you will see  (ready) on the status panel. You can specify the sensor stabilization time in the 'Air Quality Sensor Operation Time' option in the LG ThinQ application.
  - 'Always On': The sensor stabilization turns on only once at the beginning.
  - 'Only During Operation': The sensor stabilization turns on every time you start/stop the operation.

## Using Smart Mode

It automatically controls the operation mode and wind strength based on the overall air quality.

Press **Mode** button to choose **Smart** mode.

- Each time you press the button, the operation mode changes in the following order: **Smart** → **Booster** → **Dual** → **Single**.

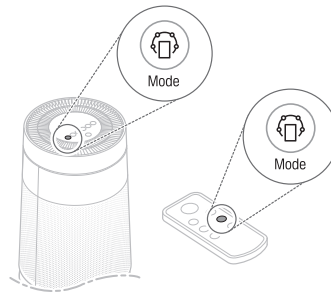

### Note

- While in **Smart** mode, the **Speed**, **Boost Speed** and **Swing** buttons do not work.
- **Smart** mode operates either the clean booster, upper purifier or lower purifier to adapt to the air quality.

## Using Booster Mode

The clean booster cleans the air and quickly sends it to a long distances to circulate the indoor air.

Press the **Mode** button to choose **Booster** mode.

- Each time you press the button, the operation mode changes in the following order: **Smart** → **Booster** → **Dual** → **Single**.

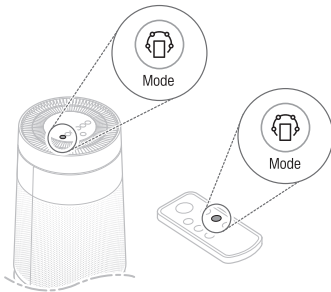

## Using Dual Mode

It uses both the upper part and lower part of the purifier simultaneously to quickly clean the indoor air.

Press the **Mode** button to choose **Dual** mode.

- Each time you press the button, the operation mode changes in the following order: **Smart** → **Booster** → **Dual** → **Single**.

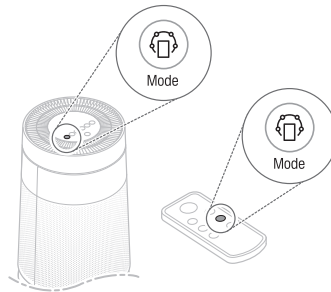

### **Caution**

Keep your hands out of the moving part of the clean booster.

### **Note**

- If you choose **Booster** mode, the clean booster rises at the degree of 55 and pushes the air forward to circulate the indoor air.
- For more information on how to control the wind strength of the clean booster, see **Adjusting the Clean Booster Fan Speed**.
- To rotate the clean booster left and right, see **Rotating the Clean Booster**.
- If you happen to unplug the power cord from the outlet before the Clean Booster closes completely, plug in the cord again. The Clean Booster will swing left and right and then close completely.

## Using Single Mode

It cleans the indoor air using the lower part of the purifier.

Press the **Mode** button to choose **Single** mode.

- Each time you press the button, the operation mode changes in the following order: **Smart** → **Booster** → **Dual** → **Single**.

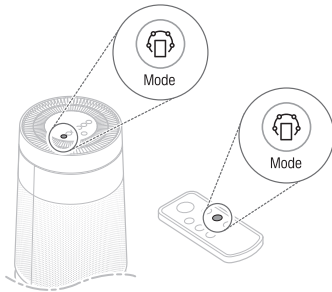

### Note

The upper part of the purifier runs with gentle wind for optimal performance.

## Adjusting the Fan Speed

You can adjust the wind amount of the purifier.

Press the **Speed** button during the operation.

- Each time you press the button, the speed changes in the following order: **Auto** → **Low** → **Middle** → **High** → **Turbo**.

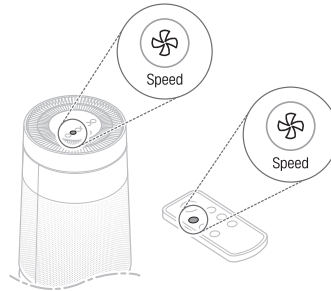

## Displaying Purifier Speed

If you adjust the speed, it is displayed on the status panel. It increases by 2 grids at a time.

[Example of Purifier Speed 'Middle']



### Note

- The speed is set to **Auto** when you first start the operation. **Auto** mode controls the wind speed automatically according to the contamination level of the indoor air.
- You can control the wind speed only in the **Booster**, **Dual**, and **Single** modes.

## Adjusting the Clean Booster Fan Speed

You can adjust the wind amount of the clean booster.

While in **Booster** mode, press the **Booster Speed** button.

- Each time you press the button, the speed changes in the following order: Auto → Low → Middle → High → Turbo.

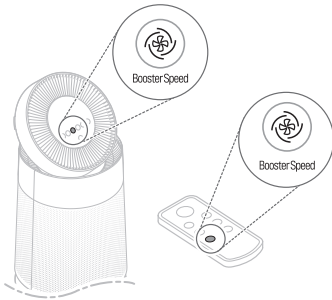

## Displaying Booster Speed

If you adjust the booster fan speed, it is displayed on the status panel. It increases by 2 grids at a time.

[Example of Booster Speed 'Middle']



### Note

- If you choose **Auto**, the fan inside the clean booster is adjusted according to the speed of the purifier. For example, if you change the speed of the purifier to 'Low', the booster fan speed is changed to 'Low' as well.
- You may control the booster fan speed only in **Booster** mode. In the other modes, you will hear a warning sound and won't be able to control the function.

## Rotating the Clean Booster

The clean booster rotates left and right.

While in **Booster** mode, press the **Swing** button.

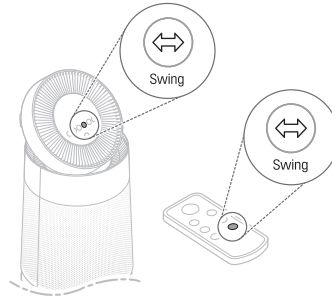

### ! Caution

Keep your hands out of the moving part of the clean booster.

### Note

- The rotating angle of the clean booster is 35°.
- You may use the clean booster rotation function only in **Booster** mode. In the other modes, you will hear a warning sound and won't be able to control the function.

# Checking the Air Quality

You can check the cleanliness of the indoor air by looking at the Light lamp and the status panel.

## Understanding the Overall Air Quality

The overall air quality is calculated based on the dust and smell (gas) concentrations and is categorized into 4 levels including green, yellow, orange or red depending on the contamination of the air.

Overall Air Quality	State	PM density ( $\mu\text{g}/\text{m}^3$ )			Odor Level	
		PM10 (fine dust)	PM2.5 (ultra fine dust)	PM1.0 (super ultra fine dust)	State	Level
Red	Poor	255 or more	56 or more	56 or more	Very strong	4
Orange	Unhealthy	155~254	36~55	36~55	Strong	3
Yellow	Moderate	55~154	13~35	13~35	Normal	2
Green	Good	54 or less	12 or less	12 or less	Weak	1

- Overall air quality can be determined based on the Light lamp and the  color (overall air quality) on the status panel.
- The color of overall air quality is determined based on whichever is worse between the dust concentration and smell (gas) concentration.

## Checking the Air Quality Using the Light Lamp

Four different colors are used to indicate the overall air quality based on the dust concentration and smell (gas) concentration.

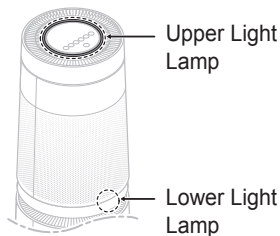

### Note

The Light lamp turns on white for the sensor stabilization period (30 seconds). The smell (gas) sensor is stabilized 2 minutes after you start the operation. During this period, the smell (gas) concentration is not reflected in the overall air quality.

## Turning on/off the Light Lamp

You can press and hold the **Mode** button for 3 seconds or more to turn it on/off.

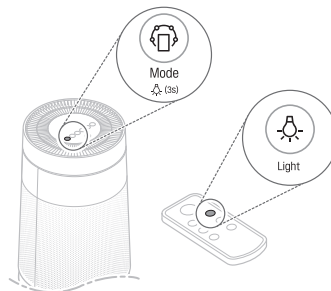



### Note

- When the sleep timer is set, the Light lamp turns off.
- If you turn on the Light lamp after setting the sleep timer, you will see the overall air quality on the status panel as well as on the Light lamps.

## Checking Air Quality on the Status Panel



You may check the overall air quality, dust concentration, and smell concentration on the status panel.

- **Overall air quality:** You can check the  color (overall air quality) on the status panel to determine the overall air quality.
- **Dust concentration:** You can check the dust concentration by looking at the dust concentration value and the particle size indicator color. It shows the worst status among the PM 10 (fine) / PM 2.5 (ultra-fine) / PM 1.0 (super ultra-fine dust).
  - If the dust concentrations of all categories are 'good', the concentration of the 'PM 10' is displayed.
  - If it is worse than 'moderate', the color and concentration of the dust with the highest contamination level are displayed. If they share the same contamination level, the contamination level is displayed according to the following order: PM 1.0, PM 2.5 and PM 10.
- **Smell concentration:** You can check the  color (smell concentration) on the status panel to determine the smell concentration.

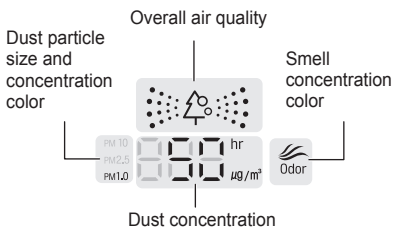
### [Example of the Display Showing Air Quality]



The above picture displays **PM10/PM2.5/PM1.0**, meaning that the concentration of super ultra-fine dust is higher than those of fine dust and ultra-fine dust.

While the color of the dust particle size is solely determined based on the dust concentration and the color of the  (smell concentration) is solely determined based on the smell concentration, the color of the  (overall air quality) is determined based on the worse cause between the dust and smell.

If the smell is 'normal' and the PM 1.0 (super ultra-fine dust) concentration is **50 μg/m<sup>3</sup>**, which is 'unhealthy', the overall air quality is displayed in orange as the worst cause is the dust. On the other hand, if the smell is 'very strong', the overall air quality is displayed in red because the smell becomes the worst cause.

## Checking the Dust Concentration

You can check the airborne dust concentration by its particle size.

Press the **Indicator** button during the operation.

- Whenever you press the button, the display changes in the following order: **PM10** → **PM2.5** → **PM1.0**.
- The concentration of the selected dust particle is displayed for about 10 seconds.

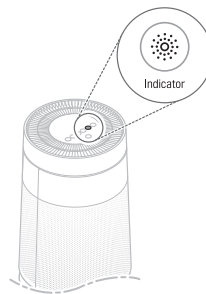

## Note

- PM (particulate matter) density is displayed in increments of 1 unit, from 8 to 999. PM density values are based on the data sheet provided by the sensor manufacturer.
- The PM10 and PM2.5 air quality values follow those provided by the United States EPA (Environmental Protection Agency) for 2015.
  - The overall air quality level displayed on the product may differ from the level announced by the EPA.
- The PM1.0 density is displayed in the same manner as the PM2.5 density and is based on LG Electronics standards.
- The PM10 and PM2.5 densities displayed by the product could differ from the EPA forecast and from densities measured by other products or devices.
  - Differences in PM density values may be the result of different methods of measuring or differences in the actual PM density levels.
  - The PM density measurement was tested using LG Electronics' standard test materials.
- Using the product near a humidifier, mist generator, air-conditioner or other device which generates steam or micro-particles could affect the PM densities.
- The overall air quality level is a result of both PM densities and the odor level. It may differ from the PM10, PM2.5 and PM1.0 density levels.
- Even two products placed in the same space could measure the PM10 density differently due to air circulation.
- The chemicals contained in air fresheners, perfumes, deodorizers or cosmetics may affect the overall air quality display.
- The dust density displayed may change with environmental factors such as the presence of sofas, beds, carpets, vacuum cleaners, humidity, smoke, bugs, pets or cooking oils.
- The PM densities may be affected by changes in the outside environment such as construction, heavy traffic or pollen.
- The micro dust density could be higher near outside doors, windows, vents or in areas where outside air enters.
- Use ONLY water to clean the sensor. Using anything else could cause product failure.
- The fine dust density could be affected by cooking or using humidifiers, sprays or other products which generate steam or fine particles.

## Using the Air Ionizer

To generate ions to remove various bacteria from the air.

Press the **Booster Speed** button for more than 3 seconds while operating.

-  (Ionizer) is displayed on the status display.

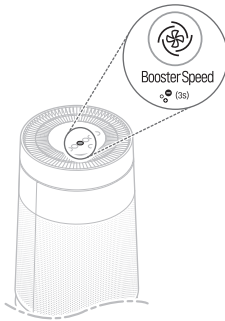

### Note

- When the operation is stopped, the ionizer function can not be used.
- The ionizer function is available in all operating modes.

## Setting the Sleep Timer

You can set the product to stop automatically after running for the duration you set.

Press the **Sleep Timer** button during the operation.

- Each time you press the button, the Sleep Timer changes in the following order: After 2 hours → After 4 hours → After 8 hours → After 12 hours → Cancel.
- Once the sleep timer is set, the status panel displays only the  sleep timer icon except for a few other icons.

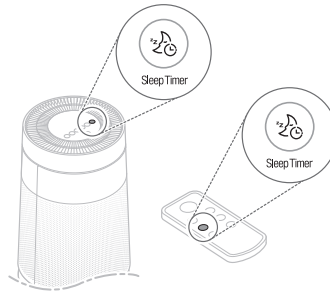

### Note

- For your deep sleep, the speed is set to Low by default for a certain period of time. After the time passes, the speed is controlled automatically depending on the air quality.
- Even when the sleep timer is set, you can still change the speed by pressing the **Speed** button.
- If you press the **Sleep Timer** button once more while the sleep timer is set, you can check the preset time and press the button repeatedly to cancel the sleep timer.
- The sleep timer remains on even if the power goes off or if there is a blackout.

# Locking the Control Panel Buttons

You can lock the buttons on the Control Panel to prevent the product from operating due to unforeseen reasons, such as a child manipulating the buttons.

Press the **Sleep Timer** button for at least 3 seconds during the operation.

-  (Lock) is displayed on the status panel.

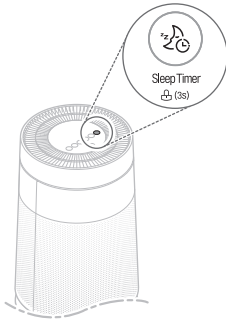

## Note

- You can turn off the lock function in the same way as turning it on.
- The control panel can be locked even when the product is off.
- If you pull out the power plug in lock set status, the lock function is cleared.

# Smart Functions

## LG ThinQ Application

The LG ThinQ application allows you to communicate with the appliance using a smartphone.

## LG ThinQ Application Features

### Smart Diagnosis

If you experience a problem while using the appliance, this smart diagnosis feature will help you diagnose the problem.

### Settings

Allows you to set various options on the appliance and in the application.

### NOTE

- If you change your wireless router, Internet service provider, or password, delete the registered appliance from the LG ThinQ application and register it again.
- The application is subject to change for appliance improvement purposes without notice to users.
- Functions may vary by model.

## Before using LG ThinQ Application

This feature is only available on models with Wi-Fi function.

- 1** Check the distance between the appliance and the wireless router (Wi-Fi network).
  - If the distance between the appliance and the wireless router is too far, the signal strength becomes weak. It may take a long time to register or installation may fail.

- 2** Turn off the Mobile data or Cellular Data on your smartphone.

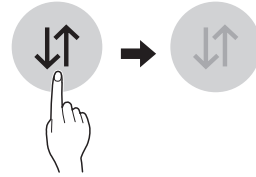

- 3** Connect your smartphone to the wireless router.

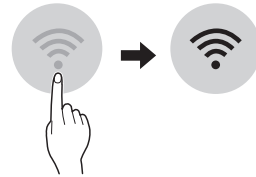

### NOTE

- To verify the Wi-Fi connection, check that Wi-Fi  icon on the control panel is lit.
- The appliance supports 2.4 GHz Wi-Fi networks only. To check your network frequency, contact your Internet service provider or refer to your wireless router manual.
- LG ThinQ is not responsible for any network connection problems or any faults, malfunctions, or errors caused by network connection.
- If the appliance is having trouble connecting to the Wi-Fi network, it may be too far from the router. Purchase a Wi-Fi repeater (range extender) to improve the Wi-Fi signal strength.
- The Wi-Fi connection may not connect or may be interrupted because of the home network environment.
- The network connection may not work properly depending on the Internet service provider.
- The surrounding wireless environment can make the wireless network service run slowly.

- The appliance cannot be registered due to problems with the wireless signal transmission. Unplug the appliance and wait about a minute before trying again.
- If the firewall on your wireless router is enabled, disable the firewall or add an exception to it.
- The wireless network name (SSID) should be a combination of English letters and numbers. (Do not use special characters.)
- Smartphone user interface (UI) may vary depending on the mobile operating system (OS) and the manufacturer.
- If the security protocol of the router is set to WEP, you may fail to set up the network. Please change it to other security protocols (WPA2 is recommended) and register the product again.

## Installing the LG ThinQ Application

Search for the LG ThinQ application from the Google Play Store or Apple App Store on a smartphone. Follow instructions to download and install the application.

## Wireless LAN Module Specifications

Model	LCW-003
Frequency Range	2412 - 2472 MHz
Output Power (max)	IEEE 802.11b: 18.37 dBm IEEE 802.11g: 17.67 dBm IEEE 802.11n: 17.67 dBm

Wireless function S/W version : V 1.0

For consideration of the user, this device should be installed and operated with a minimum distance of 20 cm between the device and the body.

## Open Source Software Notice Information

To obtain the source code under GPL, LGPL, MPL, and other open source licenses, that is contained in this product, please visit <http://opensource.lge.com>.

In addition to the source code, all referred license terms, warranty disclaimers and copyright notices are available for download.

LG Electronics will also provide open source code to you on CD-ROM for a charge covering the cost of performing such distribution (such as the cost of media, shipping, and handling) upon email request to [opensource@lge.com](mailto:opensource@lge.com). This offer is valid for a period of three years after our last shipment of this product. This offer is valid to anyone in receipt of this information.

## Smart Diagnosis

This feature is only available on models with the  logo.

Use this feature to help you diagnose and solve problems with your appliance.

### NOTE

- For reasons not attributable to LGE's negligence, the service may not operate due to external factors such as, but not limited to, Wi-Fi unavailability, Wi-Fi disconnection, local app store policy, or app unavailability.
- The feature may be subject to change without prior notice and may have a different form depending on where you are located.

## Using LG ThinQ to Diagnose Issues

If you experience a problem with your Wi-Fi equipped appliance, it can transmit troubleshooting data to a smartphone using the **LG ThinQ** application.

- Launch the **LG ThinQ** application and select the **Smart Diagnosis** feature in the menu. Follow the instructions provided in the **LG ThinQ** application.

## Using Audible Diagnosis to Diagnose Issues

Follow the instructions below to use the audible diagnosis method.

- Launch the **LG ThinQ** application and select the Smart Diagnosis feature in the menu. Follow the instructions for audible diagnosis provided in the **LG ThinQ** application.

- 1 Press and hold the **Indicator** button for 5 seconds or more to execute the Smart Diagnosis function.

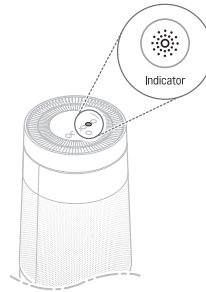

- 2 Hold the phone on the  logo on the back of the appliance.

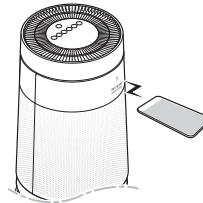

- 3 After the data transfer is complete, the diagnosis will be displayed in the application.

### NOTE

- For best results, do not move the phone while the tones are being transmitted.



# Maintenance

## ! Caution

- You must stop operating the product and unplug it before you clean and replace the filter.
- Do not spray water directly on the product.
- Assemble the product in the reverse order of disassembly after cleaning the product and replacing the filter.
- How to distinguish between the front and back of the product: There is an LG logo on the front, while 'PM 1.0 & GAS SENSOR SYSTEM' is written on the back.

- Filters are sold at the nearest Service Center or via the Consumables shop on the LG Electronics site ([www.lg.com](http://www.lg.com)).
- You may also request cleaning or replacement of the filter to the Service Center. You will be charged a certain fee for filter cleaning and replacement services.
- If there are no changes to the dust concentration on the status panel, clean the sensor regardless of the cleaning frequency (2 months) of the PM 1.0 sensor. For more information on cleaning the PM1.0 sensor, please see **Cleaning the Dust Sensor**.

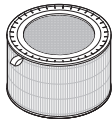
## Scheduled Maintenance



Component	Cleaning Frequency	Replacement Frequency
 Filter	<b>Only ultra-fine filter</b>  If contaminated, clean the ultra-fine filter with a vacuum cleaner or soft brush.	<b>The whole filter</b>  1 year
 PM 1.0 (super ultra-fine dust) sensor	2 months	-

### Note

- The operating environment and operation hours may affect the cleaning frequency. We recommend that you should clean it more often in a dusty environment.
- If you do not clean the product according to the cleaning frequency, you may experience a bad odor and poor performance.

## Alerts on the Status Panel

When you see an alert message on the status panel, do the following:

Alert	Measures
	<ul style="list-style-type: none"> <li>• Replace the upper filter.</li> </ul>
	<ul style="list-style-type: none"> <li>• Replace the lower filter.</li> </ul>

### Note

- Filter replacement alerts appear based on the maximum usage time, taking into account the operating hours of the product. The replacement frequency is determined by the operating hours and environment.
- For more information on how to disable a filter replacement alert, see **Replacing the Filter**.
- A filter is a consumable item. Therefore you must buy a new one for replacement when it has reached the end of its lifespan even during the warranty period.

**! Caution**

- Do not disassemble the clean booster arbitrarily.
- If the clean booster cover comes apart, secure it by aligning the 3 hooks with the slots before you use the product.

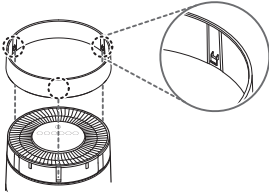

- Do not unscrew the 2 screws fixing the clean booster grille on the back while the product is running.

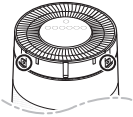

## Cleaning the Exterior

- 1** Remove dust from the air inlet and outlet using a vacuum cleaner.

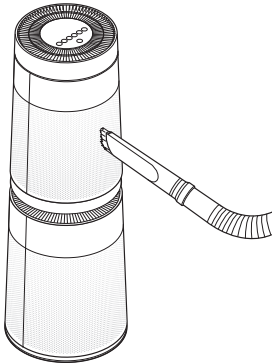

- 2** Wipe the exterior with soft cloth.

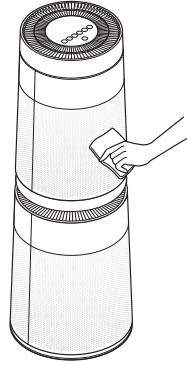

**! Caution**

- Do not clean the product with an alkaline detergent.
- Do not wipe the product surface using sulfuric acid, hydrochloric acid or organic solvent (thinner, kerosene etc.) or attach a sticker on the product. Otherwise the product surface may get damaged.
- Do not allow the water enter inside the product.

**Note**

If you find it difficult to clean the front and rear covers, separate them first and wash with water. Then, dry them completely under the shade.

## Cleaning the Filter

- 1 Separate the cover from the product.
  - For more information on how to remove and mount the cover, please see **Removing Packing Materials**.
- 2 Remove dust from the ultra-fine filter with a vacuum cleaner or soft brush.

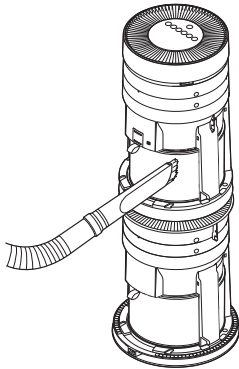

### **Caution**

- Do not wash the filter with water. It may reduce the lifespan of the filter.
- Be careful not to damage the ultra fine filter when you use a vacuum cleaner.

## Replacing the Filter

- 1 Remove the cover and replace the filter.
  - For more information on how to remove the cover and replace the filter, please see **Removing Packing Materials**.
  - To avoid polluting the surroundings when replacing the filter, place a newspaper on the floor before you remove the filter.
- 2 Once you have replaced the filter, disable the filter replacement alert.

## Disabling an Upper Filter Replacement Alert

Press and hold the **Speed** and **Indicator** buttons simultaneously for 3 seconds or more.

- The  (Upper Filter Replacement Alert) is disabled and the replacement alarm is reset.

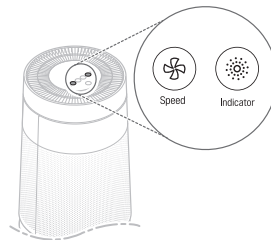

## Disabling a Lower Filter Replacement Alert

Press and hold the **Indicator** and **Sleep Timer** buttons simultaneously for 3 seconds or more.

- The  (Lower Filter Replacement Alert) is disabled and the replacement alarm is reset.

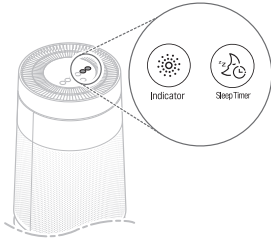

### Note

- The filter replacement alert is disabled automatically if 24 hours have passed since it was displayed or if the product is disconnected from the power source.

## Cleaning the Dust Sensor

PM 1.0 (super ultra-fine dust) sensor detects the fine dust as well as coarse dust. Therefore, you need to clean its lens regularly.

- 1** Remove the rear cover from the product.
  - For more information on how to remove and mount the cover, please see **Removing Packing Materials**.
- 2** Open the sensor cover.

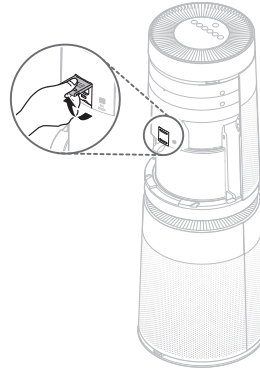

- 3** Clean the lens with the cotton swab soaked with water and clean it again with a dry cotton swab.

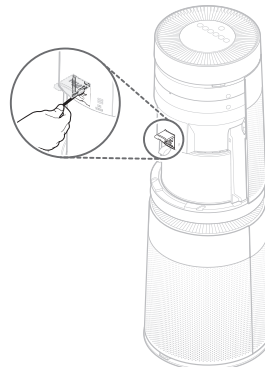

- 4** Close the sensor cover.

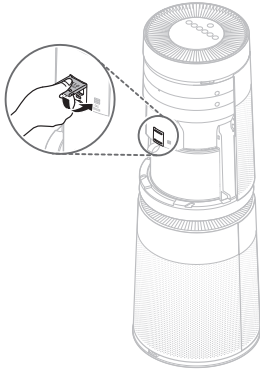

**Note**

Do not wipe the sensor with material other than water. It may cause a product failure.

**Storage**

If the product is not used for a long period of time, store it at a shaded and dry place.

- 1** Operate the product in **Dual** mode for one hour or more on a fine day.
- This removes the moisture and prevents molds from building up inside the product.

- 2** Turn off the power and unplug it from the electrical outlet.
- Wind the power cord around the bottom of the product.

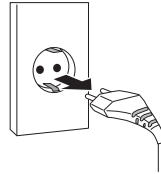

**Note**

The shape of the power plug differs depending on the country.

- 3** Package the product to prevent the dust or foreign substance from entering the product. Store the packaged product at a shaded place.

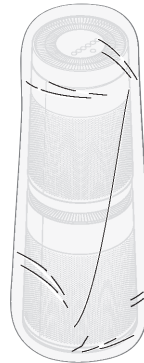

**⚠ Caution**

Do not store the product at a humid place or at a place exposed to the direct sunlight. Otherwise the product may be deformed, malfunction or generate odor.

# Before Calling for Service

If a failure occurs in the product, check the following before contacting the Service Center.

Symptom	Cause	Solution
The product does not operate.	Is the power plug unplugged from the outlet?	<ul style="list-style-type: none"> <li>• Plug it into the outlet properly.</li> </ul>
Fan is noisy even on the lowest speed.	Did dust accumulate in the ultra fine filter?	<ul style="list-style-type: none"> <li>• Clean the ultra fine filter properly.</li> </ul>
	Did dust accumulate in the Total Allergen Collection Care Filter?	<ul style="list-style-type: none"> <li>• Replace the whole filter.</li> </ul>
The indoor air is not purified well enough.	Is the indoor contamination severe?	<ul style="list-style-type: none"> <li>• Ventilate the indoor air before you use the product.</li> </ul>
	Did dust accumulate in the ultra fine filter?	<ul style="list-style-type: none"> <li>• Clean the ultra fine filter properly.</li> </ul>
	Did dust accumulate in the Total Allergen Collection Care Filter?	<ul style="list-style-type: none"> <li>• Replace the filter.</li> </ul>
	Are you using it in a place that is too spacious or too open?	<ul style="list-style-type: none"> <li>• Use a product that fits the size of the room.</li> <li>• Avoid a well-ventilated place such as a gate, window, etc.</li> </ul>
	Is there any obstacle nearby?	<ul style="list-style-type: none"> <li>• Remove the obstacle.</li> </ul>
	Is the product installed at a corner?	<ul style="list-style-type: none"> <li>• Move the product and install it again.</li> </ul>
There is a smell, but the Light lamp does not change.	Is the Light lamp turned on red or orange?	<ul style="list-style-type: none"> <li>• The color of overall air quality is determined based on whichever is worse between the dust concentration and smell (gas) concentration. Check if the dust concentration is worse than before.</li> <li>• The smell (gas) sensor detects the gas that causes contamination, so it may not react to the food smell Indian food such as curry and breads etc. But the Total Harmful Gas Care Filter does remove the odor.</li> </ul>

Symptom	Cause	Solution
The Light lamp continues to stay red.	Doesn't the color change even if it is moved to a clean room?	<ul style="list-style-type: none"> <li>• If the amount of the smell is more than the capacity of the product, the display may not change.</li> <li>• Clean the sensor area.</li> <li>• Remove the power plug from the outlet and reconnect it one minute later.</li> </ul>
	Did you use a spray near the product?	<ul style="list-style-type: none"> <li>• Do not use a spray near the product.</li> </ul>
The buttons on the control panel do not work.	Is the  (Lock) turned on on the status panel?	<ul style="list-style-type: none"> <li>• Press and hold the <b>Sleep Timer</b> button for 3 sec. or longer to disable the lock function.</li> </ul>
The concentration of the fine dust does not change.	Is there a foreign substance on the sensor?	<ul style="list-style-type: none"> <li>• Clean the PM 1.0 (super ultra-fine dust) sensor.</li> </ul>
	Is the product used in a closed space?	<ul style="list-style-type: none"> <li>• In a closed space, the cleanliness level may continue to stay the same without change.</li> </ul>
The concentration of fine dust continues to remain high.	Does the air continue to flow in from the outside to the location where the product is installed?	<ul style="list-style-type: none"> <li>• In an environment where outside air is supplied continuously, the concentration may continue to remain high.</li> </ul>
The overall air quality color does not match the dust concentration value.	Does the color of the overall air quality match the color that indicates the smell concentration?	<ul style="list-style-type: none"> <li>• The overall air quality is displayed by evaluating the smell and dust concentration comprehensively.</li> <li>• Even if the dust concentration is low, if the odor is strong, the overall air quality color may not match the dust concentration value.</li> </ul>

Symptom	Cause	Solution
The overall air quality is different from that of the Ministry of Environment guide.	Is the guide from the Ministry of Environment different from the product dust concentration?	<ul style="list-style-type: none"> <li>The Ministry of Environment guide shows the average value over a certain period of time, but the overall air quality displayed on the product is measured in real time. So they may be different from each other.</li> </ul>
A strange smell comes out from the air outlet as well as the filter.	Did you purchase the product lately?	<ul style="list-style-type: none"> <li>The odor of activated charcoal is not harmful. This is similar to the smell you may experience in a brand new car. We assure it will go away 1-2 weeks after its first use.</li> </ul>
	Is the product used at a place with a lot of smoke or smell?	<ul style="list-style-type: none"> <li>In a place with a lot of smoke or smell, the air cleaning function may deteriorate. Ventilate the room first and then use the product.</li> </ul>
	Does the filter have a bad smell?	<ul style="list-style-type: none"> <li>Replace the filter. The filter replacement frequency may differ depending on the usage environment.</li> </ul>
	Is the product installed in an environment where a lot of odor occurs?	<ul style="list-style-type: none"> <li>If you use the product for a long period of time while you cook or broil fish/meat, the filter lifespan may be rapidly decreased.</li> <li>If possible, open the window for ventilation while cooking, and use the product to remove the smell left after the ventilation.</li> </ul>
The clean booster is not working.	Is the operation mode set to the Clean Booster mode?	<ul style="list-style-type: none"> <li>The booster fan speed and booster fan rotation functions work only in the Clean Booster mode.</li> </ul>
A noise is generated when I start or stop the clean booster.	-	<ul style="list-style-type: none"> <li>It means that the clean booster is trying to look for the correct location.</li> </ul>

Symptom	Cause	Solution
I can't connect to the product in the LG ThinQ app.	Is the power plug unplugged from the outlet?	<ul style="list-style-type: none"> <li>• Plug in the power cord of the product.</li> </ul>
	Is the wireless router connected with the product not working?	<ul style="list-style-type: none"> <li>• Power off the wireless router and on again.</li> <li>• Check if there is an Internet connection problem with the router.</li> </ul>
I can't register the product in the LG ThinQ app.	Is the product too far away from the wireless router?	<ul style="list-style-type: none"> <li>• Move the wireless router near the product.</li> </ul>
	Is your wireless router working properly?	<ul style="list-style-type: none"> <li>• Some carriers provide routers that are available to their members only. If you have an outdated model, contact your carrier to have it replaced with a newer one.</li> </ul>
The dust concentration levels are different between the product and the LG ThinQ app.	Are you looking at the same dust particle?	<ul style="list-style-type: none"> <li>• Make sure that the levels of the super ultra-fine/ultra-fine/fine dust are displayed consistently between the LG ThinQ app and your product.</li> <li>• The difference in the values could be caused by the difference in update time between the LG ThinQ app and the product.</li> </ul>

# Product Specifications

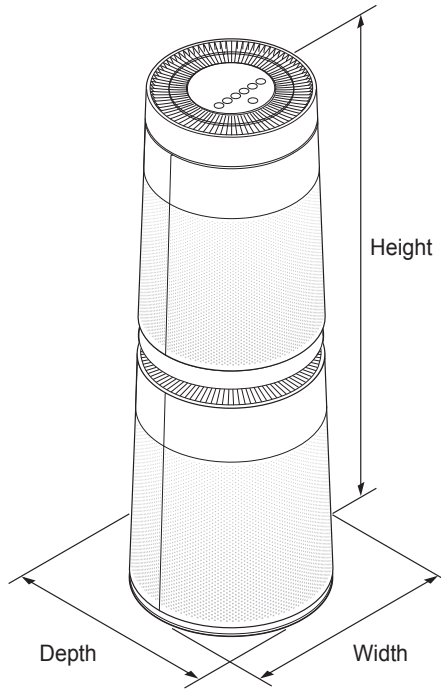

The external appearance and dimensions of the product are subject to change without prior notice.

<b>Model</b>	AS95GD Series
<b>Power</b>	AC 220–240 V 50 / 60 Hz
<b>Exterior dimensions (Width X Height X Depth)</b>	When the clean booster is not running: 373 mm x 1,073 mm x 373 mm
	When the clean booster is running: 373 mm x 1,310 mm x 373 mm