





ENGLISH

FRANÇAIS

ESPAÑOL

OWNER'S MANUAL REFRIGERATOR FREEZER

Please read this manual carefully before operating your set and retain it for future reference.



MFL62883346

www.lg.com

Table of contents

Introduction	Entry	4
	Important safety instruction	4
	Identification of parts	13
Installation	Where to install	15
Operation	Starting	16
	Adjusting the temperatures and functions	16
	Ice making	20
	Refrigerator compartment	21
	Door in Door Use Skills (Only apply for some Models)	22
	Use Skills for Multi-use Compartment	23
	Use Skills for Freezer Compartment (lower)	23
Suggestion on food storage	Location of foods	24
	Storing foods	26
Care and maintenance	How to dismantle parts	27
	Cleaning	30
	General information	31
	Trouble shooting	32
Smart Diagnosis	Smart Diagnosis (Only apply for some Models)	36

Entry

The model and serial numbers are found on the inner case or back of refrigerator compartment of this unit. These numbers are unique to this unit and not available to others. You should record requested information here and retain this guide as a permanent record of your purchase. Staple your receipt here.

Date of purchase : _____

Dealer purchased from : _____

Dealer address : _____

Dealer phone no. : _____

Model no. : _____

Serial no. : _____

Important safety instruction

Before it is used, this refrigerator must be properly installed and located in accordance with the installation instructions in this document.

When moving your appliance away from the wall, be careful not to roll over the power cord or to damage it in any way.

After your refrigerator is in operation, do not touch the cold surfaces in the freezer compartment, particularly when your hands are damp or wet. Skin could adhere to these extremely cold surfaces.

Unplug the power cord from the power outlet for cleaning or other requirements. Never touch it with wet hands because you can get an electric shock or be hurt.

Never place glass products in the freezer because they may be broken due to expansion when their contents are frozen.

Never allow your hands within the ice storage bin of the automatic ice maker. You could be hurt by the operation of the automatic ice maker.

The appliance is not intended for use by young children or infirm persons without supervision.

Don't use an extension cord

If possible, connect the refrigerator to its own individual electrical outlet to prevent it and other appliances or household lights from causing an overload that could cause a power outage.

Accessibility of Supply Plug

The refrigerator-freezer should be so positioned that the supply plug is accessible for quick disconnection when accident happens.

Supply Cord Replacement

If the supply cord is damaged, it must be replaced by the manufacturer or its service agent or a similarly qualified person in order to avoid a hazard.

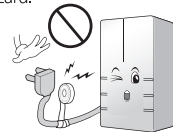

! Important safety instruction

BASIC SAFETY PRECAUTIONS

This guide contains many important safety messages. Always read and obey all safety messages.

! This is the safety alert symbol. It alerts you to safety messages that inform you of hazards that can kill or hurt you or others or cause damage to the product. All safety messages will be preceded by the safety alert symbol and the hazard signal word DANGER, WARNING, or CAUTION. These words mean:

! **DANGER** You will be killed or seriously injured if you don't follow instructions.

! **WARNING** You can be killed or seriously injured if you don't follow instructions.

! **CAUTION** Indicates an imminently hazardous situation which, if not avoided, may result in minor or moderate injury, or product damage only.

All safety messages will identify the hazard, tell you how to reduce the chance of injury, and tell you what can happen if the instructions are not followed.

! WARNING

To reduce the risk of fire, electric shock, or injury to persons when using your product, basic safety precautions should be followed, including the following. Read all instructions before using this appliance.

1. When connecting the power

The dedicated outlet should be used.

- Using several devices at one outlet may cause fire.
- The electric leakage breaker may damage food and the dispenser may be leaked.



Do not allow the power plug to face upward or to be squeezed at the back of the refrigerator.

Water may be flown into or the plug may be damaged, which causes fire or electric shock.

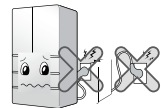

Prevent the power cord from being squeezed or imprinted if the refrigerator is pushed in after the power plug is extracted during the installation.

It becomes the cause of fire or electric shock. When moving your appliance away from the wall, be careful not to roll over or damage the power cord.

Important safety instruction

Do not allow the power cord bent or pressed by the heavy object to be damaged.

It may damage the power cord to cause fire or electric shock.



Do not extend or modify the length of the power plug.

It causes electric shock or fire by the electric damage of the power cord or others.



Unplug the power plug when cleaning, handling or replacing the interior lamp of the refrigerator.

- It may cause electric shock or injury.
- When replacing the interior lamp of the refrigerator, make sure that the rubber ring for preventing the electric spark within the socket is not taken off.

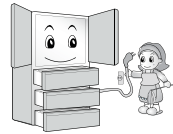

Do not pull out the cord or touch the power plug with wet hands.

- It may cause electric shock or injury.

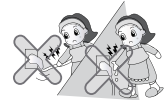

Remove water or dust from the power plug and insert it with the ends of the pins securely connected.

Dust, water or unstable connection may fire or electric shock.

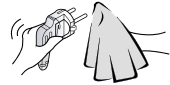

Pull out the power plug not by grasping the cord but the plug of its end.

It may cause electric shock or short circuit to fire.



Make sure of grounding.

Consult a qualified electrician or service person if the grounding instructions are not completely understood, or if you have doubts on whether the appliance is properly grounded or not.

The incorrect grounding may cause breakdown and electric shock.

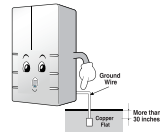

Be sure to use grounded exclusive proper voltage consent for the power plug.

It becomes the cause of fire.

Important safety instruction

When the power cord or the power plug is damaged or the holes of the outlet are loosed, do not use them.
It may cause electric shock or short circuit to make fire.

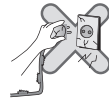

Wait for 5 minutes or longer when reconnecting the plug.

It may cause the operation of the freezer to fail.



If the supply cord is damaged, it must be replaced by the manufacturer or its service agent or a similarly qualified person in order to avoid any hazard.

2. When using the refrigerator

Do not place the heavy object or the dangerous object (container with liquid) on the refrigerator.

It may be dropped to cause injury, fire or electric shock when opening or closing the door.



Do not install the refrigerator in the wet place or the place which water or rain splashes.

Deterioration of insulation of electric parts may cause electric leakage.

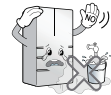

Do not cling to the door or the shelves of the door or the home bar of the freezer or the cool chamber.

It may make the refrigerator fallen down or damage the hands. Especially, do not allow the children to do the above.



Prevent children from entering the product.

It may endanger the life of a child if the child enters the refrigerator.



Opening and closing the door of the refrigerator vigorously may cause the stored food in the refrigerator basket to fall by shock and hurt the foot, so take precautions.

Important safety instruction

Do not use or store inflammable materials ether, benzene, alcohol, medicine, LP gas, spray or cosmetics near or in the refrigerator.

It may cause explosion or fire.

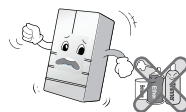

Do not place the lit candle within the fridge-freezer to deodorize. Do not use drier to dry the inside, nor light a candle to remove odor.

It may cause explosion or fire.



Do not store the medicine or the academic materials at the refrigerator.

When the material with the strict temperature control is stored, it may be deteriorated or it may make an unexpected reaction to cause any risk.



Do not use the combustible spray near the refrigerator.

It may cause fire.

Do not store explosive substances such as aerosol cans with a flammable propellant in this appliance.



Avoid the heating devices. Install in places away from the fire such as the place where flammable gas is leaked.

It may cause fire.



Do not place flower vase, cup, cosmetics, medicine or any container with water on the refrigerator.

It may cause fire, electric shock or injury by dropping down.



! Important safety instruction

Use the submerged refrigerator after checking it.

It may cause electric shock or fire.

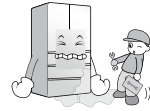

In case of thunder and lightning, or not in use for a long period of time, detach the power plug.

There is a danger of electric shock or fire.

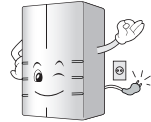

When gas is leaked, do not touch the refrigerator or the outlet and ventilate the room immediately.

- The explosion by spark may cause fire or burn.
- Because this refrigerator uses natural gas (isobutene, R600a) as the environment-friendly refrigerant, even a small amount (80~90g) is combustible. When the gas is leaked by the severe damage during delivering, installing or using the refrigerator, any spark may cause fire or burn.

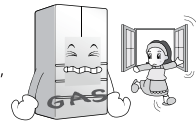

Do not spray water at the outside or the inside of the refrigerator or do not clean it with benzene or thinner.

Deterioration of insulation of electric parts may cause electric shock or fire.



When any strange smell or smoke is detected from the refrigerator, disconnect the power plug immediately and contact to the service center.

It may cause fire.

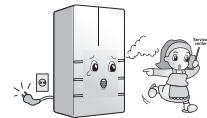

Do not allow any person except the qualified engineer to disassemble, repair or alter the refrigerator.

It may cause injury, electric shock or fire.

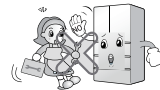

Important safety instruction

Do not use the refrigerator for non-domestic purpose (storing medicine or testing material, using at the ship, etc.).

It may cause an unexpected risk such as fire, electric shock, deterioration of stored material or chemical reaction.

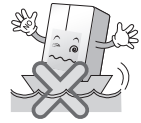

When disposing the refrigerator, remove the packing material from the door or take off the doors but leave the shelves in place so that children may not easily climb inside.

It may cause to lock out the child.



This appliance is not intended for use by persons (including children) with reduced physical, sensory or mental capabilities, or lack of experience and knowledge, unless they have been given supervision or instruction concerning use of the appliance by a person responsible for their safety.

Children should be supervised to ensure that they do not play with the appliance.

Install the refrigerator on the solid and level floor.

Installing it on the unstable place may cause death by falling down the refrigerator when opening or closing the door.



Do not insert the hands or the metal stick into the exit of cool air, the cover, the bottom of the refrigerator, the heatproof grill (exhaust hole) at the backside.

It may cause electric shock or injury.



When you want to dispose the refrigerator, contact to the down-block office.

When you want to dispose the large living waste such as electric home appliance and furniture, you'd better contact the local down block office.



Supply the automatic ice maker only with drinkable water. (Only for the model with the automatic ice maker) .

• Otherwise, it may cause a risk.



Important safety instruction

CAUTION

Violating this direction may cause injury or damage house or furniture.
Always be careful, please.

Do not touch food or containers at the freezer with wet hands.

It may cause frostbite.

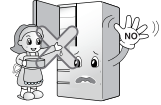

When the electricity is off for long time, remove ice from the ice box.

- Ice may melt due to long-time power failure.



Do not place the food in disorder inside the refrigerator.

The food may fall during opening and closing the door of the refrigerator and hurt people.

Do not put bottle in the freezer.

It may freeze the contents to break the bottle to cause injury.



Do not insert the hands into the bottom of the refrigerator.

The iron plate of the bottom may cause injury.



Carry the refrigerator with the handle bar at the bottom of the front and the top of the rear.

Otherwise, your hands may be slipped to cause injury.
Because the product is heavy, carrying it alone may hurt people or accidents may occur.

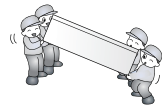

Because opening or closing the door of the refrigerator may cause injury to the person around it, be careful, please.

Opening or closing the door may cause feet or hands to be caught in the chink in door or the child to be get hurt by the corner.







Do not put any living animal in the refrigerator.



Important safety instruction

WARNING

-  Keep ventilation openings, in the appliance enclosure or in the built-in structure, clear of obstruction.
-  Do not use mechanical devices or other means to accelerate the defrosting process, other than those recommended by the manufacturer.
-  Do not damage the refrigerant circuit.
-  Do not use electrical appliances inside the food storage compartments of the appliance, unless they are of the type recommended by the manufacturer.
-  The refrigerant and insulation blowing gas used in the appliance require special disposal procedures. When disposal, please consult with service agent or a similarly qualified person.



This appliance contains a small amount of isobutane refrigerant (R600a), natural gas with high environmental compatibility, but it is also combustible. When transporting and installing the appliance, care should be taken to ensure that no parts of the refrigerating circuit are damaged. Refrigerant squirting out of the pipes could ignite or cause an eye injury. If a leak is detected, avoid any naked flames or potential sources of ignition and air the room in which the appliance is standing for several minutes.

In order to avoid the creation of a flammable gas air mixture if a leak in the refrigerating circuit occurs, the size of the room in which the appliance may be sited depends on the amount of refrigerant used. The room must be 1m² in size for every 8g of R600a refrigerant inside the appliance. The amount of refrigerant in your particular appliance is shown on the identification plate inside the appliance. Never start up an appliance showing any signs of damage. If in doubt, consult your dealer.

Child entrapment warning

⚠ DANGER: Risk of child entrapment.

Before you throw away your old refrigerator or freezer:

Take off the doors but leave the shelves in place so that children may not easily climb inside.

The appliance is not intended for use by young children or infirm persons without supervision.

Young children should be supervised to ensure that they do not play with the appliance.

Don't store

Don't store or use gasoline or other flammable vapor and liquids in the vicinity of this or any other appliance.

Grounding (Earthing)

In the event of an electric short circuit, grounding (earthing) reduces the risk of electric shock by providing an escape wire for the electric current.

In order to prevent possible electric shock, this appliance must be grounded. Improper use of the grounding plug can result in an electric shock. Consult a qualified electrician or service person if the grounding instructions are not completely understood, or if you have doubts on whether the appliance is properly grounded.

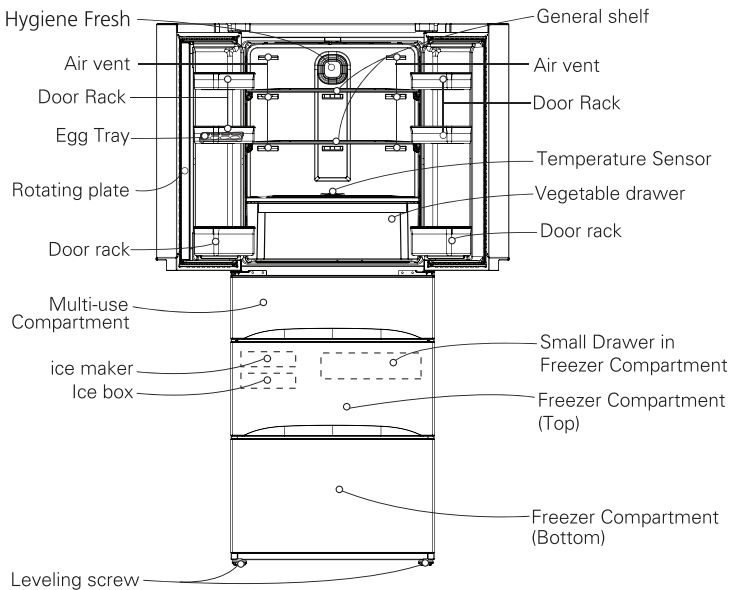
Identification of parts**Type-1**

Identification of parts

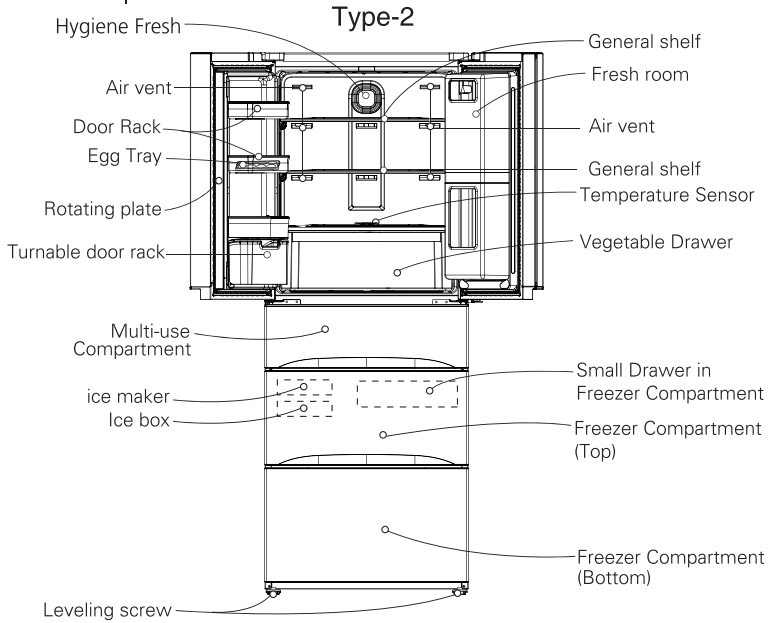

Note

Parts, features, and options vary by model. Your model may not include every option.

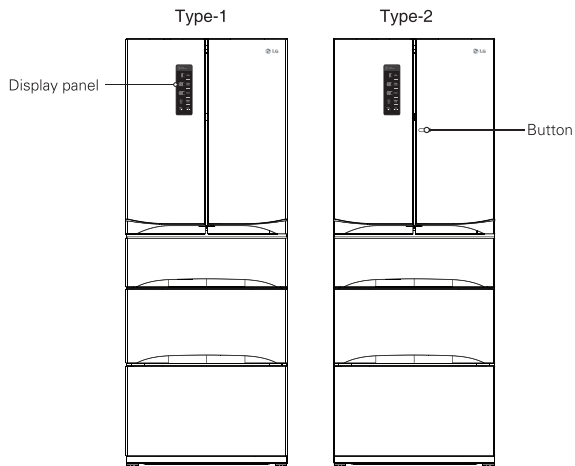

Where to install

Select a good location

1. Select a good location. Place your fridge-freezer where it is easy to use.
2. Avoid placing the unit near heat sources, direct sunlight or moisture.
3. To ensure proper air circulation around the fridge -freezer, please maintain sufficient space on both the sides as well as top and maintain at least 2 inches (5cm) from the rear wall.

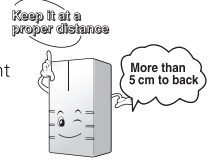

4. To avoid vibration, the unit must be leveled. If required, adjust the leveling screws to compensate for the uneven floor. The front should be slightly higher than the rear to aid in door closing. Leveling screws can be turned easily by tipping the cabinet slightly. Turn the leveling screws counterclockwise (⤿) to lower the unit, clockwise(⤵) to raise it.

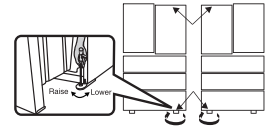

5. In case the doors incline downwards after the refrigerator is installed and foods are placed, adjust the parallelism of the doors as illustrated 4 – 5 days after the installation. Before adjusting the adjustable feet, open the bottom freezer compartment drawer.
6. Clean your fridge-freezer thoroughly and wipe off all dust accumulated during shipping.
7. Install accessories such as ice box, etc., in their proper places. They are packed together to prevent possible damage during shipment.

This appliance is intended to be used in household and similar applications such as staff kitchen areas in shops, offices and other working environments; farm houses and by clients in hotels, motels and other residential type environments; bed and breakfast type environments; catering and similar non-retail applications.

Disposal of the old appliance

This appliance contains fluid (refrigerant, lubricant) and is made of parts and materials which are reusable and/or recyclable. All the important materials should be sent to the collection center of waste material and can be reused after rework (recycling). For take back, please contact with the local agency.

Starting

When your refrigerator is first installed, allow it to stabilize at normal operating temperatures for 2-3 hours prior to filling it with fresh or frozen foods. If operation is interrupted, wait 5 minutes before restarting.

Adjusting the temperatures and functions

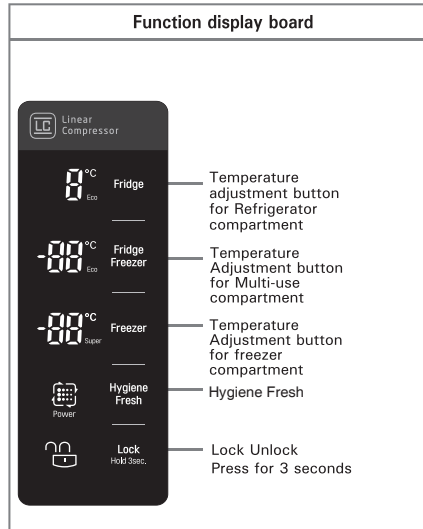
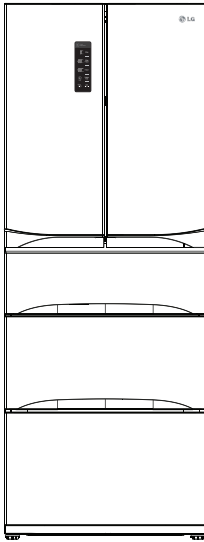

Adjusting the temperatures and functions

When doors are closed or stopping button selection for 20 seconds, the brightness of LED display will turn down. The power saving mode is activated. When a door is open or a button is pressed, the brightness of LED display will turn up.

You can adjust temperature of the freezer compartment, refrigerator compartment and multi-use compartment.

How to adjust the temperature in the refrigerator compartment

Refrigerator compartment temperature adjustment

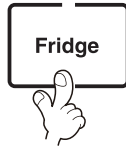

When you press "Fridge" button, the temperature of refrigerator compartment is repeated in the following order:

4°C → 3°C → 2°C → OFF → 8°C → 7°C → 6°C → 5°C → 4°C

How to adjust the temperature in the multi-use compartment

Multi-use compartment temperature adjustment



When you press "Fridge Freezer" button, the temperature of multi-use compartment is repeated in the following order:

0°C → -1°C → -2°C → -3°C → -7°C → -12°C → -15°C → -17°C → OFF → 7°C → 6°C → 5°C → 4°C → 3°C → 2°C → 1°C → 0°C

How to adjust the temperature in the freezer compartment

Freezer compartment temperature adjustment



When you press "Freezer" button, the temperature of freezer compartment is repeated in the following order:

-19°C → -20°C → -21°C → -22°C → -23°C → -24°C → -26°C(SUPER) → -16°C → -17°C → -18°C → -19°C

Note

The actual inner temperature varies depending on the food status, as the indicated setting temperature is a target temperature, not actual temperature within refrigerator.

Refrigeration function is weak in the initial time. Please adjust temperature as above after using refrigerator for minimum 2~3 days.

Adjusting the temperatures and functions

Refrigerator "ECO"

In order to save electricity when no food needs to be stored in the refrigerator compartment, you can select the Refrigerator ECO function, that is, to turn off the refrigerator compartment.

To put the refrigerator in the stop state, press "" repeatedly until "ECO" lights up.



Multi-use "ECO"

In order to save electricity when no food needs to be stored in the multi-use compartment you can select the multi-use compartment ECO function, that is, to turn off the multi-use compartment.

To put the multi-use compartment in the stop state, press "" repeatedly until "ECO" lights up.

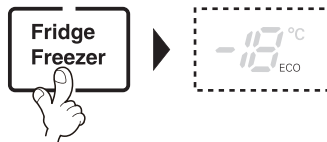

Super Freezer

Please select this function for prompt freezer.

Set super freezing: press "" key. The panel will display "-26 C" and "Super" indicating it is in the super freezing state.

Cancel super freezing: press "" key. The panel displays a temperature other than "-26 C" indicating it is not in the super freezing state any more. When the super freezing time is reached, it exits the super freezing state automatically and restores the set freezing temperature of "-21 C".

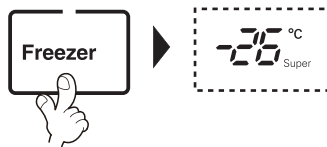

Adjusting the temperatures and functions

When you need to clean the air please select this function.

Hygiene Fresh
(Optional)

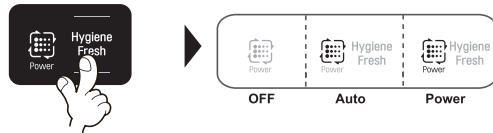

※ Potent air purification Setting:

Press “Hygiene Fresh” key. “” pattern and “Power” light will be on. It enters power mode.





Cancel: Press “Hygiene Fresh” key. “Power” light will be off. It exits power mode.

Note: In power mode, it exits power mode and returns to Automatic mode when time of power air purification elapses (Maximum 4 hours).

※ Press “Hygiene Fresh” key to adjust air purification.

Displayed content about air purification varies as follows:
OFF → Automatic Mode → Power mode → OFF

Lock

- Pressing this button stops operation of other buttons.
- Locking or Unlocking is repeated whenever pressing the “” button. (For “Locking” or “Unlocking” press the “” button for 3 secs.)
- When you use the “” button, you can not use any other button, Until you unlock the refrigerator. When you press the other buttons when the refrigerator is locked, the “” will flash 2 times to notify the current lock condition.

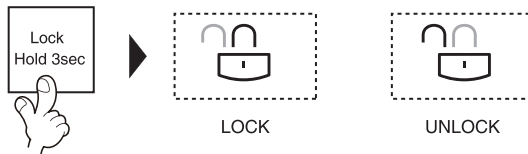

Door open alarm

- When the refrigerator compartment door, multi-use compartment drawer or freezer upper drawer is left open or not closed completely for more than 1 minute, it sounds 3 times every 30 seconds.
- If the warning sound remains after the refrigerator door, multi-use compartment drawer or freezer upper drawer is closed, contact your local service center.

**Self-diagnosis
(fault detection)
function**

Self-diagnosis function operates when a problem occurs in the unit. When an error occurs in the unit. Immediately contact the service center without turning the power OFF. If the power is OFF, it will take the engineer longer to find out where the fault occurs.

The pressing of any function buttons will not alter the temperature setting when a fault occurs.

Memory feature

When the power comes on again after a power failure, it is able to recall the last settings of refrigerator temperature, Refrigerator ECO, freezing temperature, multi-use compartment ECO and multi-use compartment temperature.

However, the Super Freezing can not be memorized. If the unit is in the Super Freezing state when the power is off, the freezing temperature will be set to “-21°C” after the power is recovered.

Ice making

1. Add water into ice cube tray.

If too much water is added, it cannot be easily separated into ice cubes. And water will drop into ice storage tray and already made ice cubes will freeze together.

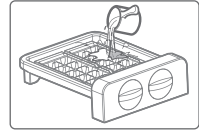

2. Rotate ice cube separation button of ice cube tray and ice cubes will drop into the ice storage tray.

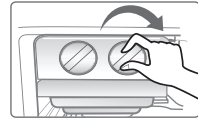

Please fill with potable water only.

Note

Rotating the Ice Dispenser knob before the icing procedure is complete would add the remaining water into the ice cube container. The ice cubes may stick together.

Refrigerator compartment

Sliding Shelf (Optional)

You can slide the sliding shelf in if you need to accommodate taller containers or products on the shelf underneath.

Note

Remove all items form the rear half shelf and the front sliding shelf.

1. Slightly lift up the front of the sliding shelf and slide it inward.
2. The rear half shelf will raise to allow the front to slide in under it, or it can be lifted manually toward the rear wall to allow easier sliding of the front sliding shelf.
3. You can simply pull out the sliding shelf in reverse procedure to return it to the extended position.

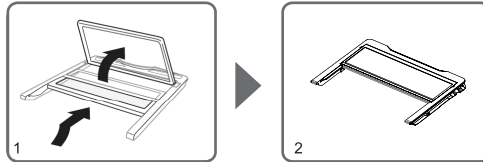

! CAUTION

Caution should be taken when adjusting the shelf as it can fall out if not handled correctly.

! CAUTION

Do not lift up the rear half shelf and keep it in the lifted position. Tall items are not to be stored at the rear of the shelf.

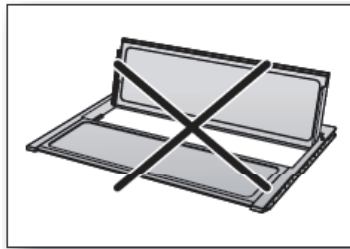

Refrigerator compartment

Rotatable partition

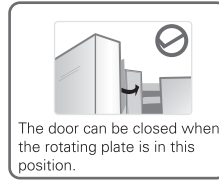
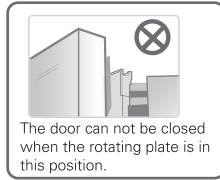

The door can not be closed when the rotating plate is in the raised position. It must be put back to its original position to close the door.

Note

To prevent dew drops form, choose rotating plates equipped with heater. It is normal for rotating plate to generate heat and this does not have effect on the foods.

Door in Door Use Skills (Only apply for some Models)

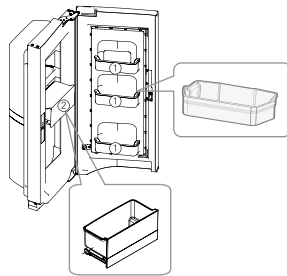

- 1. Use of Small Rack in Door within Door**
 Various bagged foods can be put in, such as ham, chocolate and other small volume packages for the convenience of reach.
- 2. Use of Small Drawer in Door within Door**
 Various bagged foods can be put in, such as ham, chocolate and other small volume packages for the convenience of reach.

Use Skills for Multi-use Compartment

When store vegetables and fruits, set the multi-use compartment temperature to 1-7°C; When store fish and meat for a short time, set the temperature to below 0°C. Therefore, always check the temperature setting before store food.

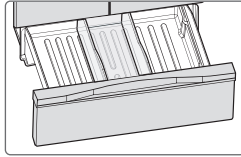

Use Skills for Freezer Compartment (lower)

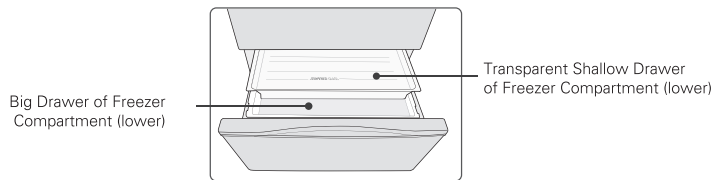

- Transparent shallow drawer is used to store pouch packed foods and big drawer is used to store large packed foods. Height of food stored should not exceed certain height. Otherwise, the transparent shallow drawer cannot be put in place. It can cause the drawer fails to be closed normally and foods cannot be frozen.

Location on foods

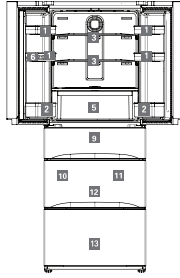

TYPE-1

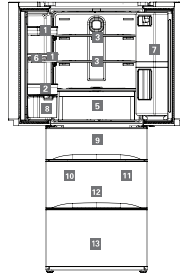

TYPE-2

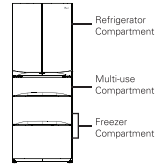

Suggestions on refrigerator storage

1 Door rack

Store small packages of milk or spices.



2 Bottle door rack

Store water and beverage.



3 General self

Store refrigerated food (The foods should be kept a certain distance between each other and the air outlet should never be blocked by the foods.)



4 Removable Shelf (optional)

For instructions on how to use, refer to the tips. (See page 21.) (The foods should be kept a certain distance between each other and the air outlet should never be blocked by the foods.)



5 Vegetable drawer

Store fruits and vegetables.



6 Egg tray (Optional)

Store eggs. (Take the egg tray out of the multi-use compartment when storing eggs. Store it in refrigerator compartment instead of the multi-use compartment.)

7 Fresh room (Optional)

Store common food, like drinks, wine and so on.



8 Turnable Rack (Optional)

Store milk or condiment of small packages. It can prevent dust from entering the rack.

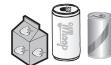

**Suggestions
on multi-use
compartment**

9 Drawer

Store refrigerated or frozen foods.

**Suggestions
on freezer
compartment**

10 Ice maker

For instructions on how to make ice, refer to the user guide.



11 Small drawer

Store frozen foods of small size.



12 Drawer (top)

Store frozen food for a long time.



13 Drawer (bottom)

Store frozen foods of large size.



※ If food is too bulky, remove shelf, vegetable drawer and drawers, etc.

Storing foods

- Store fresh food in the refrigerator compartment. How food is frozen and thawed is an important factor in maintaining its freshness and flavor.
- Do not store food which goes bad easily at low temperatures, such as bananas, and melons.
- Allow hot food to cool prior to storing, placing hot food in the refrigerator could spoil other food, and lead to higher energy consumption.
- When storing the food, cover it with vinyl wrap or store in a container with a lid. This prevents moisture from evaporating, and helps food to keep its taste and nutrients.
- Do not block air vents with food. Smooth circulation of chilled air keeps refrigerator temperatures even.
- Do not open the door frequently. Opening the door lets warm air enter the refrigerator, and cause temperatures to rise.
- Never keep too much food in door rack because they may push against by inner racks so that the door cannot be fully closed.
- Do not store bottles in the freezer compartment - they may break when frozen.
- Do not refreeze food that has been thawed. This causes loss of taste and nutrient.
- When storing frozen food like ice cream for a long period, place it on the freezer shelf, not in the door rack.
- Do not touch the cold foods or containers- especially made of metallic -, with wet hands and place glass products in the freezer compartment.

Freezer compartment

CAUTION

Refrigerator compartment

Note

- That's why you may have chilblains and they may be broken when their inner matters are frozen, causing personal injury.
- Avoid placing moist food in top refrigerator shelves, it could freeze from direct contact with chilled air.
- Always clean food prior to refrigeration. Vegetables and fruits should be washed and wiped, and packed food should be wiped, to prevent adjacent food from spoiling.
- When storing eggs in their storage rack or box, ensure that they are fresh, and always store them in an upright position, which keeps them fresh longer.
- If you keep the refrigerator in a hot and humid place, frequent opening of the door or storing a lot of vegetables in it may cause dew to form which has no effect on its performance. Remove the dew with dust cloth free from care.

Note

How to dismantle parts

Dismantling is done in the reverse sequence of assembly.
Be sure to unplug the power plug before dismantling and assembly.
Never apply severe force to dismantle parts. Parts may be damaged.

General shelf

- Lift the inside of the shelf and pull it out to remove the shelf;
- Install the shelf in the reverse order.

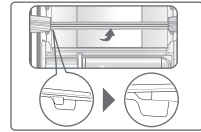
Removable Shelf
(only apply to some types)

- Slightly raise the front half of the removable shelf and slide inward. Raise the back half of the shelf and make the front half slide in below it. Or manually raise the back half towards the back wall to make the front half easily slide.
- Wash the removed shelf with water. Then wipe clean with dry soft cloth;
- The removable shelf can be easily pulled out and returned to its original position by taking contrary steps.

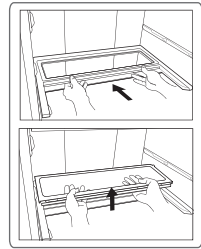
 **WARNING**

**Be cautious when adjusting the shelf.
If it is handled improperly, it may fall.**

Door rack

Tightly hold side of fresh room with one hand and gently tap upward with another hand from bottom. Lift up and take out the fresh room; Then take out the door rack and wash it with water. Wipe it dry with soft cloth; Install the rack in the reverse order.

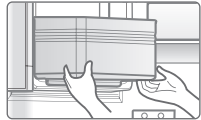
Removal and Cleaning
of Fresh room in Door
within Door
(only apply to some types)

1. First press switch button of door to open the fresh room.
2. Raise and take out small drawer above the fresh room.
3. Tightly hold side of fresh room with one hand and gently tap upward with another hand from bottom. Lift up and take out the fresh room.
4. Wash the drawer and the fresh room with water. Then dry it with soft cloth; Install the fresh room in the reverse order.

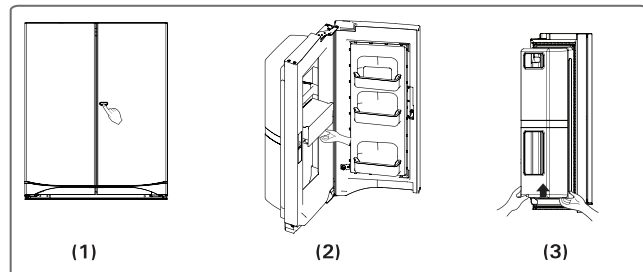

Vegetable drawer

Pull out the vegetable drawer till it cannot move. Raise outer side of the vegetable drawer and pull out the vegetable drawer;
Wash the vegetable drawer with water and dry it with soft cloth;
Install the vegetable drawer in the reverse order.

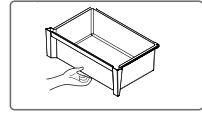

The drawer of multi-use compartment

1. For some models, small drawer should be taken out beforehand.
2. Pull the drawer all the way out, lift the outside of the whole set of the drawers and pull out slightly, then lift the white plastic drawer and take it out.

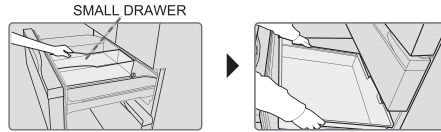

3. Install the white plastic drawer in reverse order, then install the small drawer. Pay attention to the direction when installing the small drawer.

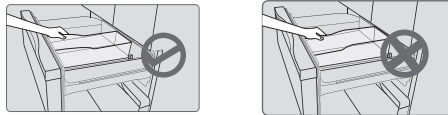

Note

- If the whole set of the drawers has been removed, please refer to the install method of freezer lower drawer.
- The small drawer is applicable to some models only. Pay attention to the direction when installing the small drawer. It can not be closed if installed in reverse direction.

The drawer(top) of freezer compartment

- Pull the drawer all the way out, then lift the white plastic drawer to take it out.
- Install the white plastic drawer in the reverse order.

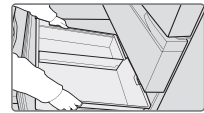

Dismantle and Cleaning of Ice Maker, Ice Bin and Small Drawer

1. Pull out the ice maker, ice bin and small drawer beside them.
2. Wash the ice maker, ice bin and small drawer with water, wipe them with a clean soft cloth.
3. Reassemble in the reverse direction.

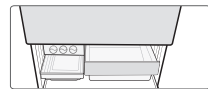

How to dismantle parts

The drawer (bottom) of freezer compartment

1. Pull the drawer of the freezer (lower) all the way out;
2. Remove the transparent shallow drawer.
3. Lift the whole set of drawer and pull out to remove it;

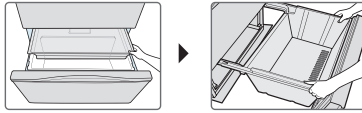

4. Install the whole set of drawer, keeping the rollers of the drawer underneath the rollers of the compartment;

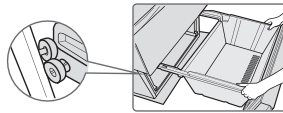

5. Install the transparent shallow drawer.

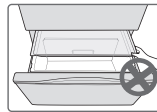
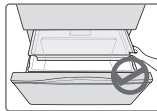

Note

The transparent shallow drawer is applicable to some models only. Pay attention to the direction when installing the transparent shallow drawer. It can not be closed if installed in the reverse direction.

Cleaning of Door and Drawer Gaskets

Dirty door seals will get aged and damaged easily and that will cause cold air leakages, so the gaskets of door and drawer should always be clean

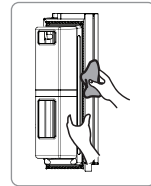

Lamp Replacement

- If LED lamp is damaged, it should be replaced by the service center instead of on your own.

Cleaning

It is important that your refrigerator be kept clean to prevent undesirable odors. Spilled food should be wiped up immediately, since it may acidify and stain plastic surfaces if allowed to settle.

Before cleaning

Be sure to unplug the power.

Exterior

Use a lukewarm solution of mild soap or detergent to clean the durable finish of your refrigerator.

Wipe with a clean damp cloth and then dry.

For products with a stainless steel exterior, use a clean sponge or soft cloth and a mild Detergent in warm water.

Do not use abrasive or harsh cleaners.

Dry thoroughly with a Soft cloth.

Do not use appliance wax, bleach, or other products containing chlorine on stainless steel.

Interior

Regular cleaning is recommended. Wash all compartments a baking soda solution or a mild detergent and warm water. Rinse and dry.

After cleaning

Please verify that the power cord is not damaged, power plug is not overheated, or power plug is well inserted into the power consent.

WARNING

Always remove power cord from the wall outlet prior to cleaning in the vicinity of electrical parts (lamps, switches, controls, etc.).

Wipe up excess moisture with a sponge or cloth to prevent water or liquid from getting into any electrical part and causing an electric shock.

Never use metallic scouring pads, brushes, coarse abrasive cleaners, strong alkaline solutions, flammable or toxic cleaning liquids on any surface.

Do not touch frozen surfaces with wet or damp hands, because damp object will stickor adhere to extremely cold surfaces.

General information

Vacation time

During average length vacations, you will probably find it best to leave the refrigerator in operation. Place freezable items in freezer for longer life.

When you plan not to operate, remove all food, disconnect the power cord, clean the interior thoroughly, and leave each door OPEN to prevent odor formation.

When the ice maker is not to be used for a long time

- Discard the water in the water tank;
- Remove the ice cubes and water in the ice bin;

Power failure

Most power failures that are corrected in an hour or two will not affect your refrigerator temperatures.

However, you should minimize the number of door openings while the power is off.

If you move

Remove or securely fasten down all loose items inside the refrigerator.

To avoid damaging the height adjusting screws, turn them all the way into the base.

Anti condensation pipe

The outside wall of the refrigerator cabinet may sometimes get warm, especially just after installation.

Don't be alarmed. This is due to the anti-condensation pipe, which pumps hot refrigerator to prevent "sweating" on the outer cabinet wall.

WARNING

In case the lamp is damaged, contact service center to replace it. Never replace it by yourself.

Trouble shooting

Before calling for service, review this list. It may save you both time and expense. This list includes common occurrences that are not the result of defective workmanship or materials in this appliance.

Occurrence	Possible cause	Solution
Runing of refrigerator		
Refrigerator does not run	Refrigerator is in defrost cycle.	This is normal for a fully automatic defrosting refrigerator. The defrost cycle occurs periodically.
	Plug at wall outlet is disconnected.	Make sure plug is tightly pushed into outlet.
	Power outage. Check house lights.	Call local electric company.
Refrigerator runs too much or too long	Refrigerator is larger than the previous one you owned.	This is normal. Larger, more efficient units run longer in these conditions.
	Room or outside weather is hot.	It is normal for the refrigerator to work longer under these conditions.
	Refrigerator has recently been disconnected for a period of time.	It takes some hours for the refrigerator to cool down completely.
	Large amounts of warm or hot food may have been stored recently.	Wait for a while until the refrigerator compartment, multi-use compartment and freezer compartment reach the set temperature.
	Doors are opened too frequently or too long.	Warm air entering the refrigerator causes it to run longer. Open the door less often.
	Gaps may be formed on the refrigerator compartment door, multi-use compartment drawer or freezer compartment drawer	Make sure the refrigerator is level. Keep food and containers from blocking door. See problem section. OPENING/CLOSING of doors.
	Refrigerator control is set too cold.	Set the refrigerator control to a warmer setting until the refrigerator temperature is satisfactory.
	The gaskets of the refrigerator compartment door, multi-use compartment drawer or freezer compartment drawer is dirty, worn or deformed.	Clean or change gasket. Leaks in the door seal will cause refrigerator to run longer in order to maintain desired temperatures.
	Thermostat is keeping the refrigerator at a constant temperature.	This is normal. Refrigerator goes on and off to keep the temperature constant.

Trouble shooting

Occurrence	Possible cause	Solution
Temperatures are too cold		
The freezer compartment is too cold but the temperatures in other compartments are normal	Freezer temperature is set too cold.	Set the freezer control to a warmer setting until the freezer temperature is satisfactory.
The refrigerator compartment is too cold but the temperatures in other compartments are normal	Refrigerator temperature is set too cold.	Set the refrigerator control to a warmer setting.
The multi-use compartment is too cold but the temperatures in other compartments are normal	Multi-use compartment temperature is set too cold.	Set the multi-use control to a warmer setting.
Temperatures are too warm		
The temperature in refrigerator compartment, multi-use compartment or freezer compartment is too high	Freezer temperature is set too warm.	Set the freezer temperature to a colder setting until the freezer temperature is satisfactory.
	Multi-use compartment temperature is set too warm.	Set the multi-use compartment temperature to a colder setting until the multi-use compartment temperature is satisfactory.
	Refrigerator control is set too warm. Refrigerator control has some effect on freezer temperature.	Set the refrigerator temperature to a colder setting until the refrigerator temperature is satisfactory.
	Doors are opened too frequently or too long.	Warm air enters the refrigerator/ freezer whenever the door is opened. Open the door less often.
	Door is slightly open.	Close the door completely.
	Large amounts of warm or hot food may have been stored recently.	Wait until the refrigerator or freezer has a chance to reach its selected temperature.
	Refrigerator has recently been disconnected for a period of time.	A refrigerator requires some hours to cool down completely.
The refrigerator compartment is too warm but the temperatures in other compartments are normal	The refrigerator compartment is set to a high temperature or in refrigerator compartment ECO state.	Set the refrigerator control to a colder setting.
The multi-use compartment is too warm but the temperatures in other compartments are normal	The multi-use compartment is set to a high temperature or in multi-use compartment ECO state.	Set the multi-use control to a colder setting.

Trouble shooting

Occurrence	Possible cause	Solution
Sound and noise		
Louder sound levels when refrigerator is on.	Today's refrigerators have increased storage capacity and maintain more even temperatures.	It is normal for sound levels to be higher.
Louder sound levels when compressor comes on.	Refrigerator operates at higher pressures during the start of the ON cycle.	This is normal. The sound will level off as the refrigerator continues to run.
Vibrating or rattling noise.	Floor is uneven or weak. Refrigerator rocks on the floor when it is moved slightly.	Be sure floor is level and solid and can adequately support refrigerator.
	Items placed on the top of the refrigerator are vibrating.	Remove items.
	Dishes are vibrating on the shelves in the refrigerator.	It is normal for dishes to vibrate slightly. Move dishes slightly. Make sure refrigerator is level and firmly set on floor.
	Refrigerator is touching wall or cabinets.	Move refrigerator so that it does not touch the wall or refrigerator.
Water/Moisture /Ice inside refrigerator		
Moisture collects on the inside walls of the refrigerator.	The weather is hot and humid which increases the rate of frost buildup and internal sweating.	This is normal.
	Door is slightly open.	See problem section opening/closing of doors.
	Door is opened too often or too long.	Open the door less often.
Water/Moisture /Ice outside refrigerator		
Moisture forms on the outside of the refrigerator or between doors.	Weather is humid.	This is normal in humid weather. When humidity is lower, the moisture should disappear.
	Door is slightly open, causing cold air from the inside the refrigerator to meet warm air from the outside.	This time, close the door completely.

Trouble shooting

Occurrence	Possible cause	Solution
Odors in refrigerator	Interior needs to be cleaned.	Clean interior with sponge, warm water and baking soda.
	Food with strong odor is in the refrigerator.	Cover food completely.
	Some containers and wrapping materials produce odors.	Use a different container or brand of wrapping materials.
Opening/Closing of doors/Drawers		
Door(s) will not close.	Food package is keeping door open.	Move packages that keep door from closing.
The door or drawer is not closed tightly	The door or drawer is closed with so much force that other drawers and door are opened.	Close the door or drawer gently.
	Refrigerator is not level. It rocks on the floor when it is moved slightly.	Adjust the height adjusting screw.
	Floor is uneven or weak. Refrigerator rocks on the floor when it is moved slightly.	Be sure floor is level and can adequately support refrigerator. Contact carpenter to correct sagging or sloping floor.
	Refrigerator is touching wall or cabinets.	Move refrigerator.
The drawer is hard to pull out or can not be closed tightly	The drawer is stuck by packing bag or the food in the drawer is too heavy.	Remove the food that blocks the drawer or reduce the amount of food in the drawer.
	Track that drawer slides on is dirty.	Clean drawer and track.
Ice maker problems		
	The ice cubes have an odor.	<ul style="list-style-type: none"> • Check if the ice cubes are tainted by foods with strong odor in the compartment. • The interiors of ice bin and the unit need cleaning.

Smart Diagnosis
(Only apply for some Models)



Should you experience any problems with your refrigerator, it has the capability of transmitting data via your telephone to the LG service center. This gives you the capability of speaking directly to our trained specialists. The specialist records the data transmitted from your machine and uses it to analyze the issue, providing a fast and effective diagnosis.

If you experience problems with your refrigerator, call to the LG service center. Only use the Smart Diagnosis feature when instructed to do so by the LG call center agent. The transmission sounds that you will hear are normal and sound similar to a fax machine.

Smart Diagnosis cannot be activated unless your refrigerator is connected to power. If your refrigerator is unable to turn on, then troubleshooting must be done without using Smart Diagnosis.

Using Smart Diagnosis

First, call to the LG service center. Only use the Smart Diagnosis feature when instructed to do so by the LG call center agent.

1. Lock the display. To lock the display, press and hold the Lock button for three seconds. (If the display has been locked for over five minutes, you must deactivate the lock and then reactivate it.)



2. Open the right refrigerator door.

3. Hold the mouthpiece of your phone in front of the speaker that is located on the right hinge of the refrigerator door, when instructed to do so by the call center.



4. Press and hold the Freezer Temperature button for three seconds while continuing to hold your phone to the speaker.

5. After you hear three beeps, release the Freezer Temperature button.



6. Keep the phone in place until the tone transmission has finished. This takes about 3 seconds, and the display will count down the time. Once the countdown is over and the tones have stopped, resume your conversation with the specialist, who will then be able to assist you in using the information transmitted for analysis.

NOTE

- For best results, do not move the phone while the tones are being transmitted.
- If the call center agent is not able to get an accurate recording of the data, you may be asked to try again.
- Call quality differences by region may affect the function.
- Use the home telephone for better communication performance, resulting in better service.
- Bad call quality may result in poor data transmission from your phone to the machine, which could cause Smart Diagnosis to not work properly.