



OWNER'S MANUAL

AIR CONDITIONER



Read this owner's manual thoroughly before operating the appliance and keep it handy for reference at all times.

TYPE : Single / Multi Ceiling Cassette 4-Way

EN ENGLISH FR FRANÇAIS ES ESPAÑOL

TABLE OF CONTENTS

3 SAFETY INSTRUCTIONS

- 3 READ ALL INSTRUCTIONS BEFORE USE
- 3 IMPORTANT SAFETY INSTRUCTIONS

8 PRIOR TO OPERATION

- 8 Preparing for operation

9 OPERATION

- 9 Parts and Functions
- 10 Wireless Remote Control
- 12 Using the Mode Function
- 13 Using the Auto Operation Function
- 14 Using the Temperature Setting Function
- 15 Using the Fan Speed Function
- 15 Using the Air Flow Direction Function
- 17 Using the Optional Function
- 19 Using Special Functions
- 21 Timer Functions
- 22 Forced Operation
- 22 Test Operation
- 22 Auto Restart Function

23 MAINTENANCE

- 23 Cleaning the Air Filter
- 24 Cleaning the Deodorization Filter/PM1.0 Filter (Optional)
- 26 Cleaning the PM1.0 Sensor (Optional)
- 27 Tips for Maintenance

28 TROUBLESHOOTING

- 28 Before Calling for Service

29 LIMITED WARRANTY (USA)

30 LIMITED WARRANTY (CANADA)

AN ARBITRATION PROVISION

By using this product, you agree that all disputes between you and LG arising out of or relating in any way to this product (including but not limited to warranty disputes) shall be resolved exclusively through binding arbitration on an individual basis. The terms of the arbitration agreement (including details on the procedure for resolving disputes) is available at www.lg.com/us/arbitration (USA) or www.lg.com/ca_en/arbitration (Canada) and/or your owner's manual or warranty.

SAFETY INSTRUCTIONS

READ ALL INSTRUCTIONS BEFORE USE

Your safety and the safety of others are very important.

We have provided many important safety messages in this manual and on your appliance. Always read and follow all safety messages.



This is the safety alert symbol.

This symbol alerts you to potential hazards that can kill or injure you and others.

All safety messages will follow the safety alert symbol and either the word WARNING or CAUTION. These words mean:



WARNING

Failure to follow these instructions could result in death or serious injury.



CAUTION

Failure to follow these instructions could result in minor or moderate injury or damage to the product.

All safety messages will tell you what the potential hazard is, inform you as to how to reduce the chance of injury, and tell you what may happen if the instructions are not followed.

IMPORTANT SAFETY INSTRUCTIONS



WARNING

To reduce the risk of explosion, fire, death, electric shock, injury or scalding to persons when using this product, follow basic precautions, including the following:

- Installation or repairs done by unauthorized persons can pose hazards to you and others.
- Installation MUST conform to the local building codes or, in the absence of local codes, the National Electrical Code NFPA 70/ANSI C1-1003 or current edition and Canadian Electrical Code Part1 CSA C.22. 1.
- The information contained in the manual is intended for use by a qualified service technician who is familiar with the safety procedures and equipped with the proper tools and test instruments.
- Failure to read and follow all instructions in this manual can result in equipment malfunction, property damage, personal injury and/or death.
- When the power cord is to be replaced, the replacement work shall be performed by authorized personnel using only genuine replacement parts.
- This appliance is not intended for use by persons (including children) with reduced physical, sensory or mental capabilities, or lack of experience and knowledge, unless they have been given supervision or instruction concerning the use of the appliance by a person responsible for their safety. Children should be supervised to ensure that they do not play with the appliance.

 **WARNING****Installation**

- Contact the dealer to have the air conditioner installed.
 - Incomplete installation performed by yourself may result in a water leakage, electric shock, and fire.
- Check the foundation for damaged on a continuous basis, especially if it has been in use for a long time.
 - It may cause injury or damage to the unit or other property.
- Contact the dealer for repairs, maintenance and to reinstall the air conditioner.
 - Incomplete installation performed by yourself may result in a water leakage, electric shock, and fire.
- Be sure to only use accessories made by LG which are specifically designed for use with the equipment and have them installed by a professional.
 - Improper installation or attachment of equipment or accessories could result in electric shock, a short circuit, leaks, fire or other damage to the equipment.
- In the case of refrigerant leakage, consult the dealer. When installing the air conditioner in a small room, it is necessary to take proper measures so that even when it leaks, the amount of any leaked refrigerant does not exceed the limiting concentration even when it leaks. If the refrigerant leakage exceeds the limiting concentration level, an oxygen deficiency-related accident may occur.
 - There is a risk of asphyxiation which could lead to serious injury or death.
- Do not install the unit in an area where there are flammable materials.
 - There is a risk of explosion that could result in serious injury or death.
- Use a vacuum pump or insert (nitrogen) gas when performing a leakage test or air purge. Do not allow air etc. to enter the refrigerant circuit (piping). Never use refrigerants that are not specified on the specification. label and in the manuals.
 - There is a risk of death, injury, fire or explosion.

Power

- Do not attempt to do electrical work or grounding work unless you are licensed to do so. Consult with the dealer for electrical work and grounding work.
 - There is a risk.
- Do not modify or extend the power cable.
 - There is risk of fire or electric shock.
- Be sure to establish an earth.
 - There is risk of fire or electric shock.
- Be sure to install an earth leakage breaker.
 - There is risk of fire or electric shock.
- Always install a dedicated circuit and breaker.
 - Improper wiring or installation may cause fire or electric shock.
- Do not turn on the breaker or power if the front panel, cabinet, top cover, or control box cover are removed or opened.
 - Doing so could cause fire, electric shock, explosion or death.
- Do not use a defective or underrated circuit breaker. Use this appliance on a dedicated circuit.
 - There is a risk of fire or electric shock.
- Consult with the installation contractor for cleaning or maintenance. Turn off all electrical power before doing any cleaning or maintenance.
 - There is a risk of water leakage, electric shock or serious injury.
- Take care to ensure that the power cable cannot be pulled out or damaged during operation.
 - There is a risk of fire or electric shock.
- Do not place anything on the power cable.
 - There is a risk of fire or electric shock.

- Do not turn off the power immediately after stopping operation. Always wait for at least five minutes before turning off the power.
 - Otherwise, water leakage may occur.
- Indoor/outdoor wiring connections must be secured tightly and the cable should be routed properly so that there is no force pulling the cable from the connection terminals.
 - Improper or loose connections can cause heat generation or fire.
- Do not touch (operate) the product with wet hands.
 - There is a risk of electrical shock.
- Never let the indoor unit or the remote controller get wet.
 - Water can cause an electric shock or a fire.
- Do not let the air conditioner run while a door or window is open on a day with high humidity. This could result in excessive moisture and water damage.
 - Excess moisture may collect and cause water damage to walls or furniture.
- If there are any abnormalities in the operation of the air conditioner such as strange sounds, smoke or fire, turn off the power and contact the dealer immediately.
 - There is a risk of severe injury or death.

Operation

- Be sure to use only those parts which are listed in the SVC parts list. Never attempt to modify the equipment.
 - The use of inappropriate parts can cause an electrical shock or fire.
- Do not install the air conditioner at any place where flammable gas may leak out. If the gas leaks out and stays around the air conditioner, a fire may break out.
 - There is a risk of explosion, fire and serious injury.
- Never use flammable spray such as hair spray, lacquer or paint near the unit.
 - Flammable spray may cause a fire.
- If equipment utilizing a burner is used in the same room as the air conditioner, there is the danger of oxygen deficiency, which could lead to asphyxiation. Be sure to ventilate the room sufficiently to avoid this hazard.
 - There is a risk of serious injury or death.
- Do not put fingers or other objects into the air inlet or air outlet. Never remove the fan guard of the unit.
 - The fan rotates at a high speed and will cause injury.
- Never sprinkle or spill water or liquids on unit.
 - Doing so could cause fire, failure of the product, or electric shock.
- Take care to ensure that nobody can step on or fall onto the outdoor unit.
 - This could result in personal injury and product damage.
- Stop operation and close all window in storm or hurricane. If possible, remove the product from the window before the hurricane arrives.
 - There is a risk of property damage, product failure, or electric shock.
- If the product becomes soaked (flooded or submerged), contact the dealer.
 - There is a risk of fire or electric shock.
- Do not use the product in a tightly closed space for a long time.
 - Doing so could result in a state of oxygen deficiency.

Maintenance

- The heat exchanger fins are sharp edges enough to cut. To avoid injury, wear gloves or cover the fins while working around them.
- Tear apart and throw away plastic packaging bags so that children will not play with them.
 - Children playing with plastic bags are at risk of death by suffocation.
- Safely dispose of the packing materials. Packing materials, such as nails and other metal or wooden parts.
 - These materials could cause puncture wounds or other injuries.

 **CAUTION****Installation**

- If the refrigerant gas leaks during the installation, ventilate the area immediately.
 - Such leakage it can be harmful for your health.
- Always check for gas (refrigerant) leakage after installation or repair of product.
 - Low refrigerant levels may cause product failure.
- Keep the product level, even when installing it.
 - This will help to avoid vibration or water leakage.
- Use two or more people to lift and transport the product.
 - This will help to avoid personal injury.
- Installation work must be performed in accordance with the National Electric Code by qualified and authorized personnel only.
- Do not place objects in direct proximity of the outside unit. Do not let leaves and other debris accumulate around the unit. Leaves are a hotbed for small animals, which can enter the unit. Once inside the unit, these animals can lead to the unit malfunctioning, and end up causing in smoke or fire when they make contact with electrical parts.
 - There is a risk of fire or electric shock.
- Do not install the product where it will be exposed to sea wind (salt spray) directly.
 - This can cause corrosion on the product. Corrosion, particularly on the condenser and evaporator fins, could cause product malfunction or inefficient operation.

- Make sure that the drainpipe is installed properly to drain water. Arrange the drain hose to ensure smooth drainage.
 - Incomplete drainage may lead to water damage done to the building, furniture, etc. If no water is discharged from the drainpipe while the air conditioner or heat pump is in the cooling mode, it may be because the drainpipe has become clogged with dust or dirt, and could result in water leakage in the indoor unit. In such a situation, stop operating the air conditioner or heat pump and contact the dealer.
- Do not install the product where the noise or hot air from the outdoor unit could be harmful to your immediate surroundings.
 - Improper placement could cause problems for your neighbors.
- The Limited Warranty is void and of no effect, and LG will have no liability hereunder to any Customer or third party, to the extent any of the following occur: acts, omissions, and conduct of any and all third parties including, but not limited to, the installing contractor and any repairs, service or maintenance by unauthorized or unqualified persons.
- Do not install the unit in potentially explosive atmospheres.

Operation

- If refrigerant gas leaks while the unit is being repaired do not touch the leaking refrigerant gas.
 - The refrigerant gas can cause frostbite (cold burn)
- Do not mix air or gases other than the specified refrigerant used in the system.
 - Air entering the refrigerant system can lead to excessively high pressure causing equipment damage or injury.
- Make sure that there are no obstacles close to the outdoor unit. The presence of obstacles close to the outdoor unit may reduce the performance of outdoor unit or increase its operating sound.
 - This could cause product failure.

- Do not use the air conditioner for any other purposes other than comfort cooling or heating. Do not use the unit for cooling precision instruments, food, plants, animals or works of art.
 - Doing so could lead to risk of damage or loss of property.
- Replace all the batteries in the remote control with new ones of the same type. Do not mix old and new batteries or different types of batteries.
 - Doing so could lead to a risk of fire or explosion.
- Do not recharge or disassemble the batteries. Do not dispose of batteries in a fire.
 - They may burn or explode.
- If the liquid from the batteries gets onto your skin or clothes, wash it well with clean water. Do not use the remote if the batteries have leaked.
 - The chemicals in batteries could cause burns or other health hazards.
- If you ingest the liquid from the batteries, brush your teeth and see a doctor. Do not use the remote if the batteries have leaked.
 - The chemicals in batteries could cause burns or other health hazards.
- Do not step on or put anything on the product. (outdoor units)
 - Doing so could lead to a risk of personal injury and product failure.
- The appliance is not intended for use by young children or infirm persons without supervision.
- Do not allow a child to mount on the unit or place any object on it. Do not let children play on and around the unit.
 - Falling or tumbling may result in injury. If a child touches the unit carelessly, it may result in injury.
- Do not drink the water drained from the product.
 - It is not sanitary and could cause serious health issues.

Maintenance

- Contact the dealer for repair or maintenance.
- Do not wipe the controller operation panel with benzine, thinner, chemical dust cloths, etc. The panel may get discolored or the coating may peel off. If it is very dirty, soak a cloth in water-diluted neutral detergent, squeeze it well and wipe the panel clean. Then wipe it dry with another dry cloth.
 - There is a risk of damage to the plastic parts of the product.
- Do not insert hands or other objects through the air inlet or outlet while the product is operating.
 - There are sharp and moving parts that could cause personal injury.
- Use a firm stool or ladder when cleaning or maintaining the product.
 - Be careful and avoid personal injury.
- Do not touch the metal parts of the product when removing the air filter. They are very sharp!
 - There is a risk of personal injury.
- Do not drink the water drained from the product.
 - It is not sanitary and could cause serious health issues.
- Do not operate the air conditioner when using a room fumigation-type insecticide.
 - Failure to do so could lead to the chemicals becoming deposited in the unit, which could endanger the health of those who are hypersensitive to chemicals.

PRIOR TO OPERATION

Preparing for operation

- 1 Contact an installation specialist for installation.
- 2 Use a dedicated circuit.

Usage

- 1 Being exposed to direct airflow for an extended period of time could be hazardous to your health. Do not expose occupants, pets, or plants to direct airflow for extended periods of time.
- 2 Due to the possibility of oxygen deficiency, ventilate the room when used together with stoves or other heating devices.
- 3 Do not use this air conditioner for non-specified special purposes (e.g. preserving precision devices, food, pets, plants, and art objects). Such usage could damage the items.
- 4 While using the remote control, refer the user manual of that particular remote controller.

Cleaning and maintenance

- 1 Do not touch the metal parts of the unit when removing the filter. Injuries can occur when handling sharp metal edges.
- 2 Do not use water to clean inside the air conditioner. Exposure to water can destroy the insulation, leading to possible electric shock.
- 3 When cleaning the unit, first make sure that the power and breaker are turned off. The fan rotates at a very high speed during operation. There is a possibility of injury if the unit's power is accidentally triggered on while cleaning inner parts of the unit.

Service

For repair and maintenance, contact your authorized service dealer.

PRECAUTION

- Contact an authorized service technician for repair or maintenance of this unit.
- Contact an installation specialist for installation of this unit.
- The air conditioner is not intended for use by young children or disabled individuals without supervision.
- Young children should be supervised to ensure that they do not play with the air conditioner.
- When the power cord needs to be replaced, replacement work should be performed by authorized personnel only using only genuine replacement parts.
- Installation work must be performed in accordance with the National Electric Code by qualified and authorized personnel only.

READ THIS MANUAL

Inside you will find many helpful hints on how to properly use and maintain your air conditioner. Just a little preventive care on your part can save you a great deal of time and money over the life of your air conditioner.

You'll find many answers to common problems in the chart of troubleshooting tips. If you review our chart of Troubleshooting Tips first, you may not need to call for service at all.

FOR YOUR RECORDS

Write the model and serial numbers here.

Model	
Serial	

You can find them on a label on the side of each unit.

Dealer's Name	
Date Purchased	

OPERATION

Parts and Functions

Indoor Unit

Type 1

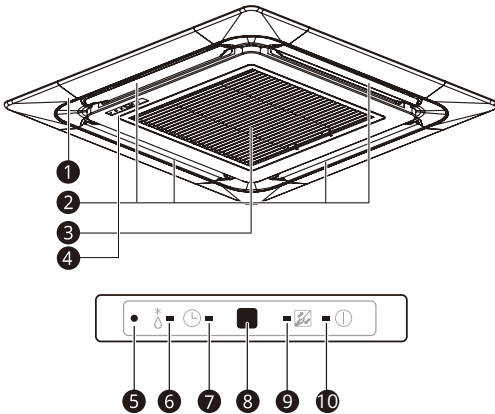

- | | |
|-------------------|---------------------------|
| ① Front Panel | ② Air Discharge |
| ④ Signal receiver | ⑤ Forced Operation Button |
| ⑦ Timer | ⑧ Remote Sensor |
| ⑩ On/Off | |

Type 2

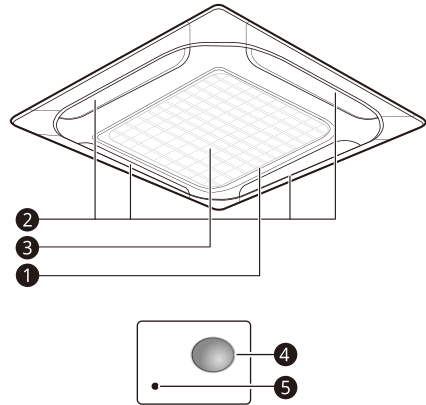

- | |
|----------------|
| ③ Air Inlet |
| ⑥ Defrost Mode |
| ⑨ Filter Sign |

NOTE

- The number and location of operation lamps may vary according to the model of the air conditioner.
- The features may differ based on the type of model.



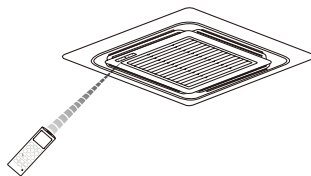

Operating Method

- 1 The signal receiver is inside the unit.
- 2 Aim the remote controller towards the unit to operate it.
 - There should not be any obstacles blocking the remote controller.



Operation Indication Lamps

Type 1

	On/Off	Lights up during the system operation.
	Filter Sign	Lights up after 2 400 hours from the time of first operating unit.
	Timer	Lights up during Timer operation.
	Defrost Mode	Lights up during Defrost Mode or Hot Start operation. (Heat pump model only)
	Forced Operation Button	To operate the unit when the remote control can't be used for any reason.

Type 2

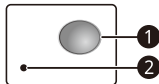

Description	Lamp Color
Cooling mode	Green
Heating mode	Green
Time to clean filter in cooling/heating mode	Yellowish Green
Time to clean filter when product is not operating	Orange
Hot start or defrost mode before starting heating mode	Green
When reservation set on	Yellowish Green

- ① Lamp
- ② Forced Operation Button

※ The Clean Filter indicator lamp does not light up starting from the corresponding product manufacturing number (after Oct. 2021).

NOTE

- Hot start operation
 - Stops the indoor fan in the heating operation for a few minutes to prevent cold air from blowing out from unit.
- In defrost mode, the unit stops the heating operation for a few minutes to remove ice formations from the heat exchanger coils in order to maintain efficiency.

Wireless Remote Control

Inserting Batteries

- 1 Remove the battery cover by pulling it according to the arrow direction.
- 2 Insert new batteries making sure that the (+) and (-) of battery are installed correctly. (Battery Size = AAA).
- 3 Reattach the cover by sliding it back into position.

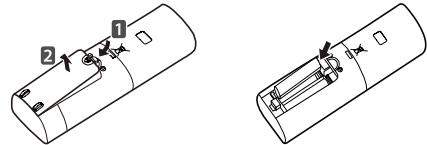

NOTE

- When using or replacing batteries, make sure that they are both the same type.
- If the system is not going to be used for a long time, remove the batteries to save their working life.
- If the display screen of the remote controller starts, fading replace both of the batteries.

Installing the Remote Control Holder

- 1 Choose a suitable place where its safe & easy to reach.
- 2 Fix the firmly to the wall with the supplied screws.
- 3 Slide the remote controller inside the holder.

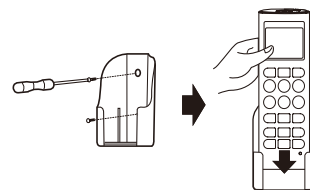

NOTE

- The remote controller should never be exposed to direct sunlight.
- The signal transmitter & receiver should always be clean for proper communication. Use a soft cloth to clean them.
- If other appliances are accidentally affected by the remote controller, change their position or consult your serviceman.

Using Wireless Remote Control

You can operate the air conditioner more conveniently with the remote control.

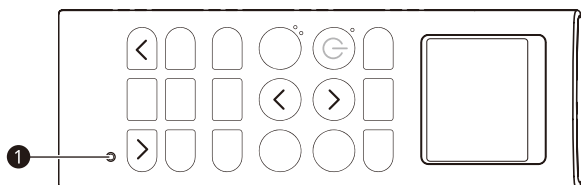

Button	Display Screen	Description
	-	Used to turn on/off the unit.
AIR PURIFY		Used to start or stop the air purification function.
PLASMA		Used to start or stop the plasma-purification function.
VANE ANGLE		Used to set each vane angle.
AIR FLOW		Used to set airflow.
		Used to select the room temperature.
MODE	-	Used to select the operation mode.
JET MODE		To change room temperature quickly.
JET COOL		
FAN SPEED	-	To adjust the fan speed.
FUNC.	-	Used to set or clear additional function.
		To adjust the air flow direction vertically or horizontally.
ROOM TEMP		Used to check the room temperature.
SLEEP		Used to set the time for the sleep function.
ON	-	Used to set the start time.
OFF	-	Used to set the stop time.
	-	Used to set the timer. Used to adjust the brightness. Used to check the room temperature. (If it is not time adjust mode)
SET/CLEAR	-	Used to set/clear the timer. Used to set the current time. (hold button for 3 seconds)
1 RESET	-	To initialize the remote control settings.



NOTE

- Depending on the product type, some functions may not be available and displayed.
- Some products don't receive the wired signals.
- When using the simultaneous operation system, the system will operate approximately 1 - 2 minutes after pressing the remote controller button.
- The displayed temperature can be different from the actual room temperature if the remote controller is installed somewhere exposed to direct sunlight or is nearby a heat source.
- Depending on the product, wireless and wired remote control are optional or basic.
- Heating Mode is not available for Cooling only Models.
- Buttons may be changed according to the type of model.

Using the Mode Function

Cooling Mode

This cools the room with a comfortable and clean wind.

- 1 Turn the appliance on.
- 2 Press **MODE** button repeatedly to select the Cooling Mode.
 -  is displayed on the display screen.
- 3 Press  or  button to set the desired temperature.
- 4 Press **FAN SPEED** button repeatedly to adjust the fan speed.

NOTE

- Press the **ROOM TEMP** button to check the Room temperature.
- When setting the desired temperature higher than the current room temperature, the unit will produce only ventilation wind.

Power Cooling Mode

This cools the room with a comfortable and clean wind.

- 1 Turn the appliance on.
- 2 Press **MODE** button repeatedly to select the Cooling Mode.
- 3 Press **JET MODE** or **JET COOL** button.
 -  is displayed on the display screen.

NOTE

- To cancel the Power Cooling Mode, Press the **JET MODE** or **JET COOL** button, the **FAN SPEED** button or the **ROOM TEMP** button.
- This rapidly lowers the room temperature.
- Partial appliance has no Power Cooling function.
- The unit will operate at a high fan speed in cooling mode.
- The feature may be changed according to the type of model.

Dehumidification Mode

It removes humidity while slightly cooling the air.



- 1 Turn the appliance on.
- 2 Press **MODE** button repeatedly to select the Dehumidification Mode.
 -  is displayed on the display screen.
- 3 Press **FAN SPEED** button repeatedly to adjust the fan speed.

NOTE

- The temperature setting can not be adjusted when this mode is operating.
- During rainy seasons or in high-humidity climates, it is possible to simultaneously operate the dehumidifier and cooling mode to remove humidity effectively.
- The menu item of wind powerfulness might not be partially selected according to the product.

Heating Mode

This supplies warm wind to the inside of the building.

- 1 Turn the appliance on.
- 2 Press **MODE** button repeatedly to select the Heating Mode.
 -  is displayed on the display screen.
- 3 Press  or  button to set the desired temperature.
- 4 Press **FAN SPEED** button repeatedly to adjust the fan speed.

NOTE

- Press the **ROOM TEMP** button to check the Room temperature.
- When setting the desired temperature lower than the room temperature, the unit will produce only ventilation wind.
- Heating Mode is not available for Cooling only models.
- To check the indoor temperature, press the room temperature button.

Power Heating Mode

- 1 Turn the appliance on.
- 2 Press **MODE** button repeatedly to select the Heating Mode.
- 3 Press **JET MODE** button.
 - **P0** is displayed on the display screen.

NOTE

- Heating Mode is not available for Cooling only models.
- Some functions may not be supported, depending on the model.

Fan Mode

- 1 Turn the appliance on.
- 2 Press **MODE** button repeatedly to select the Fan Mode.
 -  is displayed on the display screen.
- 3 Press **FAN SPEED** button repeatedly to adjust the fan speed.

NOTE

- Natural wind based on chaos logic
 - For a fresher feeling than other fan speeds, press the Indoor Fan Speed Selector and set to chaos mode. In this mode, the wind blows like a natural breeze by automatically changing fan speed based on the chaos logic.
- During Fan Mode
 - The outdoor compressor doesn't work. Have a function to circulate the indoor as it sends out the air that doesn't have much temperature difference with indoor.

Using the Auto Operation Function

Auto Operation Mode



This mode automatically sets the fan speed and temperature depending on the room temperature.

Cooling Only Model

In this mode, you cannot adjust the fan speed, but you can set the air deflector to rotate automatically.

- 1 Turn the appliance on
- 2 Press **MODE** button repeatedly to select the Auto Operation Mode.
 -  is displayed on the display screen.



- 3 Press  or  button to set the desired temperature.
 - Please select the code depend on your feeling.





Code	Description
2	Cold
1	Slightly cool
0	Neutral
-1	Slightly warm
-2	Warm

Cooling & Heating Model

This mode changes the mode automatically to maintain the set temperature at ± 2 °C (4 °F)

- 1 Turn the appliance on.
- 2 Press **MODE** button repeatedly to select the Auto Operation Mode.
 -  is displayed on the display screen.



- 3 Press  or  button to set the desired temperature.
 - Setting temp range: 18 °C ~ 30 °C (64 °F ~ 86 °F)
- 4 Press **FAN SPEED** button repeatedly to adjust the fan speed.

Auto Changeover Mode - Setting the Mode Change Temperature

Cooling & Heating Model

The Mode Change Temperature is the difference of temperature when from cooling mode to heating mode or from heating mode to cooling mode.

- 1 In Auto Operation Mode, Press the **FUNC.** button to select Setting the Mode Change Temperature.
- 2 Press \uparrow or \downarrow button to set desired Mode Change Temperature.
 - Default value is 2 °C (4 °F)
 - Setting temp range: 1 °C ~ 7 °C (2 °F ~ 14 °F)



NOTE

- When setting temperature is 25 °C (76 °F) and room temperature is 20 °C (68 °F), then operating mode is heating. If you set the mode change temperature to 2 °C (4 °F), when the room temperature up to 27 °C (25 °C + 2 °C) (80 °F (76 °F + 4 °F)), the unit start cooling operation.

Using the Temperature Setting Function

Temperature Setting

Use this function to adjust the desired temperature.

- \uparrow : Increase 1 °C or 1 °F each time pressed.
- \downarrow : Decrease 1 °C or 1 °F each time pressed.

NOTE

- 5 °C (41 °F) is proper for the difference between room and outside temperature.
- Cooling operation
 - The cooling mode doesn't work if the desired temperature is higher than room temperature. Please lower the desired temperature.
 - Setting temp range: 18 °C ~ 30 °C (64 °F ~ 86 °F)
- Heating operation
 - The heating mode doesn't work if the desired temperature is lower than room temperature. Please increase the desired temperature.
 - Setting temp range: 16 °C ~ 30 °C (60 °F ~ 86 °F)
 - When pressing the **FAN SPEED** button of the remote controller for approx. 3 seconds, the room temperature will be displayed for about 5 seconds before returning to the previous display panel.
- Some functions may not be supported, depending on the model.

Switching Between Celsius/ Fahrenheit

- Press and hold the **ROOM TEMP** or **FUNC.** button long for 5 seconds to change from Celsius to Fahrenheit or from Fahrenheit to Celsius.

NOTE

- Some functions may not be supported, depending on the model.

Using the Fan Speed Function

Adjusting the Fan Speed

- 1 Turn the appliance on.
- 2 Press **FAN SPEED** button repeatedly to adjust the fan speed.



NOTE

- The menu item might not be partially selected according to product function.
- The feature may be changed according to the type of model.

Using the Air Flow Direction Function

Up/Down Airflow Direction Control (Optional)

The up/down airflow (Vertical Airflow) can be adjusted by using the remote controller.



- 1 Turn the appliance on.
- 2 Press  button.
 - The louvers will swing up and down.
- 3 Press  button again to set the vertical louver at the desired airflow direction.

NOTE

- If you press  button, the horizontal airflow direction is changed automatically based on the Auto Swing algorithm to distribute the air in the room evenly and at the same time to make the human body feel more comfortable, as if enjoying a natural breeze.
- Always use the remote controller to adjust the up/down airflow direction. Manually moving the vertical airflow direction louver by hand, could damage the air conditioner.
- When the unit is shut off, the up/down airflow direction louver will close the air outlet vent of the system.
- Some functions may not be supported, depending on the model.

Left/Right Airflow Direction Control (Optional)

The left/right (horizontal) airflow can be adjusted by using the remote control.

- 1 Turn the appliance on.
- 2 Press  button.
 - The louvers will swing left and right.
- 3 Press  button again to set the horizontal louver at the desired airflow direction.

NOTE

- Some functions may not be supported, depending on the model.

Indirect Wind (Optional)

It adjusts the wind direction to indirect wind.

- 1 Turn the appliance on.
- 2 Press **AIR FLOW** button repeatedly until  icon displayed.
- 3 Press **SET/CLEAR** button to set or cancel this function.

NOTE

- Some functions may not be supported, depending on the model.

Direct Wind (Optional)

It adjusts the wind direction to direct wind.

- 1 Turn the appliance on.
- 2 Press **AIR FLOW** button repeatedly until  icon displayed.
- 3 Press **SET/CLEAR** button to set or cancel this function.

NOTE

- Some functions may not be supported, depending on the model.

Smart Mode (Optional)

It is the function to set the Smart Mode operation of the product.





- 1 Turn the appliance on.
- 2 Press **AIR FLOW** button repeatedly until  icon displayed.
- 3 Press **SET/CLEAR** button to set or cancel this function.

NOTE

- Smart Mode function can only be selected in the cooling and heating modes.
- Smart Mode / Energy Saving Cooling / Refresh Mode functions cannot be set at the same time.
- Some functions may not be supported, depending on the model.

Refresh Mode (Optional)

It is the function to set the Refresh Mode operation of the product.

- 1 Turn the appliance on.
- 2 Press **AIR FLOW** button repeatedly until  icon displayed.
- 3 Press **SET/CLEAR** button to set or cancel this function.
- 4 When set, it is displayed with the animated effect in the order of  →  → .

NOTE

- Refresh Mode function can only be selected in the cooling and heating modes.
- Smart Mode / Energy Saving Cooling / Refresh Mode functions cannot be set at the same time.
- Some functions may not be supported, depending on the model.

Using the Optional Function

Individual Vane Angle Control (Optional)

This is the function that controls the vane angles individually in the ceiling cassette products.

- 1 Press **VANE ANGLE** button.
 - The individual vane angle control symbol will blink.

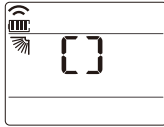

- 2 Set each vane angle by pressing **VANE ANGLE** button.

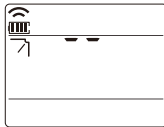

- 3 Press **SET/CLEAR** button to set or cancel this function.

NOTE

- There may be differences between the up/down/left/right buttons on the wireless remote controller and the wind discharge port directions.
- Set the desired angle while checking the movement and angle of the product's vanes.
- Some functions may not be supported, depending on the model.

Air Purification/Plasma Purification (Optional)

- Press **AIR PURIFY** or **PLASMA** button.
 -  is displayed on the display screen.

NOTE

- If you wish to stop, press **AIR PURIFY** or **PLASMA** button again.
- When **AIR PURIFY** button is pressed while the unit is stopped, Air Purification will start independently.
- Plasma filter is technology developed by LG to get rid of dust, pollen, and pet fur in the intake air by generating a plasma of highly charged electrons.
- This function can be used in any operation mode and any fan speed can be used while the plasma filter is functioning.
- Some functions may not be supported, depending on the model.

Smart Indicator (Air Quality) Always On Setting (Optional)

- Press the **AIR PURIFY** button for 3 seconds, Air quality level will always be displayed on Smart Indicator of the product.

NOTE

- Some functions may not be supported, depending on the model.

LCD Luminosity Control (Optional)

It is comfortable when you feel that the display of the unit too bright.

- Press the  button.

Checking the Air Quality Level During Air Purification Operation (Optional)

- Press the **AIR PURIFY** button for 3 seconds, Air quality level will always be displayed on Smart Indicator of the product.

Global

Display Color	Air Quality Level	Concentration of Dust ($\mu\text{g}/\text{m}^3$)	
		PM10	PM2.5/1.0
Green	Good	54 ↓	12 ↓
Yellow	Moderate	55 - 154	13 - 35
Orange	Unhealthy	155 - 254	36 - 55
Red	Poor	255 ↑	56 ↑

China/India

Display Color	Air Quality Level	Concentration of Dust ($\mu\text{g}/\text{m}^3$)	
		PM10	PM2.5/1.0
Green	Good	50 ↓	35 ↓
Yellow	Moderate	51 - 150	36 - 75
Orange	Unhealthy	151 - 250	76 - 115
Red	Poor	251 - 350	116 - 150
Pink	Very poor	351 - 420	151 - 250
Violet	Severe	421 ↑	251 ↑

NOTE

- The dust concentration is displayed from 8 to 999 by the unit of 1.
- The dust concentration referred to the data sheet of the sensor manufacturer.
- The dust concentration criteria for the PM1.0 dust were set based on the same criteria as the PM2.5 dust. (Company standard)
- The dust concentration and level displayed on the product may differ from other measuring instruments or other products.
- The displayed dust concentration values can differ from each other depending on the differences in dust measuring methods and also from the actual dust density.
- The dust concentration evaluation is carried out with our company's standard test dust.
- If you use a product generating steam or fine particles (humidifier, cooking appliances, sprays, etc.), the dust concentration may change.
- The dust concentration may vary depending on the installation environment and surrounding environment.
- It is also affected by sofas, beds, carpets, vacuum cleaners, humidity, smoke, bugs, pets, etc.
- It is affected by construction sites, roadsides and factories.
- Dust concentrations can be measured to be higher in an environment where external air is introduced, such as near the entrance, windows and ventilation openings.
- This is an additional function of the product and may not work in some products.
- The feature may be changed according to the type of model.
- Some functions may not be supported, depending on the model.

How to Set Air Quality Level Color (Optional)

- 1 With the **JET COOL** button pressed, press the reset button.



- 2 By using the \wedge or \vee button, set function code and setting value.

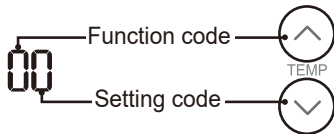

- 3 Press the \odot button toward the indoor unit 1 time.
 - Each countries have different standards for indicating Overall air quality. Please refer to table below.

Value	Step	Overall Air Quality
Type 1 (1 beep)	4 step (For Korea)	Good/Moderate/ Unhealthy/Poor
Type 2 (2 beep)	4 step (For Global)	Good/Moderate/ Unhealthy/Poor
Type 3 (3 beep)	6 step (For China)	Good/Moderate/ Unhealthy/Poor/ Very Poor/ Severe

- 4 Reset the remote controller to use the general operation mode.

NOTE

- The feature may be changed according to the type of model.
- Some functions may not be supported, depending on the model.

Using Special Functions

Setting Special Functions

- 1 Press **FUNC.** button repeatedly to select the desired function.
- 2 Press **SET/CLEAR** button to finish.

NOTE

- Some functions may not be supported, depending on the model.
- Some functions may operate differently from the remote control display.

Canceling Special Functions

- 1 Press **FUNC.** button repeatedly to select the desired function.
- 2 Press **SET/CLEAR** button to cancel the function.

Auto Clean (Optional)

In the Cooling and Dehumidification Mode, moisture is generated inside the indoor unit. This function removes such moisture.

-  is displayed on the display screen.

NOTE

- If you turn off the unit, the fan continues to run for 30 minutes and cleans the inside of the indoor unit.
- Some functions cannot be used while the Auto Clean function is in operation.

Smart Clean (Optional)

The Smart Clean function can be used by setting to manual or automatic.

-  is displayed on the display screen.

Auto Smart Clean Operation

If the accumulated operation time of the product exceeds 30 hours, the Smart Clean automatically starts when the unit is turned off.

Manual Smart Clean Operation

When the unit stop, press the **FUNC.** button to select Smart Clean.

NOTE

- The brush clean a dust from the filter by moving from left to right or from right to left on the filter. The sucked dust is collected into the dust box.
- Some functions may not be supported, depending on the model.

Energy Saving Cooling (Optional)

Energy Saving Cooling is the function to adjust the desired temperature during cooling operation to enhance the comfort of the user and improve the energy saving performance.

-  is displayed on the display screen.

NOTE

- It can be selected only during the cooling operation.
- When pressing Energy Saving Cooling while cooling at 22 °C (71 °F) or lower, it is automatically set to 22 °C (71 °F)
- During the Energy Saving Cooling operation, the temperature on the remote control may be displayed differently from the air conditioner display.
- Smart Mode / Energy Saving Cooling / Refresh Mode functions cannot be set at the same time.
- Some functions may not be supported, depending on the model.

Electric Heater (Optional)

It can only be set during heating operation.

-  is displayed on the display screen.

NOTE

- The indoor unit displays during the heating mode, the Auxiliary heater is automatically turned on, but it is not displayed on the wireless remote controller separately.
- It operates in Floor heating mode in Console products.
- Heating Mode is not available for Cooling only models.
- Some functions may not be supported, depending on the model.

Comfort Cooling (Optional)

This function is automatically control the cooling strength to maintain the pleasant feeling without turning off the product after the indoor temperature reached the desired temperature.



-  is displayed on the display screen.

NOTE

- It can be selected only during the cooling operation.
- Some functions may not be supported, depending on the model.

Timer Functions

Setting the Current Time



- 1 Press **SET/CLEAR** button for 3 seconds.
- 2 Press  or  button until the desired time is set.
 - If you press down and hold the button for a long time, the time will change more quickly in 10 minute increments.

NOTE

- Check the indicator for A.M. and P.M.



Sleep Timer Setting

- 1 Turn the appliance on.
- 2 Press **SLEEP** button to turn the timer on or off.

 3^{hr.} AM 6:00
- 3 Press  or  button until the desired time is set.
 - 7 hours is the maximum setting.
- 4 Press **SET/CLEAR** button.

Setting the On Timer



- 1 Press **ON** button to turn the timer on or off.

AM 6:00 ON
- 2 Press  or  button until the desired time is set.
- 3 Press **SET/CLEAR** button.

Setting the Off Timer

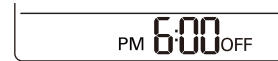
- 1 Press **OFF** button to turn the timer on or off.



- 2 Press  or  button until the desired time is set.
- 3 Press **SET/CLEAR** button.

Canceling the Timer Setting

You can cancel all timer settings.

- Press **SET/CLEAR** button.

NOTE

- If you wish to cancel a specific timer setting, press the each timer button to turn on or off the Sleep Timer, On Timer, or Off Timer as you want. Then press the **SET/CLEAR** button while aiming the remote controller at the signal receptor.
- The timer lamp on the air conditioner and the display will go off.

Forced Operation

Forced operation is used when the remote controller can't be used.

- The operation will be started if the **Forced Operation** button is pressed.

Type 1



Type 2

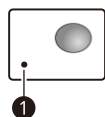

- ① Forced Operation Button

Test Operation

During the TEST OPERATION, the unit operates in cooling mode at high speed fan, regardless of room temperature, and resets after 18 minutes. During test operation, if the remote controller signal is received, the unit can be set by the remote controller. If you want to use this operation, Press and hold the ON/OFF button for 3 ~ 5 seconds, then the buzzer sound 1 will 'beep'. If you want to stop the operation, re-press the button.

Auto Restart Function

This function is useful in the case of power failure. When power regains after a failure this feature restores the previous operating condition and the air conditioner will run in the same settings.

NOTE

- This feature is enabled by the factory default settings, but you can disable it by pressing and holding the ON/OFF button for 6 seconds. The unit will beep twice and the lamp will blink 8 times.
- To enable it, press the button again for 6 seconds. The unit will beep twice and the blue lamp will blink 4 times.

MAINTENANCE

Cleaning the Air Filter

- 1 Remove the Air filters.
 - Take hold of the tab and pull slightly forward to remove the filter.
- 2 Clean dirt from the air filter using a vacuum cleaner or by washing with water.
 - If dirt is conspicuous, wash with a neutral detergent in lukewarm water.

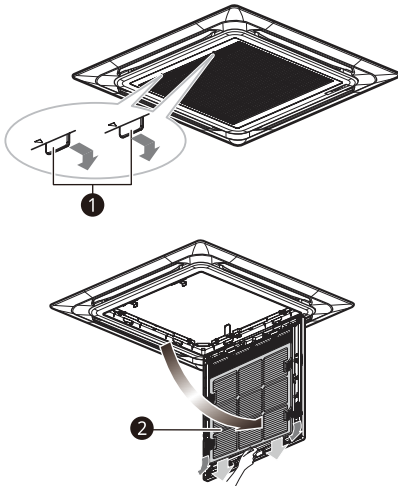

- 3 After washing with water, dry well in the shade.
- 4 Install the air filter.

- ① Rack
- ② Air Filter

CAUTION

- Before performing any maintenance, turn off the main power to the system.
- When the air filter needs to be removed, do not touch the metal parts of the indoor unit. Doing so may cause an injury.

NOTE

- Water hotter than 40 °C could cause deformation or discoloration.
- Volatile substances could damage the surfaces of the air conditioner.
- The air filters behind the front grille should be checked and cleaned once every 2 weeks or more often if necessary.
- Supply power must be disconnected before cleaning the indoor unit.
- Turn the system off before cleaning. To clean, wipe with a soft, dry cloth. Do not use bleach or abrasives.

Cleaning the Deodorization Filter/PM1.0 Filter (Optional)

- 1 Press the fixing hooks on both sides and open the front grille.

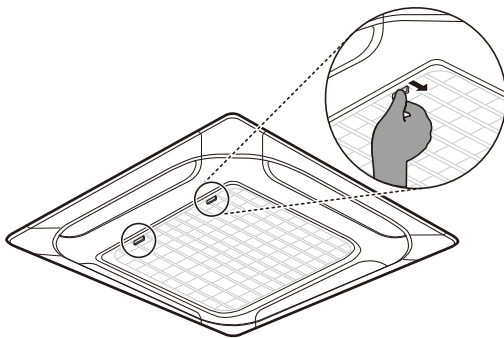

- 2 Remove PM1.0 filter by pressing the fixing hook.

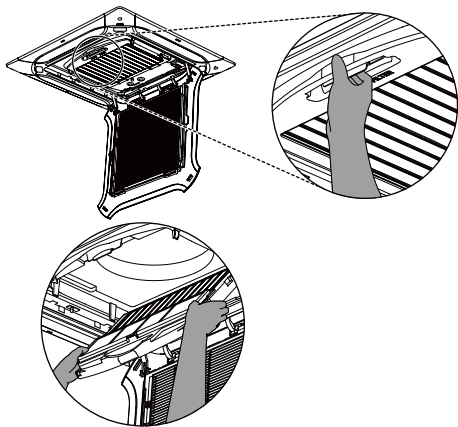

- 3 Remove the photocatalyst Deodorization filter by pulling upward.

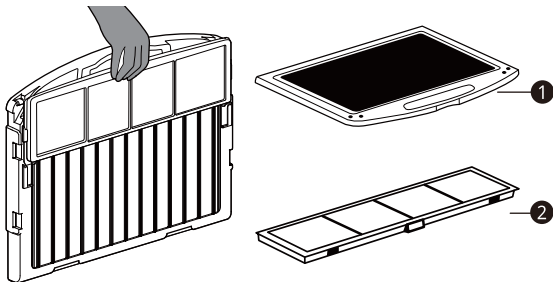

- 4 After assembling in reverse order, close the front grille.

- ① PM1.0 Filter
- ② Deodorization Filter

WARNING

- For safety, turn off the main power switch.

CAUTION

- Be careful that the filter case is correctly assembled to the filter holder.
- Be careful not to drop the front grille when removing the filter.
- Do not wash the dust filter with hot water over 40 °C or volatile liquids.
- Do not wash the photocatalytic Deodorization filter in water.
- After cleaning the PM1.0 filter, the buzzer sounds 7 times if the water is not completely dry. Dry the filter thoroughly.
- Drying the filter near a fire or in direct sunlight may cause damage to the filter.
- Wear gloves during installation.

NOTE

- The quantity and type of filters provided by each model may differ.
- The feature may be changed according to the type of model.
- Some functions may not be supported, depending on the model.

Filter Information

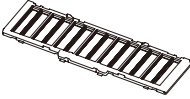
Filter Name	Filter Description
<p>Deodorization filter</p> 	<ul style="list-style-type: none"> • Dry for 3 hours in sunlight or under fluorescent light. • It is recommended to clean it every six months. (assuming 8 hours of daily use) • Washing the filter with water could damage or deform it.
<p>PM1.0 filter</p> 	<ul style="list-style-type: none"> • Clean the filter without disassembling it. • Submerge the PM1.0 filter in water, shaking it several times to clean it. • If the filter is very dirty, soak it for 30 minutes in lukewarm water with mild detergent and rinse thoroughly with clean water. (Do not use acidic detergents such as citric acid.) • It is recommended to clean it every six months. (assuming 8 hours of daily use) • Dry it thoroughly in the shade for about a day. (If there is any remaining moisture, the buzzer will sound 7 times.) Drying with a hot air heater, such as a hair dryer or a heater, could damage or deform the filter. • The inside of the filter is sharp, so do not rub or touch it directly.

Cleaning the PM1.0 Sensor (Optional)

PM1.0 Sensor

- 1 Remove the PM1.0 Sensor corner cover on the front panel.

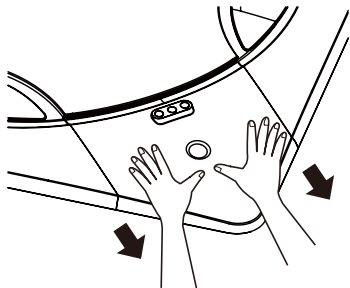

- 2 Open the PM1.0 sensor case on the side of the PM1.0 Sensor case and remove the rubber cap.

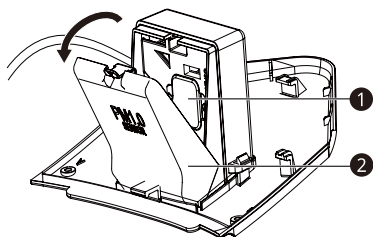

- 3 Use a cotton swab to wipe the dirt off the lens, and then use a dry swab to remove the moisture.

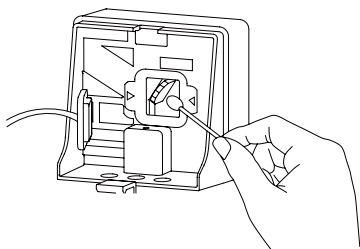

- 4 Tighten the rubber cap, close the PM1.0 sensor case, and assemble the PM1.0 Sensor corner cover to its original position.

- ① Rubber Cap
- ② PM1.0 Sensor Case

⚠ WARNING

- For safety, turn off the main power switch.
- Be careful not to drop the product when removing the PM1.0 Sensor corner cover.
- Be careful of falling accidents when cleaning the PM1.0 sensor.

NOTE

- It is recommended to clean it every six months. (assuming 8 hours of daily use)
- PM1.0 Sensor is only included with Air purification panel.
- The feature may be changed according to the type of model.
- Some functions may not be supported, depending on the model.

Tips for Maintenance

When not in Use for a Long Time

- 1 Operate the air conditioner at the following settings for 2 to 3 hours.
 - Type of operation: Fan operation mode.
 - This will dry out the internal mechanisms.
- 2 Turn off the breaker.



CAUTION

- Turn off the breaker when the air conditioner is not going to be used for a long period of time.
 - Dirt may collect and may cause a fire.

NOTE

- Dust and impurities collected in the air filter may block the air flow or reduce the unit performance.

When Use again after a Long Period of Non-Use

- 1 Clean the air filter and install it in the indoor unit.
- 2 Check that the air inlet and outlet of the indoor/outdoor unit are not blocked.
- 3 Check that the ground wire is connected correctly.
 - The ground wire may be connect to the indoor unit side.

Operation Tips

- Do not overcool the room.
 - This is not good for the health and wastes electricity.
- Keep blinds or curtains closed.
 - Do not let direct sunshine enter the room when the air conditioner is in operation.
- Keep the room temperature uniform.
 - Adjust the vertical and horizontal airflow direction to ensure a uniform temperature in the room.
- Make sure that the doors and windows are shut tight.
 - Avoid opening doors and windows as much as possible to keep the cool air in the room.
- Clean the air filter regularly.
 - Blockages in the air filter reduce the airflow and lower cooling and dehumidifying effects. Clean at least once every two weeks.
- Ventilate the room occasionally.
 - Since windows are kept closed, it is a good idea to open them and ventilate the room now and then.

TROUBLESHOOTING

Before Calling for Service

Check the following before calling for service. If the problem persists, contact an LG Electronics service center(centre) or your dealer.

Symptoms	Possible Cause & Solution
The air conditioner does not operate.	Have you made a mistake in setting the timer?
	Has the fuse blown or has the circuit breaker been tripped?
The room has a peculiar odor.	Check that this is not a damp smell exuded by the walls, carpet, furniture or cloth items in the room.
It seems that condensation is leaking from the air conditioner.	Condensation occurs when the airflow from the air conditioner cools the warm room air.
Air conditioner does not operate for about 3 minutes after restarting.	This is a protective mechanism.
	Wait about three minutes and operation will begin.
Does not cool or heat effectively.	Is the air filter dirty? See air filter cleaning instructions.
	The room may have been very hot when the room air conditioner was first turned on. Allow time for it to cool down.
	Has the temperature settings been set incorrectly?
	Are the indoor unit's air inlet or outlet vents obstructed?
The air conditioner operation is noisy.	For a noise that sounds like water flowing. <ul style="list-style-type: none"> This is the sound of freon flowing inside the air conditioner unit.
	For a noise that sounds like the compressed air releasing into the atmosphere. <ul style="list-style-type: none"> This is the sound of the dehumidified water being processed inside the air conditioning unit.
A cracking sound is heard.	This sound is generated by the expansion/contraction of the inlet grille, etc. due to changes in temperature.
Remote control display is faint, or no display at all.	Has the circuit breaker been tripped?
	Are the batteries inserted in the opposite (+) and (-) directions?

Call for service immediately in the following situations

- The occurrence of anything abnormal such as a burning smell, loud noise, etc. Stop the unit and turn the breaker off. Never try to repair the unit by yourself or restart the system in such cases.
- Main power cord is too hot or damaged.
- Error code is generated by self diagnosis.
- Water leaks from the indoor unit even though the humidity is low.
- Any switch, breaker (safety, earth) or fuse fails to work properly.

NOTE

- The user must carry routine checkups & cleaning to avoid poor performance by the unit. In case of special situations, the job must be carried out by service person only.

LIMITED WARRANTY (USA)

The product's full Limited Warranty terms and conditions and arbitration requirements are available at <https://www.lghvac.com>

LIMITED WARRANTY (CANADA)

THE PRODUCT'S FULL LIMITED WARRANTY TERMS AND CONDITIONS ARE AVAILABLE AT [HTTPS://WWW.LGHVAC.COM](https://www.lghvac.com)

ARBITRATION NOTICE: THIS LIMITED WARRANTY CONTAINS AN ARBITRATION PROVISION THAT REQUIRES YOU AND LG TO RESOLVE DISPUTES BY BINDING ARBITRATION INSTEAD OF IN COURT, UNLESS THE LAWS OF YOUR PROVINCE OR TERRITORY DO NOT PERMIT THAT, OR, IN OTHER JURISDICTIONS, IF YOU CHOOSE TO OPT OUT. FOR FURTHER CLARITY, THIS ARBITRATION PROVISION IS NOT APPLICABLE TO CONSUMERS RESIDING IN ONTARIO AND QUÉBEC. IN ARBITRATION, CLASS ACTIONS AND JURY TRIALS ARE NOT PERMITTED. PLEASE SEE THE SECTION TITLED "PROCEDURE FOR RESOLVING DISPUTES" BELOW.

DISCLAIMER: IF YOU ARE A CONSUMER SUBJECT TO QUÉBEC AND ONTARIO'S CONSUMER PROTECTION ACT, THE EXCLUSION OF WARRANTIES CONTAINED IN THIS SECTION DO NOT EXCLUDE OR LIMIT THE RIGHTS AND REMEDIES THAT YOU MAY HAVE UNDER SUCH ACT, INCLUDING THE RIGHT TO MAKE A CLAIM UNDER ANY OF THE STATUTORY WARRANTIES PROVIDED THEREUNDER.

PROCEDURE FOR RESOLVING DISPUTES:

EXCEPT WHERE PROHIBITED AT LAW (INCLUDING WITH RESPECT TO QUÉBEC AND ONTARIO CONSUMERS), ALL DISPUTES BETWEEN YOU AND LG ARISING OUT OF OR RELATING IN ANY WAY TO THIS LIMITED WARRANTY OR THE PRODUCT SHALL BE RESOLVED EXCLUSIVELY THROUGH BINDING ARBITRATION, AND NOT IN A COURT OF GENERAL JURISDICTION. EXCEPT WHERE PROHIBITED AT LAW (INCLUDING WITH RESPECT TO QUÉBEC AND ONTARIO CONSUMERS), YOU AND LG BOTH IRREVOCABLY AGREE TO WAIVE THE RIGHT TO A JURY TRIAL AND TO BRING OR PARTICIPATE IN A CLASS ACTION.

Definitions. For the purposes of this section, references to "LG" mean LG Electronics Canada, Inc., its parents, subsidiaries and affiliates, and each of their officers, directors, employees, agents, beneficiaries, predecessors in interest, successors, assigns and suppliers; references to "dispute" or "claim" shall include any dispute, claim or controversy of any kind whatsoever (whether based in contract, tort, statute, regulation, ordinance, fraud, misrepresentation or any other legal or equitable theory) arising out of or relating in any way to the sale, condition or performance of the product or this Limited Warranty.

Notice of Dispute. In the event you intend to commence an arbitration proceeding, you must first notify LG in writing at least 30 days in advance of initiating the arbitration by sending a letter to LGECI Legal Team at 20 Norelco Drive, North York, Ontario, Canada M9L 2X6 (the "Notice of Dispute"). You and LG agree to engage in good faith discussions in an attempt to amicably resolve your claim. The notice must provide your name, address, and telephone number; identify the product that is the subject of the claim; and describe the nature of the claim and the relief being sought. If you and LG are unable to resolve the dispute within 30 days of LG's receipt of the Notice of Dispute, the dispute shall be resolved by binding arbitration in accordance with the procedure set out herein. You and LG both agree that, during the arbitration proceeding, the terms (including any amount) of any settlement offer made by either you or LG will not be disclosed to the arbitrator until the arbitrator determines the dispute.

Agreement to Binding Arbitration and Class Action Waiver. Upon failure to resolve the dispute during the 30 day period after LG's receipt of the Notice of Dispute, you and LG agree to resolve any claims between you and LG only by binding arbitration on an individual basis, unless you opt out as provided below, or you reside in a jurisdiction that prevents full application of this clause in the circumstances of the claims at issue (in which case if you are a consumer, this clause will only apply if you expressly agree to the arbitration). To the extent permitted by applicable law, any dispute between you and LG shall not be combined or consolidated with a dispute involving any other person's or entity's product or claim. More specifically, without limitation of the foregoing, except to the extent such a prohibition is not permitted at law, any dispute between you and LG shall not under any circumstances proceed as part of a class or representative action. Instead of arbitration, either party may bring an individual action in small claims court, but that small claims court action may not be brought on a class or representative basis except to the extent this prohibition is not permitted at law in your province or territory of jurisdiction as it relates to the claims at issue between you and LG. This does not apply to consumers in Ontario and Québec. In accordance with provincial legislation, the consumer and LG may agree to resolve the dispute using any procedure available, including commencing the action before the competent courts of those provinces.

Arbitration Rules and Procedures. To begin arbitration of a claim, either you or LG must make a written demand for arbitration. The arbitration will be private and confidential, and conducted on a simplified and

expedited basis before a single arbitrator chosen by the parties under the provincial or territorial commercial arbitration law and rules of the province or territory of your residence. You must also send a copy of your written demand to LG at LG Electronics, Canada, Inc., Attn: Legal Department- Arbitration, 20 Norelco Drive, North York, Ontario M9L 2X6. This arbitration provision is governed by your applicable provincial or territorial commercial arbitration legislation. For consumers in Ontario and Québec, the applicable arbitration legislation only applies if consumers agree to submit the dispute to arbitration. Judgment may be entered on the arbitrator's award in any court of competent jurisdiction. All issues are for the arbitrator to decide, except that, issues relating to the scope and enforceability of the arbitration provision and to the arbitrability of the dispute are for the court to decide. The arbitrator is bound by the terms of this provision.

Governing Law. The law of the province or territory of your purchase shall govern this Limited Warranty and any disputes between you and LG except to the extent that such law is preempted by or inconsistent with applicable federal or provincial/territorial law. Should arbitration not be permitted for any claim, action, dispute or controversy between you and LG, you and LG attorn to the exclusive jurisdiction of the courts of the province or territory of your purchase for the resolution of the claim, action, dispute or controversy between you and LG.

Fees/Costs. You do not need to pay any fee to begin an arbitration. Upon receipt of your written demand for arbitration, LG will promptly pay all arbitration filing fees unless you seek more than \$25,000 in damages, in which case the payment of these fees will be governed by the applicable arbitration rules. Except as otherwise provided for herein, LG will pay all filing, administration and arbitrator fees for any arbitration initiated in accordance with the applicable arbitration rules and this arbitration provision. If you prevail in the arbitration, LG will pay your attorneys' fees and expenses as long as they are reasonable, by considering factors including, but not limited to, the purchase amount and claim amount. Notwithstanding the foregoing, if applicable law allows for an award of reasonable attorneys' fees and expenses, an arbitrator can award them to the same extent that a court would. If the arbitrator finds either the substance of your claim or the relief sought in the demand is frivolous or brought for an improper purpose (as measured by the applicable laws), then the payment of all arbitration fees will be governed by the applicable arbitration rules. In such a situation, you agree to reimburse LG for all monies previously disbursed by it that are otherwise your obligation to pay under the applicable arbitration rules. Except as otherwise provided for, LG waives any rights it may have to seek attorneys' fees and expenses from you if LG prevails in the arbitration.

Hearings and Location. If your claim is for \$25,000 or less, you may choose to have the arbitration conducted solely (1) on the basis of documents submitted to the arbitrator, (2) through a telephonic hearing, or (3) by an in-person hearing as established by the applicable arbitration rules. If your claim exceeds \$25,000, the right to a hearing will be determined by the applicable arbitration rules. Any in-person arbitration hearings will be held at the nearest, most mutually-convenient arbitration location available within the province or territory in which you reside unless you and LG both agree to another location or agree to a telephonic arbitration.

Severability and Waiver. If any portion of this Limited Warranty (including these arbitration procedures) is unenforceable, the remaining provisions will continue in full force and effect to the maximum extent permitted by applicable law. Should LG fail to enforce strict performance of any provision of this Limited Warranty (including these arbitration procedures), it does not mean that LG intends to waive or has waived any provision or part of this Limited Warranty.

Opt Out. The arbitration provision requires you and LG to resolve disputes by binding arbitration instead of court, unless the laws of your province or territory do not permit that, or, in other jurisdictions, if you choose to opt out. The arbitration provision does not apply to consumers in Ontario and Québec.

For individuals that fall within the binding arbitration provisions, you may opt out of this dispute resolution procedure. If you opt out, neither you nor LG can require the other to participate in an arbitration proceeding. To opt out, you must send notice to LG no later than 30 calendar days from the date of the first consumer purchaser's purchase of the product by either (i) sending an e-mail to optout@lge.com, with the subject line: "Arbitration Opt Out;" or (ii) calling 1-800-980-2973. You must include in the opt out e-mail or provide by telephone: (a) your name and address; (b) the date on which the product was purchased; (c) the product model name or model number; and (d) the serial number (the serial number can be found (i) on the product; or (ii) online by accessing https://www.lg.com/ca_en/findmodel_serial/).

In the event that you "Opt Out", the law of the province or territory of your residence shall govern this Limited Warranty and any disputes between you and LG except to the extent that such law is preempted by or inconsistent with applicable federal or provincial/territorial law. Should arbitration not be permitted for any claim, action, dispute or controversy between you and LG, you and LG agree to attorn to the exclusive jurisdiction of the courts of the province or territory of your residence for the resolution of the claim, action, dispute or controversy between you and LG.

You may only opt out of the dispute resolution procedure in the manner described above (that is, by e-mail or

telephone); no other form of notice will be effective to opt out of this dispute resolution procedure. Opting out of this dispute resolution procedure will not affect the coverage of the Limited Warranty in any way, and you will continue to enjoy the full benefits of the Limited Warranty. If you keep this product and do not opt out, then you accept all terms and conditions of the arbitration provision described above.

Conflict of Terms. In the event of a conflict or inconsistency between the terms of this Limited Warranty and the End User License Agreement (“EULA”) in regards to dispute resolution, the terms of this Limited Warranty shall control and govern the rights and obligations of the parties and shall take precedence over the EULA.



US	Please call the installing contractor of your product, as warranty service will be provided by them.
CANADA	Service call Number # : (888) LG Canada, (888) 542-2623 Numéro pour les appels de service : LG Canada, 1-888-542-2623