

INSTRUCTION MANUAL

FRONT LOAD WASHER

Before using the product, make sure to read the 'SAFETY PRECAUTIONS', so that you can use it correctly.

Keep this manual in a place where a user can easily access it at any time.

Product warranty is included in this manual.

The product is for washing at **household**, so we do not recommend use for **commercial, testing, or industrial** purposes.



For more details on how to use, visit LG Electronics website or use your smart device.

TABLE OF CONTENTS

This manual is prepared for various types of models. So, it may contain some images or contents that does not match your product.

The main method for using this product can be also found in printing material provided separately.

This manual is subject to changes depending on the circumstance of LG Electronics.

SAFETY PRECAUTIONS04

INSTALLATION.....13

Part Names.....	13
Accessories	14
Selecting an Installation Location.....	15
Removing the Fixing Bolts.....	15
Installing Conduction Prevention Brackets (Commencer).....	16
Leveling	16
Installing the Slipping Prevention Seats	17
Connecting Water Supply Hoses.....	18
Installing the Water Drain Hoses	21
Things to Know for Grounding.....	22

USING THE WASHER23

Things to Know before Using the Washer	23
Handling Laundry	24
Using Detergents or Fabric Softeners	25
Washing.....	26
Washing Cycles.....	27
Option Functions	28
Using Washing Cycles.....	29
Using the Optional Functions	38

CLEANING.....45

Cleaning the Detergent Box	45
Cleaning the Washing Bucket	45
Cleaning the Water Circulation Filters	46
Cleaning the Rubber Packing.....	46
Cleaning the Water Supply Inlet Net	47
Cleaning the Discharge Pump Net.....	47

Smart function49

Using the Tag On Function	49
Using the Wi-Fi Function	50
Registering the Product and Setting Wi-Fi	50
Smart diagnosis.....	52

SEPARATELY SOLD ACCESSORIES FOR INSTALLATION.....	53
THINGS TO CHECK BEFORE REPORTING PROBLEMS	54
Troubleshooting.....	57
PRODUCT ENERGY EFFICIENCY CLASS DISPLAYS	60
PRODUCT WARRANTY	60
STANDARDS FOR RESOLVING CONSUMERS DISPUTES.....	61
REGARDING THE CONSUMER SERVICE.....	62
Consumer's rights.....	62
Responsibilities for Charged Service (Paid By Customers)	62
PROCEDURE FOR DISPOSING ELECTRONICS WASTES	63
If You Purchased a New Product.....	63
Simple Disposal.....	63

SAFETY PRECAUTIONS

The following safety marks are used to prevent unexpected danger or damages ahead of time by using the product safely and correctly.

The safety precautions are classified into 'warnings' and 'cautions' and they have the following implications.

 The symbol is used to call your attention for items and manipulations that can cause danger. When you see this symbol, you need to carefully read it and follow instructions to avoid danger.

 **WARNING** - If you violate this instruction, it may cause severe injury or death.

 **CAUTION** - If you violate this instruction, it may cause slight injury or product damages.

This device complies with household (class B) EMIF standards. It is mainly intended for use at household and it can be used in all areas.

Recommended period of safe usage: five years

If the recommended period of safe usage is exceeded then an accident can occur due to the environment of use or product aging. You are recommended to receive safety check within the recommended period of safe usage (It is a charged service).

WARNING

Installation Related

Do not install the product near the source of heat or place a candle fire, cigarette fire or mosquito coil on top of it.

- A fire or product deformation may occur.



Do not install the product in a place exposed to water bubbles or rain/wind such as a bathtub.

- A fire or electric shock may occur.
- Frozen hose below zero in the winter can cause water leaks.



Install the product where you can easily remove the power plug. When you clean it or do not use the product for a long time, make sure to remove the power plug.

- A fire or electric shock may occur.

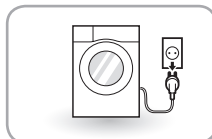

Fix the drain hose securely.

- Water may splash, causing electric shock.

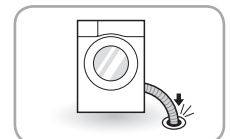

When moving or installing the product in a different location, have a service engineer from an LG Electronics service center install and check the product.

- Installing the product incorrectly may cause a fire or product failure.



Do not install the product by firmly pressing it to the wall.

- Damaged power plug or power cable can cause fire or electrical shocks.

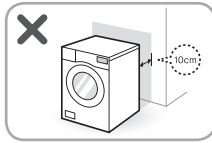

In case of commencing washer, to prevent conduction, refer to 'Installing Conduction Prevention Brackets' and make sure to install a conduction prevention bracket.

- It can cause production conduction or injury.

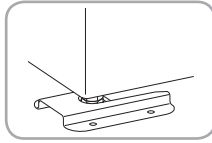

Power Related

The product is only for 220 V. For your safety, before inserting the power plug into the consent, make sure to ground it or connect it to a circuit breaker.

- Product malfunction or electrical leaks can cause electrical shocks.

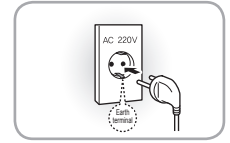

Do not modify the power cord on your own.

- A fire or electric shock may occur.

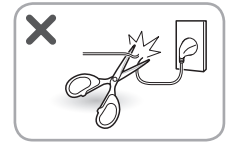

Connect the power plug in a way that the power cord is faced downward.

- If you connect it in the opposite direction, a cut in the power cord can cause fire or electrical shocks.

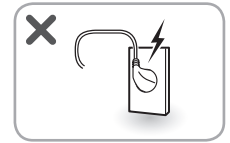

Use the power outlet only for the product, and do not use one outlet for several products.

- A fire or electric shock may occur.

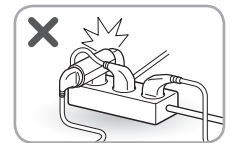

Do not use an extended consent but use an exclusive consent for your washer when you connect to power.

- A fire or electric shock may occur.

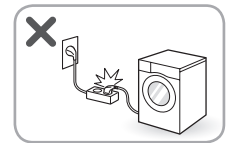

Do not let the power cord pressed or cut by a heavy object.

- A fire or electric shock may occur.

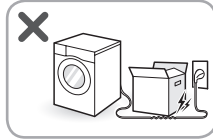

Unplug by firmly grasping the plug, not the wire.

- If you pull the power cord, the core wire may break, causing a fire or electric shock.

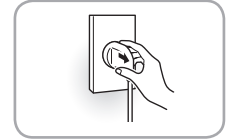

When the power cord or plug is damaged, or the power consent hole is loose, then stop using the product and call the LG Electronics service center immediately.

- A bad contact can cause electrical shocks, electrical leaks or fire.

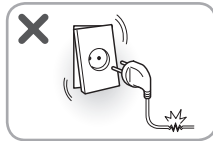

Manage the surrounding environments not to create the remains of pets, rats or insects (cockroach, fly, bedbug etc) inside the product.

- The power cord may be damaged or a fire may occur.



Prevent small animals or pets from chewing the power cord or water supply hose.

- The animal may get a shock or product or property damage may occur.

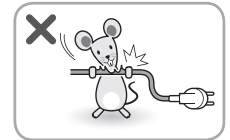

If the power plug is dusty or wet, wipe with a dry towel.

- A fire or electric shock may occur.

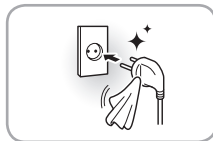

Use Related

Insert the power plug into the end firmly.

- A fire or electric shock may occur.

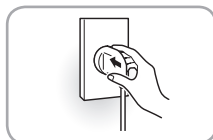

When cleaning, do not spray water on the product directly.

- A fire or electric shock may occur.



Do not touch the power plug with wet hands.

- An electric shock may occur.



Do not press the button with a sharp object such as an awl or pin.

- An electric shock may occur.



Do not disassemble, repair or alter the product unless it is conducted by a service engineer of LG Electronics service center.

- An electric shock, fire or malfunctions may occur.

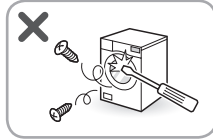

Do not use solvent-based detergent.

- Toxic gas, damage to product parts, fire, or explosion may occur.

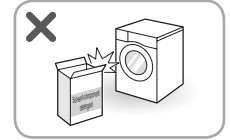

When gas is leaking, do not operate the product or power cable. Open the window and ventilate the indoors.

- Sparks may cause explosion or fire.

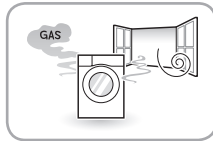

Do not use flammable gas or combustible material (benzene, gasoline, thinner, petroleum or alcohol) near the product.

- An explosion or fire may occur.



Do not let your child or pet go into the washer.

- It can cause suffocation or drowning.

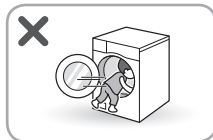

During the high-temp washing, boiling or drying process, the washer's door glass or top gets very hot. So, do not touch them.

- It can cause fire burns or injury.



Do not let your child approach the product when it is running.

- An injury may occur.

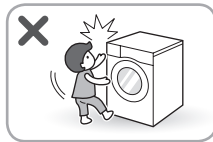

If the product bottom is soaked in water, do not go into the washing room.

- A fire or electric shock may occur.

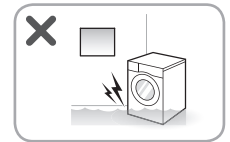

Do not let your child or pet go on top of the product.

- Falling can cause injury.

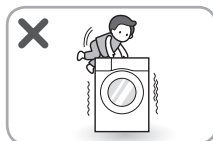

If the product has been submerged, contact LG Electronics service center for procedure.

- A fire or electric shock may occur.

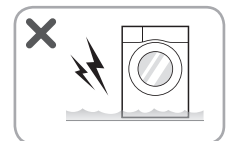

Do not let your child or pet hang on to the washer door.

- Falling can cause injury or make the product flipped over.

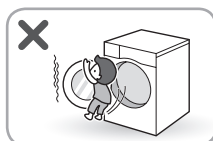

Do not insert laundry materials touched by flammable gas or combustible material (benzene, gasoline, thinner, animal oil, vegetable oil, dry cleaning agent) into the washer.

- It can start chemical reactions, causing fire or explosions.



If you detect a strange sound, smell or smoke from the product, unplug it immediately, contact an LG Electronics service center and follow their instructions.

- A fire or electric shock may occur.



If the drain hose and the water supply hose are frozen in winter, defrost before using.

- It can cause fire or electrical shocks. A part may be frozen so that the product may not operate or the product's life may be reduced.



Disposal Related

Properly dispose the packing material (vinyl, styrofoam) out of the reach of your children.

- Packing material can cause suffocation.



When discarding the product, sever the power plug and destroy the button unit of the product.

- Reusing the discarded product may cause a fire or electric shock.



When disposing the product, first damage the locking device for the door.

- If a child is locked inside the washer, it can cause suffocation.

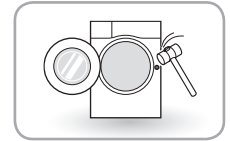

⚠ CAUTION

Installation Related

When installing or moving the product, a group of at least two persons should be involved for the safety purposes.

- If the product falls, or you get hit by the product, it can cause injury.



Install the product on a firm and horizontal floor.

- A vibration or noise may occur.

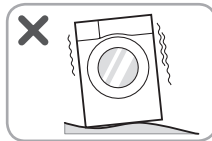

Do not install the product inside a camping car, ship or airplane.

- When you want to know if you can use the product in a specific condition, contact your nearby LG Electronics service center.



Make sure that the cold water inlet and the hot water inlet are not switched.

- If they are switched, it can cause injury and product malfunctions.

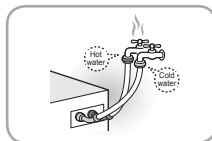

Use Related

Do not insert a live animal such as your pet into the product.

- An injury may occur.



When the steam spray is ejecting steam, do not let your body part such as hands, or feet touch it.

- Hot steam can cause burn injury.

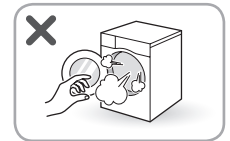

Keep hands and feet or metal objects out from under the product.

- An injury may occur.

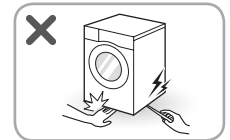

Do not let your hands get stuck when opening and closing components including the washer door, detergent box, and the sliding detergent box.

- An injury may occur.

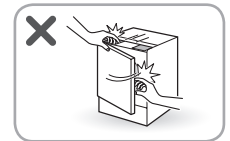
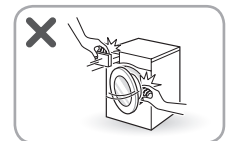

Do not open the washer door when it is operating.

- Opening the door forcibly may cause body injury or damage the product.



Do not place an object on top of the product.

- The object may fall down while operating, causing an injury.



During the boiling washing, steam, wrinkle removal or drying process, the washer's door glass top gets very hot. So, do not place object on it.

- It can cause material deterioration or deformation.



Draining water may be hot.

- Touching it may cause burns.



Use the product only for the washing purpose.

- If you use the product to wash shoes or to dry foods, then abnormal vibration can cause injury or damages to the product, wall or floor.

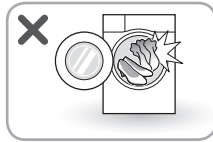

When you wash functional garments such as waterproofing textile, you must use the functional garment cycle (ski wear, rain coat, sweat jumper, gore tex, fishing vest, diaper cover, curtains, bicycle cover, automobile cover, mattress cover, mattress pad or sleeping bag).

- If you use the general washing cycle, then abnormal vibration can cause injury or damages to the product, wall, floor or clothes.



If you need to open the washer door in emergency, check whether there is water in the washer and drain it properly. Open the door only when you use the cold water.

- Touching it may cause burns.

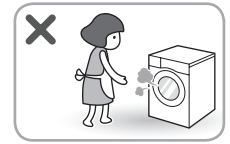

Do not hang the drain hose over the basin.

- If the washer drains more water than how much your basin can drain, then it can cause water leakages.

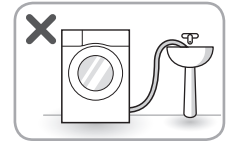

Do not wash dishes stained with chemical products such as oil, cream or lotions used in a massage parlor, skin care shop, beauty shop or barber shop.

- A part may be deformed, causing a water leak.

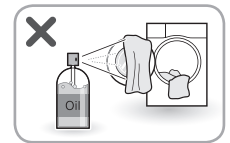

Do not wipe or coat the surface of the product with liquid detergent or bleach (chlorine bleach, oxygen bleach, etc).

- If the surface of the product is stained with bleach, coating may be corroded or discoloration may occur.

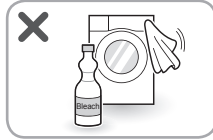

Do not directly apply detergent or whitener to the laundry.

- It can cause laundry decolorization.



After cleaning, turn off the faucet. Turn on the faucet again and check the connection status of water supply hose before cleaning.

- If the water supply hose's screws are loose, it can cause water leakages.

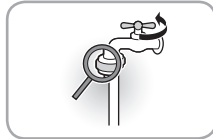

When turning on the faucet again, first press the 전원 button and the 동작/일시정지 button and turn the faucet on slowly.

- Air may be trapped in the water supply hose and the water supply pipe, causing damage to the main unit or leakage.

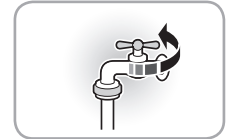

During the high-temp washing, drying or boiling cycles, check if the laundry materials is suitable for high-temperature (cotton, diaper).

- It can cause laundry to shrink or deform.

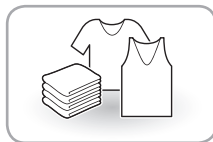

Check if the type of laundry can be washed in that specific process.

- It can cause damages to the product or laundry.



Do not wash white or bright color laundry with dark color laundry that can discharge colors.

- It can cause laundry discoloration.

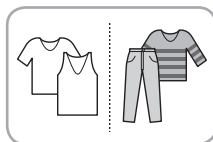

Use a detergent or whitener exclusively for washing.

- If not, It can cause damages to the product or laundry.

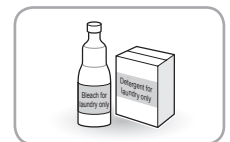

Once the detergent box is removed, do not operate the washer.

- It can cause water leakages.

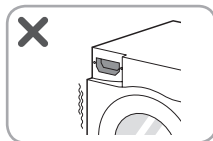

When repairing the product, replace parts with LG genuine parts only.

- Using a part which is not an LG genuine part may lower the product performance and shorten the life of the product.

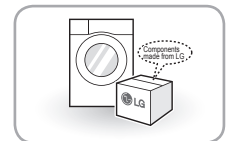

Do not use a whitener containing sulfur compounds.

- It can cause part corrosions.



Remove contents from cushions, pillows or sitting mats and only wash the cover.

- It can cause damages to the product, wall, floor or laundry. Abnormal vibration can cause injury.

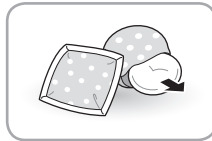

If the product is delivered during winter or at a temperature below zero, do not operate the product immediately after installing.

- If a part is frozen, it may not operate properly, causing product or part failure.

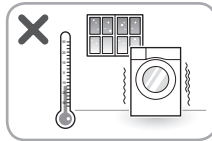

After connecting the water supply hose, turn on the faucet and check for water leaks before operating.

- If water leaks, it may cause property loss.



After the washer is delivered, remove the fixing bolt in the back before use.

- It can cause product malfunctions or noises.

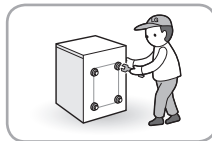

INSTALLATION

Part Names

Each model of washer may look different.

Control panel, detachable washer door

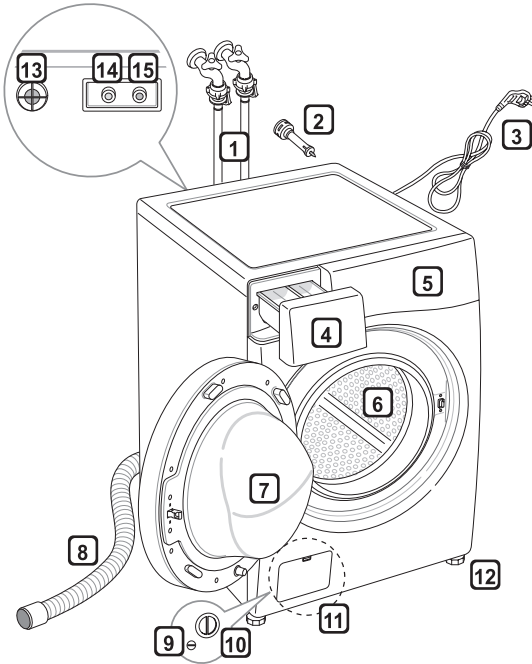

- 1 Water supply hose
- 2 Fixing bolt
- 3 Power plug
- 4 Detergent box
- 5 Function controller unit
- 6 Washing bucket
- 7 Washer door
- 8 Drain hose
- 9 Residual water remover
- 10 Discharge pump net
- 11 Service cover
- 12 Leveling foot

Control panel, integrated washer door

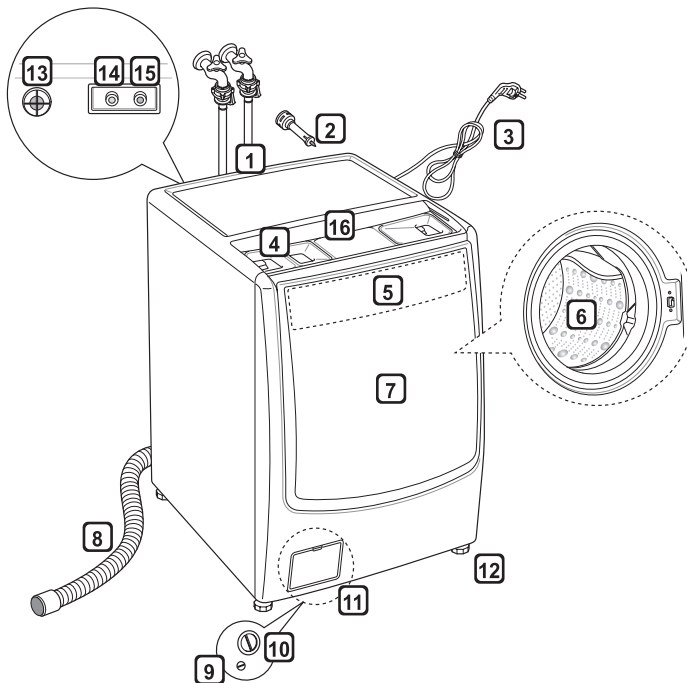

- 13 Vent
- 14 Cold water supply inlet
- 15 Hot water supply inlet
- 16 Sliding detergent box door

Accessories

- Different parts may apply to each model.

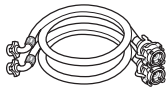

2 water supply hoses
(Cold water-blue, hot water-orange)



2 slipping prevention seats



Fixing bolts blocking plugs



Water supply hose connector



Spanner

Necessary Accessories for Additional Installation of Front Load Washer

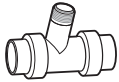

Water drain hose connector

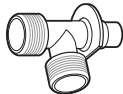

Water supply hose connector

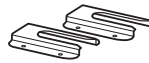

2 conduction prevention brackets

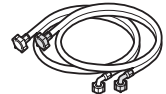

2 water supply hoses
(Cold water-blue, hot water-orange)

Selecting an Installation Location

Selection a location to install your washer.

- Install it on a firm and flat ground. If not, it can cause vibrations and noises.
- Make sure that the product is at least 10 cm away from the rear wall and 2 cm away from the side wall. The product front should be cleared for door opening.

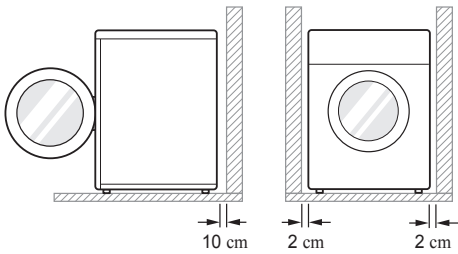

NOTE

- If you intend to install the mini wash or the drawer at the bottom of the product, refer to the following figure for installation.

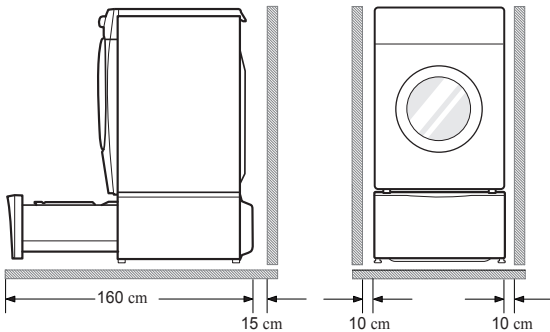

Removing the Fixing Bolts

Using a spanner, remove the four fixing bolts in the product rear and block the holes with caps.

- If you need to move the product again, then to protect the product, you should use the fixing bolts again. So, keep them in a safe place.

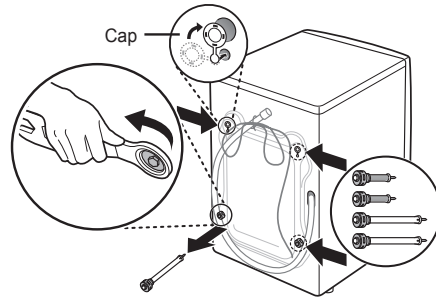

NOTE

- After removing the fixing bolts in the product rear, you need to level the product. If not, severe noises and vibration can cause malfunctions.

Installing Conduction Prevention Brackets (Commencer)

When you install the conduction prevention brackets, follow the steps in the installation manual and proceed as follows.

- 1 Refer to the installation manual and check the bracket locations.

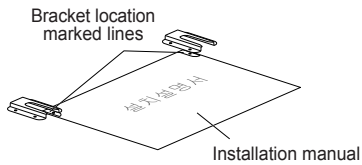

- 2 After removing the protection film from the double sided tape attached to the bracket, fix it on the ground.

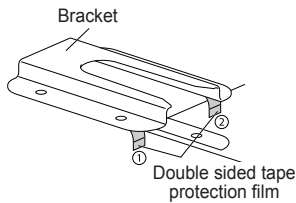

- 3 Insert the two legs of the product rear into the bracket holes.

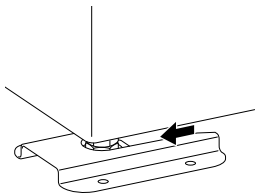

⚠ WARNING

- For a commencer washer, you have to install the conduction prevention brackets. If you don't, it can cause production conduction or injury.

Leveling

If There is no Auto Height Adjuster

- 1 First, check the gap between the four leveling legs and the floor, and use a spanner to level the product.

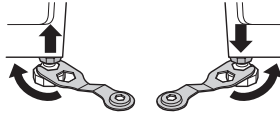

- 2 Once the leveling legs are adjusted, fix the nuts securely.

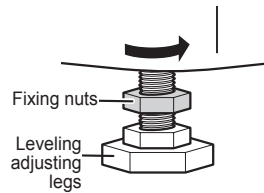

If There is an Auto Height Adjuster

Adjust the remaining leveling legs heights until the auto height adjuster in the product right rear reaches the height of 2~5 mm.

- Pay attention to make sure that the auto height adjuster is not lifted above the ground or pressed to the ground too hard.
- For height adjustment, if you release the bolts from the auto height adjusting legs, it can cause malfunctions.

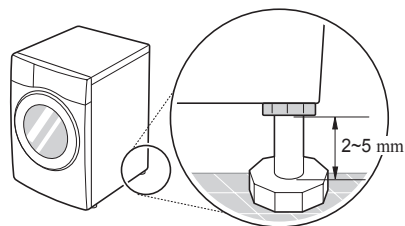

If the auto height adjuster is lifted from the ground, then release the leveling adjusting leg in the opposite diagonal until a proper height is reached.

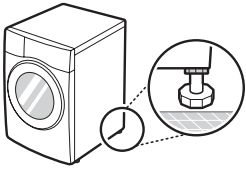

If the auto height adjuster is completely pressed to the ground, then release the two leveling adjuster legs by same steps, so that the auto height adjuster is relaxed.

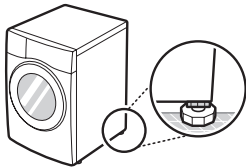

Installing the Slipping Prevention Seats

Install the slipping prevention seats on a wet floor such as in the bathroom.

- 1 Completely wipe off the installation floor.
 - Completely wipe off mold or moss from the floor.
 - If you install the slipping prevention seats without removing water, it can cause a fall-off. So, make sure to remove water.
- 2 Attach the contact surface of your slipping prevention seats to the floor.
 - For the best effects, you need to install the slipping prevention seats to the left/right legs of the product front.
 - If it is hard to do so, then attach it to the left/right legs of the product rear.

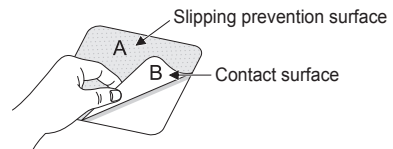

- 3 Install the product on the rough side.

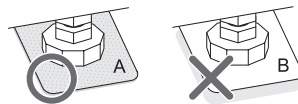

- 4 While attaching it, the leveling condition can be damaged. So, after attaching it, check if the product is leveled.

Connecting Water Supply Hoses

Separating Water Supply Hoses

Before making a connection, separate the water supply hose in the shipping condition. If not, a complete connection cannot be achieved, causing water leakages.

- 1 Turn the connector counterclockwise to separate it from the intermediate coupling device.

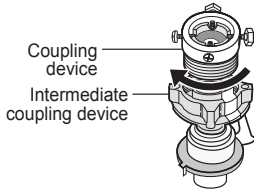

- 2 While pressing down the Press Lever and the Press Board at the same time, pull it down to separate the water supply hoses.

- If not, a complete connection cannot be achieved, causing water leakages.

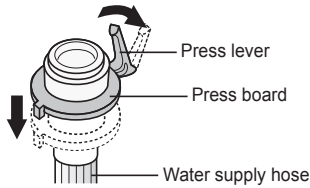

NOTE

- Connect the new water supply hose provided in the product package. An old hose can cause water leakages. Do not use it.
- If you need to extend the water supply hose by connecting it to the water supply hose connector, you need to purchase extra hoses from the LG Electronics service center.
- In case that the product installation location is changed or you move to a new house, keep your coupling device, intermediate coupling device and screw type intermediate coupling device in a safe place.
- If you have selected water temperature other than cold water, both hot and cold water will be supplied. If you just use one of hot or cold water, you must connect to the cold water supply inlet. The remaining hose can be connected to the currently used hose by using a coupling device, and the overall hose length can be extended.

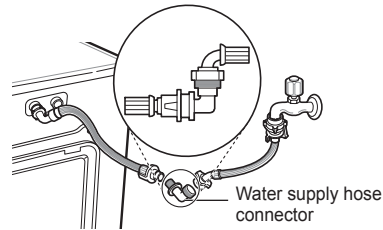

- The water pressure of 30~1000 kPa is used.

Connecting Water Supply Hose to Rounded Faucet

When installing a water supply hose, examine the shape of faucet and connect as follows.

- Adjust the fixing screw for the coupling device.
 - Adjust the four fixing screws for the coupling device to fit the size of water faucet. If the water faucet is big, then remove the guide board before making adjustments.

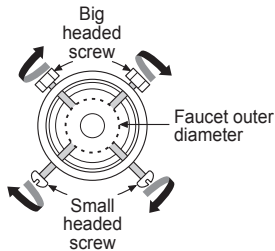

- Fix a coupling device on the faucet.
 - Make sure that the big headed screw is faced to the wall, so that the rubber packing in the coupling device is firmly pressed to the faucet.
 - After turning the big headed screws (2 units) by hands until they reach the water faucet, use a driver to firmly fix the two small headed screws.

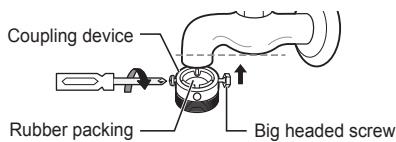

- Connect an intermediate coupling device to the connector.
 - Remove the fixing sticker and turn the intermediate coupling device clockwise until securely fixed while making sure that the screw threads are maintained. If you don't securely fix it, it can cause water leakages.

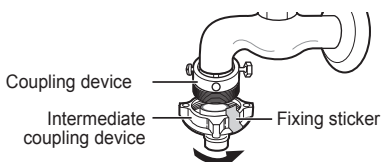

- While pressing down the Press lever and the Press board for the water supply hose at the same time, connect it to the intermediate coupling device.
 - You will hear the clicking sound when a connection is made.

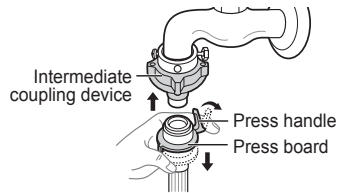

- After connecting the water supply hose to the water faucet, turn on the water faucet.
 - After connecting the water supply hose to the faucet, let the water flow to remove alien substances from the inside of the water hose. After that, turn off the water faucet again.

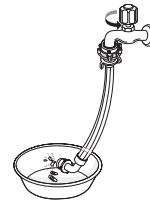

- After connecting the water supply hose to the product, turn on the water faucet.
 - Connect the cold water valve (blue) to the cold water supply inlet and the hot water valve (orange) to the hot water supply inlet.
 - If you connect it without a rubber packing, it can cause water leakages.
 - If water leaks, then start checking again from the beginning.
 - If you have only one water faucet, then connect it to the cold water supply inlet. After a connection, water supply could be stopped for about three minutes, so that the machine determines which is cold or hot water.

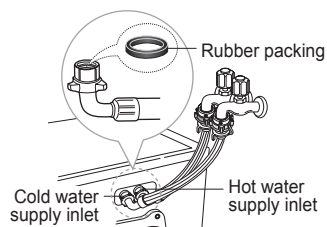

Connecting Water Supply Hoses to Screw Type Faucet with Plugs

If a screw type water supply hose is not include in the product package, then our distribution or installation staff will provide it to you for free.

- 1 Remove the nipple from the end of faucet.
 - After separating the nipple from the end of faucet, remove it properly.

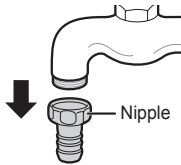

- 2 Connect a screw type intermediate coupling device to the faucet.
 - Connect a screw type intermediate coupling device in such a way that the screw threads are maintained. If not securely fastened, it can cause water leakages.
 - For further steps, refer to steps 4 through 6 in Connecting Water Supply Hoses to Rounded Faucet.

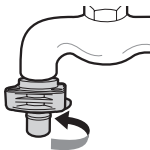

Connecting Water Supply Hoses to Screw Type Faucet without Plugs

Nipple type

Remove the nipple from the tip of faucet.

- For further steps, refer to 2 to 6 in 'Connecting Water Supply Hose to Rounded Faucet'.

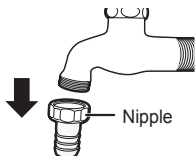

Screw Type

Remove the guide board from the inside of the connector.

- For further steps, refer to 2 to 6 in 'Connecting Water Supply Hose to Rounded Faucet'.

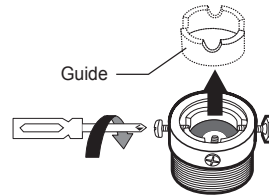

Connecting Water Supply Hoses to Two Washer

In case that you need to install an additional washer, you can use necessary accessories as shown below to connect water supply hoses to two washers.

- 1 Separate the water supply hose of the existing washer by disconnecting it from the water faucet.
 - For more details, refer to 'Separating Water Supply Hoses'.

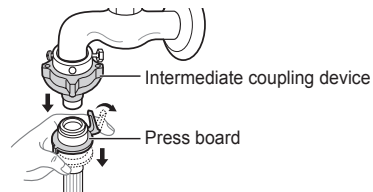

- 2 Connect the water supply hose connector to the water supply hose.
 - For more details, refer to 'Connecting Water Supply Hoses'.

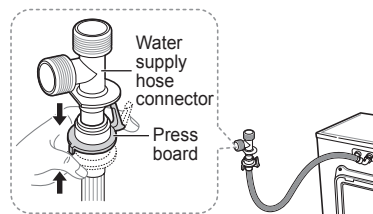

3 Open the accessory package for additional washer installation and find the water supply hose and connect it to an additional washer to be installed.

- For more details, refer to 'Connecting Water Supply Hoses'.

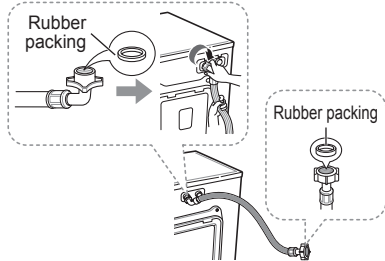

4 Connect the water supply hose provided to the faucet.

- For more details, refer to 'Connecting Water Supply Hoses'.

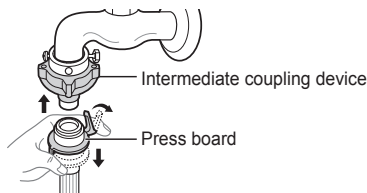

5 Connect the water supply hose connected to an additional washer to be installed and the water supply hose connected to the faucet to the intermediate coupling device.

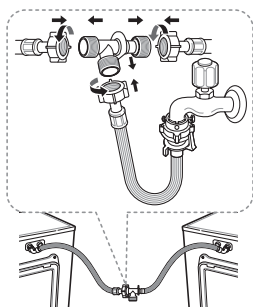

Installing the Water Drain Hoses

- Install the water drain hose on firm and flat ground by smoothly lowering it. The height of the water drain hose should not be higher than 50 cm from the ground.
- In case of some models, you need to push the drain hose into the end of the water drain hose hold in the rear of the product and fix it properly. After that, you need to smoothly lower it to finish installation.
- For a dryer model, install the water supply hose by pressing it to the floor. If the water supply hose is installed too high, drying may not be done.

⚠ CAUTION

- If you wrongly connect the water drain or supply hose, it can cause the following problems.
 - Noise occurrence during spin-drying
 - Water leakage at the joint of the water supply hose on the washer side
 - Water leakage at the joint of the water supply hose on the faucet side
 - Drain pump failures
- If the water drain hose installation location is too high, or bent or pressed, or if the tip is soaked in water, then drain can be interfered (For a drier model, drying can be interfered).

Connecting Water Drain Hoses to Two Washers

As shown below, connect the water drain hose to the water drain hose connector.

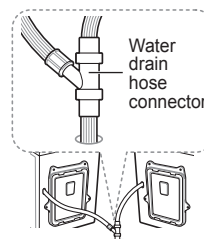

Things to Know for Grounding

- This product is only for 220 V. You must make sure to plug it into the grounded 220 V special consent.
- Do not connect other electronics to the consent that the product is connected to.
- To prevent electrical shocks caused by electricity leakages, you must first ground it before using it.

If the Consent has a Ground Terminal

- If the consent has a ground terminal, no additional grounding is required.

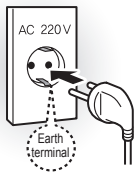

If There is No Grounding Terminal

- Check if the circuit breaker is installed, and if not, ask a special technician to install it and then use the product.

USING THE WASHER

Things to Know before Using the Washer

Use Related

- LG Electronics washer models support the capacity set forth in testing by KS. Depending on the type or volume of laundry, the nominal capacity may differ from the actual capacity.
- Do not exceed the laundry capacity. If greater than the nominal capacity, then the product performance is degraded and the product will be overloaded.
- The product performance or washing capacity is determined by the electronic control program. So, even if it uses the same type of washing bucket and motor, a different model may exhibit different performance or washing capacity.
- LG Electronics front load washer adopts the waterfall method where laundry that has absorbed water falls from the top to the bottom.
- LG Electronics front load washer uses a slight amount of water to wash laundry, so the water surface may not be visible during the washing process. But, even so, laundry is sufficiently soaked in water and being washed properly.
- If the product has the touch button type control panel and it is stained with foreign objects such as detergent, it may malfunction. Always keep the control unit clean.

Checks before Using the Washer

- Is the water supply hose correctly connected to the cold water side and the hot water side?
- Is the water faucet open?
- Is the power plug correctly inserted into the power consent?
- Is the water drain hose placed correctly?
- Is the product leveled?

Using the Washer Door

Opening the Washer Door

- Method 1: Grab and pull the handle on the right side of the washer door.
- Method 2: Press the 문열림 or 빨래추가 button. The washer door will open.

Closing the Washer Door

- Push the right center of the washer door to the end.

CAUTION

- If you do not completely insert laundry into the washing bucket (rubber packing), then the rubber packing may get damaged and it can cause water leakages.
- If the nominal washing capacity is exceeded, it can cause damages to the product or laundry.
- Do not let your hands get stuck between the washer door and the washer. It can cause injury.
- If the washer door glass is damaged, it can cause injury. So, do not operate the washer but immediately call the LG Electronics service center.
- If you forced the washer door to open, then it can cause part damages and safety problems.

NOTE

- If there is too much laundry in the machine or if you do not completely close the washer door, then door locking can fail.
- If the product is operating or 문잠김(☹) is displayed, then you cannot open the washer door. If you want to open the washer door, do not use excessive force, but press the 문열림 or 빨래추가 button or 동작/일시정지 button. Make sure the washer has completely stopped and then open the washer door after 문잠김 sign has disappeared.
- When the display unit shows **dE**, **dE1**, **dE2** or a warning sign, first close the washer door by completely pushing it. After that, press the 동작/일시정지 button.
- If a blackout occurs during operation, then you may have to wait for a while before you can open the washer door (If you use boiling-washing or if you operate a drier model, then a blackout during drying is very dangerous, so do not ever open the washer door in this case).

Usage Guideline of Sliding Detergent Box

- This contents only apply to models with the sliding detergent box.

Opening the Sliding Detergent Box

If you wish to open the sliding detergent box, open it by pushing the front part of the handle of the sliding door.

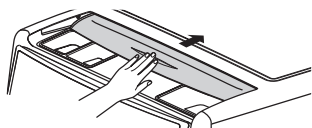

Closing the Sliding Detergent Box

If you wish to close the sliding detergent box, hold and pull the handle of the sliding door.

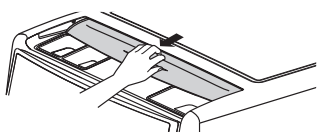

WARNING

- Do not let your hands get stuck when opening and closing the sliding detergent box or when the sliding detergent box is pushed and opened. Failure to use caution may result in injury.

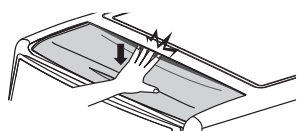
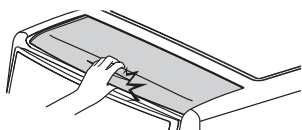
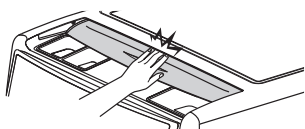

Handling Laundry

To prevent textile damages and product malfunctions, make sure to obey the following instructions.

Checking before Washing

- Check the Cautions for Handling mark attached to laundry and make sure water washing is allowed.
- Close zippers, hooks and buttons and flip them inside out before washing.
- Do not wash garments if they are stained by vegetable oil such as cold cream or massage oil.

NOTE

If you use a washer for the following types of laundry, it can cause shrinking or deformation. Check the washing label before washing them.

- Laundry containing Korean traditional clothes or textile
- Dry cleaning laundry such as shoes, leather products, neck ties, suits, and coats
- Laundry with decorations
- Laundry with artificial wrinkles
- Outer wear that contains textile or linings that shrink or decolorize when contacted by water, such as silk, wool, rayon, or acetate.
- Other types of laundry that can cause deformation or discoloration when soaked in water (refer to the washing labels)
- For further information on textile or garments that you need to pay attention when using a specific washing cycle, refer to the manual downloaded at LG Electronics website.

Removing Alien Substances

- If metallic alien substance enters the washer, it can damage laundry and break the washing bucket and generate severe noises. So, you must check each pocket of your laundry to see if it has coins, hair pins, or keys.
- Before using the washer, shake off dusts, soils or sands from your laundry as they can pollute other clean clothes.
- Before using the washer, use a special agent to remove partial stains and dusts.

Separating before Washing

- If your cloth has a long lace attached to it, nicely arrange this long lace or put it into a washing net.
- Remove contents from cushions, pillows or sitting mats and only wash the cover. Their content can stick out to damage laundry or plastic parts or generate abnormal vibrations.
- Separate colored clothes from white clothes and black clothes from clothes with lots of lint when you wash them.
- Separate blanket from general laundry. Make sure to wash it sheet by sheet. If you wash more than one sheet at a time, they can get inter-tangled with each other or stuck to one side, making the washing process to be inefficient or making spin drying very difficult.
- Do not wash electric blankets, carpets, curtains, foot cleaning seat, or rubber mats.
- Wash more than one knitting products at a time. If small laundry absorbs lots of water, then it is better to wash more than one unit at a time because washing only one unit can cause abnormal spin drying or make washing inefficient.

Using Detergents or Fabric Softeners

Using Detergents

- Use a special drum washer detergent. If you use a general type product, it can create excessive bubbles.
- Apply the recommended amount of detergent as indicated by the maker.
If you use more than a proper amount of detergent, undissolved detergent may accumulate inside the washer, causing odor.
- If a specific washing cycle requires a different amount of detergent, then refer to 'Using Washing Cycles'.
- Even if a washer model displays the amount of detergent required, then you do not need to follow it.
- For Commencer washer, refer to the below table when you add detergents.

Amount of laundry	Amount of detergent used by the commencer washer [g or ml]	
	High condensation (drum only)	Powder/liquid (drum only)
2.0 - 3.5 kg	8	13
2.0 kg or less	6	10
1.0 kg or less	5	8

- The front load washer adopts the waterfall method for washing, so it only uses 1/3 of the amount of water required by a general washer. Also, the amount of detergent required is 1/3.
- If your laundry causes less pollutions, reduce the amount of detergent. If you use too much, then excessive bubbles will remain even after rinsing.
- If the water quality is good (sweet water), then it has great washing power and creates lots of bubbles. So, reduce the amount of detergent.
- When you use liquid detergents, reduce the amount used, as it is very well dissolved in water and creates lots of bubbles.
- Natural soap powder is not very well dissolved in water, easily causing clogging. If you use it in cold water, it can cause leakages or malfunctions. Make sure to use lukewarm water.
- If you use the pre washing cycle, use less than 1/2 of the amount of detergent for the main cycle.
- If detergent exists as lumps, then grind it into powder before use.

NOTE

- Stains on inner wear (cotton) or baby clothes are mostly fats or proteins. So, instead of using lots of detergents, it is more effective to wash at high temperature and increase the number of rinsing process.
- The water supply time is short, so make sure to add detergent before washing begins.
- If the washing bucket is wet, then it is likely that some detergents still remain in it. Make sure to remove water before using the washer.
- As lint, fabric softeners, or zeolite in laundry is discharged, the high-speed rotating pump propeller can create fine bubbles that make the water look murky. Even if the drained water looks murky, it does not mean that rinsing is incomplete.
- If you use too much, then excessive bubbles will remain even after rinsing, causing an increase in the rinsing time. In addition, you will see some bubbles even after the final spin-drying process.

Using Fabric Softener

- It is automatically injected at the time of initial rinsing.
- Do not exceed the max line for fabric softener. If not, fabric softener will be directly injected into the washer.
- Before washing begins, add fabric softener into the correct location in the washing bucket. Close the detergent box by softly pushing it. If not, as fabric softener fluctuates, it can go directly into the washing bucket.

CAUTION

- Do not let fabric softener stay in the washing bucket for more than two days. As it hardens, automatic injection can fail.
- Do not use condensed fabric softener. Injection can fail.
- Do not use tissue (paper) type detergent or fabric softener. Injection hole can get clogged, causing leakages or malfunctions.
- Do not open the detergent box while water is supplied. Fabric softener injection can fail.

NOTE

- Water drained after the final rinsing process may look murky as it contains some fabric softener.
- If there is water in the fabric softener injection hole, then take out the washing bucket and remove water before injecting fabric softener.

Washing

- 1 Press the **전원** button.
 - Add laundry into the washing bucket.
 - Depending on the cycle selected, add a proper amount of detergent or fabric softener.
 - Apply the recommended amount of detergent as indicated by the maker.
 - If a specific washing cycle requires a different amount of detergent, then refer to 'Using Washing Cycles'.
- 2 Select a cycle by turning the cycle selection dial. (For more information of washing cycles, refer to 'Washing Cycles'.)
 - The default setting is automatically applied to cycle options. If you want to change it, press the option button.
- 3 Press the **동작/일시정지** button.
 - The washer door will close. The amount of laundry will be automatically detected. Water supply will start and washing begins.

If your washer indicates the amount of detergent on the display unit, proceed as follows.

- 1 Press the **전원** button.
- 2 Select a cycle by turning the cycle selection dial.
- 3 Press the **동작/일시정지** button.
 - After the washer door closes, the amount of laundry is automatically detected. The necessary amount of detergent is displayed on the window. Inject detergent and fabric softener into the injection hole and close the door. After a moment, water supply and washing will start.

NOTE

- If wet laundry is left inside the washing bucket for a long time after washing, the laundry may smell. After washing is complete, remove the laundry immediately.

Washing Cycles

You can select a proper washing cycle depending on the type of laundry and the condition of pollution. Read the following descriptions and select a proper washing cycle.

- Different cycles are available depending on the model. Make sure to check your washer model.

Washing cycle	Descriptions
표준세탁	A cycle to wash general types of laundry.
표준	
일반세탁	
란제리	A cycle to wash textile, lingerie or fine clothes that are likely to shrink or deform.
란제리/울	
울/섬세	
알뜰살음	A boiling washing cycle to sterilize and whiten cotton inner wears, or baby clothes.
표준살음	
소량살음 [3 kg]	A boiling washing cycle to sterilize and whiten clothes weighing less than 3 kg.
찌든때	A cycle to remove old stains by using the hot water of 60 °C.
찌든때(볼림)	
아기옷	A cycle to wash baby clothes hygienically.
면속옷	A simple washing cycle for cotton based inner wears.
와이셔츠	A cycle to wash old stains from the collar and cuffs of dress shirts while minimizing damages to laundry.
수건	A cycle to wash towel with hand wash marks.
이불	A cycle to wash blanket or mat with hand wash marks.
이불살균털기	A cycle to sterilize bedding such as blankets or duvets.
침구클리닝	

Washing cycle	Descriptions
스팀클리닝	A cycle to remove unpleasant odors from laundry.
에어클리닝	
알러지케어	A cycle to wash and clean by removing allergy causing agents such as pet hairs, ticks and fungus.
조용조용	A quiet mode washing cycle to reduce the level of noises for night time or when your baby sleeps.
기능성의류	A cycle to wash mountain wears, gym wears or leisure wears.
컬러케어	A cycle to wash while preserving the colors of clothes for a long time and minimizing damages to laundry.
셔츠한벌 드라이	A cycle to dry one shirt within 20 minutes after spin drying.
스피드워시	A cycle to quickly wash a small amount of laundry with little pollutions.
스피드	A cycle to quickly wash a small amount of laundry with little pollutions such as towels used frequently.
스피드워시 [3 kg]	A cycle to quickly wash a small amount of laundry with little pollutions weighing less than 3 kg.
스피드워시+ 드라이	A cycle to wash and dry a small amount of laundry such as 1 to 3 shirts within one hour.
찬물세탁	An energy saving cycle for laundry with relatively less pollutions.
소량 세탁	A cycle to wash a small amount of laundry quickly using 터보샷, 6모션 and 스팀.
스킨 케어	A cycle to increase the number of rinsing cycles to prevent some detergent from being left on laundry and protect sensitive skin.

Washing cycle	Descriptions
장마철 세탁	A cycle to wash and dry laundry all at once to prevent laundry from being damp.
땀얼룩 제거	A cycle to remove sweat stains from laundry.
한벌 세탁	A cycle to wash slightly stained clothing in the least amount of time.
키즈옷	A cycle to wash stains from children's clothing using hot water.
교복	A cycle to minimize damages to clothes that need to be washed frequently.
정전기 제거	A cycle to reduce the occurrence of static in clothing using with micro steam and hot wind.
다운로드코스	A cycle to use the cycle download function by downloading the LG Smart Washer app.
매일코스 (카테고리)	You can press the 매일코스 button to select a desired washing cycle.
위생코스 (카테고리)	You can press the 위생코스 button to select a desired washing cycle.
맞춤코스 (카테고리)	You can press the 맞춤코스 button to select a desired washing cycle.
헹굼+탈수	A cycle to cover rinsing to spin drying without washing laundry.
안심헹굼	
탈수	A cycle for spin drying only.

Option Functions

You can select a proper option depending on the type of laundry and the condition of pollution. Read the following descriptions and select a proper option.

- Different options are available depending on the model. Make sure to check your washer model.

Option functions	Descriptions
세탁	An option to change your washing method.
헹굼	An option to change the number of rinsing.
탈수	An option to change the level of spin drying.
예약	An option to finish washing within time.
버튼 잠그기	An option to prevent accidents caused by children manipulating the buttons while washing is in progress.
통살균	An option to keep the washing bucket clean by sterilizing germs within the washing bucket (Refer to 'Cleaning Washing Bucket').
빨래추가	An option to inject additional laundry or to remove alien substances while the washer is operating.
스팀	An option to wash old stains or sterilize inner wears.
원격제어	An option to control the waster remotely through the smartphone app.
내마음	An option to designate and save frequently used washing methods.
터보샷	An option to reduce the washing time.
구김방지	An option to reduce wrinkles in laundry.
불림	An option to clean old stains by swelling laundry before the main washing process begins.
애벌세탁	An option to pre-wash severe stains in your laundry before the main washing process begins.

Option functions	Descriptions
강력	An option to increase the level of washing compared to the standard washing when you want to remove severe stains.
표준	An option to do general washing by using the default setting for all cycles.
적은때	An option to use when there is less pollutions than general washing.
행금추가	An option to add the number of rinsing cycles.
안심행금	An option to use a greater amount of water for more than three times of rinsing cycles.
온수행금	An option to remove fine detergent materials remaining in textile.
물온도	An option to change the water temperature.
버튼음	An option to turn on/off the sound heard when the button is pressed.
배수멈춤	An option to prevent automatic draining after washing is finished.
건조	An option to change your drying method.
표준건조	An option for general drying.
표준/ 일반건조	
바람건조	
터보건조	An option to dry general clothes by reducing the time.
강력건조	
시간건조	An option to dry laundry for a fixed period of time.
시간선택	
다림질건조	An option to dry laundry that required ironing.
다림질용	

Using Washing Cycles

Before using the washer, make sure to read ‘Handling Laundry’, ‘Using Detergent or Fabric Softener’ and follow the instructions given in those chapters.

표준세탁, 표준, 일반세탁 Cycles

Use the cycles for general washing.

NOTE

- If you press the **동작/일시정지** button without selecting cycles, the Standard Washing cycle operates.
- While the washing is going on, if you want to change the setting, press the **동작/일시정지** button to stop first and then press the relevant buttons.
- Your front load washer drops laundry soaked in water from the top to the bottom. So, if you wash towel, then strands are likely to lie down after washing. In this case, use fabric softener. If the washer supports the drying function, then dry laundry for one hour after spin drying is finished. Laundry will become much more softer.
- If your laundry is wet, then the washing time can get longer.
- Turbo shot is automatically selected.

란제리, 울/섬세 Cycle

Use the cycles when you want to wash fine textile such as inner wear that is likely to get deformed or damaged.

NOTE

- Select a proper type of neutral detergent.
- The adequate amount of laundry is less than 1 kg.
- To prevent damages to laundry, the drum will move softly to the left and the right.
- Check if your clothes can be washed in water. Put it into the washer only if so.

란제리/울 Cycle

A cycle to wash fine textile that are likely to shrink or deform.

NOTE

- To reduce damages to textile and improve the washing power, use special neutral detergent for wool such as wool shampoo or essence.
- To prevent damages to laundry, the drum will move softly to the left and the right.
- The adequate amount of laundry is less than 4 kg.
- If the washer supports the steam function, the steam option is not selected to prevent fabrics from shrinking.
- If the washer has a drying function, you can not select the drying option in this cycle.
- Check if your clothes can be washed in water. Put it into the washer only if so.

알뜰살음 Cycle

Select this boiling washing cycle to sterilize and whiten cotton inner wears, or baby clothes.

NOTE

- Only use 1/2 of the recommended amount of detergent by the maker.
- The washer uses its own heating system to heat water.
- If only the cooling water hose is connected, or if the hot water faucet is closed, then the heating will take place at lower temperature than the setting.
- If only the cooling water hose is connected, the cycle will operate. The washer uses its own heating system to heat water.
- If the hot water is supplied, it will help energy saving.
- Bubble removal function: If too much detergent is used, the bubble removal function may operate.
- Draining water temperature reduction: After boiling-washing, cold water is supplied briefly several times to prevent damages to laundry caused by sudden supplies of cold water and to reduce the drain water temperature.
- The recommended amount of laundry is 3 kg or less.

표준살음 Cycle

Select this boiling washing cycle to sterilize and whiten cotton inner wears, or baby clothes.

NOTE

- The adequate amount of laundry for the Standard Boiling cycle is less than 1.5 kg.
- Do not wash white or bright color laundry with dark color laundry that can discharge colors.

소량살음(3 kg) Cycle

Use this boiling washing cycle to sterilize and whiten clothes weighing less than 3 kg.

찌든때, 찌든때(불림) Cycles

Select this cycle to swell and remove old stains from laundry by heating water at 60 °C.

NOTE

- If the hot water is supplied, it will help energy saving.
- The adequate amount of laundry for the 찌든때 cycle is less than 3 kg.
- Do not insert fine textile such as wool or silk, clothes likely to lose colors.

아기옷 Cycle

Select this cycle to wash your baby clothes hygienically.

NOTE

- Select a proper type of neutral detergent.
- To remove ticks and to sterilize clothes, the high temperature steam will be automatically used. It cannot be deactivated.
- Pre wash stains caused by foods, sweat or excrement/urine before the main washing process begins. During the pre washing process, do not add detergent into the detergent box.
- Do not select this cycle to wash fine textile such as wool or silk.
- If the washer has a steam function. it will be automatically selected.

면속옷 Cycle

A simple washing cycle for cotton based inner wears.

NOTE

- The adequate amount of laundry for the Cotton Inner Wear cycle is less than 1 kg.

와이셔츠 Cycle

Select this cycle to minimize damages to Y-shirts that need to be washed frequently.

NOTE

- The adequate amount of laundry for the Y-shirts cycle is less than 1.5 kg.

수건 Cycle

Select this cycle to wash towels with hand wash marks.

NOTE

- The adequate amount of laundry for the Towel cycle is less than 1.5 kg.

이불 Cycle

Select this cycle to wash blanket or mat with hand wash marks.

NOTE

Washer capacity	14 kg or less	15 kg or more
Blanket	2.5 kg or less	4 kg or less
Blanket content		
Size	180 X 220 cm or less	

- If you wash a large sized blanket exceeding the size/weight shown in the table or two sheets of blankets at the same time, be aware that your laundry can get damaged.
- Depending on the volume of blanket, the washing capacity (weight) can be varied.

CAUTION

- If the washer has a drying function, you can not select the drying option in this cycle.
- Do not wash electric blankets, carpets, curtains, foot cleaning seat, or rubber mats. The washer or laundry can get damaged.
- Separate blanket from general laundry. Make sure to wash it sheet by sheet. If you wash more than one sheet at a time, they can get inter-tangled with each other or stuck to one side, making the washing process to be inefficient or making spin drying very difficult.
- Unfold your blanket evenly and make sure to fill up the washing bucket by no more than 80%. If you fold and insert it into the washing bucket, an unbalance can cause malfunctions.
- Make sure to completely insert blanket into the washing bucket. If blanket is placed between the washer door and the rubber packing, it can damage the washer and laundry.

이불살균탈기, 침구클리닝 Cycles

Select this cycle to remove bad odors or moistures from bed items such as blankets by using air only without water washing.

NOTE

- Do not add detergent or fabric softener.
- This cycle uses a small amount of water, so make sure that the faucet is opened.
- You can only wash one unit of bedding. The best effect can be achieved when you obey this rule.
- You can only select from the My Heart, Schedule and Bucket Sterilization options.

CAUTION

- This cycle does not perform water washing or drying. So, do not insert bedding items to wash.
- If you insert stained bedding, it can cause discoloration. So, make sure to remove it first.
- Do not wash electric blankets, carpets, curtains, foot cleaning seat, or rubber mats. The washer or laundry can get damaged.
- Separate blanket from general laundry. Make sure to wash it sheet by sheet. If you wash more than one sheet at a time, they can get inter-tangled with each other or stuck to one side, making the washing process to be inefficient or making spin drying very difficult.
- Unfold your blanket evenly and make sure to fill up the washing bucket by no more than 80%. If you fold and insert it into the washing bucket, an unbalance can cause malfunctions.
- Make sure to completely insert blanket into the washing bucket. If blanket is placed between the washer door and the rubber packing, it can damage the washer and laundry.
- Close any zippers on the bedding.

스팀클리닝 Cycle

Select this cycle to remove unpleasant odors from the laundry.

NOTE

- Do not add detergent or fabric softener.
- This cycle is very effective on cotton textile or cotton mix textile.
- Each time you can wash no more than five Y-shirts for adults. If you put too much clothes or thick clothes, the steam cleaning effect can be deteriorated.
- When you take out clothes after steam cleaning, you will find that they are little wet. Hang them for 10 to 30 minutes before you can wear them again.
- After the cycle is terminated, the washing bucket will periodically rotate for about 30 minutes to prevent wrinkles. You cannot open the washer door. Press any button to unlock and open the door.
- Steam is automatically selected.

CAUTION

- This cycle does not perform water washing or drying. So, do not insert laundry.
- If you insert stained cloth, it can cause discoloration. So, make sure to remove it first.
- Close the zippers or button on your clothes before putting them in it.
- This cycle uses a small amount of water, so make sure that the faucet is opened.
- If you select this cycle consecutively, the cleaning effects will be deteriorated. So, first open the washer door and cool down the inner area before using it again.

Washable Clothes

- Y-shirts, shirts
- T-shirts
- Blouse
- Jumper, duck down jumper, coat
- Cotton pants, jeans
- Blanket, pillow cover, bedding (cotton, mix cotton)
- Cotton, cotton mix

Not Washable Clothes (Can Deform or Shrink.)

- Leather, suits, thin knits, water proof clothes
- Lingerie, stocking, lace, decorated clothes
- Glued clothes, clothes with any kind of adhesives
- Shoes, bags, electric blankets, products containing sponge
- Blanket or cotton blanket with textile longer than 100 mm
- Clothes with artificial wrinkles
- Clothes that cannot be washed by a machine

에어클리닝 Cycle

Select this cycle to remove unpleasant odors from the laundry.

NOTE

- Do not add detergent or fabric softener.



CAUTION

- This cycle does not perform water washing or drying. So, do not insert laundry.
- If you insert stained cloth, it can cause discoloration. So, make sure to remove it first.
- Close the zippers or button on your clothes before putting them in it.
- You cannot add additional laundry while the cycle is operating.
- This cycle uses a small amount of water, so make sure that the faucet is opened.
- Each time you can wash no more than five Y-shirts for adults. If you put too much clothes or thick clothes, the air cleaning effect can be slightly deteriorated.
- This cycle is very effective on cotton textile or cotton mix textile.

Washable Clothes

- Y-shirts, shirts
- T-shirts
- Blouse
- Jumper, duck down jumper, coat
- Cotton pants, jeans
- Blanket, pillow cover, bedding (cotton, mix cotton)
- Cotton, cotton mix

Not Washable Clothes (Can Deform or Shrink.)

- Leather, suits, thin knits, water proof clothes
- Lingerie, stocking, lace, decorated clothes
- Glued clothes, clothes with any kind of adhesives
- Shoes, bags, electric blankets, products containing sponge
- Blanket or cotton blanket with textile longer than 100 mm
- Clothes with artificial wrinkles
- Clothes that cannot be washed by a machine

알러지케어 Cycle

Select this cycle to wash and clean by removing allergy causing agents such as pet hairs, ticks and fungus.

NOTE

- Before using this cycle, check if the type of laundry can be washed in this specific process.
- If you select this cycle, high temperature steam is automatically activated and it cannot be deactivated.
- Do not select this cycle to wash fine textile such as wool or silk or clothes that are likely to lose colors.
- The cycle is most effective when you want to wash bedding or pillow covers where lots of ticks live (Check if water washing is possible).

Regarding the Relax Care Function

After purchasing the product, when you use the washer for the first/second time, the environment of use will be detected. The normal function will start operating at the third time and on.

The Relax Care function only operates during the basic process of the Standard Washing cycle. It will not operate if you manually change the number of rinsing.

조용조용 Cycle

Use this quiet mode washing cycle to reduce the level of noises for night time or when your baby sleeps.

NOTE

- Since the cycle performs spin drying with low noises, the level of drying is lower than the Standard cycle. But it is normal.
- If you adjust the level spin drying on your own, the noise level will get higher.
- To prevent damages to clothes, the max water temperature is set to 60 °C.

기능성의류 Cycle

Select this cycle to wash mountain wears, gym wears or leisure wears.

NOTE

- The washing cycle is suitable for functional clothes such as gore tex, wind stoppers, schoellers or cool max.
- Select a proper type of neutral detergent.
- To prevent damages to clothes, spin drying operates at low speed.
- Steam is automatically activated and the water temperature cannot be changed. If you want to change it, deactivate the steam.
- If you cancel the steam, you can select either water temperature of cold or 30 °C.
- The adequate amount of laundry for the Functional Clothes cycle is less than 3 mountain wears for adults.
- After spin drying your water proofing clothes, there could be some moisture in part of it.
- If you mix functional clothes and general clothes, general clothes may not sufficiently get dry after finished.
- You can not select the drying option in this cycle.

컬러케어 Cycle

Select this cycle to preserve the colors of clothes for a long time after washing.

NOTE

- Add a special agent for color preservation to achieve the best effects on colored clothes.
- To prevent decolorization, select an adequate water temperature.

셔츠한벌드라이 Cycle

Select this cycle to dry one shirt within 20 minutes after spin drying.

NOTE

- Do not add detergent or fabric softener.
- The drying time is fixed for this cycle. If you put too much clothes, the drying efficiency can be deteriorated.
- It is a standalone drying cycle, so use it after spin drying or select the **탈수** option along with it.
- Recommend clothes: No more than one cotton mix Y-shirt.
- Recommended weight: About 200 g.
- Recommended mix ratio: cotton 60 %, polyester 40 %.

스피드워시 Cycle

Select this cycle to quickly wash a small amount of laundry with little pollutions.

NOTE

- Since you are washing a small amount of laundry with little pollutions, only use 1/2 of the recommended amount of detergent by the maker.
- Even if you select the Speed Wash cycle, if the amount of laundry is not small, then the Standard cycle will be used.
- Depending on the amount of laundry, the washing time can vary.
- Even if you use a small amount of laundry, if it is wet, the washing time will get longer due to its weights.
- In this cycle, you wash a small amount of laundry (3 or 4 shirts), so the number of rinsing cycle is automatically set to 2. To improve the rinsing effects, set it to higher than 3.
- Steam is automatically activated and the water temperature cannot be changed. If you want to change it, deactivate the steam.
- If the washer supports the turbo shot function, it will be automatically activated.

스피드 Cycle

Select this cycle to quickly wash a small amount of laundry with little pollutions such as towels used frequently.

NOTE

- The adequate amount of laundry for the Speed cycle is less than 1 kg.

스피드워시(3 kg) Cycle

Select this cycle to quickly wash a small amount of laundry with little pollutions weighing less than 3 kg.

NOTE

- Since you are washing a small amount of laundry with little pollutions, only use 1/2 of the recommended amount of detergent by the maker.
- Even if you select the Speed Wash cycle (3 kg), if the amount of laundry is not small, then the Standard cycle will be used.
- Depending on the amount of laundry, the washing time can vary.
- Even if you use a small amount of laundry, if it is wet, the washing time will get longer due to its weights.
- In this cycle, you wash a small amount of laundry (3 or 4 shirts), so the number of rinsing cycle is automatically set to 2. To improve the rinsing effects, set it to higher than 3.

스피드워시+드라이 Cycle

Select this cycle to wash and dry a small amount of laundry such as 1 to 3 shirts within one hour.

NOTE

- Since you are washing a small amount of laundry with little pollutions, only use 1/2 of the recommended amount of detergent by the maker.
- Depending on the amount of laundry, the washing time can vary.
- Even if you use a small amount of laundry, if it is wet, the washing time will get longer due to its weights.
- The adequate amount of laundry for this cycle is 1 to 3 shirts.
- Finally, steam will be ejected to handle wrinkles.
- If you put other types of laundry than the recommended types, additional drying might be required.

Washable Clothes (1 kg or Less)

- 1 to 3 cotton mix Y-shirts (polyester 40 %, cotton 60 %)
- School wear (summer) (polyester 70 %, rayon 30 %), pants (wool 60 %, polyester 40 %)
- Children's gym wear (polyester 100 %)
- Cotton mix pants (cotton 55 % polyester 45 %)

Not Washable Clothes (Can Deform or Shrink.)

- Leather, suits, thin knits, water proof clothes
- Lingerie, stocking, lace, decorated clothes
- Glued clothes, clothes with any kind of adhesives
- Shoes, bags, electric blankets, products containing sponge
- Blanket or cotton blanket with textile longer than 100 mm
- Clothes with artificial wrinkles
- Clothes that cannot be washed by a machine

찬물세탁 Cycle

Use this energy saving cycle for laundry with relatively less pollutions.

NOTE

- You can only select the cold water for temperature.
- If laundry is has food stains or old stains, it is likely to be washed incompletely. So, separate it and use the Old Stain (Old Stain Swelling) cycle.

소량 세탁 Cycle

Select this cycle to wash a small amount of laundry quickly using 터보샷, 6모션 and 스팀.

스킨 케어 Cycle

Select this cycle to increase the number of rinsing cycles to prevent detergent from remaining on clothes and protect sensitive skin.

장마철 세탁 Cycle

Select this cycle to wash and dry laundry all at once to prevent laundry from being damp.

땀얼룩 제거 Cycle

Select this cycle to remove sweat and stains from the laundry.

한벌 세탁 Cycle

A cycle to wash a slightly stained clothing in the least amount of time.

키즈옷 Cycle

Select this cycle to wash set stains from children's clothing using hot water.

교복 Cycle

Select this cycle to minimize damages to clothes that need to be washed frequently.

정전기 제거 Cycle

Select this cycle to reduce the occurrence of static in the cloth with micro steam and hot wind.

Not Washable Clothes

- Wool clothes or blankets
- Leather products
- Silk products
- Glued clothes
- Lingerie
- Bags
- Sleeves, stockings, tights
- Clothes with the following marks

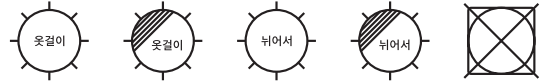

- Products containing sponge
- Blanket with fabric longer than 100 mm
- Shoes
- Electric blankets
- Functional clothes (gore tex, wind stopper, schoeller, etc.)

매일코스 (카테고리)

Press the 매일코스 button to select a desired washing cycle.

위생코스 (카테고리)

Press the 위생코스 button to select a desired washing cycle.

맞춤코스 (카테고리)

Press the 맞춤코스 button to select a desired washing cycle.

헝굼+탈수 Cycle, 안심헝굼

Select this cycle to cover rinsing to spin drying without washing laundry.

NOTE

- Do not add detergent but only add fabric softener.
- Water temperature cannot be selected.
- Cold water is automatically supplied.

Regarding the Relax Care Function

The Relax Care function operates when there are many bubbles causing delays in spin-drying as a result of excessive detergent injection.

The Relax Care function only operates during the basic process of the Standard Washing cycle. It will not operate if you manually change the number of rinsing.

탈수 Cycle

Select this cycle when you only want to spin dry your laundry.

NOTE

- Do not add detergent or fabric softener.

다운로드 Cycle ()

- This content only applies to the NFC model.

Select this cycle when you want to use the Tag On cycle download function by installing the 'LG Smart Washer' app.

If you don't download the cycle app, the '찬물 세탁' cycle will be used.

- 1 Press the **전원** button.
- 2 By using the 'LG Smart Washer' app, check which cycle is downloaded currently.
 - If you try to download cycles on many different smart phones at the same time, the cycle displayed on your smart phone may be different from the actually downloaded cycle on the washer.
 - On the download screen, press the () button to check which cycle is downloaded on the washer.
- 3 Select the **다운로드** cycle on the control panel.
 - Depending on the downloaded cycle, a different setup will be available for selection.
- 4 Press the **동작/일시정지** button.
 - The door will close and the amount of laundry will be automatically detected. After that, water supply and washing will start.

NOTE

- Download cycle is available only for Android based smart phones with the NFC functions.
- The operating position of the NFC function may vary depending on the type of smartphone, and restrictions for using the function may occur for some smartphones due to differences in communication methods.
- You can download a desired cycle from a number of washing cycles using the Tag On function. For a detailed description on each cycle, refer to the 'LG Smart Washer' app.
- Depending on the type of washer purchased, different cycles will be available.
- Download cycle is subject to change depending on the version of 'LG Smart Washer' app.

다운로드 Cycle ()

- This content only applies to the Wi-Fi model.

Select this cycle when you want to use the cycle download function by installing the 'LG Smart Washer' app. If you don't download the cycle app, the '소량 세탁' cycle will be used.

- 1 Press the **전원** button.
- 2 By using the 'LG Smart Washer' app, check which cycle is downloaded currently.
 - If you try to download cycles on many different smart phones at the same time, the cycle displayed on your smart phone may be different from the actually downloaded cycle on the washer.
 - On the download screen, press the () button to check which cycle is downloaded on the washer.
- 3 Select the **다운로드** cycle on the control panel.
 - Depending on the downloaded cycle, a different setup will be available for selection.
- 4 Press the **동작/일시정지** button.
 - The door will close and the amount of laundry will be automatically detected. After that, water supply and washing will start.

NOTE

- 코스 다운로드 function can be used after product registration and Wi-Fi setting. For how to register the product and set Wi-Fi, refer to 'Using the Wi-Fi Function'.
- You can download a desired cycle from a number of washing cycles using the 'LG Smart Washer' app. For a description on each cycle, refer to the 'LG Smart Washer' app.
- Depending on the type of washer purchased, different cycles will be available.
- Download cycle is subject to change depending on the version of 'LG Smart Washer' app.

Using the Optional Functions

세탁

- 1 Press the **전원** button.
- 2 Press the **세탁** button to select the desired type of washing cycle.
After deactivating turbo shots,
 - press the **헹굼** button to turn off all the rinse count lamps.
 - press the **탈수** button to turn off all the spin drying level lamps.
- 3 Press the **동작/일시정지** button.

NOTE

- At the bottom of the display, your selection will be displayed and all other lamps will be turned off.
- After termination of washing only, if there is water inside the washing bucket, then the product performance will be degraded and the lifespan will be shortened. So, water will be automatically drained.

헹굼

- 1 Press the **전원** button.
 - Only inject fabric softener into the detergent box and close the cap.
 - Do not inject detergent.
- 2 Press the **헹굼** button to select the desired number of rinsing.
- 3 Press the **동작/일시정지** button.
 - If you select rinsing only, only water will be drained in the last rinsing cycle.

NOTE

- At the bottom of the display, your selection will be displayed and all other lamps will be turned off.
- After termination of rinsing only, if there is water inside the washing bucket, then the product performance will be degraded and the lifespan will be shortened. So, water will be automatically drained.
- If you select turbo shots, the No Rinsing/Spin Drying menus will be disabled.

탈수

- 1 Press the **전원** button.
 - Do not add detergent or fabric softener.
- 2 Press the **탈수** button to select the desired level of spin drying.
- 3 Press the **동작/일시정지** button.

NOTE

- At the bottom of the display, your selection will be displayed and all other lamps will be turned off.
- If you select turbo shots, the No Rinsing/Spin Drying menus will be disabled.

예약

Use this option if you want to finish washing at certain time.

- 1 Press the **전원** button.
- 2 Select a cycle by turning the cycle selection dial.
- 3 Press the **예약** button to schedule your washing (Ex: If the current time is 1PM and if you want to finish washing at 7PM, then, set it to 6 hours (7-1=6)).
 - The **예약** button will be lit and it will display '3:00'.
 - Until you reach 6 hours on the display, keep pressing the **예약** button.
- 4 Press the **동작/일시정지** button.
 - Washing will be finished at the scheduled time.
 - If you want to cancel your scheduled washing, press the **전원** button.

NOTE

- You can schedule from 3 to 19 hours. You can schedule washing in less than 3 hours.
- Depending on the water supply pressure and temperature, the scheduled time and the actual finishing time can vary.
- Each time you press the **예약** button, the displayed time will increment by one hour.

버튼 잠금 기능 ()

Use this option to prevent accidents caused by children manipulating the buttons while washing is in progress.

Activating or Deactivating the Button Locking Function

- Press the button locking button for about three seconds to activate or deactivate button locking.
- If button locking is activated, you cannot control any buttons except for the power button.
- If you activate it during operation then it will display text saying '버튼 잠금 표시나 버튼 잠금 기능이 설정되었습니다'.

Changing the Cycle or Option while the Button Locking Function is Activated

- 1 Press the button locking button for about three seconds to deactivate button locking.
- 2 Press the **동작/일시정지** button to stop operation.
- 3 After selecting the desired cycle or option, press the **동작/일시정지** button again to resume operation.

NOTE

- After all the processes are finished, the Button Locking function is not automatically canceled. Press the button locking button for about three seconds to deactivate button locking.
- If button locking is activated due to your negligence, then press the button locking button for three seconds to deactivate button locking.
- If you turn on the power while the Button Locking function is activated, the button locking lamp will be lit.

빨래추가

Use this option to inject additional laundry or to remove alien substances while the washer is operating.

Method 1. If the washer is equipped with the 빨래추가 button,

- 1 Press the 빨래추가 button.
 - The washer will stop operating.
 - While draining water to a certain water level to unlock the door or checking the temperature inside the drum, the door will not open.
 - The washer itself will determine if the door can be opened safely, and if so, it will turn off the door locking (🔒) lamp.
- 2 After opening the washer door, adding additional laundry and/or removing foreign objects such as coins or pins, close the washer door.
- 3 Press the 동작/일시정지 button.
 - When you press the 동작/일시정지 button, washing will begin.
 - The washer door will close and the selected cycle or the paused operation will begin.

Method 2. If the washer is not equipped with the 빨래추가 button,

- 1 Press the 동작/일시정지 button.
 - The washer will stop operating.
 - The washer itself will determine if the door can be opened safely, and if so, it will turn off the door locking (🔒) lamp.
- 2 After opening the washer door, adding additional laundry and/or removing foreign objects such as coins or pins, close the washer door.
- 3 Press the 동작/일시정지 button.
 - When you press the 동작/일시정지 button, washing will begin.
 - The washer door will close and the selected cycle or the paused operation will begin.

NOTE

If you want to inject additional laundry or to remove alien substances, check the operational status of the washer.

- The rotating washing bucket will stop and then door locking will be deactivated.
- If the water temperature in the washing bucket is high, then wait until it cools down.

CAUTION

- When adding laundry, make sure to completely push it into the washing bucket. If laundry interferes with door opening, the rubber packing can get damaged, causing water leakages or malfunctions.
- If you forced the washer door to open, then it can cause part damages and safety problems.
- If you try to open the door when there are too much bubbles or water in the washing bucket, bubble and water can overflow, causing burn injuries or the wet floor.

NOTE

- When 원격제어 has been set, only the 전원 button and the 원격제어 button can be used, and a cycle can be selected and started only through the smartphone app.
- The 원격제어 mode will be canceled automatically after washing is complete.

스팀

Use this option to wash old stains or sterilize inner wears.

NOTE

- It provides better washing power with less consumption of electricity.
- High temperature steam will effectively dissolve detergents.
- When the Steam option is selected, if you press the 세탁 button or turn the cycle selection dial, the Steam option will be deselected.
- If you press the 스팀 button right after pressing the 전원 button, then the default setting of the Standard Washing cycle will be automatically selected.
- When steam washing is taking place, as strong steam is sprayed inside the washing bucket, you cannot see the inside clearly but everything is normal.
- The 'Shhh' sound is heard when steam washing is taking place but it does not mean malfunctions.

CAUTION

- Do not insert fine textile such as wool or silk, or clothes likely to lose colors.
- If you press the pause button while steam washing is taking place and then open the washer door, then the remaining steam in the steam spray nozzle can come out for a while. Do not touch it with your body parts. The hot steam can cause burn injuries.

원격제어

You can activate the 원격제어 mode by pressing the 원격제어 button on the control panel of the product. Control the product remotely through the 'LG Smart Washer' app.

Activating or Deactivating the 원격제어 Function

- Press the 원격제어 button for three seconds or more to activate or deactivate the 원격제어 Function.

내마음

Use this option to save your favorite cycles.

- 1 Press the 전원 button.
- 2 Select a cycle by turning the cycle selection dial.
- 3 Press the 옵션 기능 button to add the option function that you want.
- 4 Press the 내마음 button for three seconds to save it.

터보샷

Use this option to reduce the washing time.

NOTE

- Depending on the water supply pressure, the shape of water spray can vary.
- Depending on the washing process, turbo shot will operate in different ways.

구김방지

Use this option to reduce wrinkles on your laundry.

NOTE

- To prevent wrinkles on your laundry, the washing bucket will rotate for a certain period of time after spin drying is finished.
- Use this option to reduce wrinkles on your laundry that may occur after washing is complete. Depending on the type of laundry, the degree of wrinkles may vary.

불림

Use this option to clean old stains by swelling laundry before the main washing process begins.

NOTE

- While the Swelling option is running, the washing bucket will intermittently rotate to swell laundry evenly.

애벌세탁

Use this option to pre-wash severe stains in your laundry before the main washing process begins.

NOTE

- When you pre wash your laundry, only add 1/2 of the amount of detergent required for the main washing process.
- If you select this option, you must inject detergent into the pre washing/main washing detergent box.

강력

Use this option to increase the level of washing compared to the standard washing when you want to remove severe stains.

NOTE

- If you press the strong button, the washing time will get longer.

표준

Use this option to do general washing by using the default setting for all cycles.

적은때

Use this option to use when there is less pollutions than general washing.

헹굼추가

Use this option to add the number of rinsing cycles.

안심행굼

Use this option to use a greater amount of water for more than three times of rinsing cycles.

온수행굼

Use this option to remove fine detergent materials remaining in textile.

NOTE

- This option is only available for some washing cycles.

물온도

Use this option to change the water temperature.

NOTE

- Depending on the washing cycle selected, the water temperature range may vary.

버튼음

Use this option to turn on/off the sound heard when the button is pressed.

배수멈춤

Use this option to prevent automatic draining after washing is finished.

- 1 Press the **전원** button.
- 2 Select a cycle by turning the cycle selection dial.
- 3 Press the **배수멈춤** button.
 - No water will be drained even after rinsing is finished.
- 4 After rinsing, press the **동작/일시정지** button.
 - Water draining and spin drying will start.

건조

Use the cycles for general drying.

NOTE

- Do not exceed the max capacity of drying.
- To prevent wrinkles caused by excessive drying, the drying level it set low. If you need additional drying after termination, then press the **건조** button.
- During the drying process, the cycles of water supply and drain will repeat. This is normal operation to improve the drying performance.
- When you dry chemical textile laundry and take it out from the washing bucket, static electricity can be generated by frictions. If you use fabric softener during rinsing to reduce the level of static electricity.
- Refer to the 'Drying Capacity Label' on the right side to the washing bucket door when you insert laundry. The label indicates the max drying capacity based on dry clothes.
- Except for the Time Drying cycle (time selection), all the Drying cycles can automatically detect the drying condition and the displayed time may differ from the actual operation time. Depending on the drying condition, specific time can be displayed while the drying process is taking place.

CAUTION

- If you violate the instructions in the user manual, then our company will not be held responsible for any consequences.
- If you use the automatic process from washing to drying, then you must make sure that the max drying capacity is not exceeded.
- Depending on the type of textile, laundry can shrink or deform. Check if the type of laundry can be dried in that specific process.
- During the Drying process, water is used to remove moistures. So, make sure to open the faucet.
- If water supply is poor or water pressure is low, then drying cannot be done properly.
- During or after drying, when you want to take out laundry, the zippers, the product inner area, or the washer door can be very hot. So, be careful.
- During the drying, if you press the **빨래추가, 동작/일시정지** button to pause the drying for a moment, then for the safety reasons, open the washer door after the internal temperature of the washing bucket drops. If you open the door too frequently, drying will fail and it can cause malfunctions.
- Set the spin drying level to the max and then perform spin drying and drying. The drying performance will be improved and the drying time will be reduced.

- Do not touch the drain hose/drained water or steam when you perform high temperature washing and drying. Hot steam and water can cause burn injuries.
- When you install the drain hose, make sure that there is no water contained inside the hose. If you hang it like a U shape, the water will accumulate, degrading the drying performance.
- Do not touch the drain hose/drained water or steam when you perform high temperature washing and drying. Hot steam and water can cause burn injuries.

Laundry that Cannot Be Dried

- Wool clothes or blankets
- Leather products
- Silk products
- Glued clothes
- Lingerie
- Bags
- Sleeves, stockings, tights
- Clothes with the following marks



- Products containing sponge
- Blanket with textile longer than 100mm
- Shoes
- Electric blanket
- Functional clothes (gore tex, wind stopper, schoeller and etc.)

Laundry that Can Be Dried

- Y-shirts (polyester 65 %, cotton 35 %) : about 200 g
- Shirts (mix) : about 300 g
- Underwear bottom (cotton 100 %) : about 50 g
- Sleeping wear top/bottom (cotton 100 %) : about 500 g
- Jeans (cotton 100 %) : about 600 g

From Washing to Drying

Use this option to automate the entire processes from washing to drying.

- 1 Press the **전원** button.
- 2 Select a cycle by turning the cycle selection dial.
- 3 Press the **건조** button.
 - Select the desired drying cycle or time.
- 4 Press the **동작/일시정지** button.
 - The door will be locked and drying will start.

Drying Only

Select this cycle when you only want to dry your laundry.

- 1 Press the **전원** button.
 - Do not add detergent or fabric softener.
- 2 Press the **건조** button to select the desired drying cycle/time.
 - **탈수** button will be automatically pressed.
 - If you want to dry only without spin drying, then press the **탈수** button to deactivate it.
- 3 Press the **동작/일시정지** button.
 - The door will be locked and drying will start.

Selecting Drying Cycles

표준건조, 표준/일반건조, 바람건조

Use the cycles for general drying.

터보건조, 강력건조

Use this option to dry general clothes by reducing the time.

시간건조, 시간선택

Use this option to dry laundry for a fixed period of time.

NOTE

- If you select time based drying, the drying process will last only for the fixed time period.
- If you select the Drying cycle, the drying condition will be automatically detected and drying will be finished accordingly. The displayed remaining time can differ from the actual operation time.
- If you want to quickly dry two or three shirts, set the drying time to 30 minutes.
- Depending on the type of laundry, the drying condition can vary. If you want to additional drying time, then press the **시간건조** button.

다림질건조, 다림질용

Use this option to dry laundry that required ironing, such as Y-shirts.

NOTE

- The drying process will be finished when your laundry is little wet, which is suitable for ironing.

CLEANING

Cleaning the Detergent Box

While gently pressing the fabric softener cap, pull it forward to remove the detergent box (Detergent box may look different depending on the washer model).

- Using a toothbrush, thoroughly clean the detergent box inside and outside.

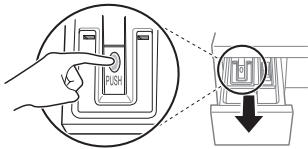

Open the sliding detergent box door and pull the detergent injection hole rim and the fabric softener cup out.

- Using a toothbrush, thoroughly clean the detergent box inside and outside.

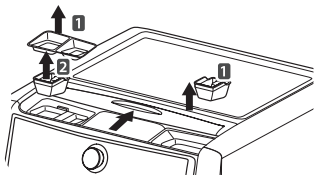

⚠ WARNING

- Do not directly spray water to it. It can cause fire or electrical shock.

NOTE

- Clean the detergent box about once a week. It will be maintained clean at all times.

Cleaning the Washing Bucket

- 1 Inject chloride based whitening liquid (54 ml) into the liquid detergent injection hole or inject chloride based whitening powder (54 g) into the main washing detergent injection hole (For a Commencer washer, inject oxygen based whitening agent (10 ml)).
- 2 Use the **통살균** cycle to clean the washing bucket.

⚠ CAUTION

- Do not let your child or pet go into the washer. It can cause injuries or suffocation.
- If you use acidic cleaner, it can cause discoloration, or corrosions, Do not use it.
- When cleaning the washing bucket, do not inject laundry into it. It can cause severe damages to laundry.

NOTE

- Washing Bucket Sterilization Auto Notice Function (Some models do not support this auto notice function.)
 - Generally, a washing bucket sterilization auto notice appears after approximately 30 uses although may vary depending on the number and type of washer usages.
 - If **ㄷㄷㄷ** blinks on the remaining time display unit when you press the Power button to turn on the power, it indicates that it is time for cleaning the washing bucket. If so, press the **통살균** button to proceed with the bucket sterilization.
 - When you perform bucket sterilization, **ㄷㄷㄷ** will not appear until the next cleaning time.
 - To wash without performing the **통살균** cycle, proceed with the 'Washing' step.
- If you do not completely remove moisture from the inside of the washing bucket, it can generate bad odors and stains (fungus). Leave the door open until there is not moisture inside the washer.
- If you use the product for too long in the following environment,s then germs or fungus in the air can stick to water stains, causing pollutions in the washing bucket. If the level of such pollution is too high, then cleaning can become difficult. So, make sure to clean it at least once a week.
 - If the washer is installed in a humid and shady areas
 - If product is not used or managed for a long time
 - If detergent or fabric softener is used excessively

- Stainless steel washing bucket is resistant against rusts except for the following cases. When rusts are generated, use a sponge or soft cloth soaked in cleaning liquid (neutral agent) and wipe it off thoroughly (Do not use metallic scrubbers).
 - If steel products (pins, hair pins) that can easily generate rusts are left too long in the washing bucket.
 - If you use water with excessive iron for too long
 - If you use whitener for washing and left it too long in the washing bucket
- If you wish to use chloride based whitening liquid, it is recommended to use the Washing Bucket Cleaner.

Cleaning the Water Circulation Filters

Open the washer door, and find the water circulation filter in the upper center of the rubber packing. Remove alien substances from it.

- If the water circulation filter has alien substances in it, it will interfere with water circulation.

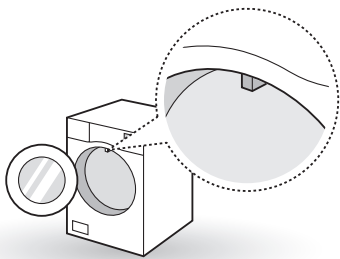

Cleaning the Rubber Packing

- 1 Dilute oxygen based whitener (5 g) in lukewarm water (5 l) and after then wear a rubber glove and wipe off the rubber packing thoroughly with diluted whitener (1000X dilution).

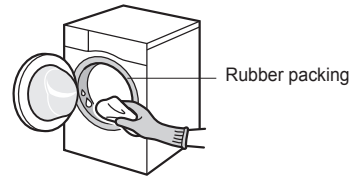

- 2 Using a dry patch, remove water from the rubber packing. Leave the washer door open until it is completely dried.

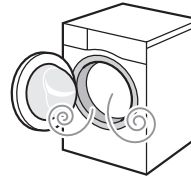

NOTE

- If you don't dilute whitener, it can cause the rubber packing or other parts to malfunction.
- Clean the rubber packing at least once a month.

Cleaning the Water Supply Inlet Net

If the pressure of water into the detergent box is too low, or the net is clogged by wastes, the washer with time displays will indicate **1E** and the washer with an LCD will display warning messages.

- 1 After closing the faucet, separate the water supply hose connected to the rear of the washer.

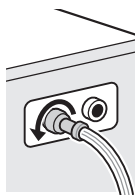

- 2 After taking out the net with your hands or clipper, use a toothbrush to remove wastes from it.

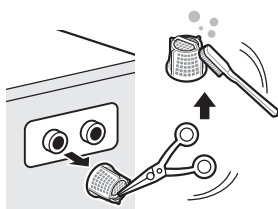

NOTE

- To prevent wastes from clogging the water supply inlet net, periodically clean it. If the net has alien substances such as rusts, sands or stones, water supply will be interfered.

Cleaning the Discharge Pump Net

If the net is clogged by wastes, the washer with time displays will indicate **0E** and the washer with an LCD will display warning messages.

- 1 Open the service cover at the bottom of the washer (Some models have drawers instead).
 - If there is a handle to the cover, while pressing it down, pull it forward.
 - If there is no handle, then pull it forward while pressing it down by using a coin on the hole at the cover top.

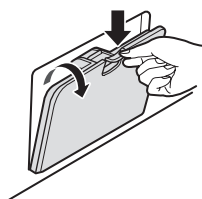

- 2 Remove the residual water removal hose and open the cap to remove water from the inside of the washer.

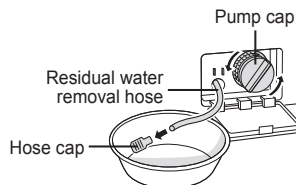

- 3 Turn the pump cap to remove the net and clean it.

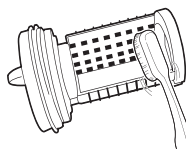

4 When the cleaning is finished, re-assemble the hose cap and the pump cap into the original positions and close the service cover.

- Do not push in the residual water removal hose. Just insert back to the original position.
- Securely fix the pump cap. It can cause water leakages.

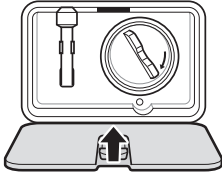

⚠ CAUTION

- Before opening the pump cap, see if there is hot water inside the washing bucket. Hot water can cause burn injuries.
- If you do not assemble the hose and pump caps correctly, it can cause water leakages.

Smart function

Using the Tag On Function ()

- This content only applies to the NFC model.

Installing the App

On your smartphone, you can install the 'LG Smart Washer' app and use your washer more conveniently.

The app can be installed through the Google Play Store or the NFC function.

For more on how to use the 'LG Smart Washer', refer to help in the app.

Installing from Google Play Store

- Search and install 'LG Smart Washer' from the Google Play Store on your smartphone.

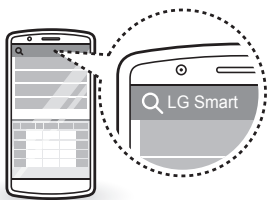

Installing through the NFC Function

- Activate the NFC function on the smartphone. For more on how to use, refer to the smartphone user manual.
- Hold the smartphone to the Tag On mark.

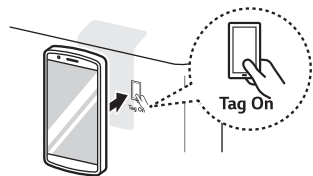

Registering the Product

- 1 Open the 'LG Smart Washer' app.
- 2 Select **스마트 모델** and select the product you have purchased.
- 3 When a **Tag On** or **NFC related message** appears on the smartphone screen, press the **확인** button and activate the NFC function.
- 4 Follow the instructions shown on the smartphone screen.

Using the App

You can use various functions through your smart phone as follows by opening the 'LG Smart Washer' app.

- Smart download cycle
- One-touch washing
- Smart diagnosis
- Laundry assistant

NOTE

- For more on how to use these functions, refer through the '체험하기' menu on the 'LG Smart Washer' app.
- Only an Android based smartphone with the NFC function can use the Tag On function.
- The operating position of the NFC function may vary depending on the type of smartphone, and restrictions for using the function may occur for some smartphones due to differences in communication methods.
- The content of the manual varies depending on the version of 'LG Smart Washer' app. It is subject to change without separate notice to the users.

Using the Wi-Fi Function ()

- This content only applies to the Wi-Fi model.

Installing the App

On your smartphone, you can install the 'LG Smart Washer' app and use your washer more conveniently. The app can be installed through the Google Play Store. For more on how to use the 'LG Smart Washer', refer to help in the app.

Installing from Google Play Store

- Search and install 'LG Smart Washer' from the Google Play Store on your smartphone.

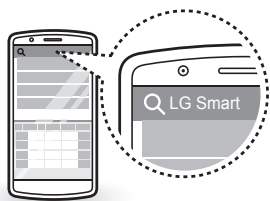

Signing Up for Membership

If you wish to use the 'LG Smart Washer' app, sign up for membership from the smartphone.

- 1 Open the 'LG Smart Washer' app on the smartphone and press the **로그인** button.
- 2 Press the **회원가입** button at the bottom of the screen.
- 3 Agree to the Terms and Conditions and enter member information in the order according to the membership procedure, then press the **가입하기** button.
- 4 A membership confirmation e-mail will be sent to the entered e-mail address. Access your e-mail account and press the **인증하기** button to complete the membership procedure.

NOTE

- To login,  press on the top right side of the screen or press **로그인** at the bottom.
- The e-mail address you entered when signing up for membership will become your ID.
- You can also sign up for membership at <http://kr.smartthinQ.com>.

Registering the Product and Setting Wi-Fi

- 1 Execute the 'LG Smart Washer' app from the smartphone and login.
- 2 Select **드럼형** from the options shown on the screen.
 - If a **Tag On** or **NFC related message** window appears, press the 'Cancel' button.
- 3 Press the **Wi-Fi 모델** button at the bottom of the screen.
- 4 The list of available wireless routers will be displayed on the 'Wi-Fi 네트워크' item. Select the network name you wish to use.
 - In case the password has been set for the wireless network, when you enter the password and press the **연결** button, a message window saying **연결중** will appear and then disappear.
- 5 Turn on the power to the product and press the **예약** button for 3 seconds or more.
 - The Wi-Fi icon will blink on the screen.
- 6 When the product and the app have been connected successfully, a message saying **제품등록이 완료되었습니다** will be displayed on the bottom of the screen.
 - Along with a connection sound, a Wi-Fi shaped icon will be on the product display unit and the product will be connected to the wireless router.

NOTE

- Only 2.4 GHz is supported for wireless frequency of Wi-Fi.
- When registering the product, make sure that the Wi-Fi function of the smartphone has been activated.
- The product registration or modification can be done from **설정**.
- If a wireless router has been changed (device change, mobile carrier, etc.) or the password has been changed, press **제품 등록 설정/변경 - 스마트 모델** on the **설정** menu at the bottom of the app screen and repeat Steps 2 to 6 above.
- If the product is far away from the wireless router, the connection may not be made smoothly.
- The connection may not be made due to the network environments. If the connection cannot be made, contact the network administrator or the Internet service company.
- Make sure to use English characters, numbers or a combination of English characters and numbers for the wireless router SSID (name of wireless router shown when searching for Wi-Fi).
- The content of the manual varies depending on the version of 'LG Smart Washer' app. It is subject to change without separate notice to the users.

Using the App

You can use various functions through your smart phone as follows by opening the 'LG Smart Washer' app.

- Smart remote control
- Smart notice
- Smart download cycle
- One-touch washing
- Smart diagnosis
- Laundry assistant
- Energy monitoring

NOTE

- For more on how to use these functions, refer through the '체험하기' menu on the 'LG Smart Washer' app.
- The smart functions provided by LG may vary depending on the model.
- The content of the manual varies depending on the version of 'LG Smart Washer' app. It is subject to change without notice to the users.

Wireless Product Specifications

The relevant wireless equipment has a possibility of radio interference. Therefore, any service relating to the safety of life cannot be provided.

Operating frequency	2412~2472 MHz
Applied output	IEEE 802.11 b/g/n: 10 mW/MHz
Modulation type	QPSK, OFDM
Form of radio wave	G1D, D2D
Communication mode	Semi-duplex operation

Information on Open Source License

Visit <http://opensource.lge.com> to obtain source codes included in this product which are developed under GPL, LGPL, MPL and other open source licenses.

You can download details and copyright information of all relevant licenses and disclaimers as well as the source codes.

If you request open source codes of software loaded on this product within three years after purchasing this product by sending an e-mail to opensource@lge.com, we will provide the requested source codes in a CD-ROM at the minimum cost required for media and shipping expense.

Smart diagnosis ()

Use this function to contact LG Electronics service center and make an accurate diagnosis when the product operates abnormally or a failure occurs.

- 1 Close the door and press the **전원** button.
- 2 Hold the phone to the smart diagnosis mark.
 - Make sure that the mouthpiece of the phone faces the smart diagnosis mark.

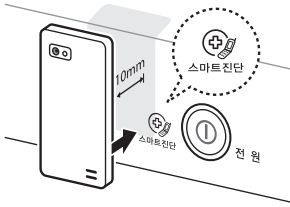

- 3 Press the **물온도** button down to operate smart diagnosis.
 - Place the phone closely to the smart diagnosis mark and press the **물온도** button down until a sound occurs.
 - If you have operated another button or the dial before pressing the **물온도** button, turn the power off and operate again from the beginning.
- 4 Do not remove the phone from the product while data is being transmitted.
 - Place the phone to the smart diagnosis mark continuously and wait while data is being transmitted for smart diagnosis. The remaining time for data transmission will be displayed on the screen.
 - The transmission sound may be unpleasant.
 - Do not remove the phone until the transmission sound stops in order to make an accurate diagnosis.
 - You can stop the diagnosis function and transmission sound by pressing the **전원** button.







- 5 After data transmission is finished, receive the explanation on the diagnosis result from the customer service representative.
 - When data transmission is finished, the product will turn off automatically within a few seconds along with the display of data transmission complete. Receive the explanation on the diagnosis result from the customer service representative and take appropriate measures.

NOTE

- The diagnosis function may be limited due to differences in call quality in the area.
- You can receive better service by using the home phone which has excellent communication performance.

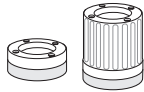
SEPARATELY SOLD ACCESSORIES FOR INSTALLATION



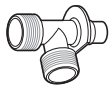
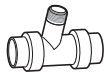
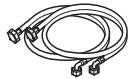
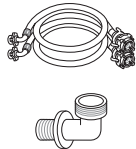
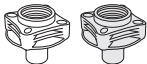
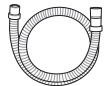
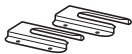





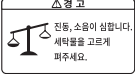
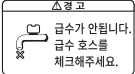

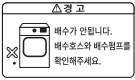

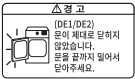

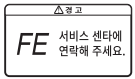
Nationwide LG service centers sell necessary accessories for installation. You must use authentic accessories provided by LG Electronics (If not, the product performance will be degraded and the lifespan will be reduced).

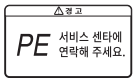
Name	Shape	Type	Usage and methods
Height adjusting plate		<ul style="list-style-type: none"> For the height of 1 cm For the height of 5 cm 	<ul style="list-style-type: none"> Use this part to make sure the product is installed on a level ground. You must assemble the plastic holder and the rubber hold before use. To adjust to the height of 2 to 4cm, place 1cm plastic holder on top of each other.
Slipping prevention seats			<ul style="list-style-type: none"> If you install the product of a slipper tile, its position can be shifted during operation. So, attach the slipping prevention seats first before installing the product.
Extended water hose		<ul style="list-style-type: none"> For cold water (1 m, 2 m, 5 m) For hot water (1 m, 2 m, 5 m) 	<ul style="list-style-type: none"> Use it to extend the length of water supply hose. You must use the water supply hose connector when connecting water supply hoses.
Water supply hose connector			<ul style="list-style-type: none"> Use it to extend the length of water supply hose.
		<ul style="list-style-type: none"> For additional installation of washers 	<ul style="list-style-type: none"> Use it to install two units of washers.
Water drain hose connector		<ul style="list-style-type: none"> For additional installation of washers 	<ul style="list-style-type: none"> Use it to install two units of washers.
Water supply hoses for additional installation of washers		<ul style="list-style-type: none"> 1.25 m 	<ul style="list-style-type: none"> Use it to install two units of washers.
Water supply hose set		<ul style="list-style-type: none"> Cold water hose (1.25 m) 1 EA Hot water hose (1.25 m) 1 EA Water supply hose connector 1 EA 	<ul style="list-style-type: none"> You can purchase additional water supply hoses if you lost them.
Screw type water supply hose plug		<ul style="list-style-type: none"> For cold water (blue) For hot water (orange) 	<ul style="list-style-type: none"> Use it if the tip of faucet looks like a screw or nipple.
Extended drain hose		<ul style="list-style-type: none"> 0.5 m, 1 m, 1.6 m 	<ul style="list-style-type: none"> Use it to extend the length of water drain hose. In the shipping condition, it is assembled with an extender.
Conduction prevention brackets			<ul style="list-style-type: none"> To prevent injuries caused by the washer, follow the instructions in the manual when you install it.

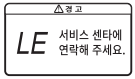
THINGS TO CHECK BEFORE REPORTING PROBLEMS

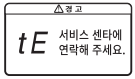
While using the product, if you see these alarms, do not report problems immediately, but check the following items first (Different alarms will be displayed depending on the type of product purchased).

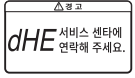





Alarms	Cause	Troubleshooting
 <p>△경고 진동, 소음이 심합니다. 세탁물을 고르게 피주세요.</p>	<p style="text-align: center;">UE</p> <p>Spin drying generate lots of noises or vibrations.</p> <p>Is laundry inclined to one side?</p> <p>Is the product installed on a level ground?</p> <p>Did you remove the fixing bolts?</p> <p>Water is not drained.</p> <p>Did you wash only one doll or knit?</p> <p>Did you wash together blankets made of different textile?</p> <p>Is laundry materials not unfolded properly?</p>	<ul style="list-style-type: none"> • Evenly spread laundry. • Install it on a firm and flat ground. Check the levelness to see if there is any awkward movement. • Remove the fixing bolts. • It is hard to spin dry a doll, as it is inclined to a certain side. Evenly spread knits and try to drain water again. • Regardless of its size, spin dry one sheet at a time. • Press the 동작/일시정지 button to deactivate UE and evenly unfold laundry and proceed with spin drying.
 <p>△경고 급수가 안됩니다. 급수 호스를 체크해주세요.</p>	<p style="text-align: center;">IE</p> <p>Water supply is stopped or water pressure is too low.</p> <p>Is the faucet closed?</p> <p>Is the water supply cut off?</p> <p>Is the faucet or water supply hose frozen?</p> <p>Is the water pressure low or the water supply inlet net clogged?</p> <p>Is the water supply hose connected to the cold water valve?</p> <p>Is the water supply hose bent?</p> <p>Water leaks from the joint of the water supply hose.</p> <p>Is the water supply hose correctly connected to the faucet?</p>	<ul style="list-style-type: none"> • Open the faucet. • Check other faucets. • After closing the faucet, use a hot water cloth to melt the water supply hose's both joints. • Take out the net from the water supply inlet and remove alien substances. • Connect the water supply hose to the cold water valve. • Straighten the water supply hose to avoid bending. • Securely fix the water supply hose, so that it is firmly attached to the faucet.

Alarms		Cause	Troubleshooting
 <p>⚠ 경고 물이 안됩니다. 배수호스와 배수펌프를 확인해주세요.</p>		<p>Water is not drained at all or too slowly.</p> <p>Is the water drain hose installed at the height of 1 m or lower?</p> <p>Is the water drain hose lowered?</p> <p>Is the water drain hose bent or is it clogged because of the high door sill?</p> <p>Is the inner area of the product frozen?</p> <p>Is the water remaining in the drain hose or pump frozen?</p> <p>Are metallic substances in the drain pump such as coins, or pins causing it to stop?</p>	<ul style="list-style-type: none"> • Make sure that the height of water drain hose is below 1 m. • Lower the water drain hose. • If the water drain hose is bent, then alien substances can interfere with draining. So, place it on a flat ground. • Refer to 'Managing Freezing in Winter'. • Use the warm water at temperature of 50~60 °C to melt it. • Turn the pump cap and remove alien substances from the net.
 <p>⚠ 경고 (DE1/DE2) 물이 제대로 말리지 않았습니까? 물을 끝까지 말아서 달라주세요.</p>		<p>Did you operate the washer without closing the door completely?</p> <p>Is the washing bucket rotating or is the water temperature inside the washing bucket higher than 45 °C or is there lots of water in the washing bucket after supplying water?</p>	<ul style="list-style-type: none"> • Close the washer door by pushing it completely. • Check if you can safely open the washer door.
 <p>⚠ 경고 FE 서비스 센터에 연락해 주세요.</p>		<p>Does it repeat supplying and draining water?</p>	<ul style="list-style-type: none"> • If the water supply valve is abnormal the FE error will appear. Remove the power plug and contact the LG Electronics service center.
 <p>⚠ 경고 PE 서비스 센터에 연락해 주세요.</p>		<p>Is water not controller properly?</p>	<ul style="list-style-type: none"> • If the water control sensor is abnormal, the PE error will be displayed. Remove the power plug and contact the LG Electronics service center.
 <p>⚠ 경고 LE 서비스 센터에 연락해 주세요.</p>		<p>The washing bucket is not rotating.</p> <p>Are there too much laundry in the washing bucket?</p>	<ul style="list-style-type: none"> • If so, then the washing motor is overloaded, and the washing bucket will not rotate as a result. Remove some laundry from it and restart washing. If the same problem persists, remove the power plug and contact the LG Electronics service center.
 <p>⚠ 경고 tE 서비스 센터에 연락해 주세요.</p>		<p>Is the water not heated properly?</p>	<ul style="list-style-type: none"> • Remove the power plug and contact the LG Electronics service center.
 <p>⚠ 경고 dHE 서비스 센터에 연락해 주세요.</p>		<p>Is laundry not dried?</p>	<ul style="list-style-type: none"> • Remove the power plug and contact the LG Electronics service center.

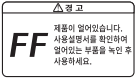
Alarms		Cause	Troubleshooting
		Is laundry not washed or dried?	<ul style="list-style-type: none"> If the sliding detergent box door is open when you select 건조 (cycle or option), laundry cannot be washed or dried. Close the sliding detergent box door completely.

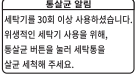
The following signs displayed during operation do not indicate malfunctions.

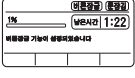
They just indicate that the washer is frozen or indicates the time of Bucket Sterilization or button locking.

Alarms		Cause	Troubleshooting
 <p>△ 경고 FF 자물이 얼어있습니다. 사용상영서를 확인하여 얼어있는 부분을 녹인 후 사용하세요.</p>		Are the water supply/drain hoses or the drain pump frozen?	<ul style="list-style-type: none"> Soak cloth in warm water and melt the water supply hose with it. Inject warm water into the washing bucket and melt the water drain hose and the water drain pump.
 <p>통상코 알림 세탁기를 30회 이상 사용하셨습니다. 위생적인 세탁기 사용을 위해, 통상코 버튼을 눌러 세탁통을 살균 세척해 주세요.</p>		<p>Did you clean the washing bucket at least one to two months ago?</p> <p>Will you clean the washing bucket next time?</p>	<ul style="list-style-type: none"> Select the Bucket Sterilization cycle. If you don't want to use the Bucket Sterilization cycle but to perform general washing, then turn the cycle selection dial or press the button.
 <p>(위생화관) (통상코) 1% MENZ 1:22 버튼잠금 기능이 정상적으로 작동합니다</p>		You pressed the button, but the button does not function properly?	<ul style="list-style-type: none"> Check if the Button Locking function is activated. If you want to deactivate it, press the button locking button for three seconds.

Troubleshooting

While using the product, if you observe the these symptoms, do not report problems immediately, but check the following items first.

Symptom	Cause	Troubleshooting
There are bubbles or rinsing is failed.	Did you use a special detergent for drum washer only?	<ul style="list-style-type: none"> Use a special drum washer detergent.
	Did you exceed the recommended amount of detergent?	<ul style="list-style-type: none"> Do not exceed it.
	Is laundry polluted too little?	<ul style="list-style-type: none"> If so, then use less than the recommended amount of detergent.
Steam comes out of the detergent injection hole or the vent at the rear of the washer.	Did you select the Boling cycle?	<ul style="list-style-type: none"> Steam is generated as water is heated. It is not a sign of malfunction. So, feel free to use the machine.
Water overflows from the detergent box.	Is water too hot?	<ul style="list-style-type: none"> If the water temperature is higher than 50 °C, then bubble can overflow when you inject detergent.
	Is the detergent injection hole dirty or opened?	<ul style="list-style-type: none"> Clean the detergent injection hole and close it firmly. Do not open it while water is supplied.
	Did you exceed the recommended amount of detergent?	<ul style="list-style-type: none"> Do not exceed it.
There is some detergent left in the detergent box.	Is the faucet closed or opened too little?	<ul style="list-style-type: none"> Open the faucet.
	Is the water pressure too low?	<ul style="list-style-type: none"> Clean the water supply inlet net or check the water pressure.
I hear the thumping sound when water is supplied.	Is water being supplied?	<ul style="list-style-type: none"> The sound is heard as the air pressure difference in the water supply pipe forces the water hit the water supply pump. It is not a sign of malfunction.
I cannot turn on the power.	Did you press the 전원 button?	<ul style="list-style-type: none"> Press the 전원 button.
	Is the power plug inserted into the consent?	<ul style="list-style-type: none"> Insert the power plug.
	Is the circuit breaker off?	<ul style="list-style-type: none"> Turn on the circuit breaker.
	Did you connect it to 110 V ?	<ul style="list-style-type: none"> The product is only for 220 V.
The power is off but if I rotate the washing bucket by hands, the power is turned on.	Is the power on automatically?	<ul style="list-style-type: none"> The motor rotates and acts like a power generator. It is normal. The power will be on for a while (sec to minutes) and off automatically.
The washer does not operate.	Did you close the door and press the 동작/일시정지 button?	<ul style="list-style-type: none"> Press the 동작/일시정지 button.
	Is water being accumulated?	<ul style="list-style-type: none"> Wait until the water level is reached.

Symptom	Cause	Troubleshooting
The washer does not operate.	Is the faucet closed?	<ul style="list-style-type: none"> Open the faucet.
Water flows from the bottom of the washer door.	Are aliens substances such as threads or detergents left on the washer door glass or rubber packing?	<ul style="list-style-type: none"> Use a clean cloth to wipe them off.
There are too much noises and vibrations.	Are the fixing bolts removed from the rear of the product?	<ul style="list-style-type: none"> Remove the fixing bolts.
	Is the product leveled?	<ul style="list-style-type: none"> Adjust the level adjusting legs to maintain the levelness.
I smell strange odors from the washer.	Do you smell it during drying?	<ul style="list-style-type: none"> At the initial phase of operation, fluffs from laundry can settle on the heater to cause odors. It is not a sign of malfunction, so free free to use the machine.
	Is it the first time to use the washer?	<ul style="list-style-type: none"> Smell comes from the rubber attached to the washer door. After using the washer a couple of times, it will disappear.
	Do you notice mildew or musty smells while using the washer?	<ul style="list-style-type: none"> Mold and foreign substances inside the gasket may produce mildew or musty smells. Periodically clean the gasket. Foreign substances on the drain pump filter may produce mildew or musty smells. Clean the drain pump filter regularly. If the drain hose is not installed properly, the odor may be emitted because of a backflow of drainage into the tub. Make sure that the drain hose is not kinked or clogged.
The remaining time display is changed.	Is laundry unbalanced or are there too many bubbles?	<ul style="list-style-type: none"> Depending on the environmental factors such as water temperature/pressure or neighboring temperature (season), the water supply time or washing temperature can vary. As a result, the overall washing time will vary (If the washer has the Drying function, it is also affected).
	While the washer is operating, did you switch to other cycle or select other function?	<ul style="list-style-type: none"> As you change the washing cycle or add or remove some functions, the washing time will vary.

Symptom	Cause	Troubleshooting
After spin drying, laundry is still wet.	Is laundry inclined to one side during the spin drying process?	<ul style="list-style-type: none"> If so, it will increase the ground noises or vibrations. So, the number of rotation will be reduced automatically for spin drying, which causes a degradation in the performance. Evenly spread laundry and spin dry it one more time.
	Is there too little laundry?	<ul style="list-style-type: none"> If so, laundry will be inclined to a certain side, increasing the noises and vibrations. As a result, the number of rotations will be automatically reduced for spin drying. Collect more laundry and spin dry them together.
During the Spin Drying cycle, I hear the thumping sound and it repeats stopping and starting.	Did you classify your laundry?	<ul style="list-style-type: none"> If laundry is inclined to a certain side during the Spin Drying process, it can cause vibrations or noises. To prevent these problems, its position is automatically shifted. Divide up your laundry into different types and spin dry them separately.
The spin drying time gets longer.	Is the washing bucket inclined to a certain side?	<ul style="list-style-type: none"> If laundry is inclined to a certain side during the Spin Drying process, it can cause vibrations or noises. To prevent these problems, its position is automatically shifted. The spin drying time can be delayed by max 30 minutes. Divide up your laundry into different types and spin dry them separately.

PRODUCT ENERGY EFFICIENCY CLASS DISPLAYS

According to the efficiency management material operation rules under the Act of Energy Use Rationalization, the energy efficiency class is determined by adopting a proper testing method to examine the amount of electricity and water used to wash the nominal amount of laundry in the Standard cycle.

In the actual washing cycle, depending on the type and amount of laundry, more electricity and water (per unit) can be consumed than indicated by the energy efficiency class.

PRODUCT WARRANTY

The quality warranty period is based on the standard for resolving consumers disputes posted by the Fair Trade Commission.

Model name		
Date of purchase		



128 Yeouidaero, Youdeungpo-gu Seoul City
(20 Yeouido-dong Youngdeungpo-gu Seoul city)

When you request a repair service, you need to present this warranty indicating the date of purchase. This warranty is required when you want to receive a good service, so keep it in a safe place.

1. The content of this warranty guarantees the benefits of warranty for the product.
2. Free quality warranty period starts from the date of purchase. So, mark down the date of purchase (If the date of purchase is not confirmed, then we assume that the quality warranty period starts 3 months after the date of manufacturing or custom clearance).
3. If you use a household product for the sales purpose or as the sales means or if you use it in an abnormal environment, the free quality warranty period is reduced by 50 %.
4. This warranty cannot be issued again.
5. If an additional contract exists for supplies (procurement, host, single product), then the main contract governs the warranty details.

Period of owning main parts

- Washer6 years

Quality warranty period for main parts

- Washer's motor3 years
(The free warranty period for the motor, a main part of washer is three years according to the standard for resolving consumers disputes but we guarantee 10 years of free warranty for DD motors. But the travel expense is charged.)

STANDARDS FOR RESOLVING CONSUMERS DISPUTES

STANDARDS FOR RESOLVING CONSUMERS DISPUTES			
Damage types	Compensations		
	Within the warranty period	After the warranty period	
If a repair service is required as a functional or performance error occurs in the normal condition of use within 10 days from the date of purchase	Product replacement or full refunds	Charged repairs	
If a repair service is required as a functional or performance error occurs in the normal condition of use within 1 month from the date of purchase	Product replacement or free repair	Charged repairs	
If a repair service is required as a functional or performance error occurs in the normal condition of use within the warranty period	If an error occurs	Free repairs	Charged repairs
	If it cannot be repaired	Product replacement or full refunds	Charged repairs
	If it cannot be replaced	Full refunds	Charged repairs
	If a major repair is required within 1 month after the date of purchase	Full refunds	Charged repairs
	※ If an error occurs again after the second time of repairing the same error within the warranty period, or if an error occurs again after the four times of repairing various faulty parts within the warranty period, it is deemed that a repair is impossible.		
If the company lost the product that the consumer returned for a repair service	Product replacement or full refunds	Refund amount is obtained by adding 10 % to the depreciated fixed costs (max: price of purchase).	
A damage caused by not having necessary repair parts within the period of owning main parts	If a repair service is required as a functional or performance error occurs in the normal condition of use	Product replacement or full refunds	Refund amount is obtained by adding 5 % of the price of purchase to the depreciated fixed price (If depreciated price <0, then assume 0).
	If a malfunction is caused by the customer's negligence or fault	Product replacement after collecting the fees for charged repair service.	Refund amount is obtained by adding 5 % of the price of purchase to the depreciated fixed price (If depreciated price <0, then assume 0).
A damage caused during the conveyance.	Product replacement (If a special conveyer is used, we will exercise the rights to ask for compensation).	NA	
A damage caused while the company installs the product	Product replacement	NA	

- The compensation standard above is based on the standard for resolving consumers disputes posted by the Fair Trade Commission.
- Any issues not discussed above will be governed by the standards for resolving consumers disputes.
- Customer center (charged by callers): 080-023-7777
- Device washing, adjustment or instructions for use are not in the scope of malfunctions.

REGARDING THE CONSUMER SERVICE

Consumer's rights

Customer has the valuable rights to receive free services for any malfunctions occurring while using the product for one year after the date of purchase. The free warranty period only applies to the Korean territory. But if a malfunction occurs due to customer's negligence or natural disasters, then service will be charged even within the free warranty period.

Responsibilities for Charged Service (Paid By Customers)

In the following cases, a service will be charged even within the free warranty period.

- If a metallic aine substance such as coins, pins, pens, or memory wire enters into the product to cause malfunctions
- If you drop the product, or impacts cause damages to the product or functional malfunctions
- If due to customer's negligence, liquid such as thinner or benzene damages or deform the product exterior
- If a malfunction occurs as the result of using non authentic LG Electronics parts (To get authentic LG Electronics parts, contact the nearby LG Electronics service center).
- If you want to replace a consumable part that is supposed to wear out during the period of use
- If a malfunction occurs as a customer uses the wrong voltage
- If a part is lost or damaged as a customer disassembles the product on their own
- If simple adjustments are required without disassembling the product or if the product function needs to be explained
- If a malfunction occurs as the result of failing to obey the 'SAFETY PRECAUTIONS' of the LG Electronics user manual. Always follow the 'SAFETY PRECAUTIONS' to use the product for a long time (If you request a repair service when there is no malfunction, fees will be charged. So, carefully read this manual).
- If a malfunction is caused by natural disasters such as thunders, fire, flooding, salt water, gas or earth quakes
- If a malfunction is caused by a customer's negligence
- If you request a service when the circuit breaker goes down nut there is nothing wrong with the product
- If the power consent is bad, if the power plug is not inserted, if a malfunction is caused by external factors such as clogged drain holes or freezing in the winter
- If a malfunction occurs due to the bad power supply or connector failures
- If the original installation location is shifted as a customer requests, or if the product is installed again after moving to a new place
- If a malfunction occurs after someone other than an LG Electronics serviceman repairs or remodels the product
- If a service is requested due to other company products failures even if a customer requests a service with LG Electronics parts
- If a service is requested without fully understanding the exterior defects when a customer purchased a product displayed on floor
- If the water supply is cut off because a customer closes the faucet or the water company stops it
- If a malfunction occurs after using the product for other purposes than washing (removing grain shells)
- If water is not drained because a customer did not clean the drain pump net

PROCEDURE FOR DISPOSING ELECTRONICS WASTES

If You Purchased a New Product

If you purchased a new product from the LG Electronics shop, then the old electronics will be disposed for free when a new product is delivered.

Simple Disposal

If you want to dispose a large sized electronics wastes, then call the resident center or waste disposal company.



LG Electronics service center telephone number

To report complaints or troubles, call (nationwide)

1544-7777, 1588-7777

• **Before making a call**

Make sure that you know the product model name, trouble status, telephone number and address to receive prompt service.

• **When making a call**

Select the product correctly according to the instructions on ARS, You will receive the best service from our special consultant for that product.

Customer center (suggestion or complaints) 080-023-7777

Internet service request

www.lgservice.co.kr

- If you use the internet service, you can conveniently get self diagnosis, service request at the desired time/date and real time PC remote consulting service.
- If you request a in-house service on the internet, we will give you discounts on your repair service (Subject to change depending on the circumstance of the company).



소 비 자 중 심 경 영
공정거래위원회 | 한국소비자원

Consumer Centered Management

This certification mark indicates products and services from customer oriented companies that value their customers most.

Evaluated by the KCA and certified by the FTC. (www.kca.go.kr)



What is an excellent Korean service company?

Under the supervision by the KOAS, the system gives prizes to companies with good service quality and customer satisfaction so that they can be publicized as excellent companies.

