

50UK660H\*  
55UK660H\*  
65UK660H\*

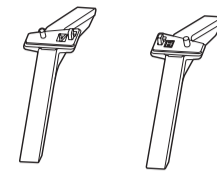

**50/55"**  
a x 4  
(M4 x L20)

**65"**  
a x 6  
(M4 x L20)

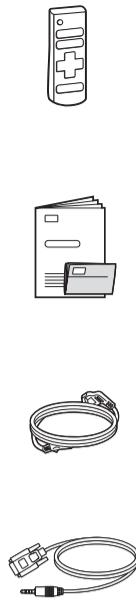
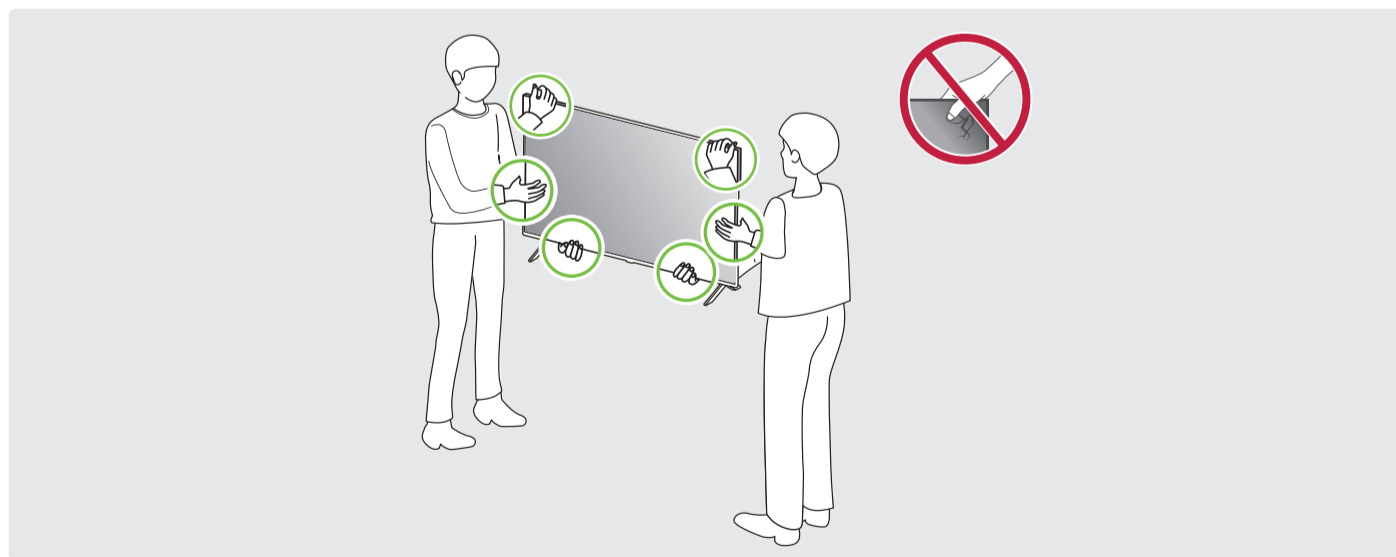
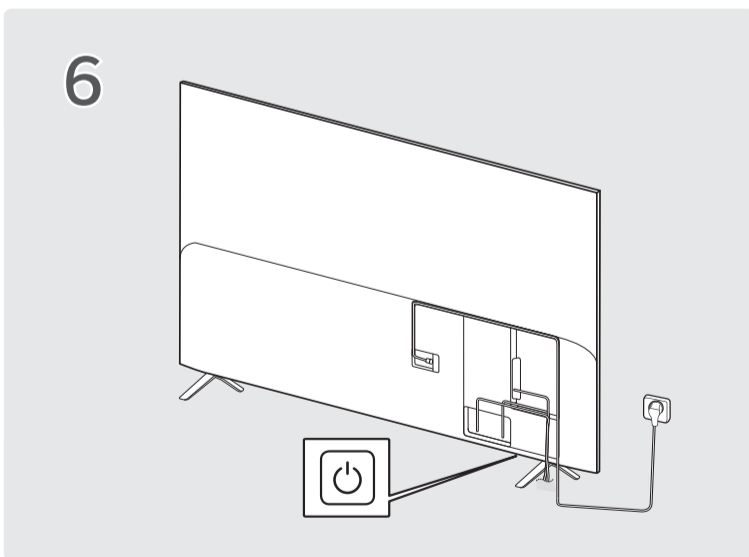
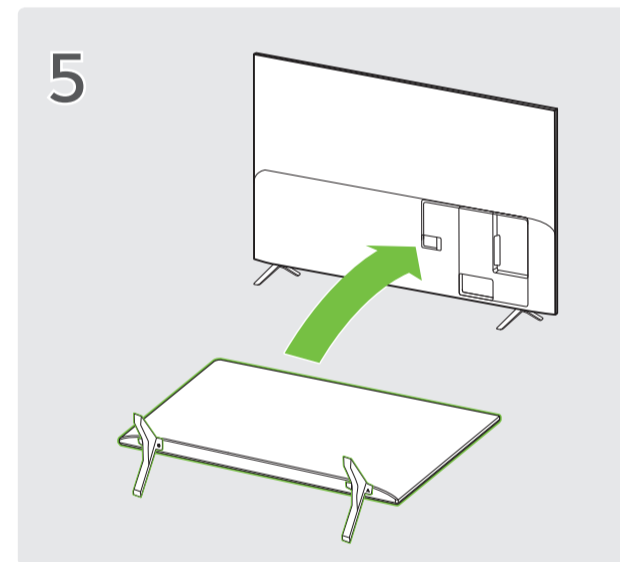
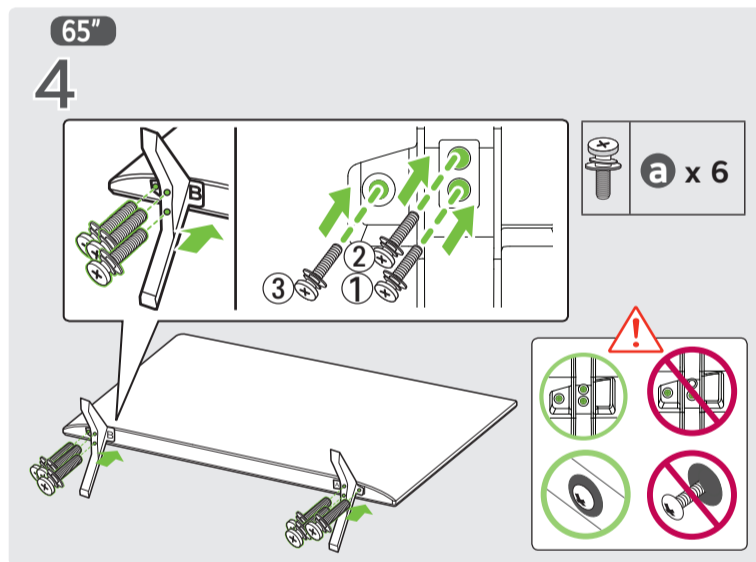
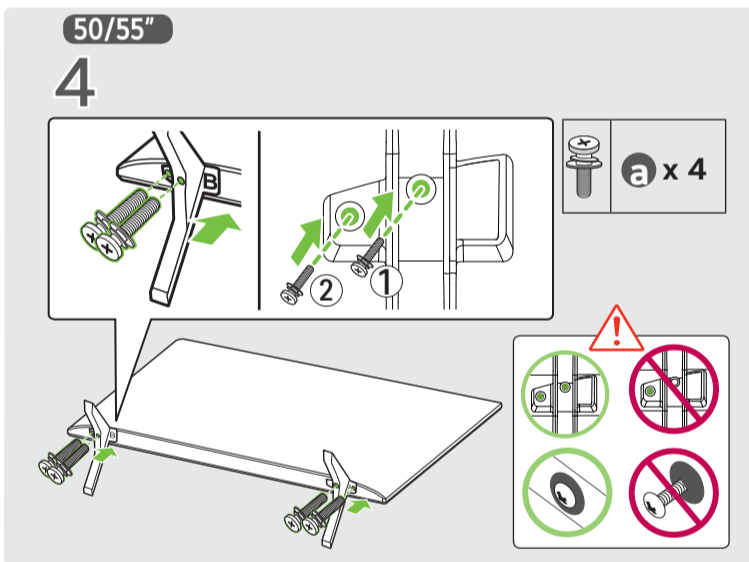
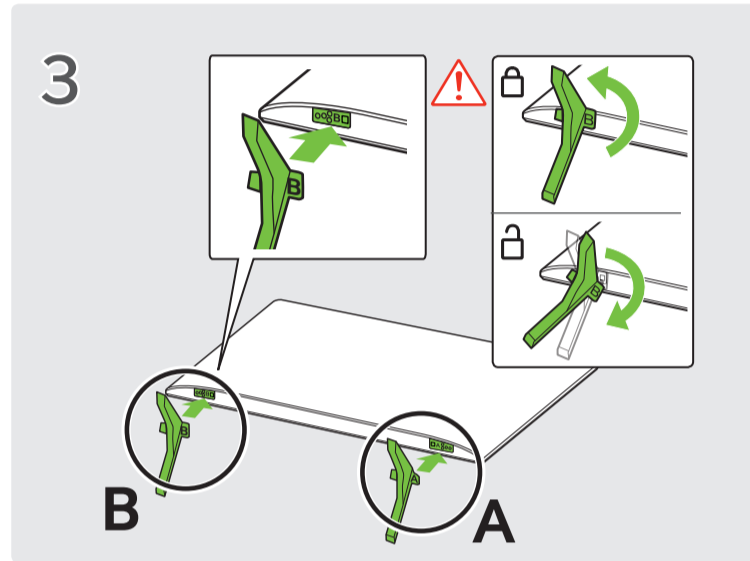
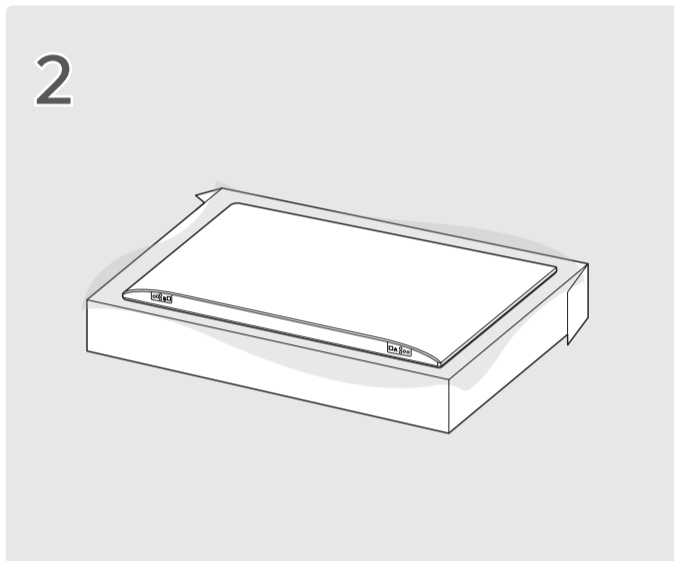
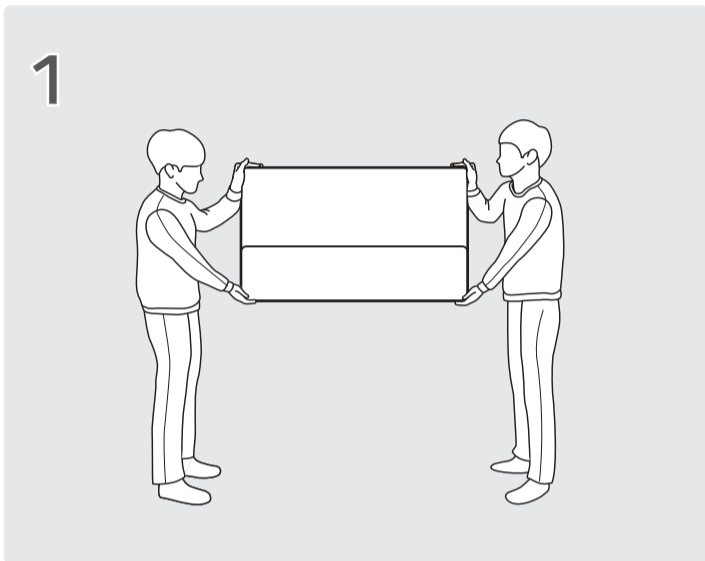

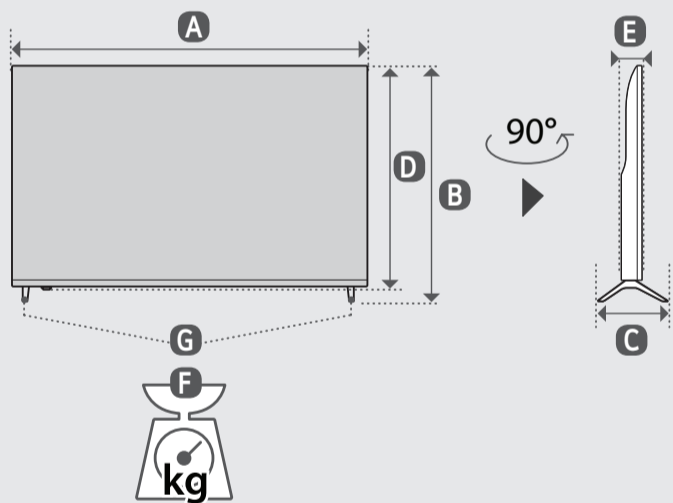
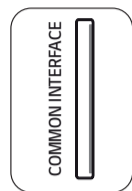
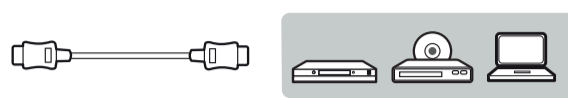
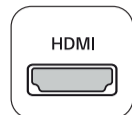
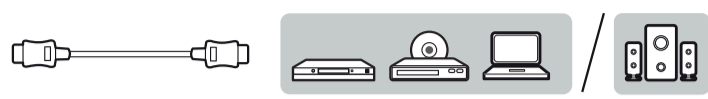
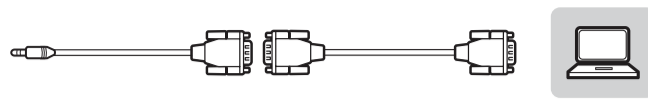
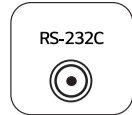
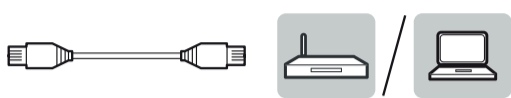
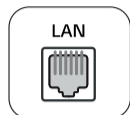
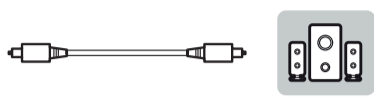
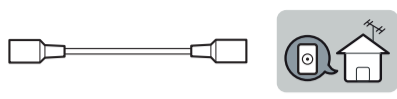
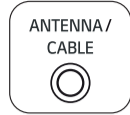

	A	B	C	D	E	F	F - G
	(mm)					(kg)	
50UK660HOLA	1122	718	230	654	67.9	9.5	9.4
55UK660HOLA	1236	780	230	718	67.9	11.6	11.5
65UK660HOLA	1455	904	269	841	67.9	16.7	16.5
Power requirement					AC 100-240 V~ 50/60 Hz		