



OWNER'S MANUAL

DRYER



Before beginning installation, read these instructions carefully. This will simplify installation and ensure that the product is installed correctly and safely. Leave these instructions near the product after installation for future reference.

ENGLISH

RD08NHP5W



52439800
Rev.00_042823

www.lg.com

Copyright © 2023 LG Electronics Inc. All Rights Reserved.

TABLE OF CONTENTS

This manual may contain images or content that may be different from the model you purchased.
This manual is subject to revision by the manufacturer.

SAFETY INSTRUCTIONS

READ ALL INSTRUCTIONS BEFORE USE..... 3
WARNING..... 3

INSTALLATION

Parts and Specifications 9
Installation Location Requirements 11
Leveling the Appliance 12
Stacking Instructions 12
Connecting the Drain Hose..... 13

OPERATION

Operation Overview..... 14
Preparing the Clothes..... 15
Control Panel 17
Programme Table 19
Extra Options and Functions 22

MAINTENANCE

Cleaning after Every Dry 24
Cleaning the Appliance Periodically 26

TROUBLESHOOTING

Before Calling for Service..... 28

SAFETY INSTRUCTIONS

READ ALL INSTRUCTIONS BEFORE USE

The following safety guidelines are intended to prevent unforeseen risks or damage from unsafe or incorrect operation of the appliance. The guidelines are separated into 'WARNING' and 'CAUTION' as described below.

Safety Messages



This symbol is displayed to indicate matters and operations that can cause risks. Read the part with this symbol carefully and follow the instructions in order to avoid risks.



WARNING

This indicates that the failure to follow the instructions can cause serious injury or death.



CAUTION

This indicates that the failure to follow the instructions can cause the minor injury or damage to the appliance.

WARNING

WARNING

To reduce the risk of explosion, fire, death, electric shock, injury or scalding to persons when using this product, follow basic precautions, including the following.

Technical Safety



WARNING - To avoid a fire Risk of Fire and Flammable Materials

- In the appliance enclosure or in the built-in structure, keep ventilation openings clear of obstruction. If not, it can result in a fire.

4 SAFETY INSTRUCTIONS

- This appliance contains R290, a refrigerant that is environmentally friendly but flammable. Do not damage the refrigerant circuit, keep an open flame and ignition sources away from the appliance.
- This appliance is not intended for use by persons (including children) with reduced physical, sensory or mental capabilities, or lack of experience and knowledge, unless they have been given supervision or instruction concerning use of the appliance by a person responsible for their safety. Children should be supervised to ensure that they do not play with the appliance.
- Do not dry unwashed items in the appliance.
- Fabric softeners, or similar products, should be used as specified by the fabric softener instructions.
- Remove all objects from pockets such as lighters and matches.
- Never stop the appliance before the end of the drying cycle unless all items are quickly removed and spread out so that the heat is dissipated.
- The appliance is not to be used if industrial chemicals have been used for cleaning.
- Items that have been soiled with substances such as cooking oil, vegetable oil, acetone, alcohol, petroleum, kerosene, spot removers, turpentine, waxes and wax removers should be washed in hot water with an extra amount of detergent before being dried in the appliance.
- Do not drink the condensed water. Failure to do so may result in food-borne illnesses.
- If the supply cord is damaged, it must be replaced by the manufacturer or its service agents or similarly qualified person in order to avoid a hazard.
- The lint filters must be cleaned frequently.
- Lint must not be allowed to accumulate around the appliance.
- Do not spray dry cleaning detergent directly onto the appliance or use the appliance to dry clothes left with dry cleaning detergent.

- Do not dry clothes stained with oil substances. Oil substances (including edible oils) stained on clothes cannot be completely removed even after washing with water.
- The appliance must not be supplied through an external switching device, such as a timer, or connected to a circuit that is regularly switched on and off by a utility.
- Remove clothes from the appliance immediately when drying is complete or the power is turned off during the drying process. Leaving clothes that have been dried in the appliance unattended could result in fire. Remove clothes immediately after drying, and then hang or lay the clothes flat to cool.
- This appliance is intended to be used in household only.

Maximum Capacity

- The maximum capacity in some cycles for clothes to be dried is **8 kg (Dry)**.
- The recommended maximum capacity for each drying programme may differ. To get good dry results, please refer to **Programme Table** in **OPERATION** chapter for further details.

Installation

- Make sure the appliance is properly installed, grounded, and adjusted by qualified service personnel according to the installation instructions.
- Never attempt to operate the appliance if it is damaged, malfunctioning, partially disassembled, or has missing or broken parts, including a damaged cord or plug.
- This appliance should only be transported by two or more people holding the appliance securely.
- Do not install the appliance in a damp and dusty place. Do not install or store the appliance in any outdoor area, or any area that is subject to weathering conditions such as direct sunlight, wind, rain, or temperatures below freezing.
- Tighten the drain hose to avoid separation.

- If the power cord is damaged or the hole of the socket outlet is loose, do not use the power cord and contact an authorized service centre.
- Do not plug multiple socket outlets, an extension power cable or adapter with this appliance.
- Items such as foam rubber (latex foam), shower caps, waterproof textiles, rubber backed articles and clothes or pillows fitted with foam rubber pads should not be dried in the appliance.
- This appliance must not be installed behind a lockable door, a sliding door or a door with a hinge on the opposite side to that of the appliance, in such a way that a full opening of the appliance door is restricted.
- This appliance must be grounded. In the event of malfunction or breakdown, grounding will reduce the risk of electric shock by providing a path of least resistance for electric current.
- This appliance is equipped with a power cord having an equipment-grounding conductor and a grounding power plug. The power plug must be plugged into an appropriate socket outlet that is installed and grounded in accordance with all local codes and ordinances.
- Improper connection of the equipment-grounding conductor can result in risk of electric shock. Check with a qualified electrician or service personnel if you are in doubt as to whether the appliance is properly grounded.
- Do not modify the power plug provided with the appliance. If it does not fit the outlet, have a proper outlet installed by a qualified electrician.

Operation

- Do not attempt to separate any panels or disassemble the appliance. Do not apply any sharp objects to the control panel in order to operate the appliance.
- Do not repair or replace any part of the appliance yourself. All repairs and servicing must be performed by qualified service personnel unless specifically recommended in this Owner's Manual. Use only authorized factory parts.

- Keep the area underneath and around the appliance free from combustible materials such as lint, paper, rags, chemicals, etc.
- Do not put or other animals pets into the appliance.
- Do not leave the appliance door open. Children may hang on the door or crawl inside the appliance, causing damage or injury.
- Never reach into the appliance while it is operating. Wait until the drum has completely stopped.
- Do not put in, wash or dry articles that have been cleaned in, washed in, soaked in, or spotted with combustible or explosive substances (such as wax, oil, paint, gasoline, degreasers, drycleaning solvents, kerosene, vegetable oil, cooking oil, etc.). Improper use can cause fire or explosion.
- In case of flood, disconnect the power plug and contact the LG Electronics customer information centre.
- Do not push down on the appliance door when it is open.
- Do not use flammable gas and combustible substances (benzene, gasoline, thinner, petroleum, alcohol, etc.) near the appliance.
- If the drain hose or inlet hose is frozen during winter, thaw it out before using the appliance.
- Keep all washing detergents, softener and bleach away from children.
- Do not touch the power plug or the appliance controls with wet hands.
- Do not bend the power cable excessively or place a heavy object on it.

Maintenance

- Remove any moisture or dust from the power plug before securely plugging it into an outlet.
- Disconnect the appliance from the power supply before cleaning the appliance. Setting the controls to the OFF or stand by position does not disconnect this appliance from the power supply.
- Never unplug the appliance by pulling on the power cable. Always grip the power plug firmly and pull straight out from the outlet.

- Do not spray water inside or outside the appliance to clean it.

Disposal

- Before discarding an old appliance, unplug it and cut off the power cable directly behind the appliance to prevent misuse.
- Dispose of all packaging materials (such as plastic bags and styrofoam) away from children. The packaging materials can cause suffocation.
- Remove the door before disposing of or discarding this appliance to avoid the danger of children or small animals getting trapped inside.

INSTALLATION

Parts and Specifications

NOTE

- Appearance and specifications may vary without notice to improve the quality of the appliance.

Front View

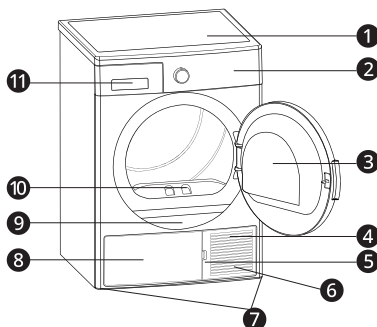

- 1 Top plate
- 2 Control panel
- 3 Door
- 4 Plinth
- 5 Plinth opening slot
- 6 Ventilation grills
- 7 Adjustable feet
- 8 Plinth cover
- 9 Type plate
- 10 Lint filter
- 11 Drawer cover

10 INSTALLATION

Specifications

Asterisk(s) means model variant and can be varied (0-9) or (A-Z).

Description	Value
Model	RD08NHP5W
Power supply	220 - 240 V~, 50 Hz
Product weight	48 kg
Allowable temperature	5 - 35 °C

Dimension(mm)

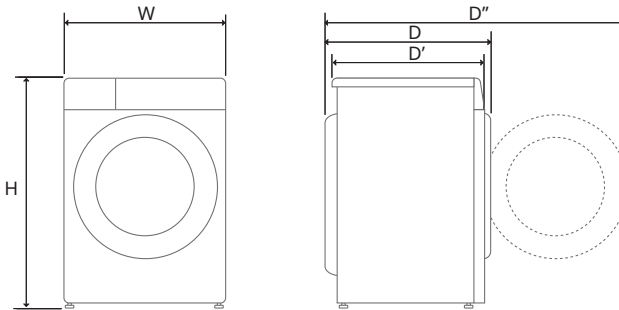

Index	Dimension (mm)
W	600
H	850
D	610
D'	580
D''	1043

Installation Location Requirements

Before installing the appliance, check the following information to make sure that the appliance is installed in the correct location.

Installation Location

⚠ WARNING

- Do not install the appliance around a heat source. The rear side of the appliance must be well ventilated. Failure to follow these instructions may result in problems.
- The appliance is not designed for maritime use or for use in mobile installation such as caravans, aircraft and etc.
- Do not install the appliance as a built-in appliance. It is not suitable for built-in purpose.

NOTE

- For better drying performance, keep the rear of the appliance away from the wall.
- Make sure that the location where the appliance will be installed meets a minimum clearance conditions.
- Install the appliance on a flat hard floor. Allowable slope under the appliance is 1 degree.
- Never try to correct any unevenness in the floor with pieces of wood, cardboard or similar materials under the appliance.
- Install the appliance in a location where service engineers are easily accessible in the event of a breakdown.
- Do not install the appliance next to high-temperature appliances such as refrigerator, oven or stove, and etc. It can cause poor drying performance and delay programme duration. It also adversely affect the proper functioning of the compressor.
- Do not install the appliance where there is a risk of frost or dust. The appliance may not be able to operate properly or may be damaged by freezing of condensed water in the pump and drain hose.

- With the appliance installed, adjust all four feet using a spanner to ensure the appliance is stable, and a clearance of approximately 20 mm is left between the top of the appliance and the underside of any work-top.

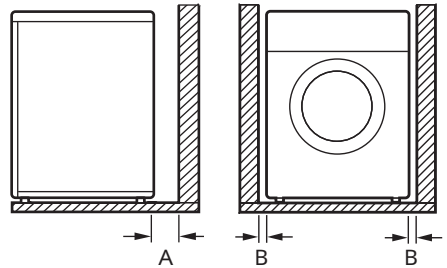

A	100 mm
B	20 mm

Ventilation

- Alcove or under counter
 - Make sure that air circulation around the appliance should not be impeded by carpets, rugs, etc.
- Cupboard
 - Cupboard door must have 2 (louvered) opening, each have a minimum area of 387 cm², located 8 cm from bottom and top of the door.

Ambient Temperature

- Do not install the appliance in rooms where freezing temperatures may occur. Frozen hoses may burst under pressure. The reliability of the electronic control unit may be impaired at temperatures below freezing point.

NOTE

- If the appliance is delivered in winter and temperatures are below freezing, place the appliance at room temperature for a few hours before putting it into operation.

12 INSTALLATION

NOTE

- The appliance performs best at a room temperature of 23 °C.

Electrical Connection

- Do not use an extension cord or double adapter.
- Do not overload the outlet with more than one appliance.
- Connect the appliance to an earthed socket in accordance with current wiring regulations.
- The appliance must be positioned a place close to outlet socket so that the plug is easily accessible.
- Outlet socket must be within 1.5 meters of either side of the location of the appliance.

NOTE

- Always unplug the appliance after use.

Leveling the Appliance

Checking Leveling

Leveling the appliance prevents unnecessary noise and vibration. Check whether the appliance is perfectly level after installation.

- If the appliance rocks when pushing the top plate of the appliance diagonally, adjust the feet again.

NOTE

- Timber or suspended type flooring may contribute to excessive vibration and unbalance. Re-enforcement or bracing of the timber floor may need to be considered to stop or reduce excessive noise and vibration.
- Do not install the appliance on any elevated surface, stand or plinth as it can become unstable and fall causing serious injury and damage.

Adjusting and Leveling the Appliance

When the appliance is not perfectly level, turn the adjustable feet until the appliance no longer wobbles.

- Turn the adjustable feet clockwise to raise or turn the adjustable feet counterclockwise to lower from front-to-back, side-to-side and corner-to-corner.

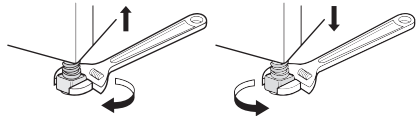

Stacking Instructions

Stacking Kit Installation

When the dryer is placed on the washing machine, the total weight of these products may reach almost 150 kg (when loaded). Place the products on a solid floor that has a load bearing capacity.

In order to put the dryer machine onto the washing machine, a special stacking kit is required as an optional extra. Please contact LG Electronics Customer Information Centre or visit the LG Website at <http://www.lg.com> for purchase. The assembly instruction will be served together with the stacking kit.

- Appropriate Installation Table for Washing Machine and Tumble Dryer

		Tumble Dryer (Depth)	
		56 cm	61 cm
Washing Machine (Depth)	37 cm		
	42 cm		
	53 cm	●	
	56 cm	●	●
	59 cm	●	●
	85 cm	●	●

Connecting the Drain Hose

Using the Laundry Tub to Drain

In products with a heat pump unit, water accumulates in the water tank during the drying process. You must empty the accumulated water after each drying process. Instead of periodically emptying the water tank, you can also use the water drain hose.

Please contact LG Electronics Customer Information Centre or visit the LG Website at <http://www.lg.com> for purchase.

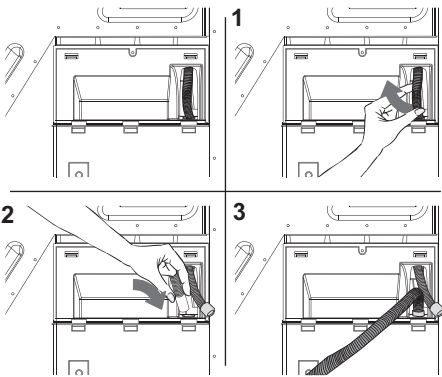

- 1** Pull and take out the end of the hose at the back of the dryer. Do not use any tools to take out the hose.
- 2** Fit one end of the water discharge hose, which is provided with the product, to the slot from which you have removed the hose.
- 3** Fix the other end of the water discharge hose directly to the water outlet or sink.

NOTE

- The hose must be connected in a manner that it cannot be displaced. If the hose comes out during water discharge, there might be flooding in your house.

OPERATION

Operation Overview

Using the Appliance

Before the first cycle, set the appliance to dry for 5 minutes to warm up the drum. Open the door between loads the first few times you use the appliance to allow any odours from the interior of the appliance to disperse.

Children must be supervised so that they do not climb inside the drum.

- 1 Ensure the lint filter and water container are clean.

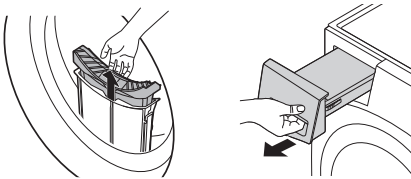

- Open the door and ensure the lint filter is clean. When the filter is full with lint, drying times will be longer than usual.
- Pull out the water container and empty the condensed water. When the water container is full, the appliance may stop during the cycle.

NOTE

- In some instances, LED window may display  icon to inform you that the water container is full. If this occurs, empty the water container.

- 2 Place the clothes into the drum after sorting and close the door.
 - Push the clothes deep into the drum so that the clothes keep away from the door seal. When the clothes get stuck between the door and seal, they may get damaged while drying.
 - The clothes should be sorted by fabric types and dryness level.

- All strings and attached belts of clothes should be well tied and fixed before being put into the drum.

- 3 Choose a drying programme by turning the programme selector knob.

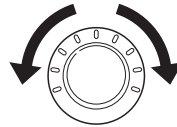

- 4 Press the **Start/Pause** button to start the drying programme.
 - When you press the button, the appliance ventilates the inside of the drum for 10 seconds in order to get the appliance ready for drying operation.

- 5 After the drying programme has finished, open the door and unload the clothes.

CAUTION

- Be careful! The drum inside may still be hot.

- 6 Clean the lint filter and empty the water container.

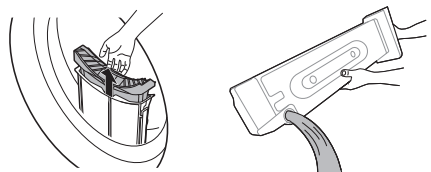

- 7 To help reduce odours from forming, the dryer's door can be left open or slightly ajar for a short period of time if possible to help ventilate the drum after use.

⚠ WARNING

- For safety reasons, do not allow children or animals to enter the appliance. It may cause damage or injury.

NOTE

- The final part of a tumble dry cycle occurs without heat (cool down cycle) to ensure that the clothes are left at a temperature that ensures the clothes will not be damaged.
- A high atmospheric temperature and a small room may both increase drying time as well as energy consumption.

Preparing the Clothes

NOTE

- For the best drying performance and most efficient energy usage, do not overload the appliance.

Checking the Clothes before Loading

⚠ CAUTION

- Check that the clothes are not stuck between appliance and door, or the clothes may get damaged while drying.
- Observe the maximum load capacity on the programme table for the relevant drying programme to get optimum drying results. Overloading gives a poor drying result and causes unnecessary creasing.
- Do not load soaking wet clothes into the appliance. Doing so will increase the drying time and energy consumption. Make sure that the clothes are spun thoroughly in the washer before loading them in the dryer.
- A mixed fabric load can cause the drying time to be extended and the time remaining in the display to pause during active drying until the

actual time remaining matches the time displayed.

- Make sure to empty all pockets. Items such as nails, hair clips, matches, pens, coins and keys can damage both your appliance and clothes.
- Remove loose belts and close zippers, hooks and strings to make sure that these items do not snag other clothes.

Sorting the Clothes

Clothes have their own fabric care labels, so drying according to the fabric care label is recommended. Sort the clothes into size and type of fabric and then prepare the clothes according to the symbols on the fabric care labels.

Woollens

- Dry woollens on the **Wool Refresh** programme. Be sure to follow fabric care label symbols first. Wool may not be completely dried from the cycle, so do not repeat drying. Pull woollens to their original shape and dry them flat.

Woven and Loopknit Materials

- Some woven and loopknit materials may shrink, depending on quality.

No-Iron and Synthetics

- Do not overload the appliance. Take out no-iron items as soon as the appliance stops to reduce creases.

Baby Clothes and Nightgowns

- Always check fabric care labels.

Rubber and Plastics















- Do not dry any items made from or containing rubber or plastics such as:
 - Aprons, Bibs and Chair Covers
 - Curtains and Tablecloths
 - Bath Mats

Fiberglass

- Do not dry fiberglass items in the appliance. Glass particles left in the appliance may be subsequently picked up by your clothes in later cycles.

Checking the Fabric Care Label

The symbols on the fabric care label tell you about the fabric content of your clothes and how they should be dried.

Symbol	Description
	Dry
	Tumble Dry
	Permanent Press / Crease Resistant
	Gentle / Delicate
	Do not Tumble Dry
	Do not Dry
	High Heat
	Medium Heat
	Low Heat
	No Heat / Air
	Line Dry / Hang to dry
	Drip Dry
	Dry Flat
	In the Shade





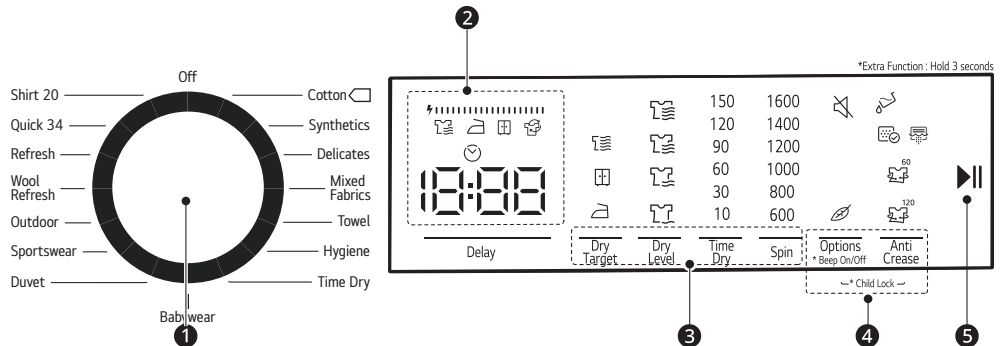











Control Panel

Control Panel Features



	Description
①	<p>Programme Selector</p> <ul style="list-style-type: none"> Programmes are available according to the clothing type. The lamp will light up to indicate the selected programme.
②	<p>Time and Status Display</p> <ul style="list-style-type: none"> The display shows the settings, estimated remaining time, options, and status messages. When the appliance is turned on, the default settings in the display will illuminate.
③	<p>Customizing Drying Programme Buttons</p> <ul style="list-style-type: none"> Use these buttons to adjust the dry level or spin speed settings for the selected programme. The current settings are shown in the display.
④	<p>Extra Options and Functions / Additional Programme Buttons</p> <ul style="list-style-type: none"> Use these buttons to select the desired options for the selected programme. Not all options are available in each programme.
⑤	<p>Start/Pause Button</p> <ul style="list-style-type: none"> This Start/Pause button is used to start or pause a dry cycle. When in pause, the power is turned off automatically after a certain time for safety reasons.

Display symbols

symbols	Description	symbols	Description
	Water tank warning indicator		Anti-crease 60'
	Lint filter cleaning warning indicator		Anti-crease 120'
	Heat exchanger cleaning warning indicator		Delicate
	Extra Dry		Beep On/Off
	Cupboard Dry		Delay
	Iron Dry		
	Drying level 1	<p>Energy Consumption Display The energy consumption display shows the energy consumption of the selected program. The bigger the display, the more the energy consumption. The energy consumption level increases or decreases depending on the fabric type, duration of the selected program, the drying level and the spinning speed.</p>	
	Drying level 2		
	Drying level 3		
	Drying level 4		

Programme Table

Drying programme Guide

Programme	Cotton <input type="checkbox"/>	Max. Load Capacity	8 kg
Detail	This programme dries cotton laundry including bedsheets, pillowcases, pyjamas, underwear, tablecloths etc.		

Programme	Synthetics	Max. Load Capacity	4 kg
Detail	This programme dries synthetics, such as shirts, t-shirts, blouses, at a lower temperature compared to the cottons programme.		

Programme	Delicates	Max. Load Capacity	2kg
Detail	This programme dries thin clothes like shirts, blouses and silk garments at a low temperature to make them ready to wear.		

Programme	Mixed Fabrics	Max. Load Capacity	4 kg
Detail	This programme dries cotton-synthetic mixed garments that do not discolour to make them ready to wear.		

Programme	Towel	Max. Load Capacity	3 kg
Detail	This programme dries thick cotton laundry such as towels, bathrobe, etc.		

Programme	Hygiene	Max. Load Capacity	3 kg
Detail	This programme is suitable for the fabrics which need hygiene requirements.		

Programme	Time Dry	Max. Load Capacity	-
Detail	To reach the required drying level at a low temperature, you can use the time programmes of 10 min. to 150 min. Regardless of the drying level, the programme stops at the desired time.		

Programme	Babywear	Max. Load Capacity	3 kg
Detail	This programme provides hygienic drying for delicate infant clothes at a low temperature.		

Programme	Duvet	Max. Load Capacity	2.5 kg
Detail	This programme is used to dry single duvet with feather, down or synthetic fillings.		

20 OPERATION

Programme	Sportswear	Max. Load Capacity	4 kg
Detail	Sport program is used for synthetic sport laundries like shorts, t-shirts at low temperature.		

Programme	Outdoor	Max. Load Capacity	2 kg
Detail	This programme is suitable for outdoor clothing, waterproof jackets, jackets with inner insulation, etc.		

Programme	Wool Refresh	Max. Load Capacity	-
Detail	Wool refresh helps wool textiles to remove excess water after washing by applying low temperature and gentle movements of drum.		

Programme	Refresh	Max. Load Capacity	-
Detail	Time drying option is selected from 10 minutes to 150 minutes without providing hot air, refresh is done and bad odors can be eliminated.		

Programme	Quick 34	Max. Load Capacity	1 kg
Detail	1 kg of synthetics spun at a high speed in the washing machine are dried in 34 minutes.		

Programme	Shirt 20	Max. Load Capacity	0.5 kg
Detail	2 to 3 shirts are ready for to be ironed in 20 minutes.		

NOTE

- Stand By Mode
 - After 15 minutes without user's action in selection mode, the appliance goes to Stand By mode to decrease energy consumption. In this mode, --- must blink with 0.5 sec ON, 3 sec OFF. At the Stand By mode, --- led luminosity is reduced. To restart the appliance, it will be necessary to move selector to Off and select a programme.

Selectable Drying Options

*1 This option is automatically inserted in the programme and can not be deselected.

NOTE

- **Delay**, **Child Lock** and **Anti Crease** options can be selected for every drying programme in this table.
-

Programme	Dry Target	Delicate	Time Dry	Dry Level	Spin
Cotton	●	●		●	●
Synthetics	●	●		●	●
Delicates	●	●*1			●
Mixed Fabrics	●	●		●	●
Towel	●	●		●	●
Hygiene	●	●		●	●
Time Dry			●		
Babywear	●	●		●	●
Duvet	●	●		●	●
Sportswear	●	●		●	●
Outdoor	●	●		●	●
Wool Refresh					
Refresh			●		
Quick 34	●				
Shirt 20	●				

Extra Options and Functions

Dry Target

It allows you to select a dry target for the drying programme.

- **Extra:** For thick and quilted fabrics
- **Cupboard:** For fabrics that do not need to be ironed
- **Iron:** For fabrics that need to be ironed

- 1 Select a programme.
- 2 Select a dry target by pressing the **Dry Target** button repeatedly.

Dry Level

The dampness level obtained after drying can be increased by another 3 levels in addition to the standard setting.

This way, it is ensured that the laundry is drier.

- 1 Select a programme.
- 2 Select a dry target by pressing the **Dry Level** button repeatedly.

Time Dry

It allows you to increase or decrease drying time when you use manual drying programmes such as **Time Dry** and **Refresh**.

- Select drying time by pressing the **Time Dry** button repeatedly.

Spin

For the laundry to be dried, set the spin speed on the washing machine where you washed the laundry.

This way, it is ensured that the estimated drying time is more accurately displayed.

Delay

It allows you to delay the starting time of the drying cycle from 1 hours to 23 hours.

- 1 Select a programme.
- 2 Press the **Delay** button.
- 3 Set time delay hour(s) by pressing the **Delay** button.
- 4 Press the **Start/Pause** button.

NOTE

- If you long press the **Delay** button, the delay time will change continuously.
-

Beep On/Off

It allows you to turn the chime sound on and off. Press and hold the **Options** button for 3 seconds at the same time.

- The LED lights up when the option is turned on.

Delicate

Delicate fabrics are dried in a longer time at low temperatures.

- 1 Select a programme.
- 2 Press the **Options** button.
- 3 Press the **Start/Pause** button.

Anti Crease

It allows you to reduce creases that are formed when the clothes are not unloaded promptly at the end of drying cycle.

If you do not open the door of the machine at the end of the program, the anti-crease option will be active for 60 minutes. When the **Anti Crease** option is selected, **Anti Crease** will be active for 120 minutes.

To turn off the option, press the **Anti Crease** button before you start a drying cycle.

Child Lock

It allows you to control the locking and unlocking of control panel. It prevents children from changing cycles or operating the appliance.

Locking the Control Panel

- 1 Press and hold the **Options** and **Anti Crease** button simultaneously for 3 seconds.
- 2 A chime will sound, and **CL** will appear on the display.
 - When the function is activated, all buttons are locked.

Unlocking the Control Panel

Press and hold the **Options** and **Anti Crease** button simultaneously for 3 seconds.

- A chime will sound and the remaining time for the current programme will reappear on the display.

NOTE

- **Child Lock** is not automatically deactivated at the end of the programme. In case that programme ended with **Child Lock** status at previous use, you should unlock control panel after turning on the appliance to operate control panel and start a programme.

MAINTENANCE

⚠ WARNING

- Remove the power plug when you clean the appliance. Not removing the plug may result in electric shock.

Cleaning after Every Dry

Cleaning the Lint Filter

⚠ CAUTION

- Clean the lint filter in the proper way referring to the following instructions. Failure to do so, the lint that is accumulated on the heat exchanger may not be cleaned properly.

NOTE

- Unload the all of the laundries from the appliance before pull out the lint filter.
- After cleaning the lint filter insert them in a place. If the lint filter is not in the appliance, you can not operate the appliance.

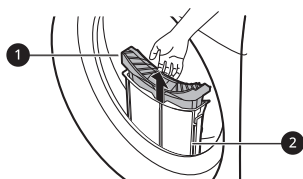

① Inner Filter

- Always clean the inner filter before and after use.

② Outer Filter

- Clean the outer filter after drying 10 times or when the lint is accumulated into the outer filter.

Clean the inner filter

- Pull out the inner filter from the outer filter and then open the inner filter.
 - Open the filter by unfolding it in the direction of the arrow.

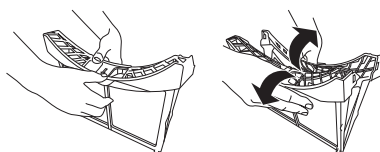

- Clean a large cluster of lint first, then clean the residual lint using vacuum cleaner or washing under running water.

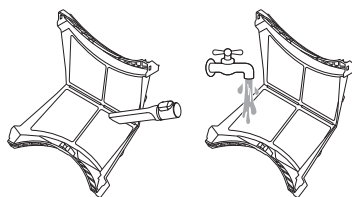

- Dry the filter completely if the filter is moist. Failure to do so, odour may occur in the appliance.

- After drying the inner filter completely, close the filter by pushing down its center.
 - Ensure the left and right side of the inner filter is closed properly.

- Insert the inner filter into the outer filter.

Clean the outer filter

- 1 Remove the dust or lint around the filter inlet.

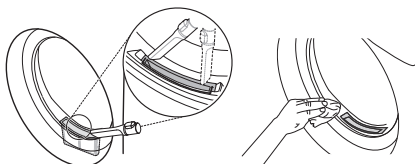

⚠ CAUTION

- When the lint drops into the filter inlet, it may cause degradation of drying performance and increase in drying time.

- 2 Pull out the outer filter.

- 3 Remove the inner filter.

- 4 Open the outer filter by unfolding in the direction of the arrow grasping the top edge of the outer filter.

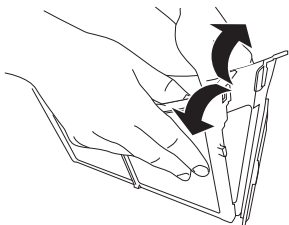

- 5 Clean the residual lint using vacuum cleaner or washing under running water.

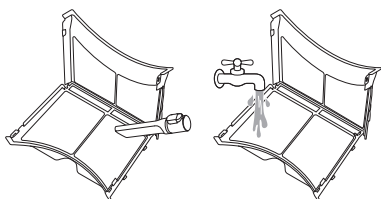

- Dry the filter completely if the filter is moist. Failure to do so, odour may occur in the appliance.

- 6 Close the outer filter while pushing the side ① of the filter.

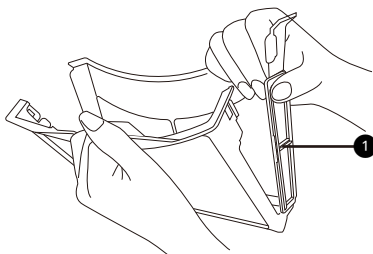

- 7 Close them, and reinsert the both lint filters.

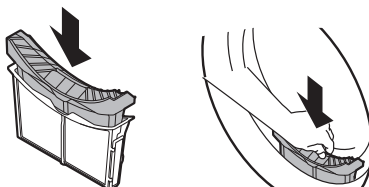

⚠ CAUTION

- Do not load or remove any clothes when the lint filter is not in a place. The clothes can drop into the filter inlet and it may cause the appliance to malfunction.

Emptying the Water Container

Condensed water is collected in the water container.

Empty the water container after every use. Not doing so will affect the drying performance.

NOTE

- If the water container is full, the  icon glows and a chime will sound while the appliance is operating. If this should occur, the water container needs to be emptied within the next hour.
- When the condensed water is drained out directly through the optional drain hose, there is no need to empty the water container.

- 1 Pull out the water container.

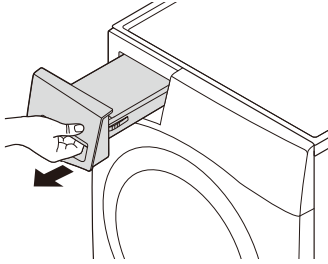

- 2 Empty the water container into the sink.

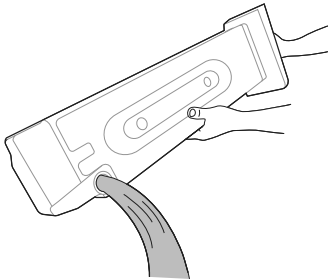

⚠ CAUTION

- Do not drink the condensed water or reuse it. It could lead to health problems for people and animals.

- 3 Refit it back into the appliance.
 - Push in the water container fully into the appliance until it is in place.
- 4 Press the **Start/Pause** button.

Cleaning the Appliance Periodically

Cleaning The Heat Exchanger

Clean the heat exchanger when the  lights up .

Clean the heat exchanger after 30 drying cycles or 3 times a month even if  is not lights up.

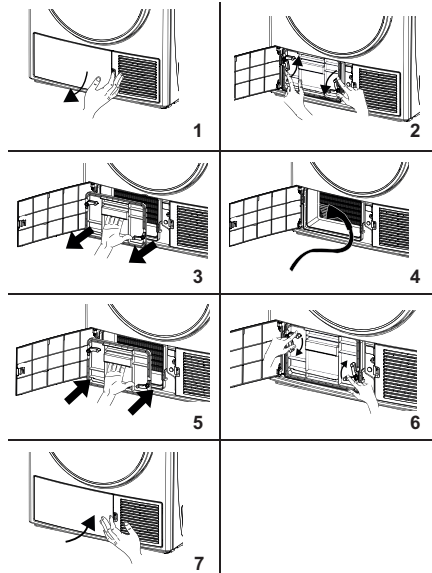

- 1 Open the kick plate cover as shown.
- 2 Unlock the exchanger cover by turning in the direction shown with arrows.
- 3 Take out the exchanger cover as shown.
- 4 Clean the front surface of the exchanger as shown.
- 5 Fit the exchanger cover as shown.
- 6 Lock the exchanger cover by turning in the direction shown with arrows.
- 7 Close the kick plate cover as shown.

Wiping the Moisture Sensor

This device senses the moisture level of the clothes during operation, which means it must be cleaned regularly to remove any build-up of lime scale on the surface of the sensor.

Wipe the sensors inside the drum.

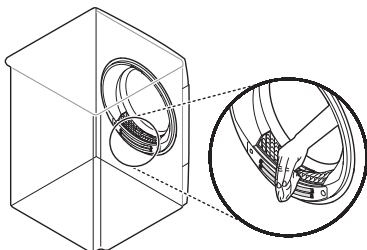

⚠ CAUTION

- Do not wipe the moisture sensor with abrasive materials. Always clean the sensor with a dry rough acrylic sponge.

TROUBLESHOOTING

Errors and malfunctions may occur when operating the appliance. The following tables contain possible causes and notes for resolving an error message or malfunction. Read the tables below carefully in order to save time and money before calling the LG Electronics service centre.

Before Calling for Service

Your appliance is equipped with an automatic error-monitoring system to detect and diagnose problems at an early stage. If the appliance does not function properly or does not function at all, check the following tables before calling to LG Electronics service centre.

Error Messages

Symptoms	Possible Cause & Solution
E00	Contact the nearest authorised service agent.
E03	Empty the water tank, if problem does not solved, contact the nearest authorised service agent.
E04	Contact the nearest authorised service agent.
E05	Contact the nearest authorised service agent.
E06	Contact the nearest authorised service agent.
E07	Contact the nearest authorised service agent.
E08	There may be voltage fluctuation in mains. Wait until voltage is appropriate for working range.

Operation

Symptoms	Possible Cause & Solution
Appliance will not turn on.	Power cord is not properly plugged in. <ul style="list-style-type: none"> Make sure that the power plug is securely plugged into a grounded outlet matching the appliance's rating plate.
	House fuse is blown, circuit breaker has tripped, or power outage has occurred. <ul style="list-style-type: none"> Reset circuit breaker or replace fuse. Do not increase fuse capacity. If the problem is a circuit overload, have it corrected by a qualified electrician.

Symptoms	Possible Cause & Solution
Appliance does not heat.	<p>House fuse is blown, circuit breaker has tripped, or power outage has occurred.</p> <ul style="list-style-type: none"> Reset circuit breaker or replace fuse. Do not increase fuse capacity. If the problem is a circuit overload, have it corrected by a qualified electrician.
Water leaks.	<p>The water container hose or the optional drain hose is not connected correctly.</p> <ul style="list-style-type: none"> Connect the water container hose or the optional drain hose correctly.
	<p>The door is closed while clothes or foreign substance is caught in the door.</p> <ul style="list-style-type: none"> Check if clothes or foreign substance is caught in the door before using the appliance. If water leaks continuously, contact the LG Electronics Customer Information Centre.
Appliance runs and pauses by itself after the drying cycle finishes.	<p>This is how the anti crease option works.</p> <ul style="list-style-type: none"> Make sure that the anti crease option has been set. The option is designed to prevent creases that are formed when the clothes are not unloaded promptly after the drying cycle. When the option is set, the appliance runs for 10 seconds and pauses for 5 minutes. The option is works for up to 2 hours.

Performance

Symptoms	Possible Cause & Solution
Clothes take too long to dry.	<p>Load is not properly sorted.</p> <ul style="list-style-type: none"> Separate heavy items from lightweight items. Larger and heavier items take longer to dry. Light items in a load with heavy items can fool the sensor because the light items dry faster.
	<p>Large load of heavy fabrics.</p> <ul style="list-style-type: none"> Heavy fabrics take longer to dry because they tend to retain more moisture. To help reduce and maintain more consistent drying times for large and heavy fabrics, separate these items into smaller loads of a consistent size.
	<p>Appliance controls are not set properly.</p> <ul style="list-style-type: none"> Use the appropriate control settings for the type of load you are drying. Some loads may require an adjustment of the dry level setting for proper drying.
	<p>Lint filter needs to be cleaned.</p> <ul style="list-style-type: none"> Remove the lint from the lint filter after every cycle. With the lint removed, hold the lint filter up to a light to see if it is dirty or clogged. With some loads that produce high amounts of lint, such as new bath towels, it may be necessary to pause the cycle and clean the filter during the cycle.

Symptoms	Possible Cause & Solution
Clothes take too long to dry.	House fuse is blown, circuit breaker has tripped, or power outage has occurred. <ul style="list-style-type: none"> Reset circuit breaker or replace fuse. Do not increase fuse capacity. If the problem is a circuit overload, have it corrected by a qualified electrician.
	Appliance is overloaded. <ul style="list-style-type: none"> Divide extra large loads into smaller loads for better drying performance and efficiency.
	Appliance is underloaded. <ul style="list-style-type: none"> If you are drying a very small load, add a few extra items to ensure proper tumbling action. If the load is very small and you are using Sensor Dry programmes, the electronic control cannot properly sense the dryness of the load and may shut off too soon. Use Timed Drying programmes or add some extra wet clothes to the load.
Drying time is not consistent.	Heat settings, load size, or dampness of clothing is not consistent. <ul style="list-style-type: none"> The drying time for a load will vary depending on the type of heat used (electric), the size of the load, the type of fabrics, the wetness of the clothes, and lint filter. Even an unbalanced load in the appliance can cause poor spinning, resulting in wetter clothes which will take longer to dry.
Greasy or dirty spots are left on clothes.	Fabric softener is used incorrectly. <ul style="list-style-type: none"> When washing clothes that are to be dried in the appliance, use the correct amount of fabric softener as recommended by the manufacturer of the fabric softener.
	Clean and dirty clothes are being dried together. <ul style="list-style-type: none"> Use the appliance to dry only clean items. Soil from dirty clothes can transfer to the clean clothes in the same or later loads.
	Clothes were not properly cleaned or rinsed before being placed in the appliance. <ul style="list-style-type: none"> Stains on dried clothes could be stains that were not removed during the washing process. Make sure that clothes are being completely cleaned or rinsed according to the instructions for your washing machine and detergent. Some difficult soils may require pre-treating prior to washing.
Clothes are wrinkled.	Clothes have dried too long (overdried). <ul style="list-style-type: none"> Over drying a load of clothes can lead to wrinkled clothes. Try a shorter drying time.
	Clothes have been left in the appliance for too long after cycle ends. <ul style="list-style-type: none"> Use the Anti Crease option.
Clothes are shrinking.	Garment care instructions are not being followed. <ul style="list-style-type: none"> To avoid shrinking your clothes, always consult and follow fabric care instructions. Some fabrics will naturally shrink when washed. Other fabrics can be washed but will shrink when dried in the appliance. Use a low or no heat setting.

Symptoms	Possible Cause & Solution
Lint is left on clothes.	Lint filter has not been cleaned properly. <ul style="list-style-type: none"> Remove the lint from the lint filter after every cycle. With the lint removed, hold the lint filter up to a light to see if it is dirty or clogged. If it looks dirty, follow the cleaning instructions. With some loads that produce high amounts of lint, it may be necessary to clean the lint filter during the cycle.
	Clothes have not been sorted properly. <ul style="list-style-type: none"> Some fabrics are lint producers (i.e., a fuzzy white cotton towel) and should be dried separately from clothes that are lint trappers (i.e., a pair of black linen pants).
	Appliance is overloaded. <ul style="list-style-type: none"> Divide extra large loads into smaller loads for drying.
	Tissue, paper, etc., has been left in pockets. <ul style="list-style-type: none"> Check pockets thoroughly before drying clothes.
Excess static in clothes after drying.	Clothes have dried for too long (overdried). <ul style="list-style-type: none"> Overdrying a load of clothes can cause a buildup of static electricity. Adjust settings and use a shorter drying time, or use Sensor Dry programmes.
	Drying synthetics, permanent press, or synthetic blends. <ul style="list-style-type: none"> These fabrics are naturally more prone to static buildup. Try using fabric softener, or use shorter Timed Drying time settings.
Clothes have damp spots after a Sensor Dry programme.	Very large load or very small load. Single large item such as a blanket or comforter. <ul style="list-style-type: none"> If items are too tightly packed or too sparse the sensor may have trouble reading the dryness level of the load. Use a Timed Drying programme for very small loads. Large, bulky items such as blankets or comforters can sometimes wrap themselves into a tight ball of fabric. The outside layers will dry and register on the sensors, while the inner core remains damp. When drying a single bulky item, it may help to pause the cycle once or twice and rearrange the item to unwrap and expose any damp areas. To dry a few remaining damp items from a very large load or a few damp spots on a large item after a Sensor Dry programme has completed, empty the lint filter, then set a Timed Drying programme to finish drying the item(s).

Odours

Symptoms	Possible Cause & Solution
<p>The appliance has an odour.</p>	<p>Are you using the appliance for the first time?</p> <ul style="list-style-type: none"> • The smell is caused by rubber material that is attached to the appliance inside. This kind of smell is a rubber's own smell and disappears automatically after using the appliance several times.
	<p>Do you smell an odour during use?</p> <ul style="list-style-type: none"> • When washing the clothes, use the detergent in accordance with the manufacturers recommendations. If you use the detergent excessively not according to the recommendations, undissolved detergent may accumulate on the clothes and cause an odour. • You can smell odours from the clothes if the clothes were left in the appliance after drying or in the washing machine after washing. Unload the clothes promptly at the end of the drying or washing cycle. • Ensure you can smell same odour in the washing machine. If so, clean the tub of the washing machine referring to the washing machine user manual. • Always take care of both lint filters clean. If any residues were left in the lint filter after drying, it may cause odours. And also dry the lint filter completely after cleaning.

Memo

Memo

Memo

