



Scan the QR code to see the manual.



OWNER'S MANUAL

BUILT-IN OVEN



Before beginning installation, read these instructions carefully. This will simplify installation and ensure that the product is installed correctly and safely. Leave these instructions near the product after installation for future reference.

ENGLISH

WSEZM7225S2

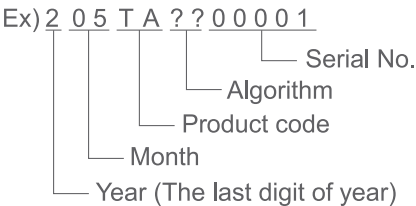

MFL62060358
Rev.07_051226



www.lg.com

TABLE OF CONTENTS

This manual may contain images or content that may be different from the model you purchased.
This manual is subject to revision by the manufacturer.

IMPORTANT SAFETY INSTRUCTIONS

- READ ALL INSTRUCTIONS BEFORE USE 4**
 - Safety Messages.....4
- WARNING 5**
 - Installation5
 - Damage5
 - Maintenance6
 - Operation7
- CAUTION..... 10**
 - Operation10
 - Maintenance10
- CARING FOR THE ENVIRONMENT 11**
 - Used Appliances11

PRODUCT OVERVIEW

- Product Features 12**
 - Accessories.....12
 - Product Specifications12

INSTALLATION

- Before Installing..... 13**
 - Proper Location and Dimensions.....13
 - Parts / Tools14
- Installing the Oven 14**
 - Instructions.....14

OPERATION

- Operating Control Panel 16**
 - Control Panel Features16
 - Energy Saving Tips16
- Changing Settings 17**
 - Clock.....17
 - Cooking with Oven.....18

Quick Preheat	18
Setting Overall Cooking and Baking Time	18
Timer	18
Child-Proof Lock	19
Operating the Oven	19
Before Using the Oven	19
Locking Function	19
Selecting Cooking Modes	20
Cooking with ECO Mode	22
Recommended Baking Guide	23
Recommended Roasting Guide	25
Test Food According to EN 60350-1	26

MAINTENANCE

Cleaning	28
General Cleaning Tips	28
Exterior	28
Interior	29
Periodic Maintenance	29
Changing the Oven Light	29
Removing and Assembling the Oven Door	30
Removing the Door Cover	31
Changing the Power Cord	32
Removing Rails	33
Removing and Assembling the Telescopic Runners	33
Removing and Assembling the Self-cleaning Baffle	34

TROUBLESHOOTING

FAQs	36
Frequently Asked Questions	36
Before Calling for Service	37
Cooking	37
Parts & Features	38
Information Mode Power Consumption	39
Customer Service	40

IMPORTANT SAFETY INSTRUCTIONS

READ ALL INSTRUCTIONS BEFORE USE

Safety Messages

Your safety and the safety of others are very important.

We have provided many important safety messages in this manual and on your appliance. Always read and follow all safety messages.

Read and follow instructions when you use the appliance to avoid fire risks, electric shock, bodily injuries or damage. This guide does not include all possible situations that could happen. Always contact your technical service agent or the manufacturer when any incomprehensible problem appears. These instructions are only valid if the country symbol appears on the appliance. If the symbol does not appear on the appliance, it is necessary to refer to the technical instructions which will provide the necessary instructions concerning modification of the appliance to the conditions for use in the country.



This is the safety alert symbol.

This symbol alerts you to potential hazards that can kill or injure you and others. All safety messages will follow the safety alert symbol and either the word **WARNING** or **CAUTION**.

These words mean:



WARNING

You may be killed or seriously injured if you do not follow instructions.



CAUTION

You may be injured or cause damage to the product if you do not follow instructions.

All safety messages will tell you what the potential hazard is, tell you how to reduce the chance of injury, and tell you what may happen if the instructions are not followed.

WARNING

WARNING

- To reduce the risk of explosion, fire, death, electric shock, injury or scalding to persons when using this product, follow basic precautions, including the following:

Installation

- Never allow anyone to climb, sit, stand or hang on the oven door. Injury might result from contact with hot food or the oven itself.
- Do not line the oven walls, racks, bottom, or any other part of the oven with aluminium foil or any other material. Doing so will disrupt heat distribution, produce poor baking results and cause permanent damage to the oven interior (aluminium foil will melt to the interior surface of the oven).
- Do not use aluminium foil or any other material to line the oven bottom. Improper installation of oven liners may result in a risk of electric shock or fire.
- Make sure your appliance is properly installed and grounded by a qualified installer, according to the installation instructions. Any adjustment and service should be performed only by qualified installers or service technicians.
- Be certain that all packing materials are removed from the appliance before operating. Keep plastic, clothes, paper, and other flammable materials away from parts of the appliance that may become hot.
- The electrical power must be shut off while the electrical connections are being made.
- Improper connection of aluminium house wiring to copper leads can result in an electrical hazard or fire. Use only connectors designed for joining copper to aluminium and follow the manufacturer's recommended procedure closely.

Damage

- If the oven has been damaged in transport, do not connect it.

- In the event of a fault or damage to the appliance, do not attempt to operate it.
- Repairs to the appliance should be carried out by a licensed technician only. Wrong repairs may result in considerable danger. If you need repairs, contact an LG Service Centre or your dealer.
- If the supply cord is damaged, it must be replaced by the manufacturer, its service agent or similarly qualified persons in order to avoid a hazard.
- Never remove the outer casing from the oven. If the oven is faulty and needs servicing or you are in doubt about its condition, unplug it from the wall socket and contact the nearest after-sales service centre. Failure to do so can result in malfunctioning and death or electrical shock during use.

Maintenance

- The power supply of the appliance should be turned off when it is being repaired or cleaned.
- Be careful when connecting electrical appliances to sockets near to this appliance.
- Do not use high-pressure water cleaners or steam jet cleaners for electrical safety reasons.
- Do not use harsh abrasive cleaners or sharp metal scrapers to clean the oven door glass since they can scratch the surface, which can result in shattering of the glass.
- Ensure that the appliance is switched off before replacing the lamp to avoid the possibility of electric shock. Failure to do so can result in malfunctioning and death or electrical shock during use.
- Do not use harsh abrasive cleaners or sharp metal scrapers to clean the oven door glass/ the glass of hinged lids of the hob (as appropriate), since they can scratch the surface, which can result in shattering of the glass.
- The oven must be switched off before removing the guard and that, after cleaning, the guard must be reinstalled in accordance with the instructions.

Operation

- Do not touch interior parts until they have cooled down sufficiently. When the oven operates, the interior parts will be very hot and burns may occur.
- Accessible parts can become hot during use. Young children should be kept away.
- The appliance is not intended for use by young children or infirm persons without supervision.
- Young children should be supervised to ensure that they do not play with the appliance.
- Children should be kept at a safe distance when the oven operates.
- Children should be kept at a safe distance until the oven has cooled down after cooking.
- This appliance is not intended for use by persons (including children) with reduced physical, sensory or mental capabilities, or lack of experience and knowledge, unless they have been given supervision or instruction concerning the use of the appliance by a person responsible for their safety.
- The appliance and its accessible parts become hot during use. Care should be taken to avoid touching heating elements. Children less than 8 years of age shall be kept away unless continuously supervised.
- This appliance can be used by children aged from 8 years and above and persons with reduced physical, sensory or mental capabilities or lack of experience and knowledge if they have been given supervision or instruction concerning the use of the appliance in a safe way and they understand the hazards involved. Children shall not play with the appliance. Cleaning and user maintenance shall not be made by children without supervision.
- Never block the air vents. The oven may overheat and automatically switch itself off. It will remain inoperable until it has cooled sufficiently.
- Do not cover or obstruct the ventilation with cloth or paper. The cloth or paper may catch fire as hot air is emitted from the oven.

8 IMPORTANT SAFETY INSTRUCTIONS

- Do not spill or pour water in the vents.
- During use the appliance becomes hot. Care should be taken to avoid touching heating elements inside the oven. These walls may be hot enough to burn skin even after cooking is finished, though they do not appear to be so, avoid placing hands and arms inside the oven.
- The oven surfaces will become hot when the appliance is operated at a high temperature for a long period of time.
- The oven door must be closed while cooking.
- When cooking, take care when opening the oven door as hot air and steam will escape rapidly. The hot air or steam released may cause scalding.
- When cooking dishes that contain alcohol, the alcohol can evaporate due to the high temperatures. The vapour can catch fire if it comes into contact with a hot oven part.
- Never store flammable or easily deformable materials in the oven to reduce the risk of fire in the oven cavity.
- Should an oven fire occur, leave the oven door closed and turn the oven off. If the fire continues, throw baking soda on the fire or use a fire extinguisher. Do not put water or flour on the fire. Flour may be explosive and water can cause a grease fire to spread and cause personal injury.
- Use oven gloves when removing a dish from the oven. The trays and racks are hot.
- The oven must be secured by screwing a minimum of 2 thin general purpose self tapping screws into the 2 upper mounting holes located on the outer side fascias, into the cabinetry. Check if the oven is installed properly.
- Do not store or operate this equipment outdoors. Do not use this product near water (for example, near a kitchen sink, in a wet basement, or near a swimming pool, and the like).
- Be sure all packaging materials are removed from the appliance before operating it.

- Do not use this oven for commercial purposes. This oven has been designed only for the cooking of household foods and for domestic use.
- Do not use the oven door as a rest table for hot items or cookware.
- Never use your appliance for warming or heating the room.
- Do not step, lean, or sit on the door of the oven. These can cause the oven to tip resulting in burns or serious injuries.
- Do not touch an electric cord with a wet hand. It is very dangerous. You can get an electric shock.
- Be careful not to damage the power cable.
- Do not operate this appliance if it has a damaged power cable or plug.
- Do not immerse power cable or plug in water and keep power cable away from heated surfaces.
- Do not let cord hang over the edge of table or counter.
- Please ensure cooking times are correctly set. Over cooking may result in the food catching fire and subsequent damage to your oven.
- Do not pour water on to the oven bottom when it is hot. This could cause damage to the enamel surface and deform the base.
- When cooking very moist cakes, use a deep pan (or baking tray). Dripping fruit juices from the baking tray will leave stains, which become indelible.
- Do not heat unopened food containers. Build-up of pressure may cause the container to burst and result in injury.
- Do not use the oven door as a rest table under any circumstances.
- Be careful when you remove the door. The door is heavy.
- Do not let sparks or open flames come in contact with the appliance when you open the door.
- Always cook with the oven door closed.
- Be careful when you remove or install accessories.
- Remaining fat or food in the appliance can cause fire.
- Do not change the specification of this appliance.

- Do not close or open the oven door by foot excessively.
- Do not use the oven to dry live animals.
- The appliance must not be installed behind a decorative door in order to avoid overheating.

CAUTION

Operation

- Always heat fat slowly, and watch as it heats.
- If frying combinations of oils and fats, stir them together before heating.
- Use a deep fat thermometer, if possible, to prevent overheating fat beyond the smoking point.
- Use the least possible amount of fat for effective shallow or deep-fat frying. Filling the pan with too much fat can cause spillovers when food is added.
- Accessible parts can become hot when the grill is in use.
- When using cooking or roasting bags in the oven, follow the manufacturer's directions.
- The door or the outer surface may get hot when the appliance is operating.
- Do not use this oven for purposes other than cooking.
- Use caution if opening the door when the oven is operating. Hot surfaces can cause serious burns.

Maintenance

- Do not repair or replace any part of the appliance unless specifically recommended in the manual. All other servicing should be performed by a qualified technician.
- Do not use harsh etching, abrasive cleaners or sharp metal scrapers to clean the oven door glass since they can scratch the surface. Scratches can cause the glass to shatter.
- Make sure oven lights are cool before cleaning.

- Do not clean the door gasket. The door gasket is essential for a good seal. Care should be taken not to rub, damage, or move the gasket.
- Do not rinse trays and racks by placing them in water just after cooking. This may cause breakage or damage.
- The oven should be cleaned regularly and any food deposits should be removed. Failure to maintain the oven in a clean condition could lead to deterioration of the surface that could shorten the life of the appliance and possibly result in a hazardous situation.
- Never use oven cleaner in the cooking compartment when it is still warm, and never heat up the oven unless all oven cleaner has been wiped off.
- Do not clean the accessories in a dishwasher.
- Do not use oven cleaners, steam cleaners, harsh chemical cleaners, bleach, vinegar, steel scouring pads, or abrasive pads or cleansers to clean the oven, as they can permanently damage the oven surface.

CARING FOR THE ENVIRONMENT

Used Appliances

CAUTION

- Used appliances must be rendered unusable prior to disposal so that they no longer present a risk. To achieve this, disconnect from the mains supply and remove the power supply cable.

For the protection of the environment, used appliances must be disposed of properly.

- The appliance must not be disposed of along with normal domestic waste.

PRODUCT OVERVIEW

Product Features

The appearance and specifications listed in this manual may vary due to constant product improvements.

Accessories

Accessories for Cooking

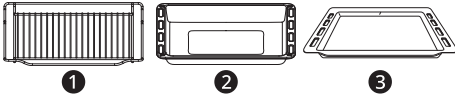

- ① Grill Rack
- ② Deep Tray
- ③ Baking Tray

Accessories for Installation

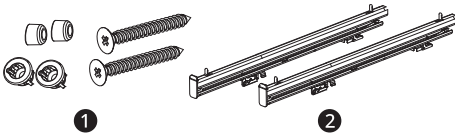

- ① Installation Kit
- ② Telescopic Runner (2 ea)

NOTE

- Contact your LG Electronics customer information center if any accessories are missing for your particular model.
- For your safety and for extended product life, only use authorized components.
- The manufacturer is not responsible for product malfunction or accidents caused by the use of separately purchased, unauthorized components or parts.
- The images in this guide may be different from the actual components and accessories, which are subject to change by the manufacturer without prior notice for product improvement purposes.

Product Specifications

The appearance and specifications listed in this manual may vary due to constant product improvements.

Model	WSEZM7225S2
Description	Electric Built-In Oven
Power Supply	220-240 V~, 50-60 Hz (Saudi Arabia only) 220-240 V~, 50 Hz (except Saudi Arabia)
Max Power Consumption	2900 Watts (2.9 kW)
Interior Dimensions	503 mm (W) x 362 mm (H) x 394 mm (D)
Net Weight	32.6 kg
Capacity	72 L

INSTALLATION

Before Installing

Proper Location and Dimensions

⚠ CAUTION

- The appliance must not be installed behind a decorative door in order to avoid overheating.
- A kitchen cabinet that is in direct contact with the oven must have heat resistance to temperatures up to 90 °C, the front panels of other appliances located near the oven must be heat resistant to a minimum temperature of 70 °C.
- If the supply cord is damaged, it must be replaced by the manufacturer, its service agent or similarly qualified persons in order to avoid a hazard.

NOTE

- This installation must be completed by a qualified installer or technician. Proper installation is the responsibility of the installer and product failure due to improper installation is NOT covered under warranty.
- Make sure the base is level and the front of the cabinet is square. If the cabinet base is not level, the oven glides will tend to slide out when opening the door.

Dimensions and Clearances

Measure the current cutout dimensions and compare them to the cutout dimensions shown below. Little or no cabinet work may be necessary.

SINGLE BUILT-IN OVEN

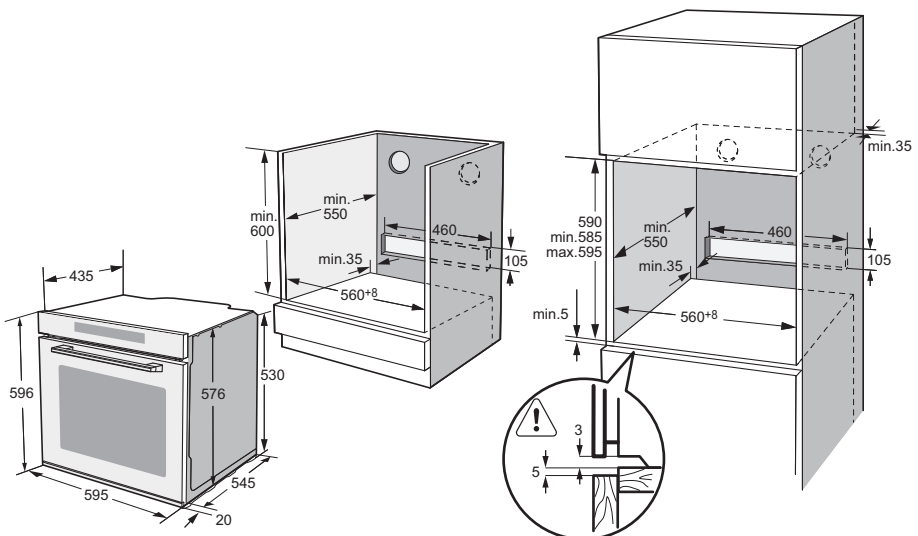

Parts / Tools

⚠ WARNING

- Mounting screws must be used. Failure to do so can result in the oven falling out of the cabinet causing serious injury.

Parts Provided

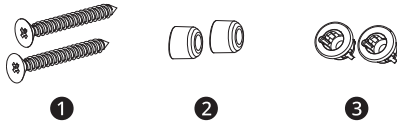

- ① Wood Screw for Mounting (4X25) (2 ea)
- ② Rubber Pad (2 ea)
- ③ Cabinet Screw Mount (2 ea)

Tools Needed

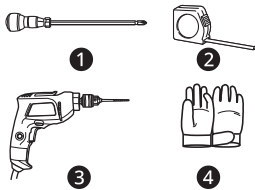

- ① Phillips screwdriver
- ② Tape measure
- ③ Drill
- ④ Gloves

NOTE

- Observe all governing codes and ordinances.
- Have the installer show you the location of the circuit breaker or fuse. Mark it for easy reference.
- As when using any appliance generating heat, there are certain safety precautions you should follow.
- Be sure your appliance is installed and grounded properly by a qualified installer or service technician.

Installing the Oven

Instructions

This oven must only be installed by a licensed electrician. The installer is responsible for the correct electrical connection of the appliances and the observance of the relative safety codes and recommendations.

⚠ WARNING

- The oven should be connected to the electricity supply by means of a proper circuit breaker or fuse. Never use multiple plug adapters or extension leads.
- This connection may be achieved by having the plug accessible or by incorporating a switch in the fixed wiring in accordance with the wiring rules. Failure to do so can result in a fire.

NOTE

- The oven must be installed in compliance with the manufacturer's instructions. For more information about installation, please refer to the installation manual.

Safety Instructions for the Installer

- During installation, ensure that no persons can come into contact with live components.
- The oven must be installed by a qualified professional electrician, in accordance with the corresponding regulations and standards.
- The oven is a heavy appliance and must be transported with great care.
- Before initial use, remove all packaging, both external and from inside the appliance.
- No modification may be made to the oven's technical characteristics.
- To operate this appliance safe, please be sure that it has been installed to a professional standard respecting the installation instructions. Damages occur because of incorrect installation are not within the warranty.
- While doing the installation, please wear protective gloves to prevent yourself from getting cut by sharp edges.

- Check the appliance if there is any damage before installation and do not connect the appliance if there is.
- Before turning on the appliance, please remove all the packaging materials and adhesive film from the appliance.

1 Lift the appliance and place it inside the housing unit.

⚠ CAUTION

- Do not lift the appliance by the door handle to avoid potential damage to the glass and hinges.

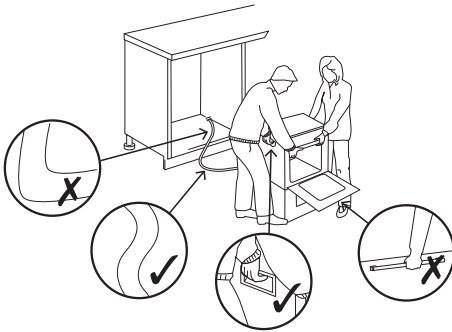

2 Fix the appliance to the housing unit using 2 screws 07a ①. Cover both screws with rubber pads 07b ②.

- Hand-tight only. Do not use power drill to avoid damage to the screw.

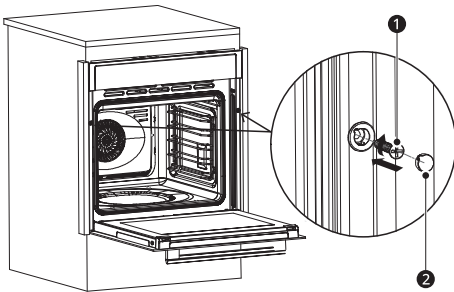

① 07a

② 07b

3 Connect the power plug to an easily reachable electrical outlet so that in case of an emergency the appliance can be unplugged immediately.

- Once the appliance is connected to the electrical outlet, it emits a beep sound and enters standby mode.

4 Pull the power plug out of the electrical outlet to completely switch off the appliance.

OPERATION

Operating Control Panel

Control Panel Features

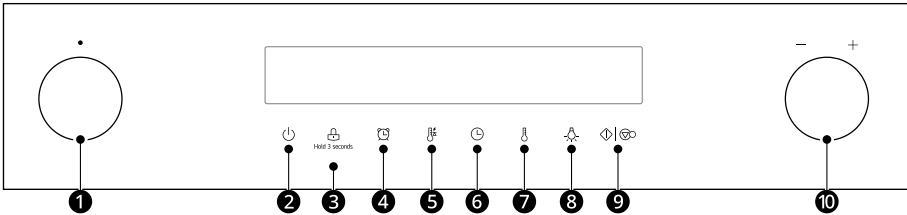

1 Oven Mode Knob

Turn the knob to select oven operating mode. See **Operating the Oven**.

2 On / Off

Press to turn the oven on or off.

3 Child-Proof Lock

Press and hold the button for 3 seconds to activate or deactivate Child-Proof Lock.

4 Timer

Press to set or cancel timer on oven.

5 Quick Preheat

Press to start Quick Preheat mode.

6 Duration

Press to set the overall cooking and/or baking time.

Clock Setting

Press the button then turn the setting knob to set clock in standby mode.

7 Temperature

Press to set temperature of the oven.

8 Light On / Off

Press to turn the oven light on or off.

9 Start / Pause

Press to start or pause the cooking.

10 Setting Knob

Turn the knob to adjust oven settings.

Energy Saving Tips

- Remove all accessories, which are not necessary during the cooking & baking process.

- Do not open the door during the cooking & baking process.
- If you open the door during cooking & baking, switch the mode to “Lamp” (Without change the temperature setting).
- Decrease the temperature setting in not fan assisted modes to 50 °C at 5 minutes to 10 minutes before end of cooking & baking time. So you can use the cavity heat to complete the process.
- Use “Fan Heating”, whenever possible. You can reduce the temperature by 20 °C to 30 °C.
- You can cook and bake using “Fan Heating” on more than one level at the same time.
- If it is not possible to cook and bake different dishes at the same time, you can heat one after the other to use the preheat status of the oven.
- Do not preheat the empty oven, if it is not required. If necessary put the food into the oven immediately after reaching the temperature indicated by switching off the indicator light the first time.
- Do not use reflective foil, like aluminum foil to cover the cavity floor.
- Use the timer and or a temperature probe whenever possible.
- Use dark matt finish and light weighted baking molds and containers. Try not to use heavy accessories with shiny surfaces, like stainless steel or aluminum.

Environment

The packaging is made for protect your new appliance against damages during transport. The materials used are selected carefully and should be recycled. Recycling reduces the use of raw materials and waste. Electrical and electronic appliances often contain valuable materials. Please do not dispose of it with your household waste.

Energy Efficiency According to EN 60350-1

Please note the following information:

- The measurement is carried out in the “ECO” mode to determine the data regarding the forced air mode and the label-class.
- The measurement is carried out in the “Top & Bottom Heating” mode to determine the data regarding the conventional mode.
- During the measurement only the necessary accessory is in the cavity. All other parts have to be removed.
- The oven is installed as described in the installation guide and placed in the middle of the cabinet.
- It is necessary for the measurement to close the door like in the household, even when the cable disturbs the sealing function of the gasket during the measurement. To make sure, that there are no negative effects regarding the disturbed sealing due to the energy data, it is necessary to close the door carefully during the measurement. It is maybe required to use a tool to guarantee the sealing of the gasket like in the household, where no cable disturbs the sealing function.
- The determination of the cavity volume carried out for the usage “Defrost” as described on page 20. To ensure an efficient use of the oven, all accessories including side-racks are removed.

Changing Settings



set.

Clock

Before the oven can be used, the time should be

- 1 After the oven has been electrically connected, press the Clock button  then set the time of day in hours by turning the setting knob.



18 OPERATION

- 2 Press the Clock button  again then set the time in minutes by turning the setting knob.
- 3 Press the Clock button  to finish the setting.

NOTE

- The clock has a 24 hour display.
-

Cooking with Oven

- 1 After the oven has been electrically connected, turn the oven mode knob to select functions, turn the setting knob the set cooking temperature.
- 2 Press the Start / Pause button . The oven starts to heat. If not, oven will back to clock after 10 minutes.
- 3 Press the On / Off button  to cancel at any time.

NOTE

- After temperature setting, press the Clock button  and turn the setting knob to set the cooking duration time.
-

Quick Preheat



Use quick preheat to shorten the preheat time. Select a function, press the Quick Preheat button . The preheat icon flashes in the display. If this function can't quick preheat, a "beep" sounds. Defrosting, fermentation and "ECO" functions cannot be used with quick preheat function.

Quick Preheat icon	
--------------------	---



Setting Overall Cooking and Baking Time

To change the overall cooking / baking time during cooking, follow the steps below.

- 1 Press the Clock button  and turn the setting knob to set the overall cooking / baking time.
- 2 Press the Start / Pause button  to start the cooking process.
- 3 Press the On / Off button  to cancel at any time.

⚠ CAUTION



- After the appliance switched off, it becomes very hot especially inside the cavity. Never touch the interior surfaces of the appliance or the heating elements.
 - Use oven gloves to remove accessories or cookware from the cavity, and allow the appliance to cool down.
 - Keep children at a safe distance at the same time to avoid the injury of burns.
-

NOTE

- Changing modes/temperature/rest cooking time may have some negative influences for the result of cooking. It is recommended not to do so unless you are well experienced on cooking.
 - To change the heating type and temperature during cooking, turn the oven mode knob or setting knob at any time. If no other actions are taken within 6 seconds of changing settings, the oven starts to heat with new setting.
-



Timer

The timer can be set before and during cooking process. The timer is not available when function and temperature settings are being changed.

- 1 Press the Timer button  to set the timer in hours.
- 2 Press the Timer button  again to set the timer in minutes.
- 3 Press the Timer button  to accept changes.
- 4 When the set time runs out, a “beep” sounds.
- 4 Ensure that the cavity does not contain any leftover packaging, such as polystyrene pellets or wooden piece which may cause risk of fire.
- 5 Wipe the smooth surfaces in the cavity and the door with a soft, wet cloth.
- 6 To remove the new-appliance smell, heat up the appliance when empty and with the oven door closed.

Child-Proof Lock

Child-Proof Lock is to help prevent children from accidentally turning on the oven or change any settings. Child-Proof Lock is available at any time when the oven is in use or not in use.

- 1 Press the Child-Proof Lock button  for 3 seconds to activate. Child-proof lock icon  appears in the display.
- 2 Press the Child-Proof Lock button  again for 3 seconds to deactivate.
- 7 Keep the kitchen highly ventilated while the appliance is heating up first time. Keep children and pets out of the kitchen during this time. Close the door to the adjacent rooms.
- 8 Adjust the settings indicated. You can find out how to set the heating type and the temperature in the next section.

NOTE

- The maximum operating time of the oven is 9 hours to prevent overheating.

Operating the Oven

Before Using the Oven

Before using the oven to prepare food for the first time, you must clean the cavity and accessories.

- 1 Remove all stickers, surface protection foils and transport protection parts.
- 2 Remove all accessories and the side-racks from the cavity.
- 3 Clean the accessories and the side-racks thoroughly using soapy water and a dish cloth or soft brush.

After the appliance has cooled down:

- 1 Clean the smooth surfaces and the door with soapy water and a dish cloth.
- 2 Dry all surfaces.
- 3 Install the side-racks.

Locking Function

The accessories can be pulled out approximately halfway until they lock in place. The locking function prevents the accessories from tilting when they are pulled out. The accessories must be

20 OPERATION

inserted into the cavity correctly for the tilt protection to work properly.

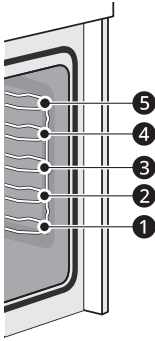

Using the Wire Rack

When inserting the wire rack, ensure the wire rack is onto the right facing direction like the picture.

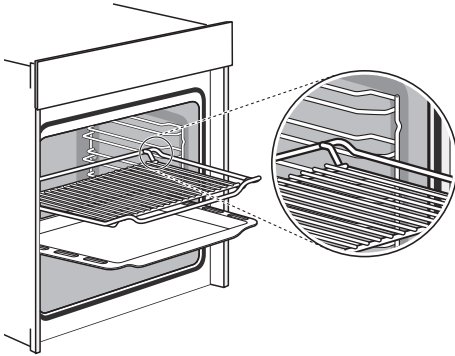

Using the Baking Tray

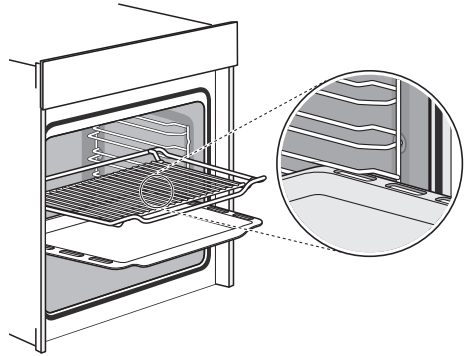

When inserting the backing tray, ensure the backing tray is onto the right facing direction like the picture.











Selecting Cooking Modes

Oven Mode Knob

Turn the Oven Mode Knob to select the desired cooking mode.

Types of Heating		Temperature (°C)		Guide
		Min.	Max.	
	Conventional	30	250	For traditional baking and roasting on one rack. Especially suitable for cakes with moist toppings.
	Convection	50	250	For baking and roasting on one or more racks. Heat comes from the ring heater surrounding the fan evenly.

Types of Heating		Temperature (°C)		Guide
		Min.	Max.	
	ECO	140	240	For energy-saved cooking.
	Conventional + Fan	50	250	For baking and roasting on one or more racks. The fan distributes the heat from the heating elements evenly around the cavity.
	Radiant Heat	150	250	For grilling small amounts of food and for browning food. Please put the food in the center part under the grill heating element.
	Double Grill + Fan	50	250	For grilling flat items and for browning food. The fan distributes the heat evenly around the cavity.
	Double Grill	150	250	For grilling flat items and for browning food.
	Pizza	50	250	For pizza and dishes which need a lot of heat from underneath. The bottom heater and ring heater will work.
	Bottom Heat	30	220	For add extra browning to the bases of pizzas, pies, and pastries. Heating come from the bottom heater.
	Defrost	-	-	For gently defrosting frozen food.
	Fermentation	30	45	For making yeast dough and sour dough to prove and culturing yogurt.

CAUTION

- If you open the appliance door during an on-going operation, the operation will not be paused. Please be especially careful with the risk of burns.
- Do not cover the ventilation slots. Otherwise, the appliance may overheat.
- Use caution if opening the door when the oven is operating. Hot surfaces can cause serious burns.
- After the appliance switched off, it becomes very hot especially inside the cavity. Never touch the interior surfaces of the appliance or the heating elements.
- Use oven gloves to remove accessories or cookware from the cavity, and allow the appliance to cool down.
- Keep children at a safe distance at the same time to avoid the injury of burns.

NOTE







- To defrost big portions of food, it is possible to remove the side-racks and place the container on the cavity floor.
 - To warming tableware, it is beneficial to remove the side-racks and the heating modes Hot Air Grilling and Fan Heating with temperature setting of 50 °C are useful. Hot Air Grilling should be used, if more than half of the cavity floor is covered by the tableware.
 - Due to an optimum evenness of heat distribution inside the cavity during Fan Heating, the fan will work at certain times of the heating process, to guarantee the best possible performance.
 - To make the appliance cools down more quickly after the operation, the cooling fan may continue to run for a period afterwards.
 - It is normal for the fan to operate on and off automatically to circulate the heat evenly within the oven during operation or to cool down the oven after operation.
-

Cooking with ECO Mode













ECO mode uses bottom and ring heater. Use ECO mode to save energy during cooking.

Menu	Accessories	Temperature (°C)	Rack Position	Cooking Time (minutes)	Preheat
Challah	1 tray	180	1	45-50	No
Clafouti Cherry Cake	Round form	200	1	55-60	No
Beef Roast (1.3 kg)	1 tray	200	1	80-85	No
Brownies	Rack and glass plate	180	1	55-60	No
Potato Gratin	Rack and round plate	180	1	65-70	No
Lasagne	Rack and glass plate	180	1	75-80	No
Cheese Cake	Springform Φ20 cm	160	1	80-90	No

Recommended Baking Guide

Menu	Cookware / Baking Shape	Rack Position	Mode	Temperature (°C)	Preheating Time (minutes)	Baking Time (minutes)
Sponge Cake	Square form	2		170	-	50
		1		140	-	70
Sponge Cake with fruits	Round form	1		150	-	50
	Tray	1		140	-	70
Raisins Brioche Muffin (Yeast Cake)	Muffin form	2		220	19	11
Gugelhupf (with Yeast)	Tray	1		150	11	60
Muffin	Muffin form	1		160	8	30
		1		150	8	30
Apple Yeast Cake	Tray	1		160	10	42
		2		150	8	42
Water Sponge Cake (6 Eggs)	Springform	1		160	9	41
Water Sponge Cake (4 Eggs)	Springform	1		160	9	26
Water sponge Cake	Springform	1		160	-	35
Hefezopf (Callah)	Tray	2		150	-	40

24 OPERATION

Menu	Cookware / Baking Shape	Rack Position	Mode	Temperature (°C)	Preheating Time (minutes)	Baking Time (minutes)
Small Cakes (20 ea)	Tray	2		150	-	36
Small Cakes (40 ea)	Tray	2+4		150	10	34
Butter Yeast Cake	Tray	2		150	8	30
Shortbread	Tray	2		170	8	13
Shortbread (2 trays)	Tray	2+4		160	8	12
Vanilla Cookies	Tray	2		160	8	10
		2+4		150	8	14
White Bread (1 kg flour)	Box	1		170	9	50
				170	12	45
Fresh Pizza (thin)	Tray	2		170	9	21
Fresh Pizza (thick)	Tray	2		170	10	45
Fresh Pizza (thick)	Tray	2		170	8	41
Bread	Tray	1		190	9	30

Tips for baking

Do you want to cook your own recipe?

Try to use settings of similar recipes first and optimize the cooking process due to the result.

Is the cake baked ready?

Put a wooden stick inside the cake about 10 minutes before the given baking time is reached. If there is no raw dough at the stick after pulling out, the cake is ready.

The cake loses massive volume during cooling down after baking.

Try to lower the temperature setting by 10 °C and double check the food preparing instructions regarding the mechanical handling of the dough.

The height of the cake is in the middle much higher than at the outer ring.

Do not grease the outer ring of the Springform form.

The cake is too brown at the top.

Use a lower shelf rack and or use a lower set temperature (this may lead to a longer cooking time).

The cake is too dry.

Use a 10 °C higher set temperature (this may lead to a shorter cooking time).

The food is good looking but the humidity inside is too high.

Use a 10 °C lower set temperature (this may lead to a longer cooking time) and double check the recipe.

The browning is uneven.

Use a 10 °C lower set temperature (this may lead to a longer cooking time). Use the "Top & Bottom Heating" mode on one rack.

The cake is less browned on the bottom.

Choose a rack down.

Baking on more than one rack at the same time: One rack is darker than the other.

Use a fan assisted mode for baking on more than one rack and take out the trays individually when ready. It is not necessary that all trays are ready at the same time.



Condensing water during baking.

Steam is part of baking and cooking and moves normally out of the oven together with the cooling air flow. This steam may condensate at different surfaces at the oven or near to the oven and build water droplets. This is a physical process and cannot be avoid completely.



Which kind of cookware can be used?

Every heat resistant cookware can be used. It is recommended not to use aluminium in direct contact with food, especially when it is sour. Please ensure a good fitting between container and lid.

Recommended Roasting Guide

Menu	Cookware	Rack Position	Mode	Temperature (°C)	Roasting Time (minutes)
Beef Tender Loin (1.6 kg)	Tray	2		180	55
Meatloaf (1 kg)	Tray	1		180	75
Chicken (1 kg)	Tray	Rack at 2 Tray at 1		180	50

26 OPERATION

Menu	Cookware	Rack Position	Mode	Temperature (°C)	Roasting Time (minutes)
Chicken (1.7 kg)	Tray	Rack at 2 Tray at 1		180	78
Fish (2.5 kg)	Tray	2		170	70
Ribs Tomahawk Cooked B.T.	Tray	3		120	85

Tips for roasting

How to use the grill function?

Preheat the oven for 5 minutes and place the food in the rack given by this manual. Close the oven door when you use any grilling mode. Do not use the oven when the door is open, except for load / remove / check the food.

How to keep clean the oven during grilling?

Use the tray filled with 2 L of water in at rack position 1. Nearly all fluids drip down from the food placed on the rack will captured by the tray.

The heating element in all grilling modes are switching on and off over the time.



It is a normal operation and depends on the temperature setting.









What happens if a fluid is poured to a food in the oven during the baking or cooking process?

The fluid will boil and steam will arise as a normal physical process. Please be careful, because the steam is hot.

See also "Condensing water during baking" for more information. If the fluid contains alcohol, the boiling process will be quicker and can lead to flames in the cavity. Make sure that the oven door is closed during such kind of processes. Please control the baking or cooking process carefully. Open the door very gentle and only if necessary.

Test Food According to EN 60350-1

Menu	Accessories / Cookware	Mode	Temperature (°C)	Rack Position	Preheat	Cooking Time (minutes)
Sponge Cake	Springform Φ26 cm		175	2	Yes	30-35
			160			

Menu	Accessories / Cookware	Mode	Temperature (°C)	Rack Position	Preheat	Cooking Time (minutes)
Small Cake	1 tray		160	3	Yes	25-30
	1 tray			4		
	2 trays		170	2 + 4		20-25
Apple Pie	Springform Φ20 cm		180	1	No	70-80
			160	2		
Bread	1 tray		200	2	Yes	30-35
			200	3		
Toast	Rack		Max.	5	Yes 5 minutes	1-3
Chicken	Rack & Tray		180	Rack at 2 Tray at 1	Yes	50-60

- In chicken recipe, begin with the backside on top and turn the chicken after 30 minutes to the topside.
- Use a dark, frosted mold and place it on the rack.
- Take out the trays at the moment, when the food is ready, even when it is not at the end of the given baking time.
- Choose the lower temperature and check after the shortest time, given in the table.
- If using the tray to capture fluids dripping from the food placed on the rack during any grilling mode, the tray should be set to rack position 1 and filled with some water.
- The burger patties should be turned around after $\frac{2}{3}$ of the time.

MAINTENANCE

Cleaning

General Cleaning Tips

- A plastic spatula can be used as a scraper to scrape off any chunks or debris before and during oven cleaning.
- Using the rough side of a non-scratch scouring pad may help to take off burnt-on stains better than a soft sponge or towel.
- Certain non-scratch scrubbing sponges, such as those made of melamine foam, available at your local stores, can also help improve cleaning.

Exterior

Take care and clean the oven to retain its appearance and remain fully functioning for a long time. Apply the cleaner to the soft cloth. Do not spray directly on the oven. For general cleaning, use a cloth with hot soapy water.

CAUTION

- Do not use harsh cleaners or harsh abrasive cleaning materials on the outside of the oven door. Doing so can cause damage.
- Do not use any steel scouring pads, abrasive pads or cleaners as these materials can permanently damage the oven surface.
- Do not use Cleaning agents with a high alcohol content, high-pressure cleaners or steam cleaners.

NOTE

- Cleaning products can be purchased online or from most retailers of appliances or home goods.
- Slight differences in colour on the front of the appliance are caused by the use of different materials, such as glass, plastic and metal.

- Shadows on the door panels, which look like streaks, are caused by reflections made by the interior lighting.

Stainless Steel Surface

- 1 Place a small amount of stainless steel appliance cleaner or polish on a damp cloth or paper towel.
- 2 Clean a small area, rubbing with the grain of the stainless steel if applicable.
- 3 Remove flecks of lime scale, grease, starch and albumin (e.g.egg white) immediately. Corrosion can form under such flecks.
- 4 Dry and buff with a clean, dry paper towel or soft cloth.
- 5 Repeat as necessary.

Plastic Surface

Clean with a dish cloth and then dry with a soft cloth. Do not use glass cleaner or a glass scraper.

Painted Surface

Clean with a dish cloth and then dry with a soft cloth.

Control Panel

Clean with a dish cloth and then dry with a soft cloth. Do not use glass cleaner or a glass scraper.

Door Panel

Clean with a dish cloth and then dry with a soft cloth. Do not use a glass scraper or a stainless steel scouring pad.

Door Handle

Clean with a dish cloth and then dry with a soft cloth. If descaler comes into contact with the door handle, wipe it off immediately. Otherwise, any stains will not be able to be removed.

Door seal

Do not remove door seal. Clean with a dish cloth. Do not scour.

Interior

Wash often with warm, sudsy water and a sponge or soft cloth. Use only mild, non-abrasive soaps or a mild detergent. Keep the areas clean where the door and oven frame touch when closed. Wipe well with a clean cloth. Over time, stains can occur on the surfaces as the result of food particles spattering during cooking. This is normal.

Glass Cover for the Interior Lighting

Clean with a dish cloth and then dry with a soft cloth. If the cooking compartment is heavily soiled, use oven cleaner.

Accessories

Soak and clean with a dish cloth or brush. If there are heavy deposits of dirt, use a stainless steel scouring pad.

Rails

Soak and clean with a dish cloth or brush.

Pull-out System

Clean with a dish cloth or a brush. Do not remove the lubricant while the pull-out rails are pulled out. It is best to clean them when they are pushed in. Do not clean in the dish washer.

Enamel Surfaces

Observe the instructions for the surfaces of the cooking compartment.

NOTE

- Always keep the appliance clean and remove dirt immediately so that stubborn deposits of dirt do not build up.
- Clean the cooking compartment after each use. This will ensure that dirt cannot be baked on.
- Always remove flecks of lime scale, grease, starch and albumin (e.g. egg white) immediately.
- Remove flecks of food with sugar content immediately, if possible, when the fleck is still warm.
- Use suitable cookware for roasting, e.g. a roasting dish.
- Enamel is baked on at very high temperatures. This can cause some slight colour variation. This is normal and does not affect operation. The edges of thin trays cannot be completely enameled. As a result, these edges can be rough. This does not impair the anti-corrosion protection.

Periodic Maintenance

Changing the Oven Light

The oven light is a standard 25-watt, 230 V halogen bulb. The bulb and glass cover can be purchased online or from most retailers of appliances or home goods.

⚠ WARNING

- Make sure that the oven and bulb are cool.
- Disconnect the electrical power to the appliance at the main fuse or circuit breaker panel. Failure to do so can result in severe personal injury, death, or electrical shock.
- Wear gloves while changing the oven light. Glass fragments from broken bulbs can cause risk of injury.
- Gently twist the screwdriver blade while changing the oven light. If you apply force, the glass or oven may crack.

- 1 Unplug the oven or disconnect power.

2 Remove the oven racks.

3 Turn the glass cover counter-clockwise to remove it.

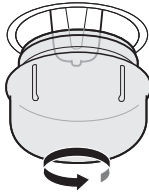

4 Pull out the bulb.

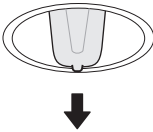

5 Replace the bulb, and reassemble the glass cover by snapping it back into place.

6 Plug in the oven or reconnect power. Switch on the circuit breaker to see if the light turns on.

Glass Cover

If the glass cover of the halogen lamp is damaged, it must be replaced. You can obtain a new glass cover from the after-sales service. Please specify the E number and FD number of your appliance.

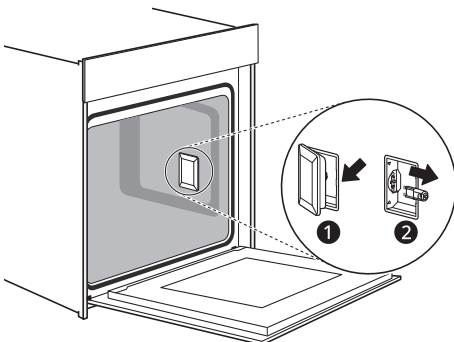

Removing and Assembling the Oven Door

⚠ CAUTION

- The door is very heavy. Be careful when removing, lifting and replacing the door.
- Do not lift the door by its handle. The handle is not designed to support the weight of the door when it has been removed from the oven.
- Do not hit the glass with pots, pans, or any other object.
- Scratching, hitting, jarring or stressing the glass may weaken its structure, causing an increased risk of breakage at a later time.
- Do not close the oven door until all the oven racks are fully in place.

Removing the Oven Door

1 Fully open the door.

2 Lift up the hinge lock **2** and flip it towards the hinge arm **3** completely.

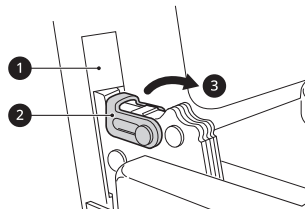

- 1** Slot
- 2** Hinge Lock
- 3** Hinge Arm

3 Firmly grasp both sides of the door at the top.

- Partially close the door to approximately 70 degrees ④. If the position is correct, the hinge arms will move freely.

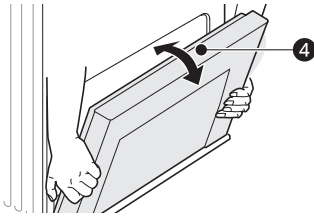

- Lift up the hinge lock ⑤ and flip it towards the oven ④ until it clicks into position.

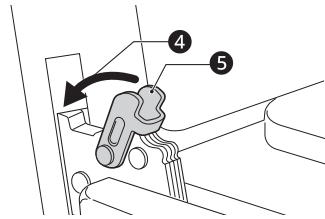

- Lift and pull the door towards you until the hinge latches are completely loosened.

- Close the door.

Assembling the Oven Door

- Firmly grasp both sides of the door at the top.

- Fully insert the hinge arms ① into the slots ② until the indentations ③ on the hinge arms rest on the bottom edges of the slots.

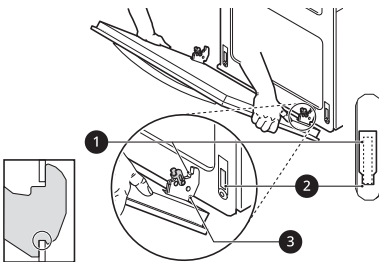

- ① Hinge Arm
- ② Bottom Edge of Slot
- ③ Indentation

- Slowly open the door fully. Make sure that the hinge arms are properly engaged in the slots.

Removing the Door Cover

The plastic inlay in the door cover may become discoloured. Remove the door cover if necessary to carry out a thorough cleaning.

- Remove the appliance door first before removing the door cover. Press the lockers on both sides of the cover.

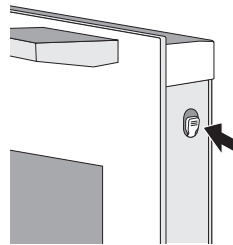

- Remove the cover.

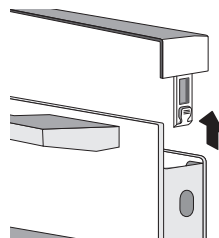

- After removing the door cover, the rest parts of the appliance door can be easily taken off so that you can go on with the cleaning. When the cleaning of the appliance door has finished,

put the cover back in place and press the lockers until they clicks audibly into place.

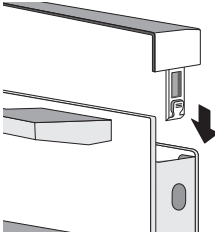

4 Assemble and refit the appliance door.

⚠ CAUTION

- Do not remove the door cover without the appliance door removed beforehand. Damage caused by incorrect operation is not covered under warranty.
- Keep your hands away from the hinges when removing the door cover and inner glass and/or closing the door.

NOTE

- Once the door cover is removed, the inner glass can be easily moved and it can cause damage and/or injury.

Changing the Power Cord

⚠ CAUTION

- To prevent creating a risk of electric shock, the power cord must be replaced only by the manufacturer, service agent or a qualified technician.

1 The terminal box is located on the back of the back outer case.

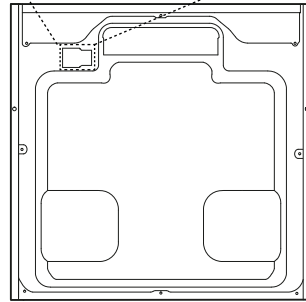
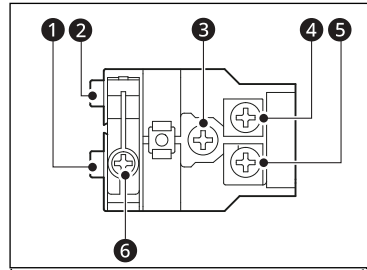

2 Cut off the power. Use a small flat screwdriver to open two snaps **1** and **2**.

3 Use a Phillips screwdriver to take off screws **3**, **4**, **5** and **6**.

4 Change the new power cord, fix the brown wire **7** on **4**, yellow/green wire **8** on **3**, blue wire **9** on **5**.

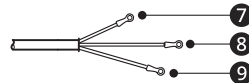

7 Brown (Live)

8 Yellow/Green (Ground)

9 Blue (Neutral)

Removing Rails

When you want have a good cleaning for the rails and cavity, you can remove the shelves and clean it. In this way your appliance will retain its appearance and remain fully functional for a long time.

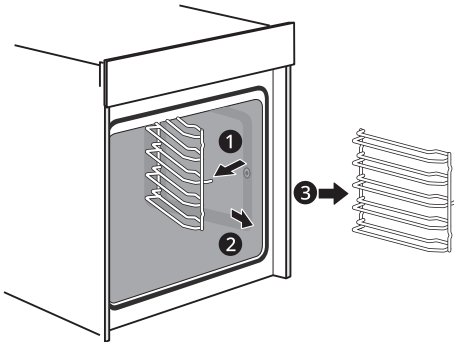

- 1 Pull the rail towards the other side to detach.
- 2 Insert the rail holders to attach and refit the rails.

Removing and Assembling the Telescopic Runners

Below procedures show removing and assembling the telescopic runners from the left side of the oven as an example. Do the same to remove and assemble the telescopic runners from the right side of the oven.

Removing the Telescopic Runners

- 1 Lift up one end of the telescopic runners hard.

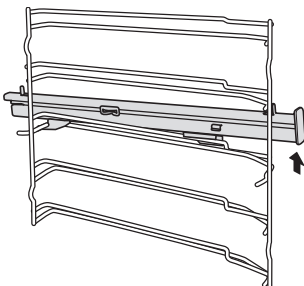

- 2 Lift up the whole telescopic runners and remove backward.

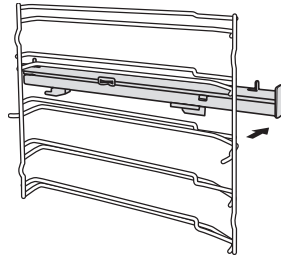

Assembling the Telescopic Runners

- 1 Put the ① and ② of the telescopic runners horizontally on the outer wire.

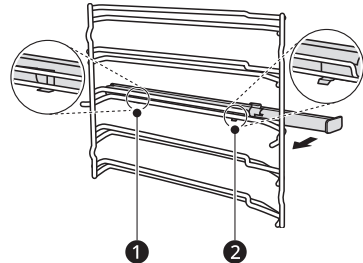

- 2 Rotate the telescopic runners anti-clockwise (clockwise for right side) by 90 degrees.

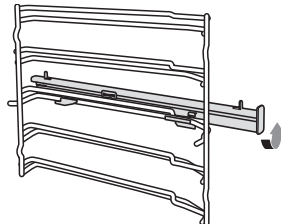

- 3** Push forward the telescopic runners, make the **3** buckled onto the lower wire and the **4** buckled onto the upper wire.

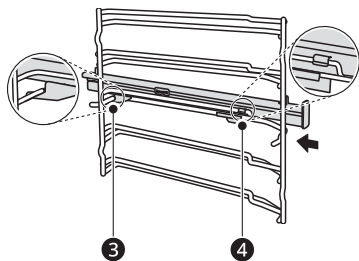

- 2** Take side rack out of the cavity together with the self-cleaning baffle.

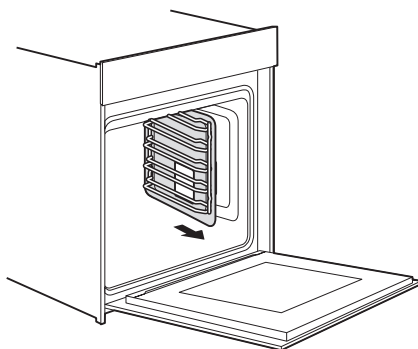

Removing and Assembling the Self-cleaning Baffle

Self-cleaning baffle is with special enameling treatment on its surface, which can absorb oil and fat, volatilize them out later on, make cavity clean and no peculiar smell during the process of cooking.

Removing the Self-cleaning Baffle

Take self-cleaning baffle out for the convenience of cleaning lateral sides of cavity:

- 1** Pull the side rack out from the cavity horizontally. The self-cleaning baffle will be pulled out together with the side rack.

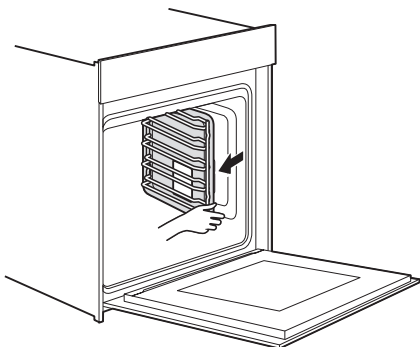

- 3** Separate the self-cleaning baffle from the side rack.

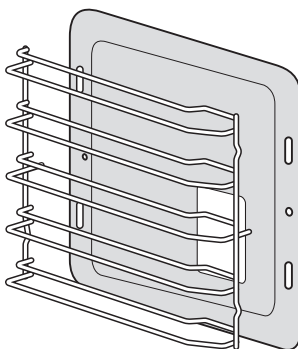

NOTE

- The telescopic runners, shelves, and self-cleaning baffles are optional accessories.

Assembling the Self-cleaning Baffle

Install side rack ① and self-cleaning baffle ② in turn according to direction as shown in the picture:

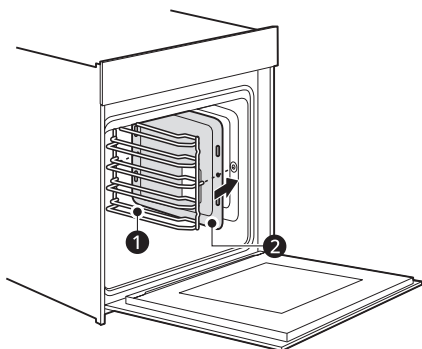

① Side Rack

② Self-cleaning Baffle

TROUBLESHOOTING

FAQs

Frequently Asked Questions

Q: My new oven doesn't cook like my old one. Is there something wrong with the temperature settings?

A: No. Your oven has been factory tested and calibrated. For the first few uses, follow your recipe times and temperatures carefully. If you still think your new oven is too hot or too cold, you can adjust the oven temperature yourself to meet your specific cooking needs. Refer to the **Changing Settings** section in this manual for easy instructions on how to adjust your thermostat.

Q: Is it normal to hear a clicking noise coming from the back of my oven when I am using it?

A: Your new appliance is designed to maintain a tighter control over your oven's temperature. You may hear your oven's heating elements click on and off more frequently on your new oven. This is NORMAL.

Q: During convection cooking the fan stops when I open the door. Is that normal?

A: Yes, this is normal. When the door is opened, the convection fan will stop until the door is closed.

Q: Can I use aluminum foil to catch drippings in my oven cavity?

A: Never use aluminum foil to line the bottom or sides of the oven. The foil will melt and stick to the bottom surface of the oven and will not be removable. Use a foil-lined sheet pan placed on a lower oven rack to catch drippings instead. Never place any rack, tray or pan on the base of the oven. (If foil has already melted onto the bottom of the oven, it will not interfere with the oven's performance.)

Q: Can I use aluminum foil on the racks?

A: Do not cover racks with aluminum foil. Covering entire racks with foil restricts air flow, leading to poor cooking results. Use a sheet pan lined with foil under fruit pies or other acidic or sugary foods to prevent spillovers from damaging the oven finish.

CAUTION

- Foil may be used to wrap food in the oven, but do not allow the foil to come into contact with the exposed heating/broiling elements in the oven. The foil could melt or ignite, causing smoke, fire, or injury.
-

Q: What should I do if my racks are sticky and have become hard to slide in and out?

A: Over time, the racks may become hard to slide in and out. Apply a small amount of olive oil to the sides of the racks. This will work as a lubricant for easier gliding.

Q: Should I broil with the door open or closed?

A: Your electric oven isn't designed for open door broiling. If you broil with the oven door open, it can damage the oven knobs or display.

Q: Why aren't the function buttons working?

A: Check if Child-Proof Lock is activated. The lock icon  will show in the display if Child-Proof Lock is activated. To deactivate Child-Proof Lock, refer to the Child-Proof Lock in Operation chapter.

Q: How can I help keep children safe around the appliance?

A: Children should be supervised around the appliance whenever it is in use, and after use until the oven surfaces have cooled. You can also use Child-Proof Lock to prevent children from accidentally turning on the oven. Child-Proof Lock disables most of control panel buttons. Refer to the Child-Proof Lock in Operation section.

Before Calling for Service

Cooking

Symptoms	Possible Cause & Solution
Oven will not work	Plug on appliance is not completely inserted in the electrical outlet. <ul style="list-style-type: none"> Make sure electrical plug is plugged into a live, properly grounded outlet.
	A fuse in your home may be blown or the circuit breaker tripped. <ul style="list-style-type: none"> Replace the fuse or reset the circuit breaker.
	Oven controls improperly set. <ul style="list-style-type: none"> See the "Operating the Oven" section in the Operation chapter.
Steam is exhausted through the oven vent.	Cooking foods with high moisture produces steam. <ul style="list-style-type: none"> This is normal.
Appliance does not operate.	Cord is not plugged in correctly. <ul style="list-style-type: none"> Make sure cord is plugged correctly into outlet. Check circuit breakers.
	Service wiring is not complete. <ul style="list-style-type: none"> Contact your electrician for assistance.
	Power outage. <ul style="list-style-type: none"> Check house lights to be sure. Call your local electric company for service.
Food does not bake or roast properly	Oven controls improperly set. <ul style="list-style-type: none"> See the "Operating the Oven" section in the Operation chapter.
	Rack position is incorrect or the rack is not level. <ul style="list-style-type: none"> See the "Operating the Oven" section in the Operation chapter.
	Incorrect cookware or cookware of improper size being used. <ul style="list-style-type: none"> See the "Operating the Oven" section in the Operation chapter.

Symptoms	Possible Cause & Solution
Food does not broil properly	Oven controls improperly set. <ul style="list-style-type: none"> • Make sure you select the Broil mode properly.
	Improper rack position being used. <ul style="list-style-type: none"> • See the Broiling Guide.
	Cookware not suited for broiling. <ul style="list-style-type: none"> • Use broiling pan and grid.
	In some areas the power voltage may be low. <ul style="list-style-type: none"> • Preheat the broil element for 5-7 minutes. See the Broiling Guide.
Moisture collects on oven window or steam comes from oven vent	This happens when cooking foods high in moisture. <ul style="list-style-type: none"> • This is normal.
	Excessive moisture was used when cleaning the window. <ul style="list-style-type: none"> • Do not use excessive moisture when cleaning the window.
Warm air venting into kitchen after oven has been turned off.	Warm air exhaust is needed to maintain and cool down oven temperatures. It turns off automatically when the heat cools to a safe temperature. <ul style="list-style-type: none"> • This is normal.

Parts & Features

Symptoms	Possible Cause & Solution
Knobs have fallen out of the control panel.	Knobs have been accidentally disengaged. <ul style="list-style-type: none"> • Knobs can be removed. • Simply place knobs back in their support in the control panel and push them in so that they engage and can be turned as usual.
Knobs can no longer be turned easily.	There is dirt under knobs. <ul style="list-style-type: none"> • Knobs can be removed. • To disengage knobs, simply remove them from the support. Alternatively, press on the outer edge of knobs so that they tip and can be picked up easily. • Carefully clean the knobs using a cloth and soapy water. Dry with a soft cloth. • Do not remove knobs too often so that the support remains stable.
Fan does not work all the time in "Fan Heating" mode.	This is a normal operation due to the best possible heat distribution and best possible performance of the oven. <ul style="list-style-type: none"> • Wait until the cooking cycle is completed.

Symptoms	Possible Cause & Solution
After a cooking process a noise can be heard and a air flow in the near of the control panel can be observed.	<p>The cooling fan is still working, to prevent high moisture conditions in the cavity and cool down the oven for your convenience.</p> <ul style="list-style-type: none"> The cooling fan will switch off automatically.
The food is not sufficient cooked in the time given by the recipe.	<p>A temperature different from the recipe is used.</p> <ul style="list-style-type: none"> Double check the temperatures. The ingredient quantities are different to the recipe. Double check the recipe.

Information Mode Power Consumption

COMMISSION REGULATION (EU) No 801/2013 and (EU) No 1275/2008, Applicable Standard EN 50564:2011

Information mode power consumption	1.00 W
The period of time after which the power management function, or a similar function, switches the equipment automatically into standby and/or off mode and/or the condition providing networked standby	NA

Customer Service

Our after-sales service is there for you if your appliance needs to be repaired. We will always find an appropriate solution. Please contact the dealer where you by this appliance. When calling us, please give the model number and the serial number (S/N) so that we can provide you with the correct advice. The rating plate bearing these numbers can be found when you open the appliance door.

Rated Voltage	220-240 V~
Rated Frequency	50-60 Hz (Saudi Arabia only) 50 Hz (except Saudi Arabia)
Electric Power	2.9 kW
Country of Origin	China

Maintenance Card

To save time, make a note of the model of your appliance and the telephone number of the after sales service in the space below, should it be required.

Model Number		Purchasing Date	
Serial Number		Purchasing Store	

Memo

Memo

Memo

