

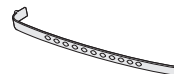

**LED TV**  
43/50/55/65US662H\*  
43/50/55US665H\*

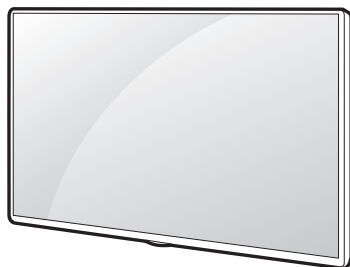

▶ [www.lg.com/id-manual](http://www.lg.com/id-manual)



⊕ : Depending on model / В зависимости от модели / Závísí na modelu / Selon le modèle / Abhängig vom Modell / Ανάλογα με το μοντέλο /  
Típusfüggő / In base al modello / Zależnie od modelu / Dependendo do modelo / În funcție de model / U zavisnosti od modela /  
Ovisno o modelu / Odvisno od modela / En función del modelo



### English

- Read **Safety and Reference**.
- You can download more detailed information on our website by entering the full model number.
- For the power supply and power consumption, refer to the label attached to the product.

### Български

- Прочетете **Безопасност и справка**.
- Можете да свалите по-подробна информация на нашия уебсайт като въведете целия номер на модела.
- Направете справка с етикета на продукта за електрозахранването и консумацията на енергия.

### Français

- Lire le document **Sécurité et référence**.
- Vous pouvez télécharger des informations plus détaillées sur notre site Web en saisissant la référence complète du modèle.
- Reportez-vous à l'étiquette apposée sur le téléviseur pour connaître l'alimentation et la consommation électriques.

### Ελληνικά

- Ανάγνωση **Ασφάλεια και αναφορά**.
- Μπορείτε να κατεβάσετε πιο αναλυτικές πληροφορίες από τη διαδικτυακή τοποθεσία μας συμπληρώνοντας τον πλήρη αριθμό μοντέλου.
- Για πληροφορίες σχετικά με την τροφοδοσία και την κατανάλωση ενέργειας, δείτε την ετικέτα του προϊόντος.

### Italiano

- Consultare la sezione **Sicurezza e informazioni di riferimento**.
- È possibile scaricare informazioni più dettagliate sul sito Web inserendo il numero completo del modello.
- Per l'alimentazione e il consumo di energia, consultare l'etichetta applicata sul prodotto.

### Português

- Consulte o manual de **Segurança e Referência**.
- Pode transferir informações mais detalhadas no nosso site ao introduzir o número completo do modelo.
- No que respeita à fonte de alimentação e ao consumo de energia, consulte a etiqueta mostrada no produto.

### Česky

- Přečtěte si část **Bezpečnost a reference**.
- Podrobnější informace si můžete stáhnout z našich webových stránek po zadáním kompletního čísla modelu.
- Informace o napájení a příkonu naleznete na štítku připevněném k výrobku.

### Deutsch

- **Sicherheitshinweise und Referenzen:** Bitte lesen!
- Genauer Informationen können Sie von unserer Webseite herunterladen, indem Sie die vollständige Modellnummer eingeben.
- Informationen zur Stromversorgung und zum Stromverbrauch sind dem Etikett auf dem Gerät zu entnehmen.

### Magyar

- Lásd: **Biztonsági óvintézkedések**.
- A teljes modellszám megadásával letölthet részletesebb információkat a weboldalunkról.
- A tápellátásra és az áramfogyasztásra vonatkozó adatok a készülékre ragasztott címkén találhatóak.

### Polski

- Przeczytaj **Zasady bezpieczeństwa i informacje dodatkowe**.
- Bardziej szczegółowe informacje można pobrać z naszej strony internetowej po wprowadzeniu pełnego numeru modelu.
- Dokładne informacje o zasilaniu i zużyciu energii są umieszczone na etykietach znajdujących się na produkcie.

### Română

- Citiți **Siguranță și referințe**.
- Puteți să descărcați informații mai detaliate de pe site-ul nostru web, introducând numărul complet al modelului.
- Pentru sursa de alimentare și consumul de energie, consultați eticheta atașată pe produs.

### Srpski

- Pročitajte **Bezbednost i informacije**.
- Detaljnije informacije možete da preuzmete na našem web-sajtu unosom celog broja modela.
- Da biste saznali informacije u vezi sa napajanjem i potrošnjom energije, pogledajte oznaku na proizvodu.



### Hrvatski

- Pročitajte **Sigurnost i reference**.
- Možete preuzeti detaljnije informacije na našoj web stranici tako da unesete cijeli broj modela.
- Informacije o napajanju i potrošnji energije potražite na oznaci koja se nalazi na proizvodu.

### Español

- Leer **Seguridad y Referencias**.
- Puede descargar información más detallada desde nuestro sitio web introduciendo el número de modelo completo.
- Para obtener información acerca de la fuente de alimentación y el consumo de energía, consulte la etiqueta del producto.

### Slovenščina

- Preberite **Varnostne informacije in napotki**.
- Bolj podrobne informacije lahko prenesete z našega spletnega mesta, tako da vnesete celotno številko modela.
- Podatke o napajanju in porabi energije si oglejte na nalepki izdelka.

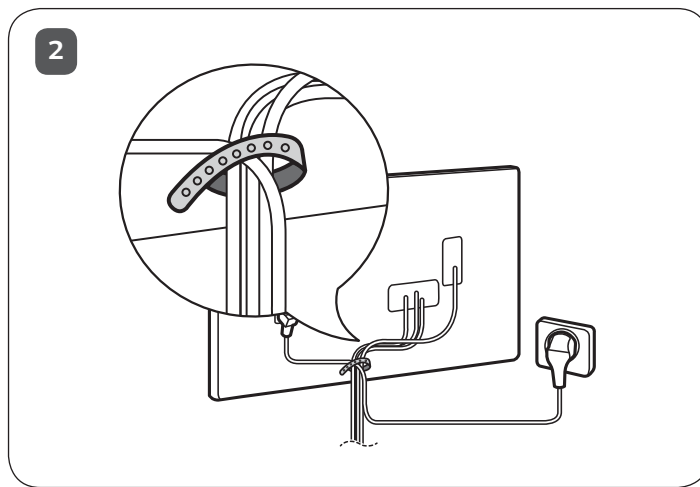
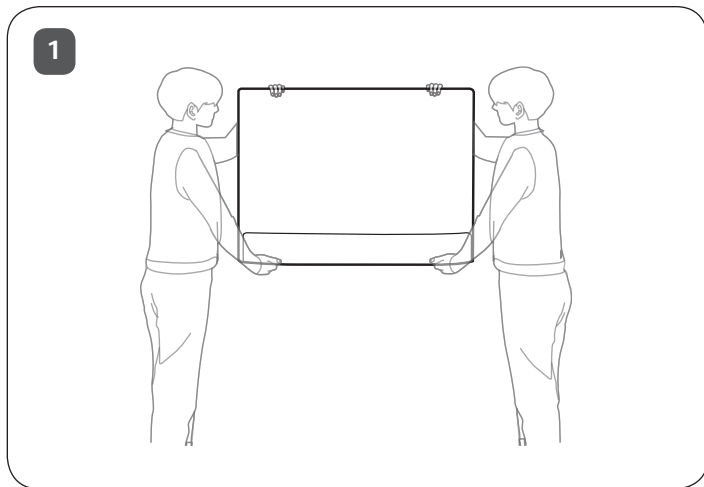

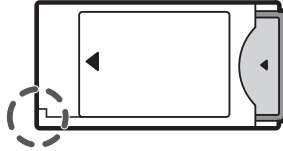
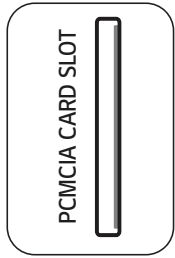
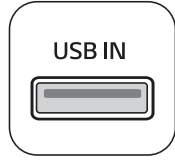
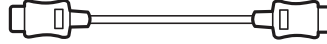
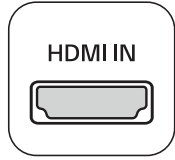
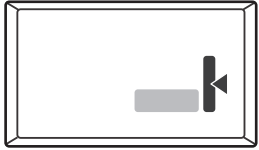

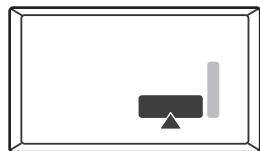

ANTENNA /  
CABLE IN

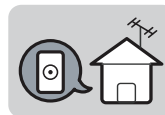
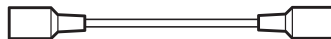

Satellite IN



HDMI IN/ARC

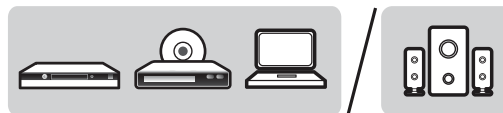
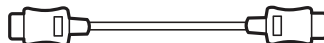

HDMI IN

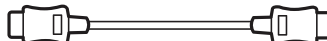

OPTICAL  
DIGITAL  
AUDIO OUT



EXTERNAL  
SPEAKER OUT

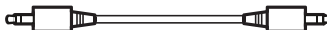

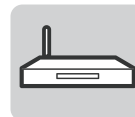
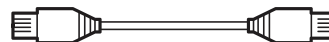
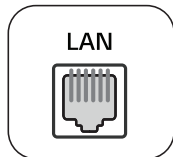
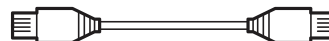
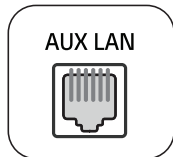
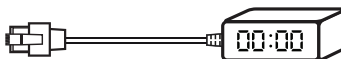
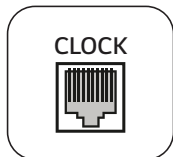
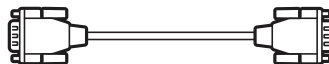
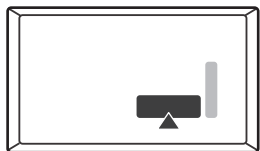

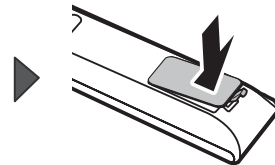
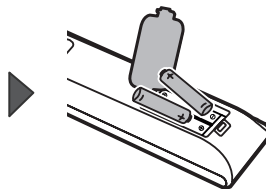
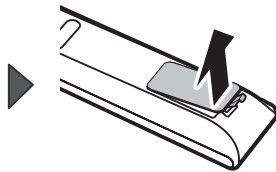
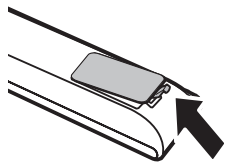
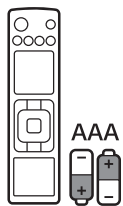

\* M F L 7 1 6 9 7 8 0 2 \*



(2010-REV01)

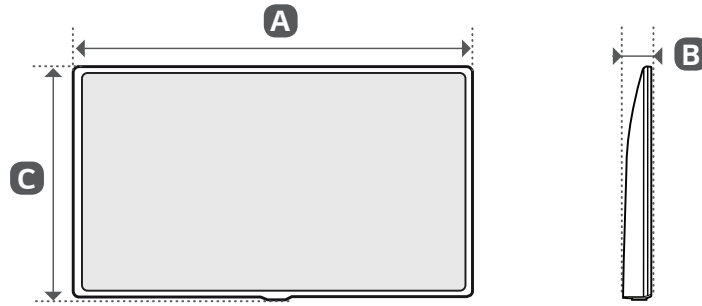

	A	B	C	D
	(mm)			(kg)
43US662H0ZC 43US665H0ZC	973	85.0	572	8.0
50US662H0ZC 50US665H0ZC	1130	86.3	663	11.3
55US662H0ZC 55US665H0ZC	1244	87.1	726	14.3
65US662H0ZC	1463	87.8	850	21.4
Power requirement			AC 100-240 V ~ 50 / 60 Hz	