



OWNER'S MANUAL

LG Digital Signage (MONITOR SIGNAGE)

Please read this manual carefully before operating your set and retain it for future reference.

23SE3TE

www.lg.com

Copyright © 2018 LG Electronics Inc. All Rights Reserved.

TABLE OF CONTENTS

IMPORTANT PRECAUTIONS.....3

- Electrical Power Related Precautions.....3
- Precautions In Installing the Product.....5
- Precautions for Moving the Product.....6
- Precautions for Using/Cleaning the Product...7
- Product Disposal (Only, Hg lamp used LCD Monitor).....7

LICENSES.....8

ASSEMBLY AND PREPARATION .8

- Parts9
- Portrait Layout.....9
- Moving and Lifting the Monitor.....10
- Installing the Monitor.....11

MAKING CONNECTIONS..... 15

- Connecting to a PC.....15
- External Device Connection.....15

USER SETTINGS 17

- User Settings18
- SMART ENERGY SAVING25
- Picture Mode.....26

TROUBLESHOOTING..... 27

PRODUCT SPECIFICATIONS..... 31

WARNING: This equipment is compliant with Class A of CISPR 32. In a residential environment this equipment may cause radio interference.

IMPORTANT PRECAUTIONS

Please read these safety precautions carefully before using the product.

WARNING

Failure to follow those warnings may result in death, serious injury or damage to the product or other property.

CAUTION

If you ignore the caution message, you may be slightly injured or the product may be damaged.

WARNING

- Indoor Use Only.

Electrical Power Related Precautions

WARNING

- Use only the power cord supplied with the unit or another manufacturer's authorized cord.
 - Failure to do so may result in fire or electrical shock or damage to the product.
- Use only a properly grounded plug and receptacle.
 - If you do not you may be electrocuted or injured. Or the product might be damaged.
- Do not use a damaged or loose plug.
 - This may cause electrical shock or fire.
- Operate the display only from a power source(i.e. voltage) indicated in the product specification.
 - Otherwise the product can be damaged, fire can occur or you may be electrocuted. If you are not sure what type of power supply you have, consult a certified electrician.
- In the presence of thunder and lightning, never touch the power cord and signal cable because it can be very dangerous.
 - It can cause electric shock.
- Do not connect several extension cords, electrical appliances or electrical heaters to a single outlet. Use a power strip with a grounding terminal designed for exclusive use with the computer.
 - A fire can break out due to overheating.
- Do not touch the power plug with wet hands. Additionally, if the cord pin is wet or covered with dust, dry the power plug completely or wipe dust off before plugging in the cord.
 - You may be electrocuted due to excess moisture.

- If you don't intend to use the product for a long time, unplug the power cable from the product.
 - Layers of dust can cause a fire, or insulation deterioration can cause electric leakage, electric shock or fire.
- Insert the power plug firm so it cannot come loose.
 - A loose connection can cause fire.
- Hold the plug when pulling out the power cable. Do not pull the plug out by the wire. Do not bend the power cord with excessive force or put heavy objects on the power cord.
 - The power line can be damaged, which may cause electric shock or fire.
- Do not insert metal or other conductive materials into the product openings. Additionally, do not touch the power cable right after plugging into the wall input terminal.
 - You may be electrocuted.
- Use an appliance coupler as a disconnect device.
- Please make sure the device is installed near the wall outlet to which it is connected and that the outlet is easily accessible.
- Do not unplug the power cord while the product is in use.
 - Electrical shock can damage the product.
- As long as this unit is connected to the AC wall outlet, it is not disconnected from the AC power source even if the unit is turned off.

Precautions In Installing the Product

WARNING

- Keep away from heat sources like heaters or open flames.
 - Electrical shock, fire, malfunction or deformation may occur.
- Keep the packing anti-moisture material or vinyl packing out of the reach of children.
 - Anti-moisture material is harmful if swallowed. If swallowed by mistake, force the patient to vomit and visit the nearest hospital. Additionally, vinyl packing can cause suffocation. Keep it out of the reach of children.
- Do not put heavy objects on the product or sit upon it.
 - If the product collapses or is dropped, you may be injured. Prevent Children from climbing or pulling on the unit.
- Do not leave the power or signal cable where someone can trip over it.
 - Pedestrians may become entangled in the cables and cause the device to become damaged causing electrical shock, fire, or serious injury.
- Install the product in a neat and dry place. Do not use near water.
 - Dust or moisture can cause electrical shock, fire or product damage.
- Do not add accessories that have not been designed for this display.
- If you smell smoke or other odors or hear a strange sound from the product unplug the power cord and contact LG Customer Service.
 - If you continue to use without taking proper measures, electrical shock or fire can occur.
- If you dropped the product or the case is broken, turn off the product and unplug the power cord.
 - If you continue to use without taking proper measures, electrical shock or fire can occur. Contact LG Customer Service.
- Do not drop an object on or apply impact to the product. Do not throw any toys or objects at the product.
 - It can cause injury to humans, problems to the product and damage the display.
- Keep out of reach of children and do not place toys near the product.
- Make sure the product ventilation hole is not blocked. Install the product more than 100 mm (3.9 inches) from the wall.
 - If you install the product too close to the wall, it may be deformed or fire can break out due to internal heat build-up.
- Do not cover the product with cloth or other material (eg. plastic) while plugged in.
 - The product can be deformed or fire can break out due to internal overheating.
- Place the product on a flat and stable surface that is large enough to support the product.
 - If the product is dropped, you may be injured or the product may be broken.
- Install the product where no Electromagnetic Interference occurs.
- Keep the product away from direct sunlight.
 - The product can be damaged.
- Do not place the product on the floor.
 - Small Children and others may trip over it.
- Do not install this product on a wall if it could be exposed to oil or oil mist.
 - This may damage the product and cause it to fall.
- For displays with glossy bezels the user should consider the placement of the display as the bezel may cause unwanted reflections from surrounding light and bright surfaces.

Precautions for Moving the Product

WARNING

- Make sure to turn off the product.
 - You may be electrocuted or the product can be damaged.
- Make sure to remove all cables before moving the product.
 - You may be electrocuted or the product can be damaged.
- When lifting or moving the product, do not hold it upside down while holding only the stand.
 - This may cause the product to fall resulting in damage or injury.
- Do not shock the product when moving it.
 - You may be electrocuted or the product can be damaged.
- Make sure the panel faces forward and hold it with both hands to move.
 - If you drop the product, the damaged product can cause electric shock or fire.
- Do not place the product face down.
 - This may damage the TFT-LCD screen.

Precautions for Using/Cleaning the Product

⚠ WARNING

- Do not attempt to disassemble, repair or modify the product yourself.
 - Fire or electric shock can occur.
 - Contact LG Customer Service for repair.
- When cleaning the product, unplug the power cord and scrub gently with a soft cloth to prevent scratching. Do not clean with a wet cloth or spray water or other liquids directly onto the product. An electric shock may occur. (Do not use chemicals such as benzene, paint thinners or alcohol.)
- Keep the product away from water.
 - Fire or electric shock accident can occur.
- Avoid high temperatures and humidity.
- Do not put or store flammable substances near the product.
 - There is a danger of explosion or fire.
- Keep the product clean at all times.
- Take a comfortable and natural position when working with the product.
- Take a regular break when working with the product for a long time.
- Do not press on the panel with a hand or sharp object such as nail, pencil or pen, or make a scratch on it.
- Keep proper distance from the product and rest from time-to-time.
 - Your vision may be impaired if you look at the product too closely or for too long.
- Set the appropriate resolution by referring to the User's Guide.
- Keep small accessories out of the reach of children.
- Displaying a still image for long time on the monitor may leave persistent image or stain on the monitor screen. To avoid this problem, use a screen saver and power off when this product is not used. Persistent image or stain caused by long time usage are not covered by the warranty on this product.
- Do not use products using high voltage around the Monitor. (ex. Electrical Swatter)
 - Monitor may have malfunction as its electrical shock.
- Spray water onto a soft cloth 2 to 4 times, and use it to clean the front frame; wipe in one direction only. Too much moisture may cause staining.

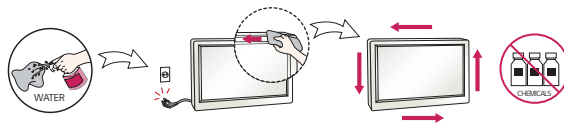

Product Disposal (Only, Hg lamp used LCD Monitor)

- The fluorescent lamp used in this product contains a small amount of mercury.
- Do not dispose of this product with general household waste.
- Disposal of this product must be carried out in accordance to the regulations of your local authority.

LICENSES

Supported licenses may differ by model. For more information of the licenses, visit www.lg.com.



The terms HDMI and HDMI High-Definition Multimedia Interface, and the HDMI Logo are trademarks or registered trademarks of HDMI Licensing Administrator, Inc. in the United States and other countries.

NOTE

- Multi touch does not work.
 - Only support Windows 7 and Windows 8 system.
 - Windows 7 Starter, Home basic version are not support multi-touch as default option.
 - Please check the details on the homepage of the Microsoft.
- Touch does not respond when the desktop is extended to a second touch monitor. For more information.(See p.29)

ASSEMBLY AND PREPARATION

CAUTION

- Always use genuine components to ensure safety and product performance.
- The product warranty will not cover damage or injury caused by the use of counterfeit components.
- It is recommend that use the supplied components.
- If you use generic cables not certified by LG, the screen may not display or there may be image noises.

NOTE

- The accessories provided with your product may vary depending on the model or region.
- Product specifications or contents in this manual may be changed without prior notice due to upgrade of product functions.
- The warranty will not cover any damage caused by using the product in an excessively dusty environment.

Parts

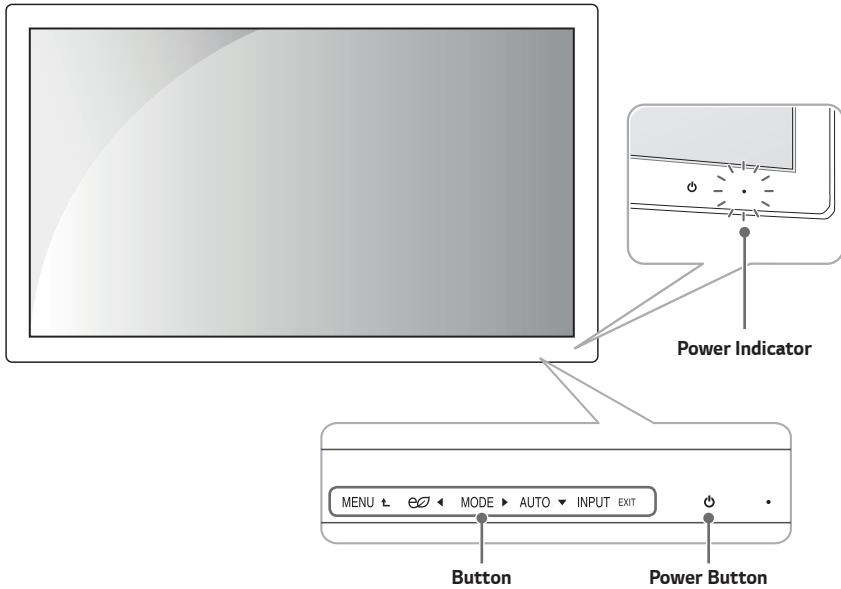

Power Indicator: This Indicator lights up red when the display operates normally (on mode).
(Sleep Mode: Blinking Red)

Portrait Layout

When installing in a portrait layout, rotate the monitor counterclockwise 90 degrees (when facing the screen).

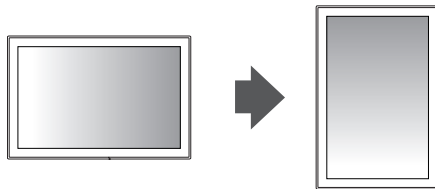

Moving and Lifting the Monitor

When moving or lifting the monitor, follow these instructions to prevent the monitor from being scratched or damaged and to ensure safe transportation, regardless of its shape or size.

- Place the monitor in the original box or packing material before attempting to move it.
- Before moving or lifting the monitor, disconnect the power cord and all other cables.
- Hold the bottom and side of the monitor frame firmly. Do not hold the panel itself.

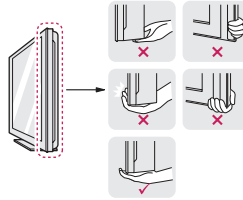

- When holding the monitor, the screen should face away from you to prevent it from being scratched.



- When transporting the monitor, do not expose the monitor to shock or excessive vibration.
- When moving the monitor, keep it upright and never turn the monitor on its side or tilt it sideways.

CAUTION

- Avoid touching the monitor screen as much as possible.
 - This may result in damage to the screen or some of the pixels used to create images.

Installing the Monitor

Installing on a Table

- 1 Lift the monitor and place it on the table in an upright position. Place the monitor at least 100 mm (3.9 inches) away from the wall to ensure sufficient ventilation.

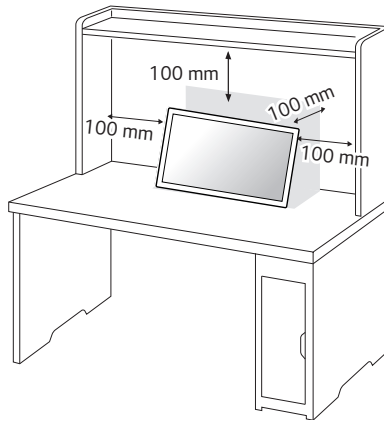

- 2 Connect the power adapter to the monitor and then plug the power cord into the wall outlet.

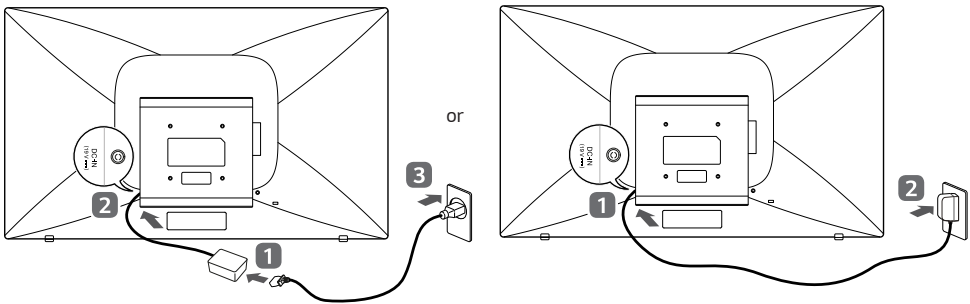

- 3 Press the  (Power) button on the front panel to turn the power on.

CAUTION

- Unplug the power cord before moving the Monitor to another location. Otherwise electric shock may occur.

NOTE

- Avoid using the product in a high temperature and high humidity area. Moving the monitor from a environment like this to an air conditioned area may cause moisture formation inside the glass. This moisture will be dissipate over time, which may vary depending on the operating environment.

Using the Kensington Lock

The Kensington security system connector is located at the back of the monitor. For more information on installation and use of this system, refer to the manual provided with the Kensington security system or visit <http://www.kensington.com>.

Connect the Kensington security system cable between the monitor and a table.

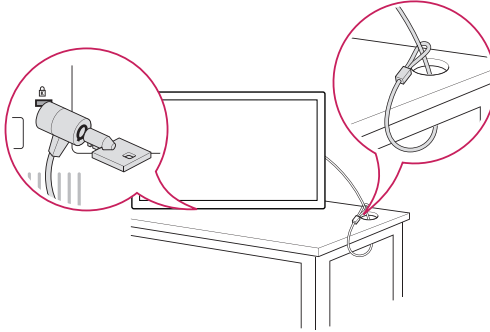
**! NOTE**

- The Kensington security system is optional. You can obtain additional accessories from most electronics retail stores.

Installing on a Wall

For proper ventilation, allow a clearance of 100 mm (3.9 inches) on each side and from the wall. Detailed installation instructions are available from your dealer, see the optional Tilt Wall Mounting Bracket Installation and Setup Guide.

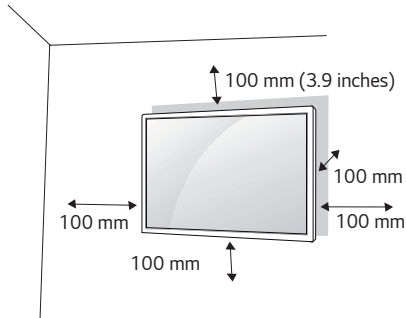

To install your monitor on a wall, attach a wall mounting bracket (optional part) to the back of the monitor. Make sure that the wall mounting bracket is securely fixed to the monitor and to the wall.

- 1 Use only screws and wall mounting brackets that conform to VESA standards.
 - 2 Screws which are longer than standard length may damage the inside of the monitor.
 - 3 A non-VESA standard screw may damage the product and cause the monitor to fall. LG Electronics is not liable for any accidents related to the use of non-standard screws.
 - 4 VESA compatible.
 - 5 Please use VESA standard as below.
- 784.8 mm (30.8 inches) and under
 - Wall Mount Pad Thickness: 2.6 mm (0.10 inches)
 - Fixing screws: Diameter 4.0 mm (0.15 inches) x Pitch 0.7 mm (0.02 inches) x Length 10 mm (0.39 inches)
 - 787.4 mm (31 inches) and above
 - Please use VESA standard wall mount pad and screws.

Model	23SE3TE
VESA (A x B)	75 x 75
Fixing screws	M4
Number of screws	4

 **CAUTION**

- Disconnect the power cord before moving or installing the monitor to avoid risk of electric shock.
- If you install the monitor on a ceiling or slanted wall, it may fall and result in injury. Use an authorized LG wall mount and contact your local dealer or qualified personnel to assist with the installation.
- Do not over tighten the screws as this may damage the monitor and void your warranty.
- Use only screws and wall mounting brackets that meet the VESA standard. Any damage or injuries caused by misuse or use of improper accessories are not covered by the warranty.

 **NOTE**

- Use the screws that are listed on the VESA standard screw specifications.
- The wall mount kit includes the installation guide and all necessary parts.
- The wall mounting bracket is optional. You can obtain additional accessories from your local dealer.
- The length of screws required may differ depending on the wall mount. Be sure to use the correct length.
- For more information, please refer to the guide provided with the wall mount.

MAKING CONNECTIONS

You can connect various external devices to your monitor. Change the input mode and select the external device you want to connect. For more information about external device connections, see the user manual provided with each device.

Connecting to a PC

Some of the cables are not provided.

This monitor supports the Plug and Play* feature.

* Plug and Play: a feature that enables a PC to recognize devices attached by the user without device configuration or user intervention when powering up.

External Device Connection

Connect a HD receiver, DVD, or VCR player to the monitor and select an appropriate input mode.

Some of the cables are not provided. For the best picture and sound quality, connecting external devices to your monitor using HDMI cables is recommended.

! NOTE

- For the best image quality, using the monitor with HDMI connection is recommended.
- To comply with the specifications of the product, use a shielded interface cable with ferrite core, such as a DVI-D cable.
- If you turn the monitor on when the set is cold, the screen may flicker. This is normal.
- Sometimes red, green, or blue spots may appear on the screen. This is normal.
- Use a High Speed HDMI®/TM cable.
- Use a certified cable with the HDMI logo attached. If you do not use a certified HDMI cable, the screen may not display or a connection error may occur.
- Recommended HDMI Cable Types
 - High-Speed HDMI®/TM Cable
 - High-Speed HDMI®/TM Cable with Ethernet
- If you cannot hear any sound in HDMI mode please check your PC settings. Some PCs require you to manually change the default audio output to HDMI.
- If you want to use HDMI-PC mode, you must set your PC/DTV to PC mode.
- You may experience compatibility issues if you use HDMI-PC mode.
- Make sure the power cable is disconnected.
- If you connect a gaming device to the monitor, use the cable provided with the gaming device.
- It is recommended to use the speakers that are provided as optional accessories.
- High Speed HDMI®/TM cables transmit a HD signal up to 1080p and higher.

⚠ CAUTION

- Connect the signal input cable and tighten it by turning the screws clockwise.
- Do not press the screen with your finger for a prolonged period as this may result in temporary distortion on the screen.
- Avoid displaying static images on the screen for a long period of time to prevent image burn. Use a screensaver if possible.
- A wireless communication device near your monitor can affect the image.

USER SETTINGS

- 1 Press the desired button on the bottom of the Monitor.
- 2 Change the value of the menu item by pressing the buttons on the bottom of the Monitor. To return to the upper menu or set other menu items, use the up arrow (⬆) button.
- 3 Select **EXIT** to leave the OSD menu.

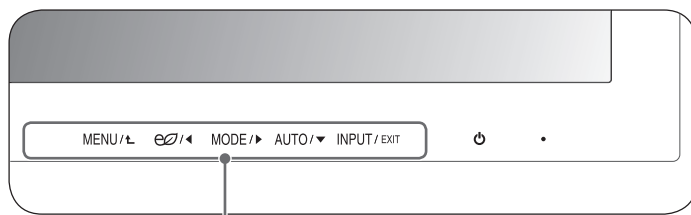

Monitor set Buttons

Button	Description
MENU / L	<p>Accesses the main menus.</p> <ul style="list-style-type: none"> • OSD LOCKED/UNLOCKED: This function allows you to lock the current control settings, so that they cannot be inadvertently changed. <ul style="list-style-type: none"> - Press and hold the Menu button for a few seconds. Then, you will be prompted to set the OSD Lock. - You can unlock the OSD controls at any time by pushing the MENU button for several seconds. The message "OSD UNLOCKED" should appear.
e / <	Enables the SMART ENERGY SAVING function.
MODE / >	Goes to the Picture Mode menu.
AUTO / >	<p>When adjusting your display settings, always press the AUTO button. (Only supported in Analog Mode)</p> <ul style="list-style-type: none"> • The best display mode: 1920 x 1080
INPUT / EXIT (INPUT / EXIT)	<p>You can choose the input signal.</p> <ul style="list-style-type: none"> • When two input signals are connected, you can select the input signal (D-SUB/HDMI) you want. • When only one signal is connected, it is automatically detected. The default setting is D-SUB. • EXIT: Exit the OSD (On Screen Display).
⏻ (Power Button)	<p>Turns the power on or off.</p> <ul style="list-style-type: none"> • Power Indicator: When the monitor is in operating mode, the power indicator will turn red (on mode). When the monitor is in power-saving mode, the power indicator will blink red.

! NOTE

- All of the buttons are touch sensitive and can be operated by simply touching their label with your finger.

User Settings

Menu Settings

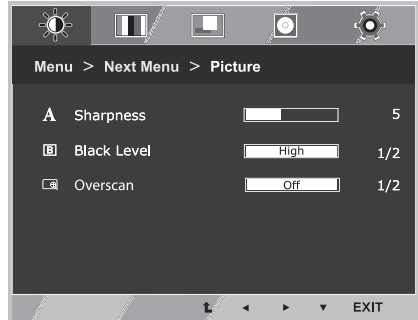

- 1 Press **MENU** button on the bottom of the Monitor set to display the **Menu** OSD.
- 2 Set the options by pressing the ◀ or ▶ or ▼ buttons.
- 3 Select the **Next Menu** button to enter the more option settings.
- 4 Select **EXIT** to leave the OSD menu. To return to the upper menu or set other menu items, use the up arrow (⬆) button.

Each option is explained below.

Menu	Analog	HDMI	Description
Brightness	0	0	To adjust the brightness, contrast of the screen
Contrast	0	0	
Wide/Original	0	0	<ul style="list-style-type: none"> • Wide: Switch to full screen mode according to input image signal. • Original: Change the input image signal ratio to original. This function works only if input resolution is lower than Monitor set ratio (16:9).
Reset	0	0	Restore all factory default settings. Press the ◀ ▶ buttons to reset immediately.

Menu > Next Menu	Analog	HDMI	Description	
Picture	Sharpness	0	0	To adjust the clearness of the screen
	Black Level		0	To set offset level
	Overscan		0	To improve the clarity and stability of the screen
Color	Gamma	0	0	To customize the color of the screen
	Color Temp			
	Six Color			
	Color Reset			
Display	Horizontal	0		To adjust the position of the screen
	Vertical			
	Clock	0		To improve the clarity and stability of the screen
	Phase			
Audio		0		To adjust the Volume
Others	Language	0	0	To customize the screen status for a user's operating environment
	Power Indicator			
	Automatic Standby			
	Response Time			

- **Analog:** D-SUB(Analog signal) input.
- **HDMI:** HDMI(Digital signal) input.

Picture

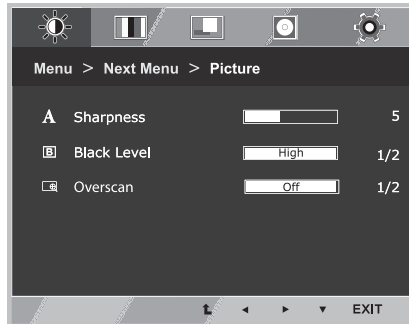

- 1 Press **MENU** button on the bottom of the Monitor set to display the **Menu** OSD.
- 2 Select the **Next Menu** button to enter the more option settings.
- 3 Enter to **Picture** by pressing the **▼** button.
- 4 Set the options by pressing the **◀** or **▶** or **▼** buttons.
- 5 Select **EXIT** to leave the OSD menu. To return to the upper menu or set other menu items, use the up arrow (**⬆**) button.

Each option is explained below.

Menu > Next Menu > Picture	Description
Sharpness	To adjust the clearness of the screen.
Black Level	You can set the offset level. If you select High , the screen will be bright and if you select Low , the screen will be dark. (only for HDMI input) <ul style="list-style-type: none"> • Offset: As the criteria for video signal, it is the darkest screen the monitor can show.
Overscan	To select the range of output image for DTV timing in HDMI input. (only for HDMI input) Recommend overscan function to turn on when connect AV equipment.

Color

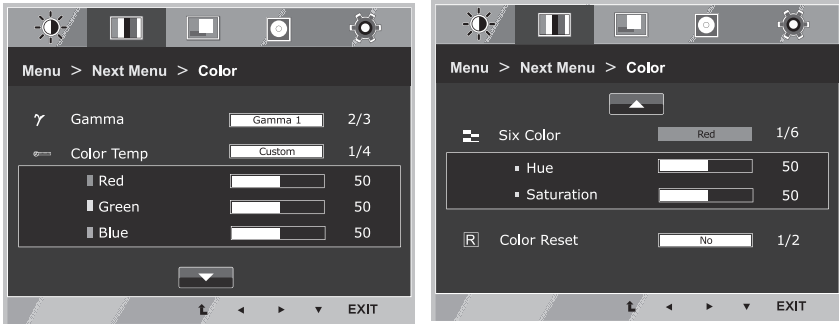

- 1 Press **MENU** button on the bottom of the Monitor set to display the **Menu** OSD.
- 2 Select the **Next Menu** button to enter the more option settings.
- 3 Select **Color** by pressing the **▶** button.
- 4 Enter to **Color** by pressing the **▼** button.
- 5 Set the options by pressing the **◀** or **▶** or **▼** buttons.
- 6 Select **EXIT** to leave the OSD menu. To return to the upper menu or set other menu items, use the up arrow (**⬆**) button.

Each option is explained below.

Menu > Next Menu > Color	Description
Gamma	Set your own gamma value. : Gamma 0, Gamma 1, Gamma 2 on the monitor, high gamma values display whitish images and low gamma values display blackish images.
Color Temp	<p>Custom</p> <ul style="list-style-type: none"> • Red, Green, Blue: Set your own red, green and blue color levels. • Warm: Set the screen to warm color temperature (more red). • Medium: Set the screen to medium color temperature. • Cool: Set the screen to cool color temperature (more blue).
Six Color	<p>Sets and stores the hue and saturation for six colors(Red/Green/Blue/Cyan/Magenta/Yellow) to satisfy the color requirements of a user.</p> <ul style="list-style-type: none"> • Hue: Adjusts the screen hue. • Saturation: Adjusts the color sharpness on the screen. Lower values make the color sharpness weaker and colors lighter while higher values make the color sharpness stronger and colors dark.
Color Reset	Resets the color settings to the factory default settings for the current input device.

Display

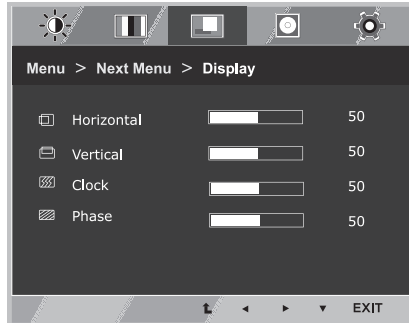

- 1 Press **MENU** button on the bottom of the Monitor set to display the **Menu** OSD.
- 2 Select the **Next Menu** button to enter the more option settings.
- 3 Select **Display** by pressing the **►** button.
- 4 Enter to **Display** by pressing the **▼** button.
- 5 Set the options by pressing the **◀** or **▶** or **▼** buttons.
- 6 Select **EXIT** to leave the OSD menu. To return to the upper menu or set other menu items, use the up arrow (**⬆**) button.

Each option is explained below.

Menu > Next Menu > Display	Description
Horizontal	To move image left and right.
Vertical	To move image up and down.
Clock	To minimize any vertical bars or stripes visible on the screen background. The horizontal screen size will also change.
Phase	To adjust the focus of the display. This item allows you to remove any horizontal noise and clear or sharpen the image of characters.

Audio

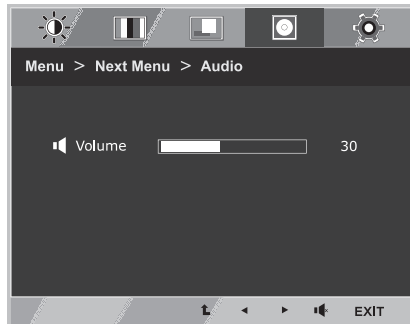

- 1 Press **MENU** button on the bottom of the Monitor set to display the **Menu** OSD.
- 2 Select the **Next Menu** button to enter the more option settings.
- 3 Select **Audio** by pressing the **▶** button.
- 4 Enter to **Volume** by pressing the **▼** button.
- 5 Set the options by pressing the **◀** or **▶** buttons.
- 6 Select **EXIT** to leave the OSD menu. To return to the upper menu or set other menu items, use the up arrow (**⬆**) button.

Each option is explained below.

Menu > Next Menu > Audio	Description
Volume	To adjust the Volume of headphone/earphone. (Only for HDMI input)

Others

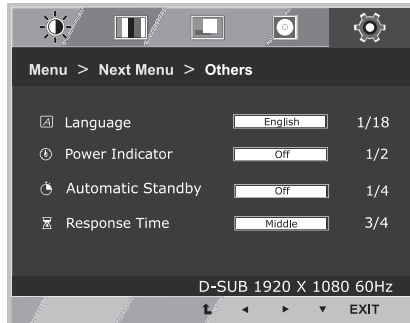



- 1 Press **MENU** button on the bottom of the Monitor set to display the **Menu** OSD.
- 2 Select the **Next Menu** button to enter the more option settings.
- 3 Select **Others** by pressing the **▶** button.
- 4 Enter to **Others** by pressing the **▼** button.
- 5 Set the options by pressing the **◀** or **▶** or **▼** buttons.
- 6 Select **EXIT** to leave the OSD menu. To return to the upper menu or set other menu items, use the up arrow (**⬆**) button.

Each option is explained below.

Menu > Next Menu > Others	Description
Language	Chooses the language of the OSD.
Power Indicator	Activates/deactivates the power indicator LED. <ul style="list-style-type: none"> • On: The power indicator is automatically turned on. • Off: The power indicator is turned off.
Automatic Standby	Once the specified standby time passes, the monitor turns off automatically. Pressing any button or changing the resolution will initialize the standby time. <ul style="list-style-type: none"> • Off: The automatic standby function is turned off. • 4H: The monitor is automatically turned off after 4 hours. • 6H: The monitor is automatically turned off after 6 hours. • 8H: The monitor is automatically turned off after 8 hours.
Response Time	You can set a response time for displayed pictures based on the speed of the screen. For a normal environment, it is recommended that you use Middle . For a fast-moving picture, it is recommended that you use High . Setting to High may cause image sticking. <ul style="list-style-type: none"> • Off: The response time is turned off. • High: Sets the response time to High. • Middle: Sets the response time to Middle. • Low: Sets the response time to Low.

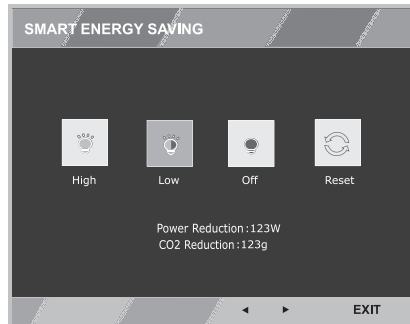
SMART ENERGY SAVING



- 1 Press  button on the bottom of the Monitor to display the **SMART ENERGY SAVING** OSD.
- 2 Set the options by pressing the ◀ or ▶ buttons.
- 3 Select **EXIT** to leave the OSD menu.

Each option is explained below.

- **High:** Enables SMART ENERGY SAVING you can save energy with this energy- high efficient function.
- **Low:** Enables SMART ENERGY SAVING you can save energy with this energy- low efficient function.
- **Off:** Disables SMART ENERGY SAVING.
- **Reset:** Resets the values of total energy consumption reduction and CO2 emission reduction estimates.

! NOTE

- Saving Data depends on the Panel. Values will be different from each panel and panel vendor.

Picture Mode

PC Mode

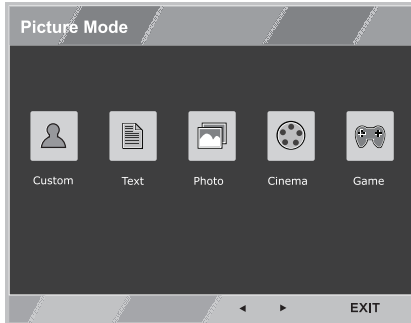

AV Mode

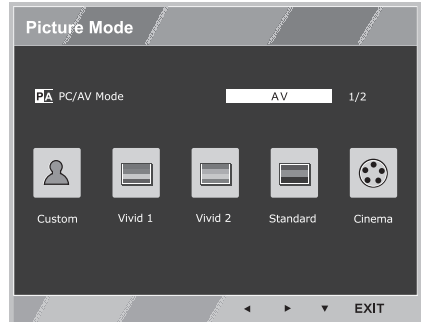

- 1 Press **MODE** button on the bottom of the Monitor set to display the **Picture Mode** OSD.
- 2 Set the options by pressing the ◀ or ▶ buttons.
- 3 Select **EXIT** to leave the OSD menu.

Each option is explained below.

Picture Mode	Description
PC Mode	<ul style="list-style-type: none"> • Custom: Allows the user to adjust each element. The color mode of the main menu can be adjusted. • Text: Optimizes the screen for document processing. • Photo: Optimizes the screen to view photos. • Cinema: Optimizes the screen to improve the visual effects of a video. • Game: Optimizes the screen for gameplay.
AV Mode (Only for HDMI input)	<ul style="list-style-type: none"> • Custom: Allows the user to adjust each element. The color mode of the main menu can be adjusted. • Vivid 1: Optimizes the screen for vivid visual effects. • Vivid 2: Optimizes the screen for more vivid visual effects. • Standard: Optimizes the screen to display normal picture quality. • Cinema: Optimizes the screen to improve the visual effects of a video.

TROUBLESHOOTING

No image is displayed.

Problem	Action
Is the product power cord connected?	<ul style="list-style-type: none"> Check if the power cord is correctly plugged into the power outlet.
Does the "Invalid Format" message appear?	<ul style="list-style-type: none"> The signal from the PC (Graphics card) is out of the vertical or horizontal frequency range of the product. Adjust the frequency range by referring to the Specifications in this manual.
Does the "No Signal" message appear?	<ul style="list-style-type: none"> The signal cable between PC and product is not connected. Check the signal cable.

The Unknown Product message appears when the product is connected.

Problem	Action
Did you install the driver?	<ul style="list-style-type: none"> Check if the Plug and Play function is supported by referring to the graphics card user manual.

The screen image looks abnormal.

Problem	Action
Is the screen position wrong?	<ul style="list-style-type: none"> Check if the graphics card resolution and frequency are supported by the product. If the frequency is out of range, set to the recommended resolution in the [Control Panel] → [Display] → [Setting] menu. (The settings may differ depending on your operating system.)
The screen is displayed abnormally.	<ul style="list-style-type: none"> The proper input signal is not connected to the signal port. Connect the signal cable that matches with the source input signal.

After-image appears on the product.

Problem	Action
After-image appears when the product is turned off.	<ul style="list-style-type: none"> • If you use a fixed image for a long time, the pixels may be damaged. Use the screen-saver function. • When a dark image is displayed on the screen after an image with high contrast (black and white or gray), this may cause image sticking. This is normal for LCD screen products.

Screen color is abnormal.

Problem	Action
Screen has poor color resolution (16 colors).	<ul style="list-style-type: none"> • Set the number of colors to more than 24 bits (true color). Select [Control Panel] → [Display] → [Settings] → [Color Table] in Windows. (The settings may differ depending on your operating system.)
Screen color is unstable or mono-colored.	<ul style="list-style-type: none"> • Check the connection status of the signal cable. Or, re-insert the PC graphics card.
Do black spots appear on the screen?	<ul style="list-style-type: none"> • Several pixels (red, green, blue, white, or black color) may appear on the screen, which can be attributable to the unique characteristics of the LCD panel. This is not a malfunction of the LCD.

The operation does not work normally.

Problem	Action
The power suddenly turned off.	<ul style="list-style-type: none"> • Is the Timer set? • Check the power control settings. Power interrupted.
Touch does not respond when the desktop is extended to a second touch monitor.	<ul style="list-style-type: none"> • In Windows 7 and Windows 8, you can configure the second monitor as the touch screen as shown below. <ul style="list-style-type: none"> - (Control Panel → Hardware and Sound → Tablet PC Settings → Setup → Setup and click the screen of the second touch monitor)

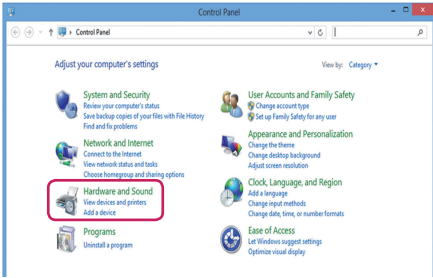

Control Panel → Hardware and Sound

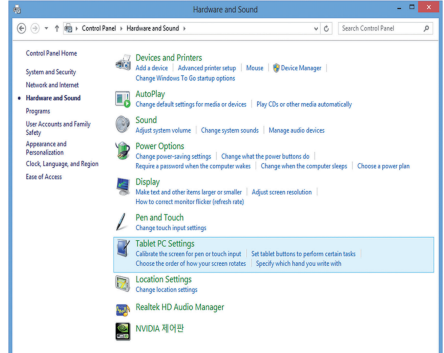

Tablet PC Settings

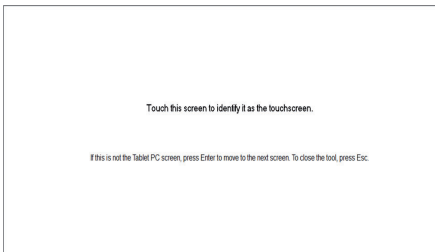

Setup and click the screen of the second touch monitor

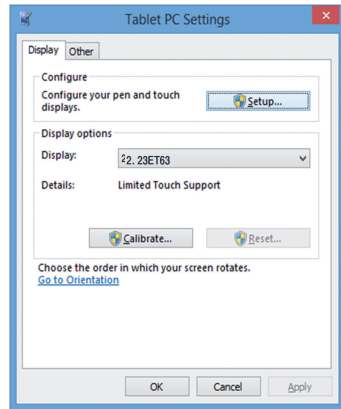

Setup

⚠ CAUTION

- Image sticking does not occur when using constantly changing images but may occur when using a fixed image for an extended period of time. Therefore, it is recommended that you use the instructions below to decrease the likelihood of image sticking occurring when using a fixed image. It is recommended that you change the screen at least once every 12 hours at the very minimum; if done more frequently, the prevention of image sticking is more effective.

Recommended operating conditions

- 1 Change the background and the character colors using the same time interval.



When changing colors, using complementary colors helps to prevent image sticking.

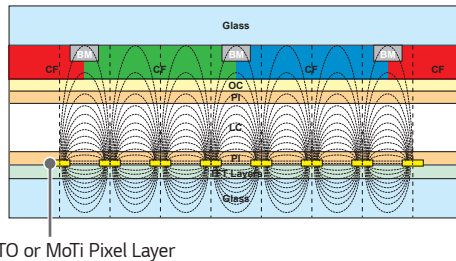

- 2 Change the image using the same time interval.



Make sure that the characters or images before changing the image remain in the same location after changing the image.

What is image sticking?

When the LCD panel displays a static image for an extended period of time, it can cause a voltage difference between the electrodes that operate the liquid crystals. When the voltage difference between the electrodes builds up over time, liquid crystals have a tendency to remain aligned in one direction. During this process, a previously displayed image remains visible. This phenomenon is referred to as image sticking.

PRODUCT SPECIFICATIONS

The product specifications below may be changed without prior notice due to upgrade of product functions.
 “~” refers to alternating current (AC), and “—” refers to direct current (DC).

LCD screen	Screen type	Thin Film Transistor (TFT) Liquid Crystal Display (LCD) Screen Diagonal length of the screen: 58.42 cm (23 inches)
Video signal	Maximum resolution	D-Sub (Analog): 1920 x 1080 @ 60 Hz HDMI : 1920 x 1080 @ 60 Hz - This may not be supported on some OS or graphics card types.
	Recommended resolution	1920 x 1080 @ 60 Hz - This may not be supported on some OS or graphics card types.
	Horizontal frequency	30 kHz to 83 kHz
	Vertical frequency	D-Sub: 56 Hz to 75 Hz HDMI: 56 Hz to 61 Hz
	Synchronization	Separate Sync. / Digital
Input/output ports		USB UP, HDMI IN, D-SUB IN, H/P

23SE3TE		
LCD screen	Pixel pitch	0.2652 mm x 0.2652 mm
Power	Rated power	DC 19 V $\overline{\text{---}}$ 1.2 A
	Power consumption	On Mode: 25 W (Typ.) Sleep Mode: \leq 0.3 W Off Mode: \leq 0.3 W
Environmental Conditions	Operating Temperature	10 °C to 35 °C (50 °F to 95 °F)
	Operating Humidity	10 % to 80 %
	Storage Temperature	-20 °C to 60 °C (-4 °F to 140 °F)
	Storage Humidity	5 % to 90 %
AC/DC adaptor	Type ADS-40SG-19-3 19025G, manufactured by SHENZHEN HONOR ELECTRONIC or Type ADS-40FSG-19 19025GPG-1, manufactured by SHENZHEN HONOR ELECTRONIC or Type ADS-40FSG-19 19025GPBR-1, manufactured by SHENZHEN HONOR ELECTRONIC or Type ADS-40FSG-19 19025GPI-1, manufactured by SHENZHEN HONOR ELECTRONIC or Type ADS-40FSG-19 19025GPCU-1, manufactured by SHENZHEN HONOR ELECTRONIC or Type ADS-40FSG-19 19025GPB-2, manufactured by SHENZHEN HONOR ELECTRONIC or Type LCAP21, manufactured by LIEN CHANG ELECTRONIC ENTERPRISE or Type LCAP26-A, manufactured by LIEN CHANG ELECTRONIC ENTERPRISE or Type LCAP26-E, manufactured by LIEN CHANG ELECTRONIC ENTERPRISE or Type LCAP26-I, manufactured by LIEN CHANG ELECTRONIC ENTERPRISE or Type LCAP26-B, manufactured by LIEN CHANG ELECTRONIC ENTERPRISE or Type PSAB-L203A, manufactured by LG Innotek Co.,Ltd or Type PSAB-L202B, manufactured by LG Innotek Co.,Ltd or Type PSAB-L202C, manufactured by LG Innotek Co.,Ltd or Type PSAB-L202D, manufactured by LG Innotek Co.,Ltd	
Dimensions (Width x Height x Depth) /Weight		55.5 cm x 33.8 cm x 5.3 cm / 3.9 kg (21.8 inches x 13.3 inches x 2.0 inches / 8.5 lbs)

RGB TIMING

Display Modes (Resolution)	Horizontal Frequency(kHz)	Vertical Frequency(Hz)	Polarity(H/V)	
720 x 400	31.468	70.08	-/+	
640 x 480	31.469	59.94	-/-	
640 x 480	37.5	75	-/-	
800 x 600	37.879	60.317	+/+	
800 x 600	46.875	75.0	+/+	
1024 x 768	48.363	60	-/-	
1024 x 768	60.023	75.029	+/+	
1152 x 864	67.500	75.000	+/+	
1280 x 1024	63.981	60.02	+/+	
1280 x 1024	79.976	75.035	+/+	
1680 x 1050	65.290	59.954	-/+	
1920 x 1080	67.50	60	+/+	Recommend Mode

HDMI TIMING

Display Modes (Resolution)	Horizontal Frequency(kHz)	Vertical Frequency(Hz)	HDMI
480p	31.5	60	0
576p	31.25	50	0
720p	37.5	50	0
720p	45	60	0
1080i	33.75	60	0
1080p	56.25	50	0
1080p	67.5	60	0 (Recommend Mode)

! NOTE

- Vertical Frequency: In order to display an image, the screen must be refreshed dozens of times per second like a fluorescent lamp. The number of times the screen is refreshed per second is called vertical frequency or refresh rate and is represented by Hz.
- Horizontal Frequency: The time it takes to display one horizontal line is called the horizontal cycle. The number of horizontal lines displayed in one second can be calculated by dividing one by the horizontal cycle. This is called horizontal frequency and is represented by kHz.



Make sure to read the Safety Precautions before using the product.

The model and serial numbers of the SET are located on the back and one side of the SET. Record it below should you ever need service.

MODEL _____

SERIAL _____

To obtain the source code under GPL, LGPL, MPL, and other open source licenses, that is contained in this product, please visit <http://opensource.lge.com>.

In addition to the source code, all referred license terms, warranty disclaimers and copyright notices are available for download.

LG Electronics will also provide open source code to you on CD-ROM for a charge covering the cost of performing such distribution (such as the cost of media, shipping, and handling) upon email request to opensource@lge.com.

This offer is valid for a period of three years after our last shipment of this product. This offer is valid to anyone in receipt of this information.

Temporary noise is normal when powering ON or OFF this device.