



# OWNER'S MANUAL

# LG LED Screen

---

Please read this manual carefully before operating your set and retain it for future reference.

LAA015FL7B1

LAA015FL7B2

LAA015FL9B1

LAA015FL9B2

# TABLE OF CONTENTS

## **SAFETY PRECAUTIONS .....3**

- Precautions for the AC Adapter and Power .....4
- Precautions for Moving the Product.....6
- Precautions for Installing the Product .....7
- Precautions for Cleaning the Product.....9
- Precautions for Using the Product.....10
- Precautions for Using the Remote control.....12
- Precautions for Experiencing Image Retention  
.....13
- Product Disposal.....13

## **ASSEMBLY AND PREPARATION 14**

- Parts and Buttons.....15
- Storage Method for Panel Protection.....17
- Installation Precautions Guide.....18
- Installation Location.....20

## **REMOTE CONTROL ..... 22**

## **MAKING CONNECTIONS..... 24**

- Connecting to a PC.....24
- External Device Connection.....24
- Using the Input List .....26
- Daisy Chain Monitors .....26

## **TROUBLESHOOTING ..... 27**

## **PRODUCT SPECIFICATIONS..... 28**

## **LICENSES..... 31**

**WARNING** - This equipment is compliant with Class A of CISPR 32. In a residential environment this equipment may cause radio interference.

## SAFETY PRECAUTIONS

The Safety Precautions are intended to prevent unexpected danger or harm by helping the user to use the product safely and for its intended purpose.

 **WARNING**

If you ignore the warning message, you may be seriously injured or there is a possibility of accident or death.

 **CAUTION**

If you ignore the caution message, you may be slightly injured or the product may be damaged.

 **WARNING**

This product cannot be installed outdoors. Only use the product indoors as installed by the installer.

## Precautions for the AC Adapter and Power

### WARNING

- Use only the power cord or AC adapter provided or approved by LG Electronics, Inc. If you use another power cord, make sure that it is certified by the national standards. If the power cable is faulty in any way, please contact the manufacturer or the nearest authorized service center for a replacement.
- Operate the display only from a power source (i.e. voltage) indicated in the product specification.
  - Otherwise the product can be damaged, fire can occur or you may be electrocuted. If you are not sure what type of power supply you have, consult a certified installation company.
- Make sure the power cord connect to a properly grounded outlet.
  - If you do not you may be electrocuted or injured or the product can be damaged.
- Insert the power plug or AC adapter firmly so it cannot come loose.
  - Poor connection may cause a fire or electric shock.
- In the presence of thunder and lightning, never touch the power cord and signal cable because it can be very dangerous.
  - It can cause electric shock.
- Be careful not to step or place heavy objects (electronic appliances, clothing, etc.) on the power cord or AC adapter. Additionally, do not bend or pull out the power cord or AC adapter with excessive force.
  - Damaged power cords may cause a fire or electric shock.
- Do not connect power cord or AC adapter damaged with sharp objects to power outlet.
  - You may be electrocuted.
- Do not insert a conductor (like a metal chopstick) into one end of the power cord while the other end is connected to the input terminal on the wall. Additionally, do not touch the power cord right after unplugged.
  - You may be electrocuted.
- Do not use with a multi-outlet connected by many electrical product and heating devices. Use an exclusive multi-outlet with a grounding terminal.
  - A fire can break out due to overheating.

- If water or any foreign substance goes inside the product, disconnect the power cord immediately and contact the service center.
  - Otherwise, this may cause a fire or electric shock due to damage to the product.
- Keep the power cord or AC adapter away from any heating devices.
  - The cord coating may melt and cause fire or electric shock.
- Never disassemble, repair or modify the power cord or AC adapter.
  - This may cause a fire or electric shock.
- Please make sure the main power cutoff device is power cord and the product is installed near the wall outlet that is easily accessible.
- As long as this unit is connected to the AC wall outlet, it is not disconnected from the AC power source even if the unit is turned off.
- Power consumption will be '0' only when the power plug is unplugged.
- Use an appliance coupler as a disconnect device.

### CAUTION

- If the outlet, pins of the power plug, or AC adapter is covered with dust, be sure wipe and keep clean.
  - Overheating due to layers of dust may cause a fire or electric shock.
- If the outlet, pins of the power plug, or AC adapter is covered with water, be sure wipe and keep clean. Additionally, Do not touch the power plug or AC adapter with wet hands.
  - This may cause an electric shock.
- Do not turn the product on or off by plugging in or unplugging the power plug from the power outlet. It means do not use the power plug as a switch.
  - This may cause an electric shock or product malfunction.
- Do not unplug the power cord while the product is in use.
  - Electrical shock can damage the product.

## Precautions for Moving the Product

### **WARNING**

- Contact the service center before moving the product.
  - It may cause electric shock and damage the product.
- Make sure the product is turned off, unplugged, and all cables have been removed before the product is moved.
  - You may be electrocuted or the product can be damaged.
- When moving the product, Do not shock the product and impact on the front panel of the product.
  - You may be electrocuted or the product can be damaged.
- Comply with the number of people according to weight of product. (Under 25 kg (55.1 lbs) per person, use the equipment when exceed 100 kg (220.4 lbs)
  - If use the damaged product again, contact the service center because it can cause electric shock or fire.
- Do not hold it upside down while holding only the stand. (It is for stand supported models only.)
  - This may cause stand warping, panel damage and other types of product damage.

### **CAUTION**

- Do not dispose the product-packing box. It may be used put the product in the box when carrying it.

## Precautions for Installing the Product

### WARNING

- Contact the service center before installing the product.
  - It can cause electric shock and damage the product.
- Do not drop an object on or impact on the product. Keep out of reach of children and do not place toys or objects near the product to prevent throwing things on the product screen.
  - It can cause injury to human, problem to product and damage the display.
- Do not put heavy objects on, or hang from, the product.
  - If the product collapses or is dropped, you may be injured.
- Do not touch the surface of product to overheat.
  - It can cause injury to human.
- Install the product firmly fixed on a floor, wall, etc. to prepare against external impact such as wind and earthquake.
  - You must refer to the manual provided.
- Prevent Children from climbing or hanging on the product.
  - If the product collapses or is dropped, you may be injured.
- Do not install it where there are heating devices such as electrical heaters or lighting equipment.
  - Fire, electrical shock, malfunction may occur.
- Do not install this product by yourself as you may injure yourself or cause damage to product. Please contact service engineer authorized by service center.
- Do not install this product on a wall if it could be exposed to oil or oil mist.
  - This may damage the product and cause it to fall.
- Do not leave the power or signal cable, etc. on the pathway.
  - This could cause a trip or fall, which can be caused electrical shock, fire, product breakdown, or injury.
- Do not let the product drop when connecting it to an external device connected with a short cable.
  - This may cause injury and damage to the product.
- If you dropped the product or the case is broken, turn off the product and unplug the power cord and contact the service center.
  - If you continue to use without taking proper measures, electrical shock or fire can occur.
- Install the product in a dry place where it is not near dust and water. Avoid high temperatures and humidity.
  - This may cause electrical shock, fire or product damage.
- Safely install the product in a place that can hold the weight of the product.
  - A lack of strength may cause the product to fall.
- Take a comfortable and natural position to relax the muscles when working with a product.

 **CAUTION**

- Install the product where no Electromagnetic Interference occurs.
- If you install the product in a place that does not meet the recommended conditions, this may cause serious damage to the product's picture quality, life cycle, and appearance. Please check with service engineer before installing. Please do not install the product in places such as where there is an abundance of fine dust or oil mist, chemical substances are used, exposed to direct sunlight, the temperature is very high or low, the humidity is very high.
- Make sure the product is well ventilated by installing at a distance (100 mm (3.9 inches) or more) from the wall.
  - If you install the product too close to the wall, it may be deformed or fire can break out due to internal heat buildup.
- Do not cover the product with tablecloth or curtain or other material (eg. plastic) while plugged in to block the ventilation hole of the product.
  - The product can be deformed or fire can break out due to overheating inside the product.
- Do not install the product in an area with poor ventilation (e.g. on a bookshelf, in a closet) or outside and avoid placing on cushions or carpets.
  - The product could catch fire due to overheating inside the product.
- Install the product on a flat and stable place that is large enough to support the product.
  - If the product is dropped, you may be injured or the product may be broken.
- When installing the product on a shelf or cabinet, make sure that the bottom end of the product is not protruding forward.
  - The product may fall due to unbalanced center of gravity, which may cause personal injury or damage to the product. Be sure to use cabinets or shelves that fit your product.

## Precautions for Cleaning the Product

### WARNING

- Keep the product clean at all times.
  - If you don't clean the unit for a long time and it becomes covered in dust, it can cause fire or product damage.
- When you need to clean the inside of the product, you must contact the service center.
  - Otherwise, cleaning without support may cause a fire, electric shock, or damage to the product.
- When cleaning the product, unplug the power cord and wipe gently with a soft cloth to prevent scratching.
  - An electric shock may occur or damage to the screen as get a scratch.
- When you want to clean the front frame, spray water onto a soft cloth 2 to 4 times and wipe in one direction only.
  - Too much moisture may cause staining.
- Do not physically come in contact with the screen of the LED Package.
  - This may cause damage to the product.
- To clean the product, use an air gun to lightly remove dust from the front frame and the screen.
  - If there are foreign substances in between the LEDs on the screen, it may cause a defect in the screen.

### CAUTION

- When cleaning the product or the screen, unplug the power cord and wipe it gently with a soft cloth. Do not spray water or other liquids directly on the product. Especially, do not clean your product with chemicals including glass cleaner, any type of air freshener, insecticide, lubricants, wax (car, industrial), abrasive, thinner, benzene, alcohol, etc., which can damage the product or its panel.
  - This may result in fire, electric shock or product damage (deformation, corrosion or breakage).

## Precautions for Using the Product

### **WARNING**

- Do not use the product in any environment with excessively high temperatures or humidity.
- If you use the product for a long period of time, take a rest from time to time to protect your vision.
  - Extended viewing could result in impaired vision.
- Listening at high volume or using for a long time can cause damage to your hearing.
- In the event that liquid or a foreign object falls into the product, please switch it off and unplug it from the wall outlet and contact the service center.
  - Otherwise, the product may cause fire or electric shock.
- In the event that no image appears on the screen or no sound is heard, stop using the product. Switch it off immediately, unplug it from the power outlet and contact the service center.
  - Otherwise, the product may cause fire or electric shock.
- Do not drop an object or impact on the product or screen.
  - It can cause injury to human, problem to product and damage the screen.
- If you can smell smoke or other odors or hear a strange sound, unplug the power cord and contact the service center.
  - If you continue to use the product without taking proper measures, it may cause electrical shock or fire.
- Do not attempt to disassemble, repair or modify the product yourself. Please contact service center if you need to repair it.
  - Fire or electric shock can occur.
- Do not place objects filled with liquids, such as vases, cups, etc. on over of the product to prevent liquid from entering the product.
  - Failure to do so may result in fire, electric shock, malfunction or deformation.
- Do not push hard on or scratch the product's surface with your hands or sharp objects, such as nails, pencils or pens. Do not shock or scratch the front and sides of the screen with metallic objects.
  - This may damage the products and cause it to malfunction.
- Do not touch the product if it has been exposed to sunlight or an intense light because it could be hot.

- Do not use high voltage electrical goods near the product (e.g., a bug zapper).
  - This may result in product malfunction if it receives an electrical shock.
- If there is a gas leak, do not touch the outlet, and open the windows for ventilation.
  - Otherwise, the product may cause fire or electric shock.
- If you dropped the product or the case is broken, turn off the product and unplug the power cord.
  - If you continue to use without taking proper measures, electrical shock or fire can occur. Contact the service center.
- Keep small accessories out of the reach of children.
  - If a child swallows it, consult a doctor immediately.
- Keep out of reach of children from the product. Also, do not throw toys or objects at the product or screen.
  - It can cause injury to human, problem to product and damage the screen.
- All the power sources must be disconnected by removing the power cables to remove all power from the unit.

### CAUTION

- This panel is an advanced product that contains millions of pixels. You may occasionally see pixel spots when viewing the screen. Since these deactivated pixels are not a defect, the performance and reliability of the product is not affected.
- Do not put or store inflammable substances near the product.
  - There is a danger of explosion or fire.
- Keep the proper distance from the product.
  - It can cause damage to your vision if you look at the product too closely.
- Set the appropriate resolution and frequency by products.
  - It can cause damage to your vision.
- Take a regular break when working with the product for a long time.

## Precautions for Using the Remote control

### **WARNING**

- Avoid places with high humidity.
  - It may cause electrical shock or damage the product.
- Do not expose batteries to excessive heat, such as direct sunlight, open fireplace, and electric heaters.
  - It may cause fire and you may be injured.
- Make sure that children do not swallow the remote control batteries when you replace them. Keep batteries out of reach of children.
  - If a child swallows a battery, consult a doctor immediately.
- Do not dispose of batteries in a fire.
  - Please dispose batteries at a local recycling center or a retail store that handles batteries.
- Used batteries, which include rechargeable batteries, should be recycled separately from waste.
  - Please dispose used batteries and rechargeable batteries at a local recycling center or a retail store that handles batteries.

### **CAUTION**

- Do not short circuit and disassemble of batteries.
  - It may cause electrical shock or fire.
- The remote control may not function properly in sunlight or under a strong lamp. Move the product if it is being used in these conditions.
- Check if there is any obstacle between the product and the remote control.
- Do not mix new batteries with old batteries.
  - Overheating or leaking batteries may cause fire or electric shock.
- Only use the specified type of battery. Do not insert batteries that are not rechargeable into the charger.
  - Overheating or leaking batteries may cause fire or electric shock.

## Precautions for Experiencing Image Retention

- Displaying a still image for a prolonged period of time may cause damage to the screen, resulting in image retention. Most third-party products have the same issue. The resulting damage is not covered by the product warranty.
  - Use a screen saver when using the monitor for a prolonged period of time.

## Product Disposal

- Do not dispose of this product with general household waste.
- Disposal of this product must be carried out in accordance to the regulations of your local authority.

# ASSEMBLY AND PREPARATION

## CAUTION

- Always use genuine components to ensure safety and product performance.
- The product warranty will not cover damage or injury caused by the use of counterfeit components.
- Connect the power cord to the product before you plug it into a wall outlet. Plugging the power cord into a wall outlet first may cause an electric shock, which can also damage the product.
- The warranty will not cover any damage caused by using the product in an excessively dusty environment.

## NOTE

- The accessories provided with your product may vary depending on the model or region.
- Product specifications or contents in this manual may be changed without prior notice due to upgrade of product functions.
- SuperSign Software & Manual
  - Downloading from the LG Electronics website.
  - Visit the LG Electronics website <http://partner.lge.com> and download the latest software for your model.

## How to use the ferrite core

- 1 Use the ferrite core to reduce the electromagnetic interference in the power cable. Wind the power cable on the ferrite core once.
- 2 Place the ferrite core close to the monitor.

## Parts and Buttons

### LAA015FL7B1, LAA015FL9B1

The image may be different according to the model.

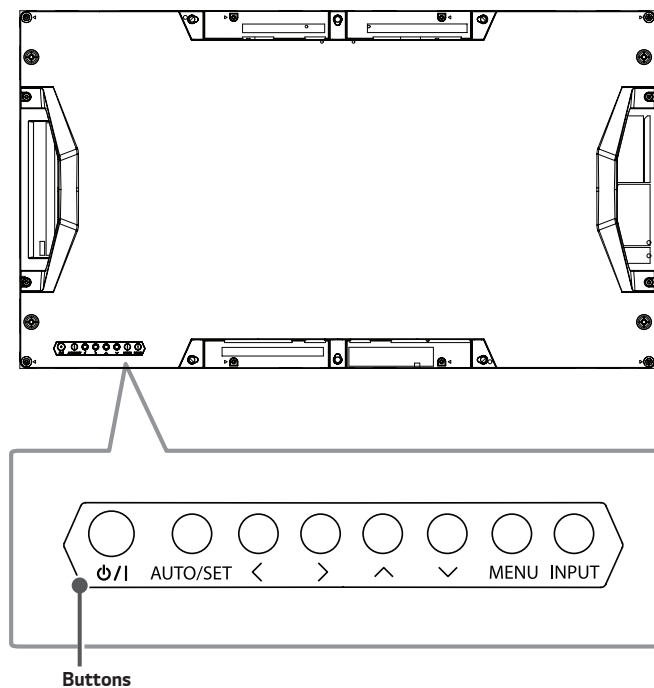

- **⏻/⏻**: Turns the power on or off.
- **AUTO/SET**: Displays the current signal and mode.
- **<>**: Moves left and right.
- **^ v**: Adjust the up and down.
- **MENU**: Accesses the main menus, or saves your input and exits the menus.
- **INPUT**: Changes the input source.

**LAA015FL7B2, LAA015FL9B2**

The image may be different according to the model.

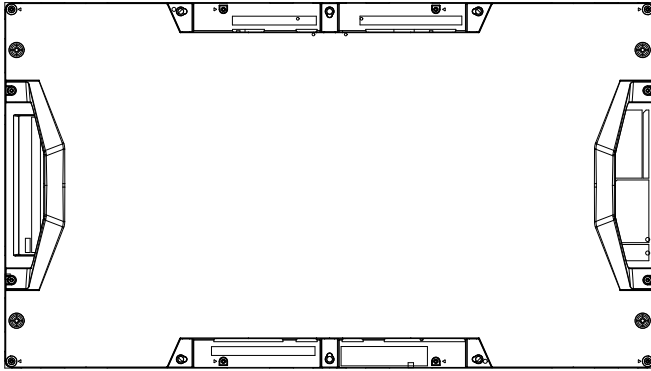

## Storage Method for Panel Protection

### Correct Method

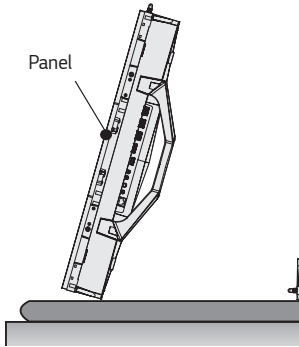

If the product needs to be set upright, hold both sides of the product, and tilt backward carefully. Do not let the panel touch the floor.

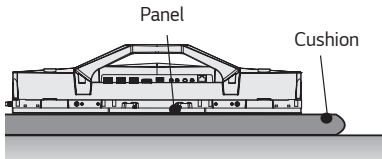

When laying down the product, lay a cushion on a flat floor. Put the product on it with the panel of the product facing down.

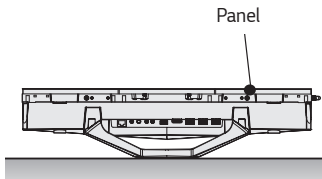

If there is not a cushion available, ensure the floor is clean and then lay the product down carefully with the panel facing upward. At this time, be careful for objects not to fall on the panel.

### Incorrect Method

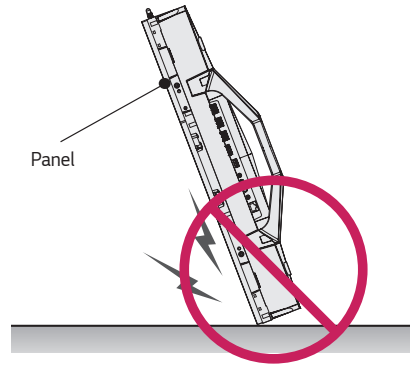

If the product is tilted onto the bezel, the bottom of the panel may be damaged.

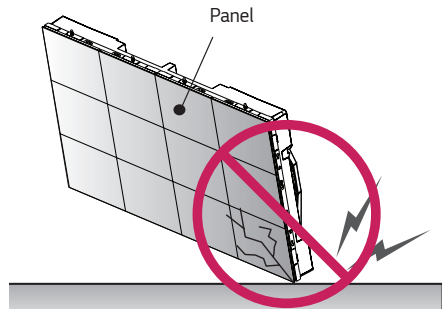

If the product is tilted onto the edge of the panel, the panel may be damaged.

## Installation Precautions Guide

### Temperature

- Make a cooling system for the enclosure so that the operating temperature of the product can be maintained.
  - Product operating temperature: 0 °C to 40 °C (32 °F to 104 °F)  
(the recommended room temperature is below 25 °C (77 °F).)
- Install in a location where the warm air from an air conditioner does not directly affect the product.
  - This will prevent malfunctions such as the screen turning off.

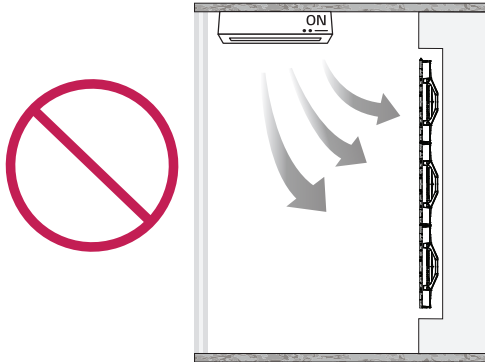

### Direct Sunlight

- Install in a location that is not exposed to direct sunlight.
  - This will prevent the screen from appearing blurry due to light reflection.

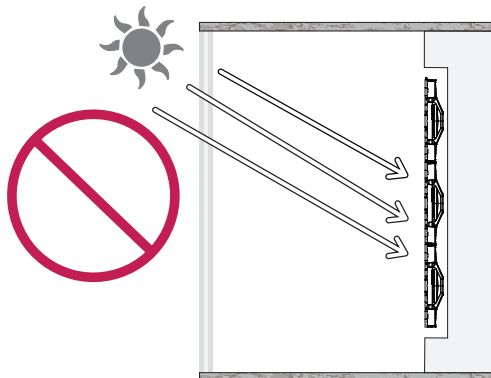

**Installation Position**

- Ensure the distance from the ceiling of the installation room to the product is at least 400 mm (15.7 inches).
  - The high temperature air collected at the ceiling will naturally circulate to prevent malfunction.
- Ensure the distance from the floor of the installation room to the product is at least 100 mm (3.9 inches).
  - The air from the floor will easily circulate to the ceiling to prevent malfunctions.

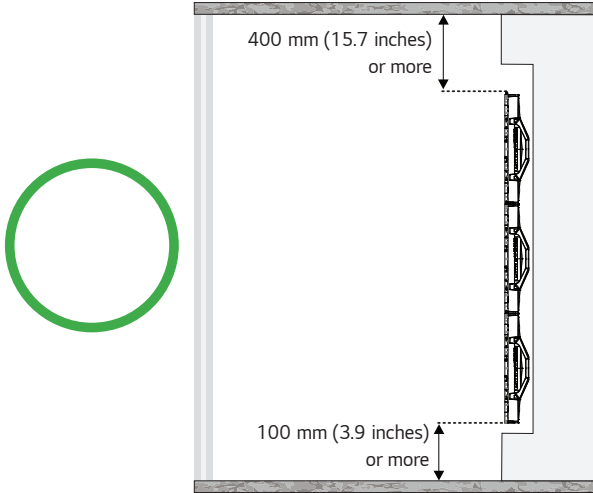

## Installation Location

### Installing on a Recessed Wall

- After installation on a recessed wall, a bezel can be installed for interior purposes.

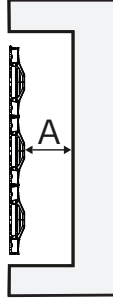
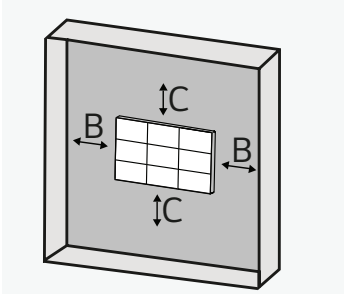

A : 100 mm (3.9 inches) or more

B : 25 mm (0.9 inches) or more

C : 60 mm (2.3 inches) or more

### When Installing the Bezel

- Ensure it can be detached for product repair.
- For the top / bottom bezels, secure at least 60 % of the air vent to facilitate air circulation.
  - This will prevent malfunction.

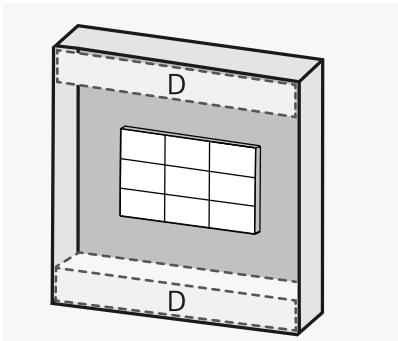

D : Air Vent  
(60 % or more)

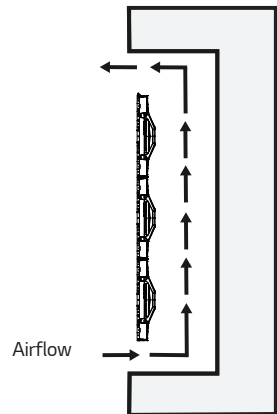

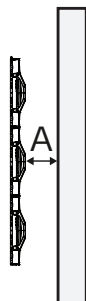
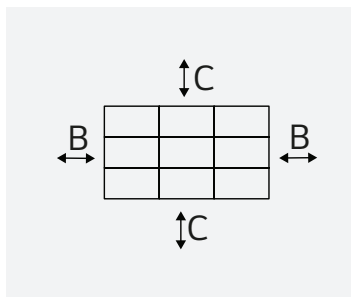
**Installing on a Wall**

A : 100 mm (3.9 inches) or more

B : 25 mm (0.9 inches) or more

C : 60 mm (2.3 inches) or more

# REMOTE CONTROL

The descriptions in this manual are based on the buttons on the remote control. Please read this manual carefully to use the monitor correctly. To install batteries, open the battery cover, place batteries (1.5 V AAA) matching ⊕ and ⊖ terminals to the labels inside the compartment, and close the battery cover. To remove the batteries, perform the installation actions in reverse. The illustrations may differ from the actual accessories.

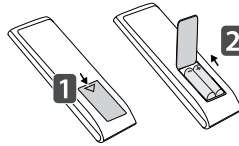

## ⚠ CAUTION

- Do not mix old and new batteries, as this may damage the remote control.
- Be sure to point the remote control toward the remote control sensor on the monitor.
- Some features of the remote control may not be supported in certain models.
- The product's internal and external batteries should not be exposed to excessive heat such as direct sunlight, fire, or the like.

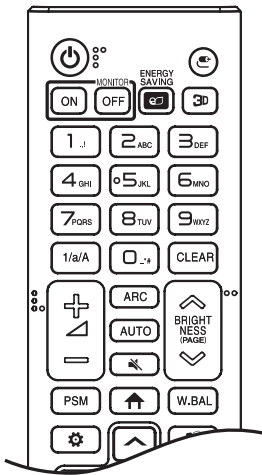

**⏻ (POWER)** Turns the monitor on or off.

**MONITOR ON** Turns the monitor on.

**MONITOR OFF** Turns the monitor off.

**ENERGY SAVING** Reduces power consumption by adjusting peak screen brightness.

**⏻ (INPUT)** Selects the input mode.

**3D** Turns the display layout pattern on.

**1/a/A** Toggles between numerical and alphabetical.

**Number and Alphabet buttons** Enters numerical or alphabetical characters depending upon the setting.

**CLEAR** Deletes the entered numerical or alphabetical character.

**△ Volume Up/Down Button** Adjusts the volume.

**ARC** Selects the Aspect Ratio mode.

**AUTO** Automatically adjusts picture position and minimizes image instability (available for RGB input only).

**🔇 (MUTE)** Mutes all sounds.

**BRIGHTNESS** Adjusts the brightness of the display.

**PAGE** The function is not supported in this model.

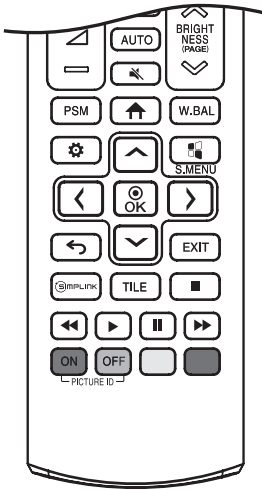

**PSM** Selects the Picture Mode.

**HOME** Activates the Launcher.

**W.BAL** Enters the White Balance menu.

**SETTINGS** Accesses the main menus or saves your input and exit menus.

**S.MENU** SuperSign menu key.

**Navigation Buttons** Scrolls through menus or options.

**OK** Selects menus or options and confirms your input.

**BACK** Allows you to move back one step in the user interaction function.

**EXIT** Quit all OSD tasks and applications.

**SIMPLINK** Allows you to control various multimedia devices to enjoy multimedia simply by using the remote control through the Simplink menu.

**TILE** Selects the TILE Mode.

**PICTURE ID ON/OFF** When the Picture ID number matches the Set ID number, you can control whichever monitor you want in multi-display format.

**USB Menu Control Buttons** Controls media playback. (May not be supported on some models.)

# MAKING CONNECTIONS

You can connect various external devices to your monitor. Change the input mode and select the external device you want to connect. For more information about external device connections, see the user manual provided with each device.

## Connecting to a PC

Some of the cables are not provided. This monitor supports the Plug and Play\* feature.

\* Plug and Play: a feature that enables a PC to recognize devices attached by the user without device configuration or user intervention when powering up.

## External Device Connection

Some of the cables are not provided. Connect a HD receiver, DVD, or VCR player to the monitor and select an appropriate input mode.

For the best picture and sound quality, connecting external devices to your monitor using HDMI cables is recommended.

**! NOTE**

- For the best image quality, using the monitor with HDMI connection is recommended.
- To comply with the specifications of the product, use a shielded interface cable with ferrite core, such as a HDMI cable.
- If you turn the monitor on when the set is cold, the screen may flicker. This is normal.
- Sometimes red, green, or blue spots may appear on the screen. This is normal.
- Use a High Speed HDMI®/TM cable (shorter than 3 meters (9.84 ft)).
- Use a certified cable with the HDMI logo attached. If you do not use a certified HDMI cable, the screen may not display or a connection error may occur.
- Recommended HDMI Cable Types
  - High Speed HDMI®/TM Cable
  - High Speed HDMI®/TM Cable with Ethernet
- If you cannot hear any sound in HDMI mode please check your PC settings. Some PCs require you to manually change the default audio output to HDMI.
- If you want to use HDMI-PC mode, you must set your PC/DTV to PC mode.
- You may experience compatibility issues if you use HDMI-PC mode.
- Make sure the power cable is disconnected.
- If you connect a gaming device to the monitor, use the cable provided with the gaming device.
- High Speed HDMI®/TM cables transmit a HD signal up to 1080p and higher.
- When connecting an external audio device, use a device with audio amplifier.

**⚠ CAUTION**

- Do not press the screen with your finger for a prolonged period as this may result in temporary distortion on the screen.
- Avoid displaying static images on the screen for a long period of time to prevent image retention. Use a screensaver if possible.
- A wireless communication device near your monitor can affect the image.

## Using the Input List



- HDMI1 → HDMI2 → HDMI3 → DISPLAYPORT

## Daisy Chain Monitors

To use multiple products, first connect an external device to the product, connect one end of the supported signal input cable to the OUT connector of the product, and then connect the other end to the IN connector of the product you wish to connect to.

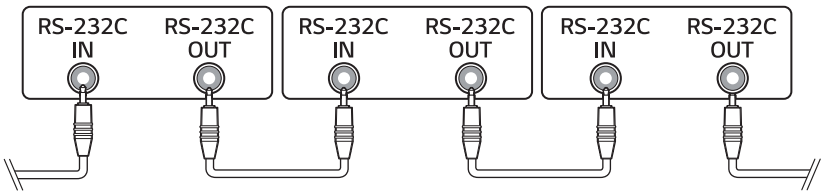

### ! NOTE

- If the signal cable between the product and your PC is too long, make sure to use a Booster or optical cable.
- Daisy chaining the video output may be limited depending on the performance of the input device that supports HDCP.

# TROUBLESHOOTING

## No image is displayed.

- Is the power cord connected to the product?
  - Check if the power cord is correctly plugged into the power outlet.
- Did you install the driver?
  - Check if the Plug and Play function is supported by referring to the graphics card user manual.

## Issues Related to Screen (Video)

- Is the screen position wrong?
  - Check if the graphics card resolution and frequency are supported by the product. If the frequency is out of range, set to the recommended resolution in the display settings in control panel.
- The screen is displayed abnormally.
  - The proper input source is not connected to the port. Connect a cable that matches the input source signal.

## Issues Related to Screen (Color)

- After-image appears when the product is turned off.
  - If you display a still image on the screen for a long time, the LED package may be damaged rapidly. Use the screen-saver function.
  - When a dark image is displayed on the screen after an image with high contrast (black and white or grey), this may cause image sticking. This is normal for LED products.
- Screen has poor color resolution (16 colors).
  - Set the color depth to more than 24 bits (true color).
- Screen color is unstable or mono-colored.
  - Check the connection status of the signal cable. Or, re-insert the PC graphics card.

## Other Issues

- The power suddenly turned off.
  - Check if the auto-off function is activated on the settings related time.
  - Power source has not being supplied properly. See if the product power cord is connected properly.

# PRODUCT SPECIFICATIONS

The product specifications below may be changed without prior notice due to upgrade of product functions.  
 “~” refers to alternating current (AC), and “—” refers to direct current (DC).

Pixel pitch (distance between pixels)		1.5 mm
Resolution		640 x 360 - LDM Resolution: 160 x 120
Environmental Conditions	Operating Temperature	0 °C to 40 °C (32 °F to 104 °F)
	Operating Humidity	10 % to 80 %
	Storage Temperature	-20 °C to 60 °C (-4 °F to 140 °F)
	Storage Humidity	5 % to 85 %

## LAA015FL7B1, LAA015FL9B1

Video signal	Maximum resolution	3840 x 2160 @ 30 Hz - This may not be supported on some OS or graphics card types.
	Recommended resolution	1920 x 1080 @ 60 Hz - This may not be supported on some OS or graphics card types.
	Horizontal frequency	30 kHz to 83 kHz
	Vertical frequency	30 Hz, 56 Hz to 60 Hz
	Synchronization	Separate Sync, Digital
Input/ Output ports		HDMI IN, DP IN, USB 2.0 IN, AUDIO OUT, RS-232C IN/OUT, IR IN, LAN IN, DATA OUT, AC IN/OUT
Embedded battery		Applied

\* DP Cable: Use a DP cable that is certified to a DP 1.1a (SST) standard or higher.

**LAA015FL7B1, LAA015FL9B1**

Power	Rated Voltage	AC 100-240 V ~ 50/60 Hz 9.0 A / 9.0 A
	Power Consumption	On Mode: 410 W (Max.) Sleep Mode: ≤ 0.5 W Standby Mode: ≤ 0.5 W
Dimensions (Width x Height x Depth) / Weight	960 mm x 540 mm x 128.5 mm / 20.85 kg (37.7 inches x 21.2 inches x 5.0 inches / 45.9 lbs)	

**LAA015FL7B2, LAA015FL9B2**

Power	Rated Voltage	AC 100-240 V ~ 50/60 Hz 9.0 A / 9.0 A
	Power Consumption	On Mode: 390 W (Max.) Sleep Mode: ≤ 0.5 W Standby Mode: ≤ 0.5 W
Dimensions (Width x Height x Depth) / Weight	960 mm x 540 mm x 128.5 mm / 19.24 kg (37.7 inches x 21.2 inches x 5.0 inches / 42.4 lbs)	

**HDMI/ DisplayPort (PC) Support mode**

Resolution	Horizontal frequency (kHz)	Vertical frequency (Hz)
800 x 600	37.879	60.317
1024 x 768	48.363	60
1280 x 720	44.772	59.855
1366 x 768	47.7	60
1280 x 1024	63.981	60.02
1680 x 1050	65.29	59.954
1920 x 1080	67.5	60
3840 x 2160	67.5	30

**HDMI/ DisplayPort (DTV) Support mode**

Resolution	Horizontal frequency (kHz)	Vertical frequency (Hz)
480/60p	31.5	60
576/50p	31.25	50
720/50p	37.5	50
720/60p	45	60
1080/50i	28.1	50
1080/60i	33.75	60
1080/50p	56.25	50
1080/60p	67.432	59.94
1080/60p	67.5	60
2160/30p	67.5	30

**! NOTE**

- When the cable is connected to the HDMI or the DisplayPort, you can select the PC/DTV mode optionally. It is recommended that you select PC mode when connecting to a PC and select DTV mode when connecting to other devices. The DTV mode refers to all modes excluding the PC mode.
- Vertical frequency: The product display functions by the screen image changing dozens of times every second like a fluorescent lamp. The vertical frequency or refresh rate is the number of image displays per second. The unit is Hz.
- Horizontal frequency: The horizontal interval is the time taken to display one horizontal line. When 1 is divided by the horizontal interval, the number of horizontal lines displayed every second can be tabulated as the horizontal frequency. The unit is kHz.

# LICENSES

Supported licenses may differ by model. For more information of the licenses, visit [www.lg.com](http://www.lg.com).



The terms HDMI and HDMI High-Definition Multimedia Interface, and the HDMI Logo are trademarks or registered trademarks of HDMI Licensing Administrator, Inc. in the United States and other countries.

Manufactured under license from Dolby Laboratories. Dolby, Dolby Vision, Dolby Audio, Dolby Atmos, and the double-D symbol are trademarks of Dolby Laboratories.

For DTS patents, see <http://patents.dts.com>. Manufactured under license from DTS Licensing Limited. DTS, the Symbol, & DTS and the Symbol together, DTS 2.0 Channel, DTS 2.0+Digital Out, DTS-HD, and DTS Virtual:X are registered trademarks or trademarks of DTS, Inc. in the United States and/or other countries. © DTS, Inc. All Rights Reserved.





The model and serial number of the product are located on the back and on one side of the product. Record them below in case you ever need service.

MODEL

SERIAL NO.

**Supplier's Declaration of Conformity**

Trade Name	LG
Responsible Party	LG Electronics USA, Inc.
Address	111 Sylvan Avenue, North Building, Englewood Cliffs, NJ 07632
E-mail	lg.environmental@lge.com

Temporary noise is normal when powering ON or OFF this device.



USER MANUAL

LG Digital

Signage

(MONITOR SIGNAGE)

Please read this manual carefully before operation and retain it for future reference.

webOS 4.0

# CONTENTS

## SETTINGS .....4

- Home.....	4
Global Buttons	
Dashboard	
[Content Manager]	
- Ez Setting .....	5
[Video Wall]	
[On/Off Scheduler]	
[SI Server Setting]	
[Server Setting]	
[Fail Over]	
[Status Mailing]	
[Play via URL]	
[Setting Data Cloning]	
[Sync Mode]	
[Multi Screen]	
[LG ConnectedCare (Signage 365 Care)]	
[LG Business Cloud]	
[Office Meeting Mode]	
- General.....	15
[Language]	
[System Information]	
[Set ID]	
[Time & Date]	
[Power]	
[Network]	
[Safety Mode]	
[Advanced Setting]	
- Display .....	29
[Picture Mode]	
[Aspect Ratio]	
[Rotation]	

[Advanced Setting]	
Video Output Resolution	
- How to Set the Screen Protection Mode.....	37
Step 1: Set [Screen Protection Mode Setting]	
Step 2: Configure the [Network] (when using the video wall mode)	
- Sound .....	42
[Sound Mode]	
[Sound Out]	
[Audio Out]	
[AV Sync Adjustment]	
[Digital Audio Input]	
- Admin.....	45
[Lock Mode]	
[Change Password]	
[Enterprise Settings]	
[HDCP Dynamic output control]	
[Factory Reset]	

## CONTENT MANAGER ..... 47

- Web Login.....	47
- Content Manager .....	47
[Player]	
[Scheduler]	
[Editor]	
- Group Manager 2.0 .....	54
- ScreenShare.....	57
- LG Presenter.....	58
Connect	
Screen Share	
Handover	

**MANAGEMENT TOOLS..... 61**

- Control Manager.....61
- Picture ID.....62

**TOUCH ..... 63**

- Touch Assistive Menu.....63

**TO CONTROL AN EXTERNAL PC  
USING TOUCH SCREEN ..... 64**

- Connecting to a PC.....64
- Prioritized Tasks on the Touch Screen.....64

**SMART CALIBRATION ..... 65**

- How to Run.....65
- [Manual Calibration]

**IR CODE ..... 67****CONTROLLING MULTIPLE  
PRODUCTS..... 69**

- Connecting cables.....69
- Communication Parameter .....70
- Command Reference List.....71
- Transmission/Reception Protocol .....75

To obtain the source code that is contained in this product, under GPL, LGPL, MPL, and other open source licenses that have the obligation to disclose source code, and to access all referred license terms, copyright notices and other relevant documents, please visit <https://opensource.lge.com>.

LG Electronics will also provide open source code to you on CD-ROM for a charge covering the cost of performing such distribution (such as the cost of media, shipping, and handling) upon email request to [opensource@lge.com](mailto:opensource@lge.com).

This offer is valid to anyone in receipt of this information for a period of three years after our last shipment of this product.





## ! NOTE

- Software-related content may be changed without prior notice due to upgrades of the product functions.
- Some features described in the User Manual may not be supported in certain models and countries.
- SNMP 2.0 is supported.

# SETTINGS

## Home

### Global Buttons

-  [Position]: Navigate to the OSD Output Position Selection screen.
-  [MOBILE URL]: Provides information necessary to access the monitor set through an external device's browser. With this feature, you can view QR code and URL information. In addition, by accessing the URL, you can also run Content Manager and Group Manager 2.0, and Control Manager. (This featured is optimized for Google Chrome.)
-  [Input]: Navigate to the external input selection screen
-  [Setting]: Navigate to the Settings screen
- **FREEZE**: Freezes the screen with the external input image at the moment of key input. This is a LAEC (AIO) only function. (The function may be canceled when switching to some apps. Ex) Other external input apps, multi screen, dsmp, si app, player, etc.)

### Dashboard

- This feature displays key information about your Signage monitor in the center of the home screen. In the Dashboard, you can manually change settings by selecting the corresponding items.
-  [Manual Download]: Downloads a manual by scanning a QR code.

## ! NOTE

- If the dashboard is locked, the focus does not move.
- Depending on the QR Code app on your mobile device, you may not be able to access the page. (Use the address provided to access the manual download page.)

## [Content Manager]

- [Player]: Play a variety of content including images, videos, and SuperSign content.
- [Scheduler]: Manage schedules for content that will be played at different times.
- [Editor]: You can create your own content using templates and media files.
- [Group Manager 2.0]: Distribute content schedules and setting data to the connected device.

## Ez Setting

### [Video Wall]

**SETTINGS** /  → [Ez Setting] → [Video Wall]

Set Video Wall options to create a wide visual canvas.

- [Tile Mode]: Turn [Tile Mode] on or off.
- [Tile Mode Settings]: Display a single integrated screen on multiple Signage monitors.
- [Natural Mode]: Display the image excluding the area that overlaps with the monitor's bezel so that the image displayed has a more natural feel to it.
- [Frame Control]: Adjust the sets that run [Scan Inversion] and frame deviation.
  - When running [Scan Inversion], please run [Frame Control] for the sets that do not run [Scan Inversion].
- [Scan Inversion]: Reduce screen deviation between adjoining video walls by changing screen scanning method.
- [White Balance]: Configure white balance settings (White Pattern, R/G/B-Gain, and Backlight).
- [Reset]: Reset to initial settings.
- [Reboot to Apply]: Reboot the set to configure a changed Frame Control/Scan Inversion value.

#### **NOTE**

- When Tile Mode is enabled, automatically set [Frame Control] for odd numbered rows and [Scan Inversion] for even numbered rows.

### [On/Off Scheduler]

**SETTINGS** /  → [Ez Setting] → [On/Off Scheduler]

Set a schedule to use your signage by time and day of the week.

- [On/Off Time Setting]: Set on/off times for each day of the week.
- [Holiday Setting]: Set holidays by date and by day of the week.

### [SI Server Setting]

**SETTINGS** /  → [Ez Setting] → [SI Server Setting] → [SI Server Setting]

Set up to connect your signage to an external SI server. Set up a server environment for SI app installation.

**SETTINGS** /  → [Ez Setting] → [SI Server Setting] → [Developer Mode & Beanviser]

This feature provides great convenience to the app developers.

Set up to install and activate the Developer mode and BEANVISER app.

## ! NOTE

- To use these features, an account (ID/PASSWORD) for webOS Signage developer website (<http://webossignage.developer.lge.com/>) is required.

## [Server Setting]

**SETTINGS / ⚙️** → [Ez Setting] → [Server Setting]

Set up to connect your signage to a SuperSign server.

- CMS Server
- Control Server

## [Fail Over]

**SETTINGS / ⚙️** → [Ez Setting] → [Fail Over]

Set the priority of the input devices when a fault occurs. Automatically play the content stored in the device or run the set app.

- [On/Off]: Turns [Fail Over] on or off.
- [Input Priority]: Set the priority of input sources for fail over.
- [Backup via storage]: When there is no input signal, this feature automatically plays the content stored in the device or runs the set app. When set to [On], [Auto], [Manual], [SuperSign Contents] items are activated.
  - [Auto]: When the automatic input switches due to taking screenshots of an image or video that is playing at regular intervals, this feature will play back the file. (OLED model is not supported.)
    - > Capture time Interval: The time interval can be set to 30 min, 1 hour, 2 hours and 3 hours.
  - [Manual]: When the automatic input switches due to the image and video file being uploaded, the feature will play back the file.
    - > [Backup media select]: Using the settings button, you can upload a single file in the internal / external memory.
    - > [Preview]: You can preview the uploaded file.
  - [SI App / Play via URL]: Run SI App or Play via URL when automatic input switch occurs.
    - > [SI App]: SI App behavior depends on the settings from [SI SERVER SETTING] menu in [Ez Setting].
    - > [Play via URL]: Play via URL behavior depends on the settings from [Play via URL] menu in [Ez Setting].
    - > If both [Play via URL] and [SI SERVER SETTING] can be run, it runs [Play via URL] when automatic input switch occurs.
  - [SuperSign Contents]: When the automatic input switches, this feature will play the file(s) distributed in SuperSign CMS.
- [reset]: Reset to initial settings.

## ! NOTE

- Depending on the model, [SI App / Play via URL] feature not be supported.
- If multiple input devices are connected simultaneously, the input device switches automatically to the one with the highest priority among the devices with valid signal, even if a failure does not occur.

## [Status Mailing]

**SETTINGS** /  → [Ez Setting] → [Status Mailing]

This feature configures the system so that the status of the device is assessed and then notified to the administrator by e-mail.

- [On/Off]: Turns [Status Mailing] on or off.
- [Scheduled Mailing], [When a failure occurs]: Sets the email sending interval.
- [User E-mail Address]: Set the user email address of the sender.
- [Sending Server(SMTP)]: Set the address of the SMTP server.
- [ID]: Enter the account ID of the sender.
- [Password]: Enter the password for the sender's account.
- [Receiver E-mail Address]: Set the email address of the recipient.
- [Send message]: Immediately assess the status of the device and deliver the information to the specified email address.
- [reset]: Reset to initial settings.

### **NOTE**

- If the status regarding any of the following items changes or becomes abnormal, a status message can be sent.
  - 1. Temp. Sensor: If the set reaches a dangerous temperature, its current temperature is recorded, and an email containing such information is sent.
  - 2. Temp. Sensor Validation: An email is sent if there is no temperature sensor connected, if the communication status of the temperature sensor is unknown, or if the information provided by the chip provider is abnormal.
  - 3. LAN Status, WiFi Status: An email is sent when the network's connection status is changed. The maximum number of network status changes that can be saved is limited to 50. The saved value is reset once the power turns off.
  - 4. No Signal Check: Checks whether there is a signal. If there are no signals for more than 10 seconds, an email is sent.
  - 5. Schedule Play Status: An email is sent if content cannot be played between the scheduled start time and end time in either Content Management Schedule status or SuperSign Content status. However, this does not apply when terminated using the remote control.
  - 6. Fail Over Status: An email is sent in case of failure or automatic switch to the input device with the highest priority. (Input switches by the user (RC, RS232C, SuperSign) are excepted.)
  - 7. Motion Detection Status: When the product detects movement or shock caused by the external environment, an e-mail is sent to you.
  - 8. Angle Detection Status: An e-mail is sent if a change in inclination is detected in the product, such as tilting or tipping over. (Supported features may vary by model.)
- Only SMTP ports 25, 465, and 587 are supported.
- The occurrence of internal input switches, excluding external input switches (RC, RS232C, SuperSign), are considered as Fail Over Status.
- One email containing the "Failover status : Failover" message is sent when switching to Fail Over Status, and the following status emails sent regularly or upon status changes contain the message "Failover status : None"

## [Play via URL]

**SETTINGS / ⚙️** → [Ez Setting] → [Play via URL]

Play content you want to play automatically through the built-in web browser.

- [URL Loader]: Turns [Play via URL] on or off.
- [Set URL]: Enter the URL address to display automatically.
- [Preview]: Preview your desired website by accessing the specified URL.
- [Save]: Save the specified URL.
- [Reboot to Apply]: Restarts the monitor set after saving the specified URL.
- [Reset]: Reset to initial settings.

### **NOTE**

- This feature does not apply when [Screen Rotation] is enabled, and using this feature disables [Preview].
- If [Time & Date] is not set to [Set Automatically], website navigation may be difficult.
  - **SETTINGS / ⚙️** → Check [General] → [Time & Date] → [Set Automatically]

## [Setting Data Cloning]

**SETTINGS / ⚙️** → [Ez Setting] → [Settings Data Cloning]

This feature is used to copy and import the settings of the device to other devices.

- [Export Setting Data]: Export the settings of the device to another device.
- [Import Setting Data]: Import the settings of another device into the device.

## [Sync Mode]

**SETTINGS / ⚙️** → [Ez Setting] → [Sync Mode]

Sync up time and content among multiple signage.

- [RS-232C Sync]: Sync up multiple signage connected by RS-232C.
- [Backlight Sync]: Shares values to control backlights using illumination sensors between devices connected by RS-232C.
- [Network contents sync]: Sync up multiple signage connected to the same network.

## [Multi Screen]

SETTINGS / ⚙️ → [Ez Setting] → [Multi Screen]

This feature allows you to view multiple external inputs and videos on a single screen.

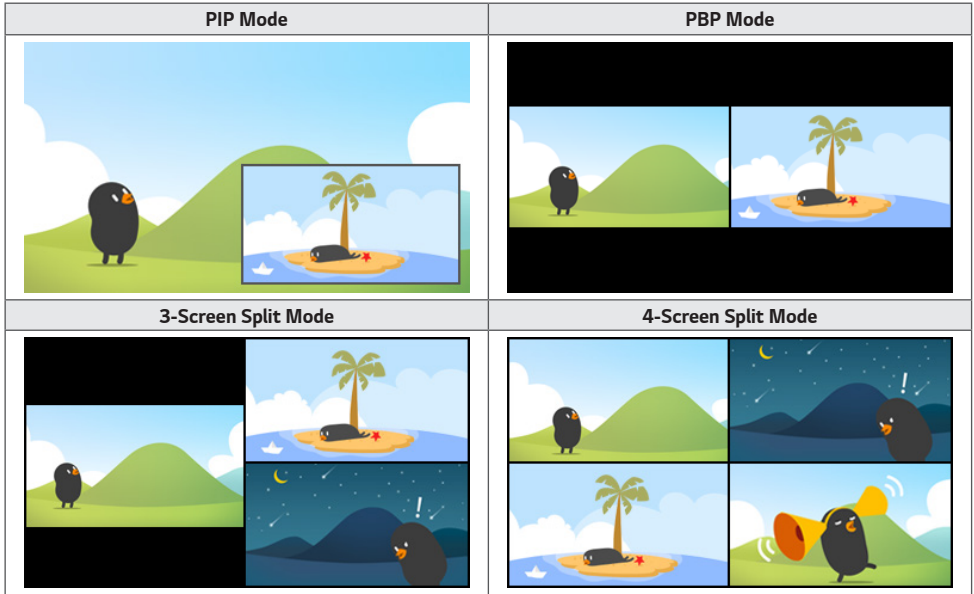



### ! NOTE

- In multi-screen mode, the DP daisy chain feature is not supported.
- The available number/shape of split screens may vary depending on the model.

### Selecting Screen Layout

When you enter multi-screen mode without having set any screen layout, the screen layout selection menu appears. When the screen layout selection menu is not displayed on the screen, go to the screen layout menu bar by pressing the up arrow key on your remote control and select your desired screen layout.

### Closing Screen Layout Menu

From the screen layout menu, press the up arrow key on the remote control to go to the screen layout menu bar and select it or press the back key to close the screen layout menu.

## Changing Screen Input

Press the  button on the top right of each split screen to select the desired input.

### ! NOTE

- Inputs which have already been selected for other split screens cannot be selected again. To select them, press the RESET button to reset the inputs for all screens first.
- The PIP mode works only when External Input Rotation is set to Off and Screen Rotation is set to Off or 180.
- In the PIP mode, supported resolutions for subscreen are as follows: Other resolutions are not supported.
  - 1680 x 1050 / 1920 x 1080
- Interlaced formats are not supported. E.g. 1080i
- This applies to both External Input/Media.
- Models with 4-screen split mode support external input resolution of 3840 x 2160 on PIP Sub screens.
- According to the model If there is no  button, enter the Change Input button in the screen configuration menu to select the screen and select the desired input.

## Playing Videos on Split Screens

Press the  button on the upper right of each split screen, select Video File, and then select a storage device to view the list of videos in the selected device. Next, select your desired video from the list to play it.

### ! NOTE

- Videos created with HEVC, MPEG-2, H.264, or VP9 codecs can be played on split screens. When using PIP mode, the following combinations cannot be used.

Main	Sub
HEVC	HEVC
H.264	HEVC
MPEG2	HEVC
VP9	VP9
H.264 4K	MPEG2
H.264 4K	VP9

- The limitations of 3 and 4-screen split are as below.

When Using 4K	It supports only up to 2 videos. A combination of max. 4K @ 60 fps + 2K @ 60 fps is available. However, H.264 4K supports max. 30 fps.	
When Using Only 2K	60fps	You can combine up to 1 MPEG2, 2 H.264, and 4 other codecs.
	30fps	You can combine up to 2 MPEG2 and 4 other codecs.

- Recommended Framerate: 24, 25, 30, 60 (including 23.9, 24.9, 29.9, 59.9)  
We do not guarantee performance when you play contents with other framerates.
- According to the model If there is no  button, enter the Change Input button in the screen configuration menu to select the screen and then select the desired video.

## [LG ConnectedCare (Signage 365 Care)]

**SETTINGS / ⚙️** → [Ez Setting] → [LG ConnectedCare (Signage 365 Care)]

You can install the LG ConnectedCare (fault diagnosis) solution for fault diagnosis and prediction service.

- [Install]: Installs the LG ConnectedCare solution.
  - 1) [ENTER ACCOUNT NUMBER]: Enters the 6-digit account number to install the LG ConnectedCare solution.
    - Account Number: The number assigned when the LG ConnectedCare solution is registered. When the account number is entered, the account name corresponding to the number is obtained.
  - 2) [CONFIRM ACCOUNT NUMBER]: Displays the account number and the account name corresponding to the account number and validates the account number.
    - If the account number is registered, the account name corresponding to the account number is displayed, and you can continue to install the LG ConnectedCare solution.
    - If the account number is not registered, "Unknown" is displayed as the account name, and you cannot continue to install the solution.
- [Enable]/[Disable]: Sets whether to Enable/Disable the LG ConnectedCare solution.
- [Account]: Displays user's currently connected account number and name.
- [Version]: Displays the version of the LG ConnectedCare solution.
- [Check for Update]: Checks for available updates in the server.
- [Update]: Updates the LG ConnectedCare solution to the latest version.
- [Server Status]: Displays the status of connection between the set and server.
  - [Connected]: Displayed when the set and server are connected.
  - [Not Connected]: Displayed when the set and server are disconnected.
  - [Waiting for Approval]: Displayed when the server is waiting for approval.
  - [Rejected]: Displayed when the server rejected the connection.
- [Reset]: Deletes the installed LG ConnectedCare solution.

## [LG Business Cloud]

**SETTINGS** / ⚙️ → [Ez Setting] → [LG Business Cloud]

You can install the [LG Business Cloud] solution for fault diagnosis and prediction service.

- [Installation Type]: Selects the type to install the [LG Business Cloud] solution.
- [Installation Code]: Installs the [LG Business Cloud] solution using the number provided by each workspace created in [LG Business Cloud].
- [Install]: Installs the [LG Business Cloud] solution.
  - 1) [ENTER INSTALLATION CODE]: Enters the 6-digit installation code to install the [LG Business Cloud] solution.
    - When the installation code is entered, the workspace information corresponding to the installation code is obtained.
  - 2) [CONFIRM INSTALLATION CODE]: Displays the installation code and the workspace information corresponding to the installation code.
    - If the installation code is registered, the workspace information corresponding to the installation code is displayed, and you can continue to install the [LG Business Cloud] solution.
    - If the installation code is not registered, "Unknown" is displayed as the workspace information, and you cannot continue to install the solution.
- [Workspace]: Displays the user's currently connected business and workspace information.
- [Version]: Displays the version of the [LG Business Cloud] solution.
- [Details]: Displays the version of supported solutions.
- [Server Status]: Displays the status of connection between the set and server.
  - [Connected]: Displayed when the set and server are connected.
  - [Not Connected]: Displayed when the set and server are disconnected.
  - [Waiting for Approval]: Displayed when the server is waiting for approval.
  - [Rejected]: Displayed when the server rejected the connection.
- [Reset]: Resets the installed [LG Business Cloud] solution.

## [Office Meeting Mode]

**SETTINGS / ⚙️** → [Ez Setting] → [Office Meeting Mode]

You can set up Quick Functions to use the product in a conference room.

- Office Meeting Mode: Turning on this feature enables you to set functions related to the conference room meeting mode.
- Meeting Guide Screen
  - Meeting Guide Screen: Turning on this feature will allow you to use the conference information screen. This feature is for outputting a background image when there is no external input. Turning on this feature turns on the [No Signal Image] feature.
  - Meeting Room Name: When the conference information screen is on, you can change the conference room name displayed on the screen or select whether or not to display the conference room name.
  - Time: When the conference information screen is on, you can select whether or not to display the current time on the screen.
- Advanced Settings
  - Auto Bright: Turning on this feature will automatically adjust the monitor screen brightness to match the surrounding environment.
  - Picture Mode: Set the same picture mode for all external input supported by this product.
  - Input Auto Switching: When an external input has been inserted, this feature automatically switches to the relevant external input. Turning on this feature ends the [Ez Setting] → [Fail Over] feature.
  - Auto Power Off: Switch the power off automatically. When this feature is turned on, the [No Signal Power Off(15Min)] and [No IR Power Off (4hour)] features will be turned on.
  - Edit Input Name: Change the name of each external input.
  - Presentation Timer: Use the presentation timer. Turning on this feature will display the [Presentation Timer] on the screen for selecting an external input.
    - > **INPUT / ** → [Presentation Timer]
    - > The time of operation can be set up to 120 minutes in intervals of ten minutes. When the time has been set, press [Start] to begin the timer.
    - > Press the yellow button on the remote control to pause the timer: When the timer is paused, the time is displayed in blue.
    - > Press the yellow button on the remote control to restart the timer.
    - > The time is displayed in red when the remaining time is less than three minutes. The time will blink when the remaining time is less than one minute.
    - > Press the blue button on the remote control to end the timer.
    - > The UI automatically disappears 10 minutes after the timer ends.
    - > The product may turn off while the timer is still in operation due to the auto-off and power saving settings.

### **NOTE**

- If the No Signal image has been downloaded, turning on [Meeting Guide Screen] will display the downloaded image first when there is no signal.
- If using the [Meeting Room Name] and [Time] items in the [Meeting Guide Screen], and if using the downloaded image as the No Signal image, it is recommended to use a brightly-colored image in accordance with the optimal resolution of the Signage model.

## General

### [Language]

**SETTINGS** / ⚙️ → [General] → [Language]

You can select the menu language to be displayed on the screen.

- [Menu Language]: Sets the language of your Signage monitor.
- [Keyboard Language]: Sets the language of the keyboard displayed on the screen.

### [System Information]

**SETTINGS** / ⚙️ → [General] → [System Information]

This feature displays information such as the device name, software version, and storage space.

### [Set ID]

**SETTINGS** / ⚙️ → [General] → [Set ID]

- [Set ID] (1-1000): Assigns a unique Set ID number to each product when several products are connected via RS-232C. Assign numbers ranging from 1 to 1000 and exit the option. You can control each product separately by using the Set ID you assigned to each product.
- [Auto Set ID]: Automatically assigns a unique Set ID number to each product when several products are connected for display.
- [Reset Set ID]: Reset the Set ID of the product to 1.

### [Time & Date]

**SETTINGS** / ⚙️ → [General] → [Time & Date]

This feature enables you to view and change the time and date on the device.

- [Set Automatically]: Set [Time] and [Date].
- [Daylight Saving Time]: Set the start and end times for Daylight Saving Time. The DST start/end times function only when you set them more than one day apart from each other.
- [NTP Server Setting]: Allows you to set other NTP servers other than the basic NTP server.
- [Time Zone]: Allows you to change the time zone based on continent, country/region, city or user settings.

## [Power]

SETTINGS / ⚙️ → [General] → [Power]

Power-related feature settings

### **[No Signal Power Off (15 Min)]**

Set whether to use the 15 Min Auto Off feature.

- You can set this option to [On] or [Off].
- If you set this feature to [On], the product turns off after it's remained in No Signal status for 15 minutes.
- If you set this feature to [Off], the 15 Min Force Off feature is disabled.
- It is recommended that you set this feature to [Off] if you intend to use the product for long periods of time as the feature turns the power of the product off.

### **[No IR Power Off (4hour)]**

Set whether to use 4 Hours Off feature.

- You can set this option to [On] or [Off].
- If you set this feature to [On] the product turns off if there is no input from the remote control for 4 hours.
- If you set this feature to [Off], the 4 Hours Off feature is disabled.
- It is recommended that you set this feature to [Off] if you intend to use the product for long periods of time as the feature turns the power of the product off.

### **[DPM] / [DPM (Standby Mode)]**

Set the Display Power Management (DPM) mode.

- If this feature is not set to [Off], the monitor will enter DPM mode when there is no input signal.
- If you set this feature to [Off], [DPM] / [DPM (Standby Mode)] is disabled.

### **[DPM Wake Up Control] / [DPM (Standby Mode) Wake Up Control]**

Turns on the set according to the digital signal processing of the connected DVI-D/HDMI port.

- When set to [Clock], the set only checks for digital clock signals and turns on once it finds the clock signal.
- When set to [Clock+DATA], the set turns on if the digital clock and data signals are both input.

**[PM Mode]**

- [Power Off (Default)]: Set the normal DC off mode.
- [Sustain Aspect Ratio]: The PC retains the Extended Display Identification Data (EDID) even when the power is off.
- [Screen Off]: Switches to [Screen Off] status when entering DPM, Auto Power Off (15 min, 4 hours), or Abnormal Shut Down mode.
- [Screen Off Always]: Switches to [Screen Off] status when entering DPM, Auto Power Off (15 min, 4 hours), Off Time Scheduling, or Abnormal Shut Down mode, or when there is input from the remote control's Power button or the monitor's Off button.
- [Screen Off & Backlight On]: Partially turns on the backlight to keep the display at a proper temperature when in Screen Off status.
- [Network Ready]: Monitor is turned off, but you can control power internally through the network.

**! NOTE**

- In order for the screen to switch from [Screen Off] to On status, there must be input from the remote control's Power or Input button, or the monitor's On button.

**[Power On Delay](0-250)**

- This feature prevents overload by implementing a power-on delay when multiple monitor sets turn on.
- You can set the delay interval in the range of 0 to 250 seconds.

**[Power On Status]**

- Select the operating status of the monitor when the main power has turned on.
- You can choose from among [PWR (Power On)], [STD (Standby)], and [LST (Last Status)].
- [PWR (Power On)] keep the monitor powered on when the main power has turned on.
- [STD (Standby)] switch the monitor to Standby status when the main power has turned on.
- [LST (Last Status)] switches the monitor back to its previous status.

**[Wake On LAN] / [Wake On LAN (Networked Standby Mode)]**

- Set whether to use [Wake On LAN] / [Wake On LAN (Networked Standby Mode)].
- You can set the feature to On or Off for each wired/wireless network.
- [Wired]: When set to [On], the [Wake On LAN] / [Wake On LAN (Networked Standby Mode)] feature is enabled, letting you turn the product on remotely through a wired network.
- [Wireless]: When set to [On], the [Wake On LAN] / [Wake On LAN (Networked Standby Mode)] feature is enabled, letting you turn the product on remotely through a wireless network.

**[Power Indicator]**

- This function enables you to change the [Power Indicator] settings.
- Setting to [On] will turn on [Power Indicator].
- Setting to [Off] will turn off [Power Indicator].
- Regardless of [On] or [Off] settings in [Power Indicator], [Power Indicator] will be turned on for approximately 15 seconds.

**[Power On/Off History]**

Display the device's power on/off history.

**[Network]**

SETTINGS / ⚙️ → [General] → [Network]

**[Wired Connection (Ethernet)]**

- **Wired Connection:** Connects the monitor to a local area network (LAN) via the LAN port and configures wired network settings. Only wired network connections are supported. After setting up a physical connection, the display will automatically connect without any adjustments on most networks. A small number of networks may require the display settings to be adjusted. For detailed information, contact your Internet provider or consult your router manual.
- **802.1X EAP:** Authentication based on IEEE 802.1X is available for wired connection. Select the desired EAP type and Phase 2 Authentication, enter the ID/Password registered with the authentication server, and press the CONNECT button to attempt the connection.

**[Wi-Fi Connection]**

If you have set your monitor up for a wireless network, you can view and connect to available wireless Internet networks.

- **[Add a Hidden Wireless Network]:** You can add a wireless network by manually typing in its name.
- **[Connect via WPS PBC]:** Press the button on the wireless router that supports PBC to easily connect to the router.
- **[Connect via WPS PIN]:** Enter the PIN number in the web page of the PIN-supporting wireless router to connect to the router in a simple manner.
- **[Advanced Wi-Fi Settings]:** You can change the settings of the connected wireless network.

**[Certificate Download]**

- Download the certificates used for 802.1X EAP stored in USB.
- Only pem file extension can be downloaded.

**! NOTE**

- On models that support Wi-Fi dongles, the Wireless Network Connection menu is enabled only when a Wi-Fi dongle is connected.
- When connected to a network that supports IPv6, you can select IPv4 / IPv6 in the wired / wireless network connection. But, IPv6 connection only supports automatic connection.

**[LAN Daisy Chain]**

- LAN Daisy Chain forms a daisy chain of LAN ports so that even if you connect only one monitor set to a network, the other sets in the daisy chain are connected to the network.
- However, the first monitor set in the daisy chain must be connected to the network through a port that is not used for the daisy chain connection.

**[SoftAP]**

If you set up a SoftAP, you can connect many devices via a Wi-Fi connection without a wireless router and use wireless Internet.

- The SoftAP and ScreenShare features cannot be used at the same time.
- On models that support Wi-Fi dongles, the SoftAP menu is enabled only when a Wi-Fi dongle is connected to the product.
- Wi-Fi Channel: You can directly select a Wi-Fi channel.
- SoftAp Access Information
  - SSID: A unique identifier necessary to make a wireless Internet connection
  - Security Key: The security key you enter to connect to the desired wireless network
  - Connected Devices Count: Shows the number of devices currently connected to your Signage device via a Wi-Fi connection. Up to 10 devices are supported.

**[UPnP]**

Open and block UDP port 1900, which is used for UPnP.

- The default setting is [On]. Setting this feature to [Off] blocks UDP port 1900, making the UPnP function unavailable.
- If you set this feature to [Off], Sync Mode's "Network" option will be deactivated. When the value for Sync Mode is "Network," the value switches to "Off," deactivating the "Network" option.
- If you change the UPnP value, the change will not be applied before a [reboot].
- If you set UPnP to [Off], you cannot use Group Manager 2.0 properly.

**[Ping Test]**

Check your network status with the ping test.

**[Port Control]**

Unused ports can be blocked for network security.

**[Connection Domain]**

Change domain for checking network connection.

**! NOTE**

- A reboot is recommended for the settings to be applied properly.

**Tips for Network Settings**

- Use a standard LAN cable (Cat5 or higher with an RJ45 connector) with this display.
- Many network connection problems during set up can often be fixed by re-setting the router or modem. After connecting the display to the home network, quickly power off and/or disconnect the power cable of the home network router or cable modem, Then power on and/or connect the power cable again.
- Depending on the Internet service provider (ISP), the number of devices that can receive INTERNET service may be limited by the applicable terms of service. For details, contact your ISP.
- LG is not responsible for any malfunction of the display or Internet connection failures due to communication errors/ malfunctions associated with your Internet connection or other connected equipment.
- LG is not responsible for problems within your INTERNET connection.
- You may experience undesired results if the network connection speed does not meet the requirements of the content being accessed.
- Some INTERNET connection operations may not be possible due to certain restrictions set by the Internet service provider (ISP) supplying your Internet connection.
- Any fees charged by an ISP including, without limitation, connection charges are your responsibility.

**NOTE**

- If you want to access the Internet directly on your display, the INTERNET connection should always be on.
- If you cannot access the Internet, check the network conditions from a PC on your network.
- When you use Network Setting, check the LAN cable or check if DHCP in the router is turned on.
- If you do not complete the network settings, the network may not function correctly.

**CAUTION**

- Do not connect a modular phone cable to the LAN port.
- Since there are various connection methods, please follow the specifications of your telecommunication carrier or INTERNET service provider.
- Network setting menu will not be available until the display connected to physical network.

### Tips for When Configuring Wireless Network Settings

- The wireless network may be affected by interference from a device that uses 2.4 GHz frequency, such as a wireless telephone, Bluetooth device or microwave. Interference may also be caused by a device that uses 5 GHz frequency such as Wi-Fi devices.
- The wireless network service may run slowly depending on the surrounding wireless environment.
- Some devices may have a network traffic jam if any local home networks are turned on.
- To connect to a wireless router, a router that supports wireless connection is necessary; the wireless connection function of the corresponding router must also be activated. Ask the router manufacturer whether the router supports wireless connection.
- To connect to a wireless router, verify the SSID and security settings of the wireless router. Please refer to the user guide of the corresponding router regarding SSID and security settings of the wireless router.
- The monitor may not work properly if network devices (wire/wireless router or hub, etc.) are incorrectly set up. Be sure to install the devices correctly by referring to their user guides before configuring the network connection.
- The connection method may vary according to the manufacturer of the wireless router.

## [Safety Mode]

**SETTINGS / ⚙️** → [General] → [Safety Mode]

Set to this function for safe performance.

### [ISM Method]

If a still image is displayed on the screen for an extended period of time, image sticking can occur. The ISM method is a feature that prevents image sticking.

#### [Mode]

- Sets the [ISM Method] mode.
- [Off]: Disable the Brightness Control function.
- [Orbiter]: To prevent afterimage on the screen, the screen location moves by 4 pixels in a regular order. (This item is inactivated when the current input is No Signal.) (It only supports the models for exterior use.)
- [White Wash]: Displays a white pattern to remove image sticking.
- [User Image]: Plays your photos or movies using a USB storage device.
- [User Video]: Plays your photos or movies using a USB storage device.

#### Repeat Daily

- [Off, Just 1 Time]: Select this mode and click Complete to run the ISM function immediately.
- [On]: Performs the ISM function for the amount of time set in duration if the still image is maintained for the period set in standby.
- [On, with moving detection]: It only applies in the [Orbiter] mode. When the still image remains for the [StandBy] time, the afterimage prevention function works for the [Duration] time.
- [On, without moving detection]: It only applies in the [Orbiter] mode. When you tap the [DONE] button, the afterimage prevention function immediately applies and operates continuously.
- [Schedule]: Enable the ISM feature from start time to end time on the set day.

#### [StandBy]

- You can set the period between 1 and 24 hours.
- This option is available only when [Repeat] is set to [Schedule].
- The ISM function is performed if the still image is maintained for the set period.

#### [Duration]

- You can select from among 1 - 10 min / 20 min / 30 min / 60 min / 90 min / 120 min / 180 min / 240 min.
- This option is available only when [Repeat] is set to [Schedule].
- The ISM function is performed for the set time.

#### [Select Day]

- You can set the date.
- This option is available only when [Repeat] is set to [Schedule].

**[Start Time]**

- Set the Start time.
- This option is available only when [Repeat] is set to [Schedule].
- You cannot set the same time for Start time and End time.

**[End Time]**

- Set the End time.
- This option is available only when [Repeat] is set to [Schedule].
- You cannot set the same time for Start time and End time.

**[Action Cycle]**

You can select from among 1 - 10 min / 20 min / 30 min / 60 min / 90 min / 120 min / 180 min / 240 min.

- This option is only available when [Orbiter] is selected.
- [Orbiter]: The screen location moves at every set interval.

**[User Image Download]**

- In order to download an image, there must be an image file in "ISM" folder on your USB storage device.
- Delete the existing images stored on internal memory before downloading a new image file.
- Supported image file formats: BMP, JPG, JPEG and PNG
- You can download up to 4 images. (The maximum resolution is 1920 x 1080.)
- If a bar image is deleted or does not exist, the default image is used. (The default image is a white background)
- This option is only available when [User Image] is selected.

**[User Video Download]**

- In order to download a video, there must be a video file in the "ISM" folder on your USB storage device.
- Delete the existing contents stored on the internal memory before downloading a new video file.
- Supported video file formats: "MP4", "AVI", "FLV", "MKV", "MPEG", "TS"
- You can download only 1 video.
- If a video is deleted or does not exist, the default video is used. (The default video is a white background image)
- This option is only available when [User Image] is selected.

**\* How to reset or delete User Image / User Video**

- Reset using **SETTINGS** /  > [Admin] > [Factory Reset]
- Open the Player app > Click "Delete" button at the top right of the screen > Delete downloaded image / video

**[Screen Fault Detection]**

- The screen fault detection feature determines whether there is an abnormality at the end of screen; R, G, and B OSDs are created in the upper left-hand corner of the panel at intervals of about one second, and then a pixel sensor checks the area.
- Setting to [On] enables the screen fault detection feature.
- Setting to [Off] disables the screen fault detection feature.

**[Advanced Setting]**

SETTINGS / ⚙️ → [General] → [Advanced Setting]

**[Beacon]**

- This option enables BLE Beacon, one of Bluetooth 4.0's features.
- Beacon Mode (On/Off Toggle): enables the Beacon feature.
- The LG Beacon/iBeacon/Eddystone Type Beacon features are supported.
- iBeacon
  - Beacon UUID (hex): Set the UUID.
    1. Field1: 4byte hex value (8 digits)
    2. Field2: 2byte hex value (4 digits)
    3. Field3: 2byte hex value (4 digits)
    4. Field4: 2byte hex value (4 digits)
    5. Field5: 6byte hex value (12 digits)
  - Major (0-65535): Sets the Major value.
  - Minor (0-65535): Sets the Minor value.
- Eddystone
  - Frame: Set UUID or URL.
- 1. Setting the UUID method
  - Beacon UUID (hex): Set the UUID.
    - 1 - Field1: 10byte hex value (20 digits)
    - 2 - Field2: 6byte hex value (12 digits)
- 2. Setting the URL method
  - URL Prefix: Sets the prefix of the URL.
  - URL Suffix: Set the suffix of the URL.
  - Play via URL URL: Enter the part of the URL that excludes the prefix and suffix.
  - URL string length is limited to 15 characters.
- [Check] button: The button used to complete and apply the Beacon settings.

**! NOTE**

- Some models do not support background screening services in iOS.
- A reboot is recommended for the settings to be applied properly.
- The UUID value is hexadecimal and the exact number of digits must be entered.
- The distance to Beacon may vary depending on the device.
- The distance to Beacon may vary depending on the application used in the device.
- The Beacon function is affected by radio waves because it employs the Bluetooth Low Energy (BLE) technology. It may not function properly if the frequency range is not around 2.4GHz.
- When you set iBeacon, LG Beacon will be set to be the same as the value of iBeacon field. But the LG Beacon setting item won't be provided separately.

**[Control Interface]**

Devices connected to the display can be controlled via the interface.

- [PC/OPS Power Control]: Enable you to control the power of PC or OPS as you turn the display on and off.
  - [Disable]: Disable [PC/OPS Power Control].
  - [Sync(On)]: Set the PC/OPS power to be turned on when the display is turned on.
  - [Sync(On/Off)]: Set the PC/OPS power to be turned on when the display is turned on and set the PC/OPS power to be turned off when the display is turned off.
- [Control Interface Selection]: Select the serial communication path between the display and the connected devices.
  - [Display]: Serial communication is available via a display RS-232C IN terminal.
  - [OPS]: Serial communication is available with the OPS installed in the display.
  - [HDBaseT]: Serial communication is available with the display via HDBaseT equipment.

**! NOTE**

- Depending on the model, it can be displayed as [PC/OPS Control].
- Depending on the supported interface, the sub-menu of [Control Interface Selection] may be different.
- The PC products that support the power control are MP500/MP700, and you have to purchase them separately if necessary.
- If you change [Control Interface Selection], the [RS-232C Sync] feature of [Sync Mode] may be restricted.

**[Background Image]**

This feature enables you to set the default background image.

- [Booting Logo Image]: Change the logo image that appears when the device boots up. If you set this option to Off, no logo image appears when the device boots up. Download or initialize an image file on the storage device.
- [No Signal Image]: Change the image that appears when there is no signal. If you set this option to Off, no image appears when there is no signal. Download or initialize an image file on the storage device.

**! NOTE**

- To download an image, an image file must exist in a folder named "LG\_MONITOR" or "lg\_monitor" in the external memory (USB).
- Supported image file formats : "BMP", "JPG"
- The maximum downloadable resolution is as follows, depending on the model.
- Signage LED models do not support the boot logo feature.
- The maximum downloadable resolution of a no-signal image is the same as the resolution of the model panel.

	Boot logo image	No signal image
Full HD	1920 x 1080	1920 x 1080
Ultra HD	1920 x 1080	3840 x 2160
86 "Ultra Stretch	1920 x 300	3840 x 600
88 "Ultra Stretch	1920 x 540	3840 x 1080

**[Input Manager]**

You can set the PC or DTV label for each external input.

**[SIMPLINK Setup]**

- When the [SIMPLINK Setup] is set to [On], you can use the SIMPLINK provided by LG Signage.
- [Device ID]: Set the ID of the device connected via CEC wiring. You can choose a value between [All] and [E].
- [StandBy]: Sets the scenarios for sending and receiving the Standby command. Detailed scenarios are as follows:

	Transmission	Reception
All	O	O
Send Only	O	X
Receive Only	X	O

**[Display power (On/Off) sync]**

(Depending on model)

(This function is only supported by the Signage box)

- This is a function to control the power of the Display connected to the HDMI OUT to be synchronized with the power of the Signage box.
- When the power of the Signage box is changed from Off to On, it turns on the Display and tries to switch the input to the Signage box screen.
- When the power of the Signage box is changed from On to Off, it turns off the Display.
- [On/Off]: Enable/Disable this function

**! NOTE**

- It is necessary to enable the CEC function on the Display

**[Crestron]**

(Depending on model)

**Crestron Connected V1**

- This function enables synchronization with applications provided by Crestron.
- Server: This menu sets the server's IP address for the network connection with the server (equipment provided by Crestron).
- Port (1024-65535): This menu sets the port for the network connection with the server. The default port number is 41794.
- IP ID (3-254): This menu sets a unique ID for synchronizing with the application.

**Crestron Connected V2**

- The connection status of the server type shall be indicated by pictures and phrases. (Disconnected, Connecting, Connected)
- Type: You can select the server type you want to connect to (Off, Control System, Virtual Control, Fusion)
- CONNECT: If you press the button once, a set tries to connect to the server and the button phrase is changed into DISCONNECT. In this case, the upper items are immutable. To disconnect and change upper items, pressing the button again is needed.
- Information for connecting with the server
  - Type: Control System
    - Server: Enter the IP information of the server
    - Port: Enter the Port information for the server
    - IP ID: A unique ID that distinguishes crestron equipment from server
  - Type: Virtual Control
    - Room ID: A unique ID that distinguishes room from server. If the IP ID is the same, but the Room ID is different, the server recognizes it as a different crestron equipment.
    - Server, Port, IP ID are the same as Control System's.

- Type: Fusion
- Method: Connection direction can be selected. (Device to Fusion, Fusion to Device)
  - Device to Fusion: How to connect from set to server
  - URL: Server URL
  - Port: Server Port
  - Fusion to Device : How to connect from server to set
- Auto Discovery: The ability to locate other Crestron equipment in the network
- SSL: Communication security with server can be established. The following items are meaningful only at SSL on
  - User, Password: When the Authentication function is turned on on the server, User and Password must be entered to connect with the server.
  - Verify Certificate: A feature that checks whether a certificate installed on a server is valid. If it is not valid, it does not connect to the server
  - Certificate Download: The certificate must be stored in the set to perform the Verify Certificate function. Only certificates with extensions .pem, .crt in the USB root directory are recognized and can be added or deleted through the menu. All certificates stored at the time of Factory Reset are deleted.

### **XiO Cloud**

- The connection status with XiO Cloud is displayed. (Disconnected, Connecting, Connected)
- CONNECT: If you press the button once, a set tries to connect to the server and the button phrase is changed into DISCONNECT. To disconnect, pressing the button again is needed.

### **[LED Controller]**

Allows a specific LED display manufacturer to remotely control some features of the linked display.

### **[USB2 to HDBaseT]**

This function transfers the data received from the USB2 terminal of the display to HDBaseT.

- [On]: Transfer the data of the device connected to USB2 to the HDBaseT equipment.
- [Off]: Receive the data of the HDBaseT equipment to Signage.



### **NOTE**

- The HDBaseT function will be temporarily interrupted when the setting is changed.

### **[Quiet Mode]**

This mode is used to reduce the noise of the fan.

Adjusted to the set fan control and brightness.

### **[LG promota]**

This feature allows connection of promota app on mobile device.

For more information on how to use it, please visit the promota website (<https://www.promota.net/>)

Autorun promota App function automatically runs promota after booting.

## **[Pointer Options]**

You can set the speed and size of the pointer that appears on the screen to your liking.

- Speed: You can set the movement speed of the pointer.
- Pointer Size: You can set the size of the pointer.

# Display

## **[Picture Mode]**

SETTINGS / ⚙️ → [Display] → [Picture Mode]

### **[Mode]**

This feature enables you to choose the optimal picture mode for your installation environment.

- [Mall/QSR], [Transportation], [Education], [Gov./Corp.]: Display the picture optimally for your installation environment.
- [General]: Display the picture at normal contrast, brightness, and sharpness.
- [Auto Power Save]: Adjust the screen brightness to reduce power consumption.
- [Expert], [Calibration]: Allow an expert, or anyone who loves picture quality, to manually tune to the best picture quality.
- [Hospital]: An image setting mode optimized for medical images.

### **! NOTE**

- The type of [Picture Mode] you can select may vary depending on the model or input signal.
- [Expert] is an option that allows a picture quality expert to fine-tune the picture quality using a specific image. Thus, it may not be effective for a normal picture.

### **[HDR]**

This feature enables you to choose the optimal picture mode for your installation environment.

- [Mall/QSR]: sharpens the image by increasing the contrast, brightness and sharpness.
- [General]: In a normal viewing environment, it opens a screen that can properly show the expressiveness and brightness of HDR.
- [Gov./Corp.]: The screen appears brighter and clearer than of the General screen.
- [Education]: Suitable picture for gameplay.

**[Customize]**

- [Backlight]: Adjust the brightness of the screen by adjusting the brightness of the backlight. The closer the value is to 100, the brighter the screen is.
- [OLED Light]: Adjusts the brightness of the LED panel to control the brightness of the screen.
- [LED Light]: Adjust screen brightness by tuning the LED Light. Higher values increase brightness.
- [Contrast]: Adjust the difference between the light and dark areas of the picture. The closer the value is to 100, the greater the difference is.
- [Brightness]: Adjust the overall brightness of the screen. The closer the value is to 100, the brighter the screen is.
- [Sharpness]: Adjust the sharpness of the edges of objects. The closer the value is to 50, the clearer and the sharper the edge becomes.
- [Color]: Soften or deepen the tints on the screen. The closer the value is to 100, the deeper the colors become.
- [Tint]: Adjust the balance between red and green levels displayed on the screen. The closer to Red 50, the redder the color will be. The closer to Green 50, the greener the color will be.
- [Color Temperature]: The higher you set the color temperature, the cooler the colors on the screen will feel. The lower you set the color temperature, the warmer the colors on the screen will feel.
- [Advanced Controls] / [Expert Controls]: Customize the advanced options.
  - [Dynamic Contrast]: Optimize the difference between the light and dark parts of the screen according to the brightness of the image.
  - [Super Resolution]: Sharpen the areas of the screen that are blurry or barely distinguishable.
  - [Color Gamut]: Select the range of colors available.
  - [Dynamic Color]: Adjust the tint and saturation of the image for a more vivid and lively display.
  - [Color Filter]: Accurately adjust color and tint by filtering a specific color area of RGB space.
  - [Preferred Color]: Adjust the skin tint, grass tint, and sky tint to your preference.
  - [Gamma]: Adjust gamma settings to compensate for the brightness of the input signal.
  - [White Balance]: Adjust the overall color fidelity of the screen to your liking. In Expert mode, you can fine-tune the picture using the Method/Pattern options.
  - [Color Management System]: Experts use the color management system when they adjust the colors by using the test pattern. The color management system allows you to make an adjustment by selecting from among 6 different color spaces (Red/Yellow/Blue/Cyan/Magenta/Green) without affecting other colors. In a normal picture, you may not notice the color changes you have made.
  - [Dynamic tone mapping]: Suitable contrast settings based on image brightness of the HDR content.

- [Picture Option]: Customize the picture options.
  - [CamSync(V-Sync)]: To reduce scanline artifacts that may occur during camera shooting. You can fine-tune the LED's output frame. Genlock, Phase Shift, and Frame Control functions cannot be used when using this function. (Supported by some LED models)
  - [Noise Reduction]: Remove randomly popping dots to make the picture look clearer.
  - [MPEG Noise Reduction]: Reduce the noise generated in the process of creating a digital video signal.
  - [Black Level]: Adjust the brightness and contrast of the screen by adjusting the black level of the screen. (Recommended settings based on input signals: Backlight 0 - 255 High, RGB 16 - 235: Low, YCbCr: Low)
  - [Real Cinema]: Optimize the video image for a cinematic look.
  - [Motion Eye Care]: Reduce eye fatigue by adjusting brightness levels and lessening blurriness based on the displayed image.
  - [LED Local Dimming]: Make the light areas of the screen lighter and the dark areas darker for maximum contrast. Setting this feature to Off may increase the monitor's power consumption.
  - [TruMotion]: Reduce image shaking and image sticking that can occur with /moving images. (If you set the [External Input Rotation], this feature is unavailable.)
- [Apply to all inputs]: Copies the current value of the detailed setting menu to the entire input, and applies only to the selected picture mode.
- [Reset]: Reset the picture settings. Because the picture settings are reset according to the monitor's picture mode, please select the picture mode before resetting the picture settings.

## [Aspect Ratio]

SETTINGS / ⚙️ → [Display] → [Aspect Ratio]

This feature enables you to change the picture size to view the picture at its optimal resolution.

- [Full Wide]: Stretch the picture to fill the screen.
- [Original]: Display the picture at its original resolution.

## [Rotations]

SETTINGS / ⚙️ → [Display] → [Rotation]

### [Screen Rotation]

- This feature rotates the screen clockwise.
- You can set this feature to Off/90/180/270.
- When set to off, this feature is deactivated.
- It is recommended that you use content designed to be used in Portrait mode.
- When the screen rotation is enabled, the PIP mode of the multi-screen is unavailable.



### NOTE

- Depending on the model, the automatic screen rotation feature may not be supported.

### [External Input Rotation]

- This feature rotates the screen clockwise.
- You can set this feature to Off/90/180/270.
- When this feature is set to On (90 or 270 degrees), as for ARC, the picture is resized to be [Full Wide].
- If [External Input Rotation] is enabled during WiDi operation, the position of the mouse cursor may not be displayed accurately.
- Please note that the degradation of picture quality that occurs when you have enabled [External Input Rotation] during the use of external input has nothing to do with the product itself.
- When External Input Rotation is set to On, Multi Screen's PIP mode is disabled.
- If External Input Rotation is enabled on models that support touch, touch may not work properly.
- To use Ultra Stretch products in optimum picture quality, please refer to the User Manual's Contents Creation & Use Guide.
- For Ultra Stretch products, content picture quality may be compromised depending on the conditions of content creation and product settings (screen split/rotate).

### [Mirror Mode]

- Set the screen to rotate 180 degrees.

## [Advanced Setting]

SETTINGS / ⚙️ → [Display] → [Advanced Setting]

### [UHD Deep Color]

If you connect an HDMI, DP, or OPS device to one of the Deep Color adjustable ports, you can select between UHD Deep Color On (6G) or Off (3G) in the UHD Deep Color settings menu.

If a compatibility issue occurs with a graphics card when the Deep Color option is set to On at 3840 x 2160 @ 60 Hz, set the Deep Color option back to Off.

- HDMI, DP, and OPS specifications may vary depending on the input port. Check the specifications of each device before connecting.
- HDMI input port 1,2 is best suited for high definition videos that are 4K@60 Hz (4:4:4, 4:2:2). However, video or audio may not be supported depending on the specifications of the external device. If this is the case, please connect the device to a different HDMI port.
- This feature may not be available on some models.

### [OLED Panel Settings]

- [Clear Panel Noise]: Correct issues that may arise on the screen when it is turned on for a long period of time.
- [Screen Protection Mode Setting]: This feature analyzes the characteristics of the image from the external input to prevent afterimages on the screen.

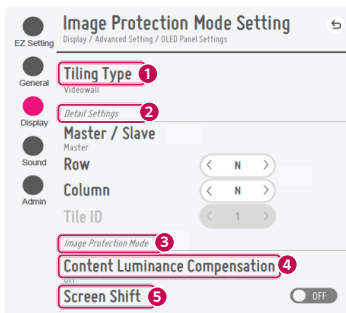
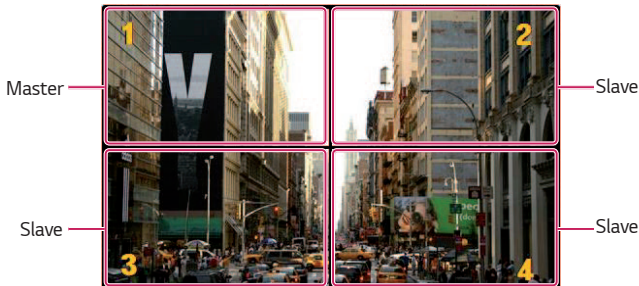

When Master is selected

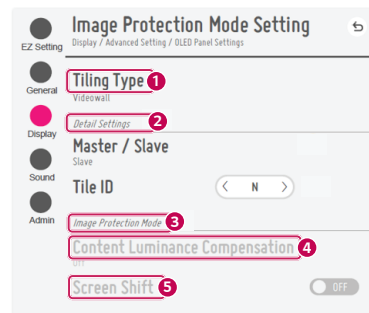

When Slave is selected

No.	Item	Description
1	[Tiling Type]	Select and set the mode according to the installation type of your Signage. <ul style="list-style-type: none"> <li>• Stand-alone: Select and use this mode when you use only one unit.</li> <li>• Video Wall: Select and use this mode when using two or more multi-screen configurations. This mode requires advanced settings.</li> </ul>
2	[Detail Settings]	Select Master or Slave. <ul style="list-style-type: none"> <li>• When Master is selected: Enter the number of rows and columns for the entire multi-screen.</li> <li>• When Slave is selected: Enter the multi-tile ID number for the individual set.</li> </ul>
3	[Screen Protection Mode]	This feature enables you to set the content correction level and to set whether to use the Screen Switch feature. <ul style="list-style-type: none"> <li>• 4 [Content Luminance Compensation]: Select a high or low correction level to use.</li> <li>• 5 [Screen Shift]: Set whether to use the Screen Switch feature.</li> </ul>

### **[Energy Saving]**

- [Smart Energy Saving]: Automatically adjust the brightness of the screen according to the brightness of the picture to save energy.
  - [On]: Enable the Smart Energy Saving feature.
  - [Off]: Disable the Smart Energy Saving feature.
- [Brightness Control]: Adjust the brightness of the screen to save energy.
  - [Auto]: Automatically adjust the brightness of the screen according to ambient light.
  - [Off]: Disable energy saving.
  - Minimum/Medium/Maximum: Use energy saving according to the energy saving level set for the monitor.
- [Brightness Range Adjustment]: Sets the min/max values of the brightness range for the backlights adjusted by the illumination sensors.
  - [Min Backlight]: Sets the min value of the backlights.
  - [Max Backlight]: Sets the max value of the backlights.
- [Brightness Scheduling]: Adjust the backlight at specified times.
  - You can set this feature to [On/Off].
  - Add schedule by setting the schedule time and backlight / OLED Light / LED Light value.
  - If the current time has not been set, [Brightness Scheduling] is disabled.
  - You can add up to six schedules, and they are sorted in ascending order by time.
  - You can edit a schedule by selecting it from the list and pressing the [OK] button.

### **! NOTE**

- Return to default settings by clicking [Admin] > [Factory Reset].

### **[Smart Brightness Compensation]**

The brightness value is adjusted to 3,000 nits, enabling continuous long-time use without brightness drops. (49/55XE4F models Only)

### **[HDMI IT Content]**

Set the HDMI IT Contents function.

- [Off]: Disable the HDMI IT Contents function.
- [On]: Enable the HDMI IT Contents function.

This feature automatically changes the monitor's picture mode based on HDMI Contents information when an HDMI signal is entered.

Even if the monitor's picture mode has been changed by the HDMI IT Contents feature, you can change the picture mode again manually.

As this has a higher priority than the picture mode set by the user, the existing picture mode may be changed when the HDMI signal changes.

### **[Color Calibration]**

Sets the screen color to match the actual color temperature.

- [Off]: Disables the Color Calibration feature. The screen color is set to the default value.
- [On]: Enables the Color Calibration feature. The screen color is set to match the actual color temperature.

#### **! NOTE**

- The screen color may change if you enable or disable the feature.
- If the Picture Mode is 'Calibration', this feature will not be available.

### **[LED Local Dimming]**

Make the light areas of the screen lighter and the dark areas darker for maximum contrast.

#### **! NOTE**

- Return to default settings by clicking [Admin] > [Factory Reset].

### **[Low Latency]**

Reduces frame delay in the LED Signage.

### **[Factory Calibration]**

Retrieves factory pixel calibration data of the LED Signage and reflects it on the screen. Calibration needs to be done once during the initial installation and should also be carried out when relocating or replacing the LDM.

### **[Genlock]**

When the Genlock signal is connected to the REF IN port and the Genlock feature is turned on, the monitor can use the video signal synchronisation feature.

- [Off] : Genlock is disabled
- [On] : Genlock is enabled

#### **! NOTE**

- Genlock setting of video source equipment is more important than Genlock of LED System Controller.
- This function may not be supported depending on the model.

**[Phase Shift]**

Phase Shift can make adjustment of LED screen output timing.

LED screen can adjust timing manually to remove visual artefacts with Phase Shift, if camera recoding result make double image(double frame).

- Range : 0~360.
  - 0: Don't use Phase Shift
  - When [Frame Control] is used :
    - \* 1 : 1/360 Frame delay added
    - \* 180 : 1/2 Frame delay added
  - When [Frame Control] is not used :
    - \* 1 : 1+1/360 Frame delay added
    - \* 180 : 1.5 Frame delay added

**! NOTE**

- Camera sync shift is more good to control visual atrefacts than LED screen. (ex: ARRI camera's Sync Shift)

10



10

Camera capture image has double frame image

Camera capture image has single frame image  
: Phase Shift can fine control

- Genlock, Phase Shift, and Frame Control can be used individually.
- The CamSync (V-Sync) function cannot be used when Genlock, Phase Shift, or Frame Control functions are used. (Supported by some LED models)
- Frame Control : When low latency mode is enabled, it can be used for matching LED screen by adding 1 frame delay. [Off]: Don't add 1 Frame delay. [On]: Add 1 Frame delay.

**! NOTE**

- This function is only supported by LED Assistant S/W
- This function will be activated when low latency mode is enabled.
- Low latency mode is enabled when external input label is set to [PC] or [Picture Mode] is set to [Education].
- [Frame Control] function may not be supported depending on the model.

**Video Output Resolution**

**SETTINGS / ⚙️** → [Display] → [Video Output Resolution]

You can set the resolution of webOS BOX.

## How to Set the Screen Protection Mode

- [Screen Protection Mode Setting]: Prevents after-images on the screen by analysing the characteristics of the external input images.
-  (SETTINGS) → [Display] → [Advanced Settings] → [OLED Panel Settings] → [Screen Protection Mode Setting]

### Step 1: Set [Screen Protection Mode Setting]

#### When using a single monitor

- 1 Video Wall Mode: Select [Standalone].
- 2 Content Brightness Correction: Select one from [Off] / [Low] / [High].
- 3 Screen Shift: Select activate or deactivate.

#### NOTE

- The [Screen Protection Mode] function is supported for external input images.
  - The [Screen Protection Mode] function is not enabled for playing images in USB devices.
  - The [Screen Protection Mode] function is not enabled when interlaces signals are input.
  - The [Screen Protection Mode Setting] menu is not supported when [External Input Rotation] is set.
  - It is recommended that you use content designed to be used in Portrait mode.
- It is recommended to use contents with 10 minutes of playback time. (The [Screen Protection Mode] function may not work smoothly for the content with the duration longer than 10 minutes.)
- For the [Screen Protection Mode] feature to work normally, the Dithering feature should be turned OFF on the external input player or the graphics chip/card you are using.
- To enable the [Screen Protection Mode] function, it needs time to recognize the pattern of the content. (The time may vary depending on the duration of the content.)

## When using the Video Wall Mode

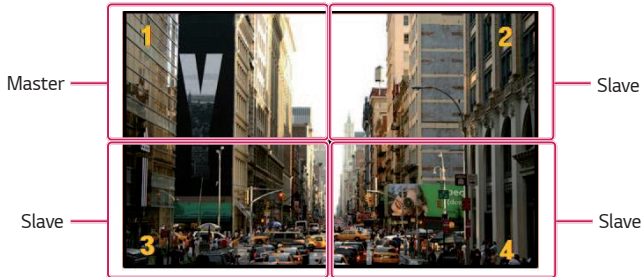

- 1 Video Wall Mode: Select [Video Wall].
  - 2 Master/Slave: Select [Master] for the upper left monitor and [Slave] for the rest.
  - 3 [Row], [Column]
    - Master Monitor: Set [Row] and [Column] using the same settings as in [Tile Mode].
    - Slave Monitor: Disable the slave monitor.
  - 4 Multi-tile ID
    - Master Monitor: Disable the master monitor (set as Tile ID 1 automatically).
    - Slave Monitor: Set Tile ID 2 and onwards in the same order as installed.
  - 5 Content Brightness Correction: Select one from [Off] / [Low] / [High].
  - 6 Screen Shift: Select activate or deactivate.
- When the settings are complete, the feature runs when DC is switched from Off to On.

## ! NOTE

- For [Screen Protection Mode] to work in the video wall, the monitors must be connected to the same network on the LAN. However, some operations may be available when [LAN Daisy Chain] is connected and used. In this case, use a router or a network switch.
- How to check the connection: Check the IP address in **⚙️ (SETTINGS)** → [General] → [Network] → [Wired Connection (Ethernet)]. For more information, refer to Step 2: Configure the [Network].

## Step 2: Configure the [Network] (when using the video wall mode)

- 1 Check the required equipment.
  - Router or network switch router
  - DHCP Server
    - Used to allocate IP addresses in the network. Included in the router.
    - Additionally required to configure the network with a network switch.
  - Network cable (Ethernet cable)
    - Used to connect the Ethernet port of the router (or network switch) and the Ethernet port of the Signage.
- 2 Check the network connection of the Signage.
  - **⚙️ (SETTINGS)** → [General] → [Network] → [Wired Connection (Ethernet)]
    - When the router is connected to the Internet: Make sure the connection status shows "Connected to Internet".
    - When the router is not connected to the Internet: Make sure the connection status shows "No Internet via Ethernet".
- 3 Check the IP address of the Signage.
  - Check the IP address in **⚙️ (SETTINGS)** → [General] → [Network] → [Wired Connection (Ethernet)].

### Examples of Network connection

- 1 When all Signage units can be connected by a single switch: Connectable without degrading the network performance.

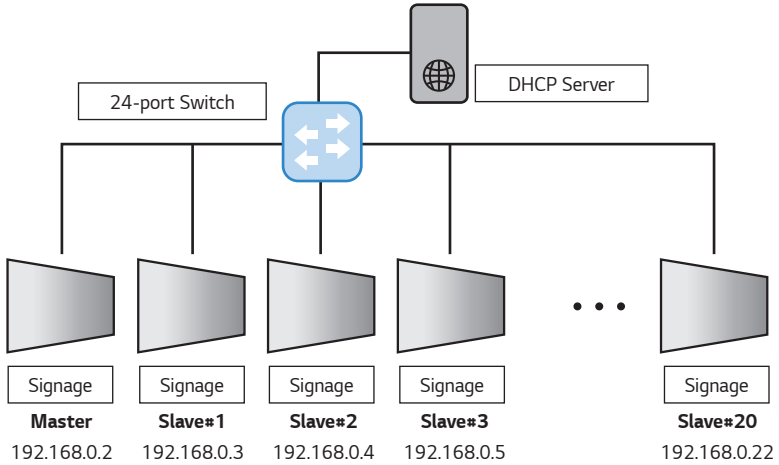

- 2 When using multiple switches: Configure the network in the 2-tier mode.

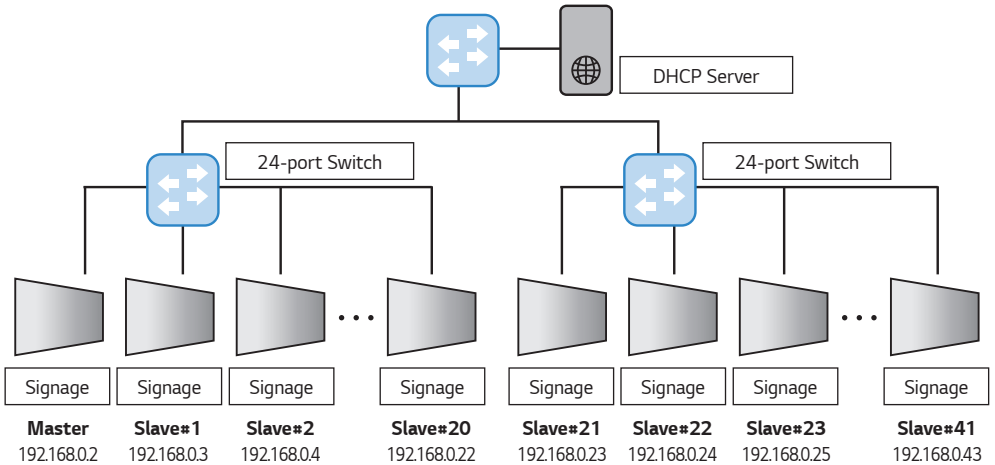

- Connect a Signage unit to each Tier-2 switch, and connect the Tier-2 switches to the Tier-1 switch.
- For the DHCP server; it is best to connect it directly to the Tier-1 switch.

**! NOTE**

- The [Tiling Type] and [Detail Settings] menu items are not available for models that do not support the tile mode.
- [Screen Protection Mode] does not work with the functions [TruMotion] / [Noise Reduction] / [MPEG Noise Reduction].
  - To enable the functions [TruMotion] / [Noise Reduction] / [MPEG Noise Reduction] in the DTV input mode, ensure that the [Screen Protection Mode] menu is set to (Off).
- To enable the [Screen Protection Mode] feature in Video Wall, the screens must be connected to the same network through a LAN.

However, some operations may not be available when the screens are connected to [LAN Daisy Chain]. In this case, we recommend using a router or network switch.
- If [Screen Protection Mode Settings] is all set and in operation, and the settings are changed or the [Screen Protection Mode] function is discontinued, the function restarts next time the product is turned on.
- The [Screen Shift] feature is supported only for the stand-alone configuration or for use in a single DP daisy chain. That is, if [Tile Mode] is enabled, the [Screen Shift] feature only works properly when the values of [Row] and [Column] in [Tile Mode Setting] are the same as those of [Row] and [Column] in [Detail Settings].
- When [Content Luminance Compensation] is set to [High], there may be differences in brightness than when it is set to [Low].
- Return to default settings by clicking [Admin] → [Factory Reset].
- When using the Screen Shift function, the location of the touched and operated area may be slightly different.

# Sound

## [Sound Mode]

SETTINGS / ⚙️ → [Sound] → [Sound Mode]

### [Sound Mode]

The best sound quality will be selected automatically depending on the video type currently being watched.

- [Standard]: This sound mode works well for content of all types.
- [Cinema]: Optimize sound for watching movies.
- [Clear Voice III] Enhance voices so they can be heard more clearly.
- [Sports]: Optimize sound for watching sports.
- [Music]: Optimize sound for listening to music.
- [Game]: Optimize sound for playing video games.

### [Balance]

- [Balance]: Adjust the output volume for the left speaker and the right speaker.

### [Equalizer]

- [Equalizer]: Manually adjust sound by using the equalizer.

### [Reset]

- [Reset]: Resets sound settings.

## [Sound Out]

**SETTINGS** /  → [Sound] → [Sound Out]

- [Internal Speaker] / [External Speaker]: You can output audio either through your Signage monitor's internal speaker or through an external speaker connected to it.
  - [Use Speaker Sound]: Enables you to turn the speaker on and off. If you are using an external audio device, turning off this feature allows you to play sound through the external audio device only.
- [SIMPLINK External Speaker]: This function connects Home Theater device by SIMPLINK. When it is set to Home Theater device input, it outputs voice through the connected device. This option is activated when SIMPLINK has been set to On.
- [LG Sound Sync / Bluetooth]: Enables you to connect Bluetooth audio devices or Bluetooth headsets wirelessly to your monitor so that you can enjoy richer audio conveniently.
- [Optical]: applied only to the models with digital optical sound output ports. You can output audio through external speaker audio devices connected to the digital audio output port.

### **NOTE**

- Some recently connected devices may automatically attempt to reconnect to the Signage monitor when it is turned on.
- It is recommended that you set LG audio devices that support LG Sound Sync to LG TV mode or LG Sound Sync mode before connecting.
- Press Device Selection to view the devices that are or that can be connected and connect other devices.
- You can use the signage remote control to adjust the volume of the connected device.
- If the audio device fails to connect, check that it is switched on and available for connection.
- Depending on the type of the Bluetooth device, the device may not connect correctly or an abnormal behavior may occur such as unsynchronized video and audio.
- Sound may stutter or sound quality may be reduced if:
  - The Bluetooth device is too far from the Signage monitor.
  - There is an obstructing object between the Bluetooth device and the Signage monitor.
  - The Bluetooth device is used together with radio equipment such as a microwave oven or wireless LAN.

## [Audio Out]

**SETTINGS / ⚙️** → [Sound] → [Audio Out]

- [Off]: Disables the use of [Audio Out]. (No audio outputted.)
- [Variable]: You can specify an output range for the external audio device connected to the monitor and adjust the volume within the range. You can change the volume of an external audio device within the range of 0 to 100 (the same as the Signage speaker volume). However, there may be a difference in the actual volume level outputted.
- [Fixed]: Sets a fixed audio output level for the external audio device.
  - If there is no external input, no external audio is outputted.
  - The variable audio output level 100 is the same as the fixed audio output level.

## [AV Sync Adjustment]

**SETTINGS / ⚙️** → [Sound] → [AV Sync Adjustment]

This feature adjusts audio timing to synchronize video and audio.

- [External Speaker] (0~15): Adjust the sync between video and audio coming from external speakers, such as those connected to the digital audio output port, LG audio equipment, or headphones. The larger the number is, the slower the voice output is than the default value.
- [Internal Speaker] (0~15): Adjust the sync of sound from the internal speakers. The larger the number is, the slower the voice output is than the default value.
- [Bypass]: Output the broadcast signals or the sound from external devices without any audio delay. Audio may be outputted earlier than video due to the processing time for video that is inputted into the monitor.

## [Digital Audio Input]

**SETTINGS / ⚙️** → [Sound] → [Digital Audio Input]

This feature enables you to choose an input source for audio output.

- [Digital]: Output the audio contained in the digital signal inputted from the connected digital input source (HDMI, DISPLAYPORT, OPS).
- [Analog]: Output audio from the digital input source (HDMI, DISPLAYPORT, OPS) connected to the monitor through the Audio In port.

# Admin

## [Lock Mode]

SETTINGS / ⚙️ → [Admin] → [Lock Mode]

## [Home Dashboard Lock]

When you set the Home Dashboard Lock, you can limit the change in the settings of the Home Dashboard.

## [USB Lock]

This feature enables you to configure the USB lock feature so that settings or content cannot be changed.

## [OSD Lock]

This feature enables you to configure the OSD lock feature so that settings or content cannot be changed.

- Press and hold the Settings key for at least 10 seconds and enter password to access the settings menu in OSD Lock.

## [IR Operation Lock]

- If you set this feature to [Off (Normal)], you can use your remote control.
- If you set this feature to [On (Power Key Only)], you can only use the power key.
- If you set this feature to [On (Block All)], you cannot use your remote control. (However, Power On feature is available.)
- Press and hold the Settings key for at least 10 seconds and enter password to access the settings menu in IR Operation Lock.

## [Local Key Lock]

This feature enables you to configure the Local Key Operation Lock feature so that settings or content cannot be changed.

- If you set this feature to [Off (Normal)], you can use the local keys on the monitor.
- If you set this feature to [On (Power Key Only)], you can only use the power key. (When you use a joystick, press and hold a local key to turn on/off the monitor.)
- If you set this feature to [On (Block All)], you cannot use the local keys. (However, Power On feature is available.)

## [Wi-Fi Lock]

This feature enables you to turn the Wi-Fi feature on or off.

## [Wired Connection Lock]

This feature enables you to turn the Wired network connection on or off.

## [Screen Share Lock]

This feature enables you to turn the Screen Share feature on or off.

If the Screen Share Lock value is changed, the function is not applied without a reboot.

## [Change Password]

You can change the admin password. (The default password: 000000)

- 1 Enter your current password.
- 2 Enter a new 6-digit password.
- 3 Enter the same password again in the Confirm Password field for confirmation.

## [Enterprise Settings]

- Enter your company account code to apply the corresponding enterprise settings.
- When your code has been entered, the monitor set gets reset, thereby applying the corresponding enterprise settings.
- This feature does not get activated if a code has already been entered.

## [HDCP Dynamic output control]

- Only HDCP protected content will be encrypted delivered when you set 'On'.
- Every content will be encrypted delivered when you set 'Off'.

## [Factory Reset]

Initializes all settings in [Setting] and files from the internal storage.

The exceptions are RGB gain value of [Calibration] mode, [Video Wall]([Tile Mode], [Tile Mode Setting], [Natural Mode], [Frame Control], [Scan Inversion]) and [Server Setting] items of [Ez Setting], and [Set ID] items of [General].

### **NOTE**

- It keeps the existing settings because the Off / On button in the User menu only affects the active / inactive status of the submenu.

# CONTENT MANAGER

## Web Login

- Different features are supported depending on the product.
- This Signage product comes with a feature that enables you to access it on your PC or mobile device.
- Content Manager, Group Manager 2.0, Control Manager, Log Out, Change Password menus are provided.
  - URL: <https://set ip:3777>
  - You can check the initial password in **HOME / ⬆** -> [Mobile URL] menu.

### CAUTION

- Supported resolutions (this program is optimized for the following resolutions):
  - PC: 1920 x 1080
  - Mobile: 360 x 640(1440 x 2560, 1080 x 1920), DPR
- Supported browsers (this program is optimized for the following browsers):
  - Chrome 85 or later (recommended)
- For security, please Login with the initial password and change the password.
- After the initial password has been changed, the password is not displayed in the **HOME / ⬆** -> [Mobile URL] menu.

## Content Manager

### [Player]

**HOME / ⬆** →  (Player)

The Content Manager app's player feature enables you to play/manage contents of video, image, template, SuperSign and playlist in an integrated way. (The OLED models do not support the playback and management of image content and template content.)

### [Continuous Play]

- 1 Select your desired type of content from the tab on the left and then select your desired content.
- 2 Click [Play] in the upper right-hand corner of the screen and enjoy the content you have selected.

### [Export]

- 1 Select your desired type of content from the tab on the left and click [Export] in the upper right-hand corner of the screen.
- 2 Select the content you wish to export.
- 3 Click [Copy]/[Move] in the upper right-hand corner of the screen and select the device to which you wish to export the content. (If a content file stored on the target device has been selected, the processing of the content file is skipped.)
- 4 You can see that the content has been moved/copied to the device.

**[Delete]**

- 1 Select your desired type of content from the tab on the left and click [Delete] in the upper right-hand corner of the screen.
- 2 Select the content you wish to delete.
- 3 Click [Delete] in the upper right-hand corner of the screen.
- 4 You can see that the content has been deleted.

**[Filter / Sort]**

- 1 Click [Filter / Sort] in the upper right-hand corner of the screen.
- 2 1) Choose your desired sort criterion to sort content files either by file name or in the order they have been played (the most recently played file shown at the top of the list).  
2) It is possible to only view the content stored on your desired device by filtering content files by device.  
3) It is possible to only view the content of your desired type by filtering content files by content type.

**[Create Playlist]**

When creating a playlist, \*, /, " ; , ? , < , > , | \ , , # cannot be used in the playlist file name. In addition, if the playlist contains content files whose names include such characters, you cannot move or copy the playlist.

- 1 Select the [Playlist] tap from the tab on the left and click [Create Playlist] in the upper right-hand of the screen.
- 2 Select the content you wish to add to the playlist and click [NEXT] in the upper right-hand of the screen.
- 3 Set a play time for each piece of content (applicable only for photo and template content), as well as other items such as Conversion Effect, Ratio, and Auto Playback, and then click [DONE] button in the upper right-hand corner of the screen.
- 4 You can see a new [Playlist] has been created.

**[Distribution]**

- 1 Click [Distribute] in the upper right-hand corner of the screen.
- 2 Go to the Group Manager app to distribute the created playlists.

**! NOTE**

- The Distribute button shows only when playlist is selected as media type.

## [Scheduler]

HOME /  →  (Scheduler)

The Content Manager app's scheduler feature enables certain content to be played at a scheduled time through a playlist or external input.

### [Creating a Schedule]

- 1 Click [New Schedule] in the upper right-hand corner of the screen.
- 2 Choose between [Playlist] and [Input Source].
- 3 1) If you have selected [Playlist], select the playlist you wish to schedule the playback of.  
2) If you have selected [Input Source], select the external input source you wish to schedule the playback of.
- 4 Enter schedule information and create a new schedule. (When creating a schedule, \*, /, ", ;, <, >, |, \, ,, # cannot be used in the schedule file name. In addition, if the playlist linked to the schedule contains content files whose names include such characters, you cannot move or copy the playlist.)
- 5 Watch the playlist or external input you selected play back at its scheduled time.

### [Importing a Schedule]

- 1 Click [Import] in the upper right-hand corner of the screen.
- 2 Select the external storage device from which you wish to import a schedule.
- 3 Select the schedule you wish to import to your monitor. (You can only choose a single schedule.)
- 4 Click [Select] in the upper right-hand corner of the screen.
- 5 Check that the schedule has been imported to the monitor's internal storage memory.

### [Exporting a Schedule]

- 1 Click [Export] in the upper right-hand corner of the screen.
- 2 Select the external storage device to which you wish to export a schedule.
- 3 Select the schedule you wish to export from your monitor. (You can choose multiple schedules.)
- 4 Click [Select] in the upper right-hand corner of the screen.
- 5 Check that the schedule has been exported to the external storage device you selected.

**[Delete Schedule]**

- 1 Click [DELETE] in the upper right-hand corner of the screen.
- 2 Select the schedules you wish to delete.
- 3 Click [DELETE].
- 4 Check that the schedules have been deleted.

**[Calendar View]**

- 1 When you have registered schedules, click [Calendar View].
- 2 You can see that the schedules registered are displayed in the form of a timetable.

**[Distribute]**

- 1 Click [Distribute] in the upper right-hand corner of the screen.
- 2 Go to the Group Manager app to distribute the created schedules.

**! NOTE**

- If the schedule creation time overlaps, the previously created schedule is deleted.
- Schedule does not work while Scheduling list app is running.

**[Editor]**

HOME /  →  (Editor)

The Content Manager app's editor feature enables you to add your desired templates.

- 1 Select the template of your desired format. (You can choose between Landscape mode and Portrait mode.)
- 2 Modify the template's text.
  - 2-1. Apply your desired font style (Size, Weight, Underline, Italic)
- 3 Modify the media file.
  - 3-1. Select and apply the rate you want.
- 4 Save the template by clicking [Save] in the top right-hand corner of the screen.
- 5 Check that the template you saved is shown in the template list.

## Supported Photo & Video Files

### ! NOTE

- Subtitles are not supported.
- The photo feature is not supported in OLED model.

### Supported video codecs

Extension	Codec	
.asf, .wmv	Video	VC-1 Advanced Profile (except for WMVA), VC-1 Simple and Main Profiles
	Audio	WMA Standard (excluding WMA v1/WMA Speech)
.avi	Video	Xvid (excluding 3 warp-point GMC), H.264/AVC, Motion Jpeg, MPEG-4
	Audio	MPEG-1 Layer I, II, MPEG-1 Layer III (MP3), Dolby Digital, LPCM, ADPCM, DTS
.mp4, .m4v, .mov	Video	H.264/AVC, MPEG-4, HEVC
	Audio	Dolby Digital, Dolby Digital Plus, AAC, MPEG-1 Layer III (MP3)
.3gp	Video	H.264/AVC, MPEG-4
.3g2	Audio	AAC, AMR-NB, AMR-WB
.mkv	Video	MPEG-2, MPEG-4, H.264/AVC, VP8, VP9, HEVC
	Audio	Dolby Digital, Dolby Digital Plus, AAC, PCM, DTS, MPEG-1 Layer I, II, MPEG-1 Layer III (MP3)
.ts, .trp, .tp, .mts	Video	H.264/AVC, MPEG-2, HEVC
	Audio	MPEG-1 Layer I, II, MPEG-1 Layer III (MP3), Dolby Digital, Dolby Digital Plus, AAC, PCM
.mpg, .mpeg, .dat	Video	MPEG-1, MPEG-2
	Audio	MPEG-1 Layer I, II, MPEG-1 Layer III (MP3)
.vob	Video	MPEG-1, MPEG-2
	Audio	Dolby Digital, MPEG-1 Layer I, II, DVD-LPCM

### Maximum transmit ratio

Full HD movie	H.264 1920 x 1080@60P BP/MP/HP@L4.2 40Mbps HEVC 1920 x 1080@60P Main/Main10@L4.1 40Mbps
ULTRA HD movie (UHD models only.)	H.264 3840 x 2160@30P BP/MP/HP@L5.1 50Mbps HEVC 3840 x 2160@60P Main/Main10@L5.1 60Mbps

### Supported Photo File Formats

File type	Format	Resolution
.jpeg, .jpg, .jpe	JPEG	<ul style="list-style-type: none"> <li>• Minimum: Min: 64 x 64</li> <li>• Maximum: Normal Type: 15360 (W) x 8640 (H) Progressive Type: 1920 (W) x 1440 (H)</li> </ul>
.png	PNG	<ul style="list-style-type: none"> <li>• Minimum: Min: 64 x 64</li> <li>• Maximum: 5760 (W) x 5760 (H)</li> </ul>
.bmp	BMP	<ul style="list-style-type: none"> <li>• Minimum: Min: 64 x 64</li> <li>• Maximum: 1920 (W) x 1080 (H)</li> </ul>

### Tips for using USB storage devices

- Only USB storage devices are recognized.
- USB storage devices connected to the monitor through a USB hub may not work properly.
- USB storage devices that use an automatic recognition program may not be recognized.
- USB storage devices that use their own drivers may not be recognized.
- The recognition speed of a USB storage device may depend on each device.
- Please do not turn off the display or unplug the USB device when the connected USB storage device is working. When the device is suddenly separated or unplugged, the stored files or the USB storage device may be damaged.
- Please do not connect the USB storage device which was artificially maneuvered on the PC. The device may cause the product to malfunction or fail to be played. Remember to only use USB storage devices that store normal music, image, and/or movie files.
- Storage devices formatted with utility programs that are not supported by Windows may not be recognized.
- Please connect power to a USB storage device (over 0.5 A) which requires an external power supply. Otherwise, the device may not be recognized.
- Please connect a USB storage device with the cable offered by the device maker.
- Some USB storage devices may not be supported or operated smoothly.
- File alignment methods of the USB storage device is similar to Windows XP and filenames can include up to 100 English characters.
- Be sure to back up important files since data stored in a USB memory device may be damaged. We will not be responsible for any data loss.
- If the USB HDD does not have an external power source, the USB device may not be detected. So make sure to connect it to an external power source.
  - Please use a power adapter for an external power source. No USB cable is provided for an external power source.
- Please use only USB storage devices formatted with the FAT32 or NTFS file system provided by Windows.

- If your USB storage device has multiple partitions, or if you use a USB multi-card reader, you can use up to four partitions or USB memory devices.
- If a USB storage device is connected to a USB multi-card reader, its volume data may not be detected.
- If the USB storage device does not work properly, remove it and connect it again.
- If the USB storage device is connected in Standby Mode, a specific hard disk will automatically be loaded when the display is turned on.
- The recommended capacity is 1 TB or less for a USB external hard disk and 32 GB or less for USB memory.
- Any device with more than the recommended capacity may not work properly.
- If a USB external hard disk with an energy saving feature does not work, turn the hard disk off and on again to make it work properly.
- USB storage devices (USB 2.0 or below) are also supported. However, they may not work properly in the videos list.
- A maximum of 999 folders or files can be recognized under one folder.
- When distributing contents to USB while playing a video in UHD resolution, the video might experience temporary stuttering.
- USB storage devices supported by a mobile device may not be recognized.
- Even if multiple USB storage devices are connected, only one USB storage device can be used.

## Group Manager 2.0

This feature enables you to group together multiple monitor sets on a single network into the same group and to distribute content (schedules and playlists) or copy setting data on a group basis. This feature has two modes, Master and Slave, and it can access the browser on your PC or mobile device.

### [Master]

- Add, edit, and delete group.
- Clone your device's settings data.
- Distribute [Schedule] and [Playlists] on a group basis.
- All monitor sets initially come in Master mode.

### [Slave]

- Play [Schedule] and [Playlists] distributed in Master mode.
- Remove monitor sets for their groups.
- Monitor sets that have been added to a group are automatically switched to Slave mode. Conversely, when a monitor set has been deleted from a group, it is automatically initialized and switched to Master mode.
- If a new Slave has been added to an existing group, or if the [Data Cloning] or the distribution of [schedule]/[Playlist] has not been properly performed, the [Data Cloning] or [Sync] button will be activated.
- You can duplicate the master device's setting data to the group by using [Data Cloning].
- You can re-download the content distributed to the group by using [Sync].

## **GROUP MANAGEMENT**

- **Creating a New Group**
  1. Click [Add New Group].
  2. Enter a group name.
  3. Click [Add Device], select the devices you wish to add to the group, and add them.
  4. Click [Done], and you will see that a new group has been created.
- **Editing a Group**
  1. Click the group you wish to edit.
  2. Add a new device by using [Add Device].
  3. Delete a device by using [Delete Device].
  4. Check whether the devices in the group are connected to a network by using [Device Check].
  5. If there are any sets of devices in the group that are not [Data Cloning] or content synchronized, [Data Cloning] or [Sync] button will be activated.
  6. You can re-copy the master device's setting data to the group by using [Data Cloning].
  7. You can re-distribute the content distributed to the group by using [Sync].
- **Deleting a Group**
  1. Click [Delete Group].
  2. Select the group you wish to delete and click [Delete].
  3. Check that the group you selected has been deleted.
- **All Devices View:** This page enables you to manage all slave monitor sets that are connected to the same network.
  1. Click [All Devices View].
  2. Click [Reset Device Mode].
  3. Select the slave monitor set whose device mode you wish to change and click [Reset].

**[Setting Data Cloning]**

- 1 Select your desired group and click Clone.
- 2 Check that the data have been copied on the slave sets.

**[Content Distribute]**

- 1 Select the type of content you wish to distribute (Schedules or Playlists).
- 2 Select the content you wish to distribute.
- 3 Select the group to which you wish to distribute the content and click [Distribute].
- 4 Run the Content Manager app on the slave sets and check that the content has been distributed.

**How to Use**

- Monitor: Run, add, delete or edit app on the home screen.
- Mobile: Mobile devices: Run the app in the Launcher bar or access the app from a mobile device using the QR code or URL provided.

**CAUTION**

- You can create up to 25 groups.
- You can add up to 12 slave devices to a group.
- You can distribute the schedules stored on external devices after executing Content Manager's import operation.
- Make sure to delete all schedules stored on the slave sets before distributing any schedules.
- A list of devices you can add to your desired group appears only when the following conditions have been met:
  - The devices you wish to add must be on the same network as the master device.
  - The devices you wish to add must be in Master mode, and they must not belong to any existing group.
  - The UPnP feature must be enabled (go to [General] > [Network] > UPnP and set it to [On]).
- It may not work properly in wireless network environments. It is recommended you use a wired network.
- Run the initial settings for Slave function when deleting the group.

## ScreenShare

This feature allows the screen of a user's device such as a mobile or PC Windows to be shared with a display using a wireless connection such as WiDi or Miracast.

### How to Use [ScreenShare]

INPUT /  →  → [ScreenShare]

- 1 Connect according to the instructions provided by the guide that can be accessed through the CONNECTION GUIDE button in the upper right.
- 2 Once the connection is established, Screen Share between the user device and the monitor is enabled.

### **NOTE**

- For the information on how to use Intel WiDi, visit PC/laptop manufacturer webpage.
- This feature only works properly with WiDi 3.5 or later versions.
- This feature only works on Windows 8.1 or later.

## LG Presenter

This feature is to display the PC (Windows or Mac OS) screen on the Signage monitor with wired/wireless connection to the PC. To use this feature, you need to install LG Presenter PC Client ("Client") on the PC.

You can use LG Presenter in the following ways.

- Connect: Enter the PIN code to connect your Signage device to the Client.
- Screen Share: Share the PC screen of the connected Client with your Signage device.
- Hand over: If a Client is already connected and another Client needs to share screen, you can request for a hand over to the connected Client to get permission to share screen.
- Settings: You can see the information of the Client or change the language used by the Client.

### NOTE

- This feature may not be available on some models.
- Only sharing PC screen is supported and not voice sharing.

## Connect

### On Signage

INPUT /  → [LG Presenter]

### On PC

- 1 Go to [www.lge.com/LGP](http://www.lge.com/LGP) to download the Client.
- 2 Install and run the downloaded Client.
- 3 Enter the username you want and press the button .
- 4 Select either auto search or manual search to connect your device.
  - Auto search
    - When the list of Signage devices found in the network appears, select the one you want to connect to.
  - Manual search
    - Click "New", type the name of the device you want to connect and the IP address shown on Signage and click [Connect].
- 5 Enter the PIN code you see on your Signage device into the PIN code field on the Client.

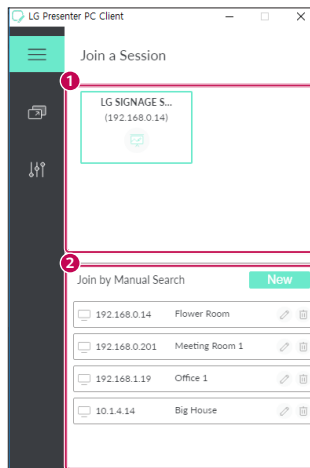

No.	Item	Description
1	Auto search	Automatically search Signage in the same network.
2	Manual search	Type the IP address and name manually, or select the device you want to connect in the connection list.

### CAUTION

- Signage and the PC need to be in the network that they can be connected to each other.
- If a certain port (UDP 1900) of Signage is blocked, Client program cannot automatically search Signage.
- Client program might not be able to connect to or share the screen with Signage via manual search, depending on the network configuration.

## Screen Share

- 1 Select the screen you want to share and press the “Share” button.
- 2 To leave Screen Share, press the [STOP] button.



### CAUTION

- if Screen Share does not work or won't connect to the Signage device, check the firewall settings on your PC.

## Handover

PC1: The PC where the client currently connected to your Signage device is running.

PC2: The PC you want to connect to the Signage device connected to PC1.

### On PC2

- 1 Run Client program to connect Signage that PC1 is connected to.

### On PC1

- 1 When the hand over request pop-up appears on PC2, select whether to approve or deny the request.
- 2 If you approve the request for hand over, the Signage device will be disconnected, and the Client on PC2 will be connected to the Signage device.
- 3 If you deny the request for hand over, the Signage device will remain connected, so you can continue to use the features of LG Presenter.

# MANAGEMENT TOOLS

## Control Manager

Control and check the status of the display through the Web browser.

This function is available for PCs and mobile devices.

Different features are supported depending on the product.

### Function

- [Dashboard]: Display a summary of the product's status and provides links to each page.
- [Display & sound]: Provides features such as Screen Brightness, Sound, Input, and Reboot.
- [Time & Date]: Enable/disable Set Automatically feature and displays/changes the time set for the product.
- [Network]: Set the name and IP address of your Signage monitor.
- [Tile Mode]: Display the tile mode settings of the product.
- [Fail Over]: Turns the Fail Over feature on or off and sets related items.
- [Play via URL]: Turn Play via URL on or off and set URLs.
- [S/W Update]: Update the firmware of the product.
- [Charts]: Output the product's status information such as its temperature and fan status.
- [Log]: Output product malfunction records.
- [System Information]: Output information such as the product's software version and model name.

## Picture ID

[Picture ID] is used to change the settings of a specific set (display) using a single IR receiver for multi-vision. Communication is possible between a monitor with an IR receiver and other monitors using RS-232C cables. Each monitor is identified by a Set ID. Setting [Picture ID] allows you to only use the remote control with monitors with a [Set ID] that matches the [Picture ID].

- 1 Assign [Set ID] to the installed monitors as shown below:

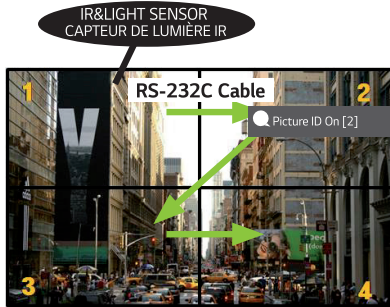

- 2 Press the red [Picture ID] [On] button on the remote control.
  - 3 Make sure that the Picture ID you set is identical to the [Set ID] of the monitor you wish to control.
- A set with a [Set ID] that is different from the [Picture ID] cannot be controlled by IR signals.

### ! NOTE

- If [Picture ID] has been set to 2, only the upper right monitor, which has a [Set ID] of 2, can be controlled by IR signals.
- If you press the green [Picture ID] [Off] button on your remote control, the [Picture ID] for all monitors are turned off. If you then press any button on the remote control, all monitors can be controlled by IR signals regardless of their [Set ID]'s.

# TOUCH









## Touch Assistive Menu

This touch-exclusive feature allows the user to configure settings without a remote control.

Touching the screen for a certain period of time or pressing the Touch Assistive Menu local key brings up the Touch Assistive Menu on the screen.

Different features are supported depending on the product.

### Function

-  : Navigates to the Home screen.
-  : Navigate to the external input selection screen.
-  : Navigates to the Settings screen.
-  : Go to SI App Selection screen
  -  : Run SI Apps installed with ZIP Type
  -  : Run SI Apps installed with IPK Type
  -  : Go to Developer Mode
  -  : Go to SI Server Setting
-  : Go to the volume control screen

# TO CONTROL AN EXTERNAL PC USING TOUCH SCREEN

- This only applies to certain models.

## Connecting to a PC

Connecting this product to a PC with a USB cable (Type A to Type B) allows you to control the connected PC by touching the screen of the product.

For a PC that supports USB-C, use a USB-C cable to connect this product to the PC and control the PC using the touch screen.

You can control the installed OPS by touching the screen of the product even with the OPS installed.

## Prioritized Tasks on the Touch Screen

Priority	States	Operation Conditions	Device performing the task when the screen is touched
1	<ul style="list-style-type: none"> <li>• External input rotation set to 90°/180°/270°</li> <li>• Menu, App, dashboard, etc. displayed</li> <li>• Pop-up message displayed</li> </ul>	Only one of the states is shown	Screen of the product
2	<ul style="list-style-type: none"> <li>• Equipped with OPS</li> <li>• External input configured for OPS</li> </ul>	All states are shown	OPS
3	<ul style="list-style-type: none"> <li>• Connected to a PC with a USB-C cable</li> <li>• External input configured for USB-C</li> </ul>	All states are shown	PC connected with USB-C
4	<ul style="list-style-type: none"> <li>• External input configured (except for OPS/USB-C)</li> <li>• PC connected to the front of the product with a touch cable</li> </ul>	All states are shown	PC connected to the front of the product with a touch cable
5	<ul style="list-style-type: none"> <li>• External input configured (except for OPS/USB-C)</li> <li>• PC connected to the rear of the product with a touch cable</li> </ul>	All states are shown	PC connected to the rear of the product with a touch cable

### NOTE

- When connecting to an external PC and using it with a touch screen, it may take a while to recognize your touch on the touch screen device upon switching the connection for the touch function between external PCs.

# SMART CALIBRATION

## How to Run

W.BAL → [Smart Calibration]

- 1 Set the Set ID of each set.
- 2 Select the [Picture Mode] to execute Smart Calibration.

When you set [Picture mode] to [Calibration] mode, you can set [Color Temperature] among [3000 K / Optimal Target / Original].

- [Optimal Target]: Set the optimal color value of the installed set as the target.
- Please set the target to 3,000K in the broadcasting station environment.

When you set [Picture mode] except [Calibration] mode, you can set [Color Temperature] within 3200K~13000K. You can adjust it in units of 100K.

- 3 With [START SMART CALIBRATION], you can correct the color/brightness.
- 4 If you set the [Schedule Setting] menu, calibration is performed automatically on a regular basis.

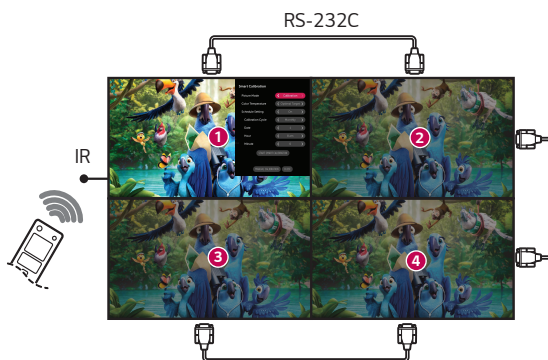
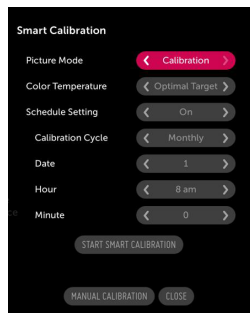

## [Manual Calibration]

You can manually adjust the color of the selected location.

- [Screen Split]: Set the manual adjustment area.
- [Calibration Position]: Select the manual adjustment location.

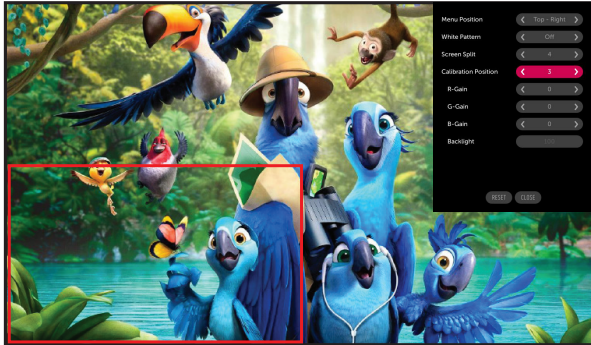



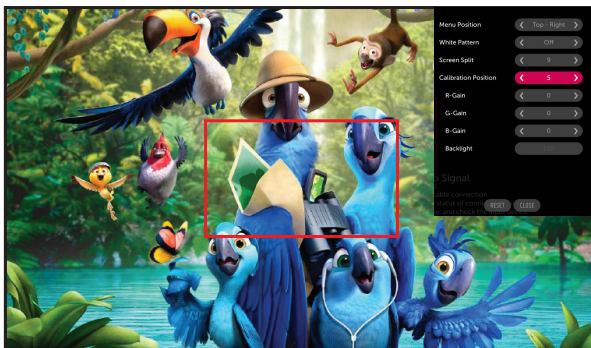





Screen Split: 4, Calibration Position: 3





Screen Split: 9, Calibration Position: 5

# IR CODE

- All models do not support the HDMI/USB function.
- Some key codes may not be supported depending on the model.

Code (Hex)	Function	Remarks
08	 (Power)	Remote control button
C4	MONITOR ON	Remote control button
C5	MONITOR OFF	Remote control button
95	<b>ENERGY SAVING</b>	Remote control button
0B	INPUT (Select input)	Remote control button
10	Number Key 0	Remote control button
11	Number Key 1	Remote control button
12	Number Key 2	Remote control button
13	Number Key 3	Remote control button
14	Number Key 4	Remote control button
15	Number Key 5	Remote control button
16	Number Key 6	Remote control button
17	Number Key 7	Remote control button
18	Number Key 8	Remote control button
19	Number Key 9	Remote control button
02	 (Vol +)	Remote control button
03	 (Vol -)	Remote control button
E0	Brightness  (Page Up)	Remote control button
E1	Brightness  (Page Down)	Remote control button
DC	 (3D)	Remote control button
32	1/a/A	Remote control button
2F	CLEAR	Remote control button
7E	 SIMPLINK	Remote control button
79	ARC (Mark/Aspect Ratio)	Remote control button
4D	PSM (Picture Mode)	Remote control button
09	 (MUTE)	Remote control button
43	 (Settings/Menu)	Remote control button
99	Auto Configuration	Remote control button
40	 (Up)	Remote control button
41	 (Down)	Remote control button
06	 (Right)	Remote control button
07	 (Left)	Remote control button
44	 (OK)	Remote control button
28	 (BACK)	Remote control button

Code (Hex)	Function	Remarks
7B	Tile	Remote control button
5B	Exit	Remote control button
72	Picture ID On (red)	Remote control button
71	Picture ID Off (green)	Remote control button
63	Yellow	Remote control button
61	Blue	Remote control button
5F	W.Bal	Remote control button
3F	 (S.Menu)	Remote control button
7C	 (Home)	Remote control button
97	Swap	Remote control button
96	Mirror	Remote control button

# CONTROLLING MULTIPLE PRODUCTS

- This only applies to certain models.

Use this method to connect several products to a single PC. You can control several products at a time by connecting them to a single PC.

In the Option menu, the Set ID must be between 1 and 1000 without being duplicated.

## Connecting cables

- Images may differ according to the model.

Connect the RS-232C cable as shown in the picture.

The RS-232C protocol is used for communication between the PC and product. You can turn the product on/off, select an input source and adjust the OSD menu from your PC.

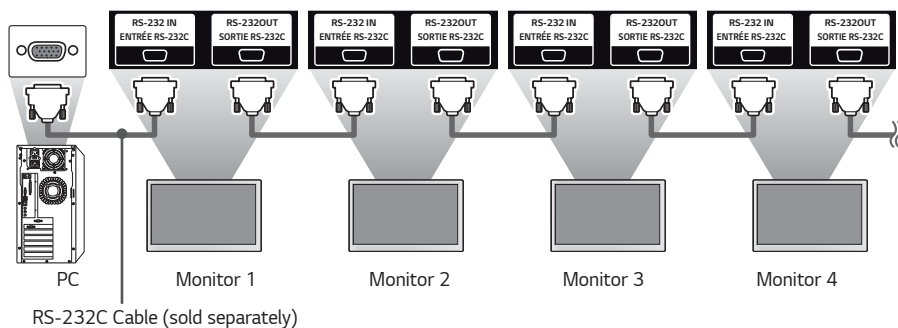
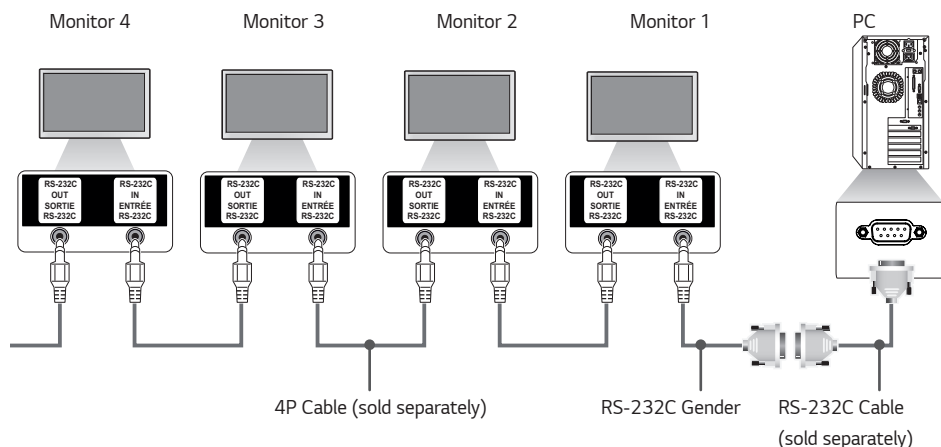

## Communication Parameter

Baud Rate: 9600 BPS  
 Data Length: 8 bits  
 Parity Bit: None  
 Stop Bit: 1 bit  
 Flow Control: None  
 Communication Code: ASCII

### ! NOTE

- When using 3-wire connections (non-standard), an IR daisy chain cannot be used.
- Be sure to only use the provided gender to connect properly.
- When you have daisy-chained multiple Signage products to control them simultaneously, if you attempt to turn on/off the master device in a continuous manner, some products may not turn on. In this case, you can turn those monitors on by pressing the **MONITOR ON** button, not the Power button.

⏻ (Power)

**MONITOR ON**

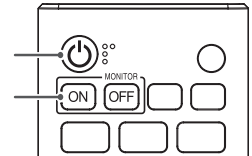

## Command Reference List

		Command		Data (Hexadecimal)
		1	2	
01	[Power]	k	a	00 to 02
02	Select Input	x	b	See Select Input
03	[Aspect Ratio]	k	c	See [Aspect Ratio]
04	[Brightness Control]	j	q	00 to 04
05	[Picture Mode]	d	x	See [Picture Mode]
06	[Contrast]	k	g	00 to 64
07	[Brightness]	k	h	00 to 64
08	[Sharpness]	k	k	00 to 32
09	[Color]	k	i	00 to 64
10	[Tint]	k	j	00 to 64
11	[Color Temperature]	x	u	70 to D2
12	[Balance]	k	t	00 to 64
13	[Sound Mode]	d	y	See [Sound Mode]
14	[Mute on]	k	e	00 to 01
15	Volume Control	k	f	00 to 64
16	[Current Time] 1 (year/month/day)	f	a	See [Current Time] 1
17	[Current Time] 2 (hour/minute/second)	f	x	See [Current Time] 2
18	[No Signal Power Off (15 Min)]	f	g	00 to 01
19	[No IR Power Off (4hour)]	m	n	00 to 01
20	[Language]	f	i	See [Language]
21	Default Settings	f	k	00 - 02
22	Current Temperature	d	n	FF
23	[Key]	m	c	See [Key]
24	Time Elapsed	d	l	FF
25	Check product serial number	f	y	FF
26	[Software Version]	f	z	FF
27	[White Balance] Red Gain	j	m	00 to FE
28	[White Balance] Green Gain	j	n	00 to FE
29	[White Balance] Blue Gain	j	o	00 to FE
30	[White Balance] Red Offset	s	x	00 to 7F
31	[White Balance] Green Offset	s	y	00 to 7F
32	[White Balance] Blue Offset	s	z	00 to 7F
33	[Backlight]	m	g	00 to 64
34	[Screen Off]	k	d	00 to 01
35	[Tile Mode]	d	d	00 to FF
36	Check [Tile Mode]	d	z	FF
37	[Tile ID]	d	i	See [Tile ID]
38	[Natural Mode]	d	j	00 to 01

		Command		Data (Hexadecimal)
		1	2	
39	[DPM] / [DPM (Standby Mode)]	f	j	See [DPM] / [DPM (Standby Mode)]
40	Remote Control/Local Key Lock	k	m	00 to 01
41	[Power On Delay]	f	h	00 to FA
42	Select [Fail Over] Mode	m	i	00 to 02
43	Select [Fail Over] Input	m	j	See Select [Fail Over] Input
44	Remote Control Key Lock	t	p	00 to 02
45	Local Key Lock	t	o	00 to 02
46	[Status Check]	s	v	See [Status Check]
47	[Daylight Saving Time]	s	d	See [Daylight Saving Time]
48	[PM Mode]	s	n, 0c	00 to 05
49	[ISM Method]	j	p	See [ISM Method]
50	[Network Setting]	s	n, 80(81) (82)	See [Network Setting]
51	[Power On Status]	t	r	00 to 02
52	Wired [Wake On LAN] / [Wake On LAN (Networked Standby Mode)]	f	w	00 to 01
53	[Screen Rotation]	t	h	00 to 03
54	[Time Sync]	s	n, 16	00 to 01
55	[Contents Sync]	t	g	00 to 01
56	[LAN Daisy Chain]	s	n, 84	00 to 01
57	[External Input Rotation]	s	n, 85	00 to 03
58	[Beacon]	s	n, 88	00 to 01
59	[Brightness Scheduling] Mode	s	m	00 to 01
60	[Brightness Scheduling]	s	s	See [Brightness Scheduling]
61	[Multi Screen] Mode & Input	x	c	See [Multi-screen] Mode & Input
62	[Aspect Ratio] (Multi screen)	x	d	See [Aspect Ratio] (Multi screen)
63	[Screen Off] (Multi screen)	x	e	See [SCREEN OFF] (Multi screen)
64	[Screen Off Always]	s	n, 0d	00 to 01
65	Stop Video	k	x	00 to 01
66	Wireless [Wake On LAN] / [Wake On LAN (Networked Standby Mode)]	s	n, 90	00 to 01
67	[OSD Lock]	k	l	00 to 01
68	[HDMI IT Content]	s	n, 99	00 to 01
69	[Holiday Setting]	s	n, 9b	See [Holiday Setting]
70	[UPnP]	s	n, 9c	00 to 01
71	[Home Dashboard Lock]	s	n, 9d	00 to 01
72	[USB Lock]	s	n, 9e	00 to 01
73	[Wi-Fi Lock]	s	n, 9f	00 to 01

		Command		Data (Hexadecimal)
		1	2	
74	[Screen Share Lock]	s	n, a0	00 to 01
75	[Backup via Storage]	s	n, a1	See [Backup via Storage]
76	[Digital Audio Input]	s	n, a2	00 to 01
77	[Bootimg Logo Image]	s	n, a3	00 to 01
78	[SoftAP]	s	n, a4	00 to 01
79	[Natural Size]	s	n, a5	00 to 64
80	Play Saved Internal Media	s	n, a8	See Playback of Saved Internal Media
81	[No Signal Image]	s	n, a9	00 to 01
82	[Audio Out]	s	n, aa	00 to 02
83	[DPM Wake Up Control] / [DPM (Standby Mode) Wake Up Control]	s	n, 0b	00 to 01
84	Check [Fan] Failure	d	w	FF
85	[Apply to all inputs]	s	n, 52	01
86	[Timer Power On]	f	d	See [Timer Power On]
87	[Timer Power Off]	f	e	See [Timer Power Off]
88	LCIN008 Control	s	n,b8	See LCIN008 Control
89	[Transfer Control]	s	n,cb	See Transfer Control
90	Multichannel	s	n,76	01 to 09
91	Change Setid	j	x	See Change Setid
92	[Gamma]	s	n,ad	00 to 03
93	[Black Level]	s	n,ae	00 to 02
94	[UHD Deep Color]	s	n,af	See [UHD Deep Color]
95	[Sync Mode]	s	n,b0	00 to 01

		Command		Data (Hexadecimal)
		1	2	
96	[Input Manager]	s	n,b1	See [Input Manager]
97	[PC/OPS Power Control]	s	n,8b	00 to 02
98	[LED Local Dimming]	s	n,c1	00 to 01
99	[Scan Inversion]	s	n,87	00 to 01
100	[Frame Control]	s	n,b7	00 to 01
101	[Average Picture Level Auto Control]	s	n,be	00 to 01
102	Read Brightness Value	m	u	FF
103	[Screen Fault Detection]	t	z	00 to 01
104	[Stereo Mode]	s	n,c2	00 to 02
105	[HDR Picture Mode]	s	n,c4	See [HDR Picture Mode]
106	[Dynamic Tone Mapping]	s	n,c5	00 to 01
107	[LED Local Dimming]	s	n,c6	00 to 03
108	[USB2 to HDBaseT]	s	n,c3	00 to 01
109	[Change Password]	s	n,a7	See [Change Password]
110	[Brightness Range Adjustment]	s	n,ab	See [Brightness Range Adjustment]
111	[Color Calibration]	s	n,d6	00 to 01
112	[Quiet Mode]	s	n,c7	00 to 01

\* Note Commands may not work when there is no external input used.

\* Some commands may not be supported on some models.

# Transmission/Reception Protocol

## Transmission

(Command1)(Command2)( )(Set ID)( )(Data)(Cr)

- \* (Command1): This command is used to identify between the adjustment setting or the user adjustment modes.
- \* (Command2): This command is used to control the monitor.
- \* (Set ID): Used for selecting a set you want to control. A unique Set ID can be assigned to each set ranging from 1 to 1000 (01H to 3E8H) under Settings in the OSD menu. Selecting '00H' for Set ID allows the simultaneous control of all connected monitors. (The maximum value may differ depending on the model.)
- \* (Data): Transmits command data. Data count may increase depending on the command.
- \* (Cr): Carriage Return. This parameter corresponds to '0 x 0D' in ASCII code.
- \* ( ): White Space. This parameter corresponds to '0 x 20' in ASCII code.

## Acknowledgment

(Command2)( )(Set ID)( )(OK/NG)(Data)(x)

- \* The product transmits an ACK (acknowledgment) based on this format when receiving normal data. At this point, if the data is FF, it indicates the present status data. If the data is in data write mode, it returns the data of the PC computer.
- \* If a command is sent with Set ID '00' (=0 x 00), the data is reflected to all monitors and they do not send an acknowledgment (ACK).
- \* If you send "FF" as the value of the data in control mode via RS-232C, you can check the value currently set for the relevant feature (not applicable to some features).
- \* Some commands may not be supported on some models.

**01. [Power] (Command: k a)**

Controls the power on/off status of the monitor.

**Transmission**

(k)(a)( ) (Set ID)( ) (Data)(Cr)

Data 00: [Off]  
01: [On]  
02: Restart

**Acknowledgment**

(a)( ) (Set ID)( ) (OK/NG)(Data)(x)

- \* The Acknowledgment signal is returned properly only when the monitor is fully powered on.
- \* There may be a delay between the Transmission and Acknowledgment signals.
- \* This feature may not be available for all models.

**02. Select Input (Command: x b)**

Selects an input signal.

**Transmission**

(x)(b)( ) (Set ID)( ) (Data)(Cr)

Data 20: AV  
40: COMPONENT  
60: RGB  
70: DVI-D (PC)  
80: DVI-D (DTV)  
90: HDMI1 (DTV)  
A0: HDMI1 (PC)  
91: HDMI2 (DTV)  
A1: HDMI2 (PC)  
92: OPS/HDMI3/DVI-D (DTV)  
A2: OPS/HDMI3/DVI-D (PC)  
95: OPS/DVI-D (DTV)  
A5: OPS/DVI-D (PC)  
96: HDMI3/DVI-D (DTV)  
A6: HDMI3/DVI-D (PC)  
97: HDMI3/HDMI2/DVI-D (DTV)  
A7: HDMI3/HDMI2/DVI-D (PC)  
98: OPS (DTV)  
A8: OPS (PC)  
99: HDMI2/OPS (DTV)  
A9: HDMI2/OPS (PC)  
C0: DISPLAYPORT (DTV)  
D0: DISPLAYPORT (PC)  
C1: DISPLAYPORT/USB-C (DTV)  
D1: DISPLAYPORT/USB-C (PC)  
C2: HDMI3 (DTV)  
D2: HDMI3 (PC)  
C3: HDBaseT (DTV)  
D3: HDBaseT (PC)  
E0: SuperSign webOS Player  
E1: Others  
E2: Multi Screen  
E3: Play via URL

**Acknowledgment**

(b)( ) (Set ID)( ) (OK/NG)(Data)(x)

- \* Some input signals may not be available for all models.
- \* If it is not distributed from SuperSign W, WebOS Player returns NG.
- \* If it says "Read" from the IDB mode, it will respond as a PC Label type.

**03. [Aspect Ratio] (Command: k c)**

Adjusts the aspect ratio of your monitor.

**Transmission**

(k)(c)( ) (Set ID)( ) (Data)(Cr)

Data 02: [Full Screen]  
06: [Original]

**Acknowledgment**

(c)( ) (Set ID)( ) (OK/NG)(Data)(x)

- \* The aspect ratio may differ depending on the model's input configuration.

**04. [Brightness] (Command: j q)**

Sets the brightness of your monitor.

**Transmission**

(j)(q)( ) (Set ID)( ) (Data)(Cr)

Data 00: [Off]  
01: [Minimum]  
02: [Medium]  
03: [Maximum]  
04: [Auto]

**Acknowledgment**

(q)( ) (Set ID)( ) (OK/NG)(Data)(x)

- \* This feature may not be available for all models.

**05. [Picture Mode] (Command: d x)**

Selects a picture mode.

**Transmission**

(d)(x)( ) (Set ID)( ) (Data)(Cr)

Data 00: [Mall/QSR]  
01: [General]  
02: [Gov./Corp.]  
03: [Transportation]  
04: [Education]  
05: [Expert 1]  
08: [Auto Power Save]  
11: [Calibration]  
12: [Hospital]

**Acknowledgment**

(x)( ) (Set ID)( ) (OK/NG)(Data)(x)

- \* Some picture modes may not be available for all models.

**06. [Contrast] (Command: k g)**

Adjusts the screen contrast.

**Transmission****(k)(g)( )(Set ID)( )(Data)(Cr)**

Data 00-64: Contrast 0-100

**Acknowledgment****(g)( )(Set ID)( )(OK/NG)(Data)(x)****07. [Brightness] (Command: k h)**

Adjusts the screen brightness.

**Transmission****(k)(h)( )(Set ID)( )(Data)(Cr)**

Data 00-64: Brightness 0-100

**Acknowledgment****(h)( )(Set ID)( )(OK/NG)(Data)(x)****08. [Sharpness] (Command: k k)**

Adjusts the screen sharpness.

**Transmission****(k)(k)( )(Set ID)( )(Data)(Cr)**

Data 00-32: Sharpness 0-50

**Acknowledgment****(k)( )(Set ID)( )(OK/NG)(Data)(x)****09. [Color] (Command: k i)**

Adjusts the screen colors.

**Transmission****(k)(i)( )(Set ID)( )(Data)(Cr)**

Data 00-64: Color 0-100

**Acknowledgment****(i)( )(Set ID)( )(OK/NG)(Data)(x)****10. [Tint] (Command: k j)**

Adjusts the screen tints.

**Transmission****(k)(j)( )(Set ID)( )(Data)(Cr)**

Data 00-64: Tint Red 50-Green 50

**Acknowledgment****(j)( )(Set ID)( )(OK/NG)(Data)(x)****11. [Color Temperature] (Command: x u)**

Adjusts the screen color temperature.

**Transmission****(x)(u)( )(Set ID)( )(Data)(Cr)**

Data 70-D2: 3200K-13000K

**Acknowledgment****(u)( )(Set ID)( )(OK/NG)(Data)(x)****12. [Balance] (Command: k t)**

Adjusts the sound balance.

**Transmission****(k)(t)( )(Set ID)( )(Data)(Cr)**

Data 00-64: Left 50-Right 50

**Acknowledgment****(t)( )(Set ID)( )(OK/NG)(Data)(x)**

\* This feature may not be available for all models.

**13. [Sound Mode] (Command: d y)**

Selects a sound mode.

**Transmission**

(d)(y)( )(Set ID)( )(Data)(Cr)

Data 01: [Standard]  
02: [Music]  
03: [Cinema]  
04: [Sports]  
05: [Game]  
07: [News (Clear Voice III)]

**Acknowledgment**

(y)( )(Set ID)( )(OK/NG)(Data)(x)

\* This feature may not be available for all models.

**14. [Mute on] (Command: k e)**

Mutes/unmutes audio.

**Transmission**

(k)(e)( )(Set ID)( )(Data)(Cr)

Data 00: [Mute] (Volume off)  
01: Mute off (Volume on)

**Acknowledgment**

(e)( )(Set ID)( )(OK/NG)(Data)(x)

\* This feature may not be available for all models.

**15. Volume Control (Command: k f)**

Adjusts the playback volume.

**Transmission**

(k)(f)( )(Set ID)( )(Data)(Cr)

Data 00-64: Volume 0-100

**Acknowledgment**

(f)( )(Set ID)( )(OK/NG)(Data)(x)

\* This feature may not be available for all models.

**16. [Current Time] 1 (year/month/day) (Command: f a)**

Sets the Clock 1 (year/month/day) values and Auto Time.

**Transmission**

1. (f)(a)( )(Set ID)( )(Data1)( )(Data2)( )(Data3)(Cr)

2. (f)(a)( )(Set ID)( )(0)(0)( )(Data1)(Cr)

1. When setting Clock 1 (year/month/day)

Data1 00-: 2010 -

Data2 01-0C: January - December

Data3 01-1F: 1-31

\* The minimum and maximum values for Data1 differ depending on the product's release year.

\* Enter "fa [Set ID] ff" to view Clock 1 (year/month/day) settings.

2. When Setting Auto Time

Data1 00: [Auto]

01: [Manual]

\* To view the set value of the Auto time, enter "fa [Set ID] 00 ff".

**Acknowledgment**

1. (a)( )(Set ID)( )(OK/NG)(Data1)(Data2)(Data3)(x)

2. (a)( )(Set ID)( )(OK/NG)(0)(0)(Data1)(x)

**17. [Current Time] 2 (hour/minute/second) (Command: f x)**

Sets the Clock 2 values (hour/minute/second).

**Transmission**

(f)(x)( )(Set ID)( )(Data1)( )(Data2)( )(Data3)(Cr)

Data1 00-17: 00-23 hours

Data2 00-3B: 00 - 59 minutes

Data3 00-3B: 00-59 seconds

\* Enter "fx [Set ID] ff" to view the Time 2 (hour/minute/second) settings.

\* This feature is only available when Clock 1 (year/month/day) has been set.

**Acknowledgment**

(x)( )(Set ID)( )(OK/NG)(Data1)(Data2)(Data3)(x)

**18. [No Signal Power Off(15Min)] (Command: f g)**

Sets the monitor to enter Automatic Standby mode if there is no signal for 15 minutes.

**Transmission**

(f)(g)( )(Set ID)( )(Data)(Cr)

Data 00: [Off]

01: [On]

**Acknowledgment**

(g)( )(Set ID)( )(OK/NG)(Data)(x)

**19. [No IR Power Off] (Command: m n)**

Activates Auto Power Off when there is no IR signal for 4 hours.

**Transmission**

(m)(n)( )(Set ID)( )(Data)(Cr)

Data 00: [Off]

01: [On]

**Acknowledgment**

(n)( )(Set ID)( )(OK/NG)(Data)(x)

**20. [Language] (Command: f i)**

Sets the OSD language.

**Transmission**

(f)(i)( )(Set ID)( )(Data)(Cr)

Data 00: Czech

01: Danish

02: German

03: English

04: Spanish (Europe)

05: Greek

06: French

07: Italian

08: Dutch

09: Norwegian

0A: Portuguese

0B: Portuguese (Brazil)

0C: Russian

0D: Finnish

0E: Swedish

0F: Korean

10: Chinese (Mandarin)

11: Japanese

12: Chinese (Cantonese)

13: Arabic

14: Turkish

**Acknowledgment**

(i)( )(Set ID)( )(OK/NG)(Data)(x)

\* Some languages may not be available for all models.

**21. [Default] Settings (Command: f k)**

Executes Reset.

(Initialize Screen can only be executed in RGB input mode.)

**Transmission**

(f)(k)( )(Set ID)( )(Data)(Cr)

Data 00: [Picture Reset]

02: [Reset to Initial Settings]

**Acknowledgment**

(k)( )(Set ID)( )(OK/NG)(Data)(x)

\* This feature may not be available for all models.

**22. Current Temperature (Command: d n)**

Checks the current temperature of the product.

**Transmission**

(d)(n)( )(Set ID)( )(Data)(Cr)

Data FF: Status Check

**Acknowledgment**

(n)( )(Set ID)( )(OK/NG)(Data)(x)

\* The temperature is displayed in hexadecimal.

**23. [Key] (Command: m c)**

Sends a key code for the IR remote control.

**Transmission**

(m)(c)( )(Set ID)( )(Data)(Cr)

Data IR\_KEY\_CODE

**Acknowledgment**

(c)( )(Set ID)( )(OK/NG)(Data)(x)

\* For key codes, see IR Codes.

\* Some key codes may not be supported depending on the model.

**24. Time Elapsed (Command: d l)**

Displays the time that has elapsed after your monitor has turned on.

**Transmission**

(d)(l)( ) (Set ID)( ) (Data)(Cr)

Data FF: Read status

**Acknowledgment**

(l)( ) (Set ID)( ) (OK/NG)(Data)(x)

\* The data received is displayed in hexadecimal.

**25. Product Serial Number Check (Command: f y)**

Checks the serial number of the product.

**Transmission**

(f)(y)( ) (Set ID)( ) (Data)(Cr)

Data FF: Check product serial number

**Acknowledgment**

(y)( ) (Set ID)( ) (OK/NG)(Data)(x)

\* Data is in ASCII format.

**26. [Software Version] (Command: f z)**

Checks the software version of the product.

**Transmission**

(f)(z)( ) (Set ID)( ) (Data)(Cr)

Data FF: Check the software version

**Acknowledgment**

(z)( ) (Set ID)( ) (OK/NG)(Data)(x)

**27. [White Balance] Red Gain (Command: j m)**

Adjusts the red gain value for white balance.

**Transmission**

(j)(m)( ) (Set ID)( ) (Data)(Cr)

Data 00-FE: Red Gain 0-254

FF: Checks red gain value

**Acknowledgment**

(m)( ) (Set ID)( ) (OK/NG)(Data)(x)

**28. [White Balance] Green Gain (Command: j n)**

Adjusts the green gain value for white balance.

**Transmission**

(j)(n)( ) (Set ID)( ) (Data)(Cr)

Data 00-FE: Green Gain 0-254

FF: Checks green gain value

**Acknowledgment**

(n)( ) (Set ID)( ) (OK/NG)(Data)(x)

**29. [White Balance] Blue Gain (Command: j o)**

Adjusts the blue gain value for white balance.

**Transmission**

(j)(o)( ) (Set ID)( ) (Data)(Cr)

Data 00-FE: Blue Gain 0-254

FF: Checks blue gain value

**Acknowledgment**

(o)( ) (Set ID)( ) (OK/NG)(Data)(x)

**30. [White Balance] Red Offset (Command: s x)**

Adjusts the red offset value for white balance.

**Transmission**

(s)(x)( )(Set ID)( )(Data)(Cr)

Data 00-7F: Red Offset 0-127

FF: Checks red offset value

**Acknowledgment**

(x)( )(Set ID)( )(OK/NG)(Data)(x)

**31. [White Balance] Green Offset (Command: s y)**

Adjusts the green offset value for white balance.

**Transmission**

(s)(y)( )(Set ID)( )(Data)(Cr)

Data 00-7F: Green Offset 0-127

FF: Checks green offset value

**Acknowledgment**

(y)( )(Set ID)( )(OK/NG)(Data)(x)

**32. [White Balance] Blue Offset (Command: s z)**

Adjusts the blue offset value for white balance.

**Transmission**

(s)(z)( )(Set ID)( )(Data)(Cr)

Data 00-7F: Blue Offset 0-127

FF: Checks blue offset value

**Acknowledgment**

(z)( )(Set ID)( )(OK/NG)(Data)(x)

**33. [Backlight] (Command: m g)**

Adjusts the backlight brightness.

**Transmission**

(m)(g)( )(Set ID)( )(Data)(Cr)

Data 00-64: Backlight 0-100

**Acknowledgment**

(g)( )(set ID)( )(OK/NG)(Data)(x)

**34. [SCREEN OFF] (Command: k d)**

Turns off/off the screen.

**Transmission**

(k)(d)( )(Set ID)( )(Data)(Cr)

Data 00: Screen On

01: Screen Off

**Acknowledgment**

(d)( )(Set ID)( )(OK/NG)(Data)(x)

\* This feature may not be available for all models.

**35. [Tile Mode] (Command: d d)**

Sets a tile mode and values for the tile rows and columns.

**Transmission**

(d)(d)( )(Set ID)( )(Data)(Cr)

Data 00-FF: The first byte - tile column

The second byte - tile row

\* 00, 01, 10, and 11 mean that the tile mode is off.

\* The maximum value may differ depending on the model.

**Acknowledgment**

(d)( )(Set ID)( )(OK/NG)(Data)(x)

\* This feature may not be available for all models.

\* If you change the values on a Video Wall model, please reboot for it to work normally.

**36. [Tile Mode] Check (Command: d z)**

Checks the tile mode.

**Transmission****(d)(z)( )(Set ID)( )(Data)(Cr)**

Data FF: Check Tile Mode

**Acknowledgment****(z)( )(Set ID)( )(OK/NG)(Data1)(Data2)(Data3)(x)**Data1 00: Tile Mode off  
01: Tile Mode on

Data2 00-0F: Tile column

Data3 00-0F: Tile row

\* This feature may not be available for all models.

**37. [Tile ID] (Command: d i)**

Sets the tile ID value of the product.

**Transmission****(d)(i)( )(Set ID)( )(Data)(Cr)**Data 01-E1: Tile ID 1-225  
FF: Checks the Tile ID

\* The data value cannot exceed the value of row x column.

**Acknowledgment****(i)( )(Set ID)( )(OK/NG)(Data)(x)**

\* If you enter a value that exceeds the value of row x column for the Data parameter (except for 0xFF), Ack becomes NG.

\* This feature may not be available for all models.

\* If you change the values on a Video Wall model, please reboot for it to work normally.

**38. [Natural Mode] (In Tile Mode) (Command: d j)**

To display the image naturally, the part of the image that would normally be displayed in the gap between the monitors is omitted.

**Transmission****(d)(j)( )(Set ID)( )(Data)(Cr)**Data 00: [Off]  
01: [On]**Acknowledgment****(j)( )(Set ID)( )(OK/NG)(Data)(x)**

\* This feature may not be available for all models.

**39. [DPM] / [DPM (Standby Mode)] (Command: f j)**

Sets the DPM(Display Power Management) function.

**Transmission****(f)(j)( )(Set ID)( )(Data)(Cr)**Data 00: [Off]  
02: 10 seconds  
04: 1 minute  
05: 3 minutes  
06: 5 minutes  
07: 10 minutes**Acknowledgment****(j)( )(Set ID)( )(OK/NG)(Data)(x)**

\* This feature may not be available for all models.

**40. Remote Control/Local Key Operation Lock (Command: k m)**

Adjusts the remote control/local key (front) lock.

**Transmission****(k)(m)( )(Set ID)( )(Data)(Cr)**Data 00: [Off] (Lock Off)  
01: [On] (Lock On)

\* When the monitor is turned off, the power key works even in On (01) mode.

**Acknowledgment****(m)( )(Set ID)( )(OK/NG)(Data)(x)**

\* This feature may not be available for all models.

**41. [Power On Delay] (Command: f h)**

Sets the schedule delay for when the power turns on. (Unit: seconds)

**Transmission****(f)(h)( )(Set ID)( )(Data)(Cr)**

Data 00-FA: Min 0- Max 250 (sec)

**Acknowledgment****(h)( )(Set ID)( )(OK/NG)(Data)(x)**

\* The maximum value may differ depending on the model.

**42. [Fail Over] Mode (Command: m i)**

Selects a sound mode.

**Transmission**

(m)(i)( ) (Set ID)( ) (Data)(Cr)

Data 00: [Off]  
01: [Auto]  
02: [User Setting]

**Acknowledgment**

(i)( ) (Set ID)( ) (OK/NG)(Data)(x)

**43. [Fail Over] Input Select (Command: m j)**

Selects an input source for fail over. (This feature is only available when Fail Over is set to Custom.)

**Transmission**

(m)(j)( ) (Set ID)( ) (Data1)( ) (Data2)( ) (Data3)( ) (Data4)

... ( ) (DataN)(Cr)

Data1-N (Input priority 1-N)  
60: RGB  
70: DVI-D  
90: HDMI1  
91: HDMI2  
92: OPS/HDMI3/DVI-D  
95: OPS/DVI-D  
96: HDMI3/DVI-D  
97: HDMI3/HDMI2/DVI-D  
98: OPS  
99: HDMI2/OPS  
C0: DISPLAYPORT  
C1: DISPLAYPORT/USB-C  
C2: HDMI3  
C3: HDBaseT

**Acknowledgment**

(j)( ) (Set ID)( ) (OK/NG)(Data1)(Data2)(Data3)(Data4)

... (DataN)(x)

- \* Some input signals may not be available for all models.
- \* The data number (N) may vary depending on the model. (The data number depends on the number of supported input signals.)
- \* This feature operates as the last input, and supports data in DTV format.

**44. Remote Control Key Lock (Command: t p)**

Configures the settings of the product's remote control key.

**Transmission**

(t)(p)( ) (Set ID)( ) (Data)(Cr)

Data 00: Unlocks all keys  
01: Locks all keys except Power key  
02: Locks all keys

**Acknowledgment**

(p)( ) (Set ID)( ) (OK/NG)(Data)(x)

- \* When the monitor is turned off, the power key works even in the locks on all of the keys (02) mode.

**45. [Local Key Operation Lock] (Command: t o)**

Configures the local key operation settings of the product.

**Transmission**

(t)(o)( ) (Set ID)( ) (Data)(Cr)

Data 00: Unlocks all keys  
01: Locks all keys except Power key  
02: Locks all keys

**Acknowledgment**

(o)( ) (Set ID)( ) (OK/NG)(Data)(x)

- \* When the monitor is turned off, the power key works even in the locks on all of the keys (02) mode.
- \* This feature may not be available for all models.

**46. Status Check (Command: s v)**

Checks the current signal of the product.

**Transmission****(s)(v)( ) (Set ID)( ) (Data)( ) (FF)(Cr)**

- Data 02: Check whether there is a signal  
 03: The monitor is currently in PM Mode  
 07: Checks whether the Top, Bottom and Main temperature sensors are functioning normally.  
 09: Fan Speed  
 10: RGB Sensing OK/NG (screen fault detection)  
 16: Check the humidity value  
 17: Check the value of the intensity of illumination  
 18: Check the status value of the slope of the product

**Acknowledgment****(v)( ) (Set ID)( ) (OK/NG)(Data)(Data1)(x)**

- Data 02 (when a signal is found)  
 Data1 00: No signal  
 01: Signal present
- Data 03 (when the monitor is currently in PM mode)  
 Data1 00: Screen is on  
 01: Screen is off  
 02: Screen Off Always is activated  
 03: Sustain Aspect Ratio is activated  
 04: Screen Off & Backlight On is activated
- Data 07 (when checking whether the Top, Bottom and Main temperature sensors are working properly)  
 Data1 00: All temperature sensors are faulty  
 01: Top normal, Bottom faulty, Main faulty  
 02: Top faulty, Bottom normal, Main faulty  
 03: Top normal, Bottom normal, Main faulty  
 04: Top faulty, Bottom faulty, Main normal  
 05: Top normal, Bottom faulty, Main normal  
 06: Top faulty, Bottom normal, Main normal  
 07: All temperature sensors are normal
- Data 10 (when executing Screen Fault Detection)  
 Data 1 00: Screen Fault Detection result NG  
 07: Screen Fault Detection result OK
- \* When screen Fault Detection is set to Off or not supported, execution results are rendered "NG."
- Data 16 (for checking the humidity value)  
 Data 1 0~100: Reads the %RH value of the current humidity (indicated as a Hex value).
- Data 17 (for checking the value of the intensity of illumination)  
 Data 1 1~1000: Reads the Lux value of the current intensity of illumination (indicated as a Hex value).
- Data 18 (for checking the status value of the slope of the product)  
 Data 1 00: 0 degrees  
 01: 90 degrees  
 02: 180 degrees  
 03: 270 degrees  
 04: Fallen forward  
 05: Fallen backward

Data 09 (when checking the fan speed)

**Acknowledgement****(v)( ) (Set ID)( ) (OK/NG)(Data)(Data1\_1)(Data1\_2)**

- ...(DataN\_1)(DataN\_2)(x)**
- Data1\_1: 00-ff: First fan speed top 1 Byte  
 Data1\_2: 00-ff: First fan speed bottom 1 Byte  
 ...  
 DataN\_1: 00-ff: Nth fan speed top 1 Byte  
 DataN\_2: 00-ff: Nth fan speed bottom 1 Byte

Fan Speed: Hex 0~2008, Decimal 0~8200

\* The data number (N) may vary depending on the model.

\* This feature may not be available for all models.

**47. [Daylight Saving Time] (Command: s d)**

Sets Daylight Savings Time.

**Transmission****(s)(d)( ) (Set ID)( ) (Data1)( ) (Data2)( ) (Data3)( ) (Data4)( ) (Data5)( ) (Cr)**

- Data1 00: Off (Data2-5: FF)  
 01: Start Time  
 02: End Time  
 Data2 01~0C: January - December  
 Data3 01~06: Week 1 - 6
- \* The maximum value of [Data3] may vary depending on the date.
- Data4 00~06: (Sunday - Saturday)  
 Data5 00~17: 00 - 23 hours
- \* If you wish to read the start/end times, enter FF for parameters [Data2] through [Data5].  
 (Example 1: sd 01 01 ff ff ff ff - Checks the start time.  
 Example 2: sd 01 02 ff ff ff ff - Checks the end time.)
- \* This feature only works when Clock 1 (year/month/day) and Clock 2 (hour/minute/second) have been set.

**Acknowledgment****(d)( ) (Set ID)( ) (OK/NG)(Data1)(Data2) (Data3)(Data4)(Data5)(x)**

\* This feature may not be available for all models.

**48. [PM Mode] (Command: s n, 0c)**

Sets the PM mode.

**Transmission****(s)(n)( ) (Set ID)( ) (Oc)( ) (Data)(Cr)**

Data 00: [Power Off] (Basic)  
 01: [Sustain Aspect Ratio]  
 02: [Screen Off]  
 03: [Screen Off Always]  
 04: [Screen Off & Backlight On]  
 05: [Network Ready]

**Acknowledgment****(n)( ) (Set ID)( ) (OK/NG)(Oc)(Data)(x)**

\* This feature may not be available for all models.

**49. [ISM Method] (Command: j p)**

Selects an ISM method.

**Transmission****(j)(p)( ) (Set ID)( ) (Data)(Cr)**

Data 02: [Orbiter]  
 04: [White Wash]  
 08: [Off]  
 90: [User Image]  
 91: [User Video]

**Acknowledgment****(p)( ) (Set ID)( ) (OK/NG)(Data)(x)**

\* This feature may not be available for all models.

\* "02: [Orbiter]" is not supported while "91: [User Video]" is turned on.

**50. [Network Setting] (Command: s n, 80 or 81 or 82)**

Configures network and DNS settings.

**Transmission****(s)(n)( ) (Set ID)( ) (Data1)( ) (Data2)( ) (Data3)( ) (Data4)( ) (Data5)(Cr)**

Data1 80: Configures/views the temporary IP mode (Auto/Manual), subnet mask, and gateway.  
 81: Configures/views the temporary DNS address.  
 82: Saves temporary settings and views information about the current network.

\* If Data1 is 80,

Data2 00: Auto  
 01: Manual  
 FF: Views the temporary IP mode (Auto/Manual), subnet mask, and gateway.

\* If Data2 is 01 (Manual),

Data3 Manual IP address  
 Data4 Subnet mask address  
 Data5 Gateway address

\* If Data1 is 81,

Data2 DNS address  
 FF: Displays the temporary DNS address.

\* If Data1 is 82,

Data2 80: Applies the temporary IP mode (Auto/Manual), subnet mask, and gateway.  
 81: Applies the temporary DNS address  
 FF: Information on the current network (IP, subnet gateway and DNS)

\* An example of settings,

1. Auto: sn 01 80 00
2. Manual: sn 01 80 01 010177223241 255255254000 010177222001 (IP:10.177.223.241, subnet: 255.255.254.0, gateway: 10.177.222.1)
3. Network read: sn 01 80 ff
4. DNS setting: sn 01 81 156147035018 (DNS: 156.147.35.18)
5. Applying the settings: sn 01 82 80 (applies the saved IP mode (auto/manual), subnet mask, and gateway), sn 01 82 81 (applies the saved DSN)

\* Each IP address contains 12 decimal digits.

**Acknowledgment****(n)( ) (Set ID)( ) (OK/NG)(Data1)(Data)(x)**

\* This feature is available only for wired networks.

\* This feature may not be available for all models.

**51. [Power On Status] (Command: t r)**

Sets the Power On status of the monitor.

**Transmission**

(t)(r)( ) (Set ID)( ) (Data)(Cr)

Data 00: [LST(Last Status)]  
01: [STD(Standby)]  
02: [PWR(Power On)]**Acknowledgment**

(r)( ) (Set ID)( ) (OK/NG)(Data)(x)

**52. Wired [Wake On LAN] / [Wake On LAN (Networked Standby Mode)] (Command: f w)**

Selects a Wired Wake On LAN option.

**Transmission**

(f)(w)( ) (Set ID)( ) (Data)(Cr)

Data 00: [Off]  
01: [On]**Acknowledgment**

(w)( ) (Set ID)( ) (OK/NG)(Data)(x)

**53. [OSD Rotation] (Command: t h)**

Sets the Screen Rotation feature.

**Transmission**

(t)(h)( ) (Set ID)( ) (Data) (Cr)

Data 00: [Off]  
01: 90 degrees  
02: 270 degrees  
03: 180 degrees**Acknowledgment**

(h)( ) (Set ID)( ) (OK/NG)(Data)(x)

\* This feature may not be available for all models.

**54. [Time Sync] (Command: s n, 16)**

Sets Time Sync.

**Transmission**

(s)(n)( ) (Set ID)( ) (1)(6)( ) (Data)(Cr)

Data 00: [Off]  
01: [On]

- \* This feature only works when the monitor is in Master mode.
- \* This feature does not work if the current time is not set.

**Acknowledgment**

(n)( ) (Set ID)( ) (OK/NG)(1)(6)(Data)(x)

\* This feature may not be available for all models.

**55. [Contents Sync] (Command: t g)**

Sets Content Sync.

**Transmission**

(t)(g)( ) (Set ID)( ) (Data)(Cr)

Data 00: [Off]  
01: [On]**Acknowledgment**

(g)( ) (Set ID)( ) (OK/NG)(Data)(x)

\* This feature may not be available for all models.

**56. [LAN Daisy Chain] (Command: s n, 84)**

Turns on/off LAN Daisy Chain.

**Transmission**

(s)(n)( ) (Set ID)( ) (8)(4)( ) (Data)(Cr)

Data 00: [Off]  
01: [On]**Acknowledgment**

(n)( ) (Set ID)( ) (OK/NG)(8)(4)(Data)(x)

\* This feature may not be available for all models.

**57. [External Input Rotation] (Command: s n, 85)**

Sets the External Input Rotation feature.

**Transmission**`(s)(n)( )(Set ID)( )(8)(5)( )(Data)(Cr)`

Data 00: [Off]  
 01: 90 degrees  
 02: 270 degrees  
 03: 180 degrees

**Acknowledgment**`(n)( )(Set ID)( )(OK/NG)(8)(5)(Data)(x)`

\* This feature may not be available for all models.

**58. [Beacon] (Command: s n, 88)**

Turns on/off Beacon.

**Transmission**`(s)(n)( )(Set ID)( )(8)(8)( )(Data)(Cr)`

Data 00: [Off]  
 01: [On]

**Acknowledgment**`(n)( )(Set ID)( )(OK/NG)(8)(8)(Data)(x)`

\* This feature may not be available for all models.

**59. [Brightness Scheduling] Mode (Command: s m)**

Selects a Brightness Scheduling mode.

**Transmission**`(s)(m)( )(Set ID)( )(Data)(Cr)`

Data 00: [Off]  
 01: [On]

**Acknowledgment**`(m)( )(Set ID)( )(OK/NG)(Data)(x)`

\* This feature does not work if the current time is not set.

\* This feature may not be available for all models.

**60. [Brightness Scheduling] (Command: s s)**

Sets Brightness Scheduling.

**Transmission**`(s)(s)( )(Set ID)( )(Data1)( )(Data2)( )(Data3)(Cr)`

Data 1  
 1. f1 to f6 (data reading)  
 F1: Reads the 1st brightness schedule's data  
 F2: Reads the 2nd brightness schedule's data.  
 F3: Reads the 3rd brightness schedule's data.  
 F4: Reads the 4th brightness schedule's data.  
 F5: Reads the 5th brightness schedule's data.  
 F6: Reads the 6th brightness schedule's data.

2. FF: Reads all stored lists

3. e1 to e6 (Deletes one index), e0 (Deletes all indexes)  
 E0: Deletes all brightness schedules.  
 E1: Deletes the 1st brightness schedule.  
 E2: Deletes the 2nd brightness schedule.  
 E3: Deletes the 3rd brightness schedule.  
 E4: Deletes the 4th brightness schedule.  
 E5: Deletes the 5th brightness schedule.  
 E6: Deletes the 6th brightness schedule.

4. 00-17: 00 - 23 hours

Data 2 00-3B: 00 - 59 minutes

Data 3 00-64: Backlight 0 - 100

\* To read or delete a brightness schedule you have set, (Data2) (Data3) must be set to FF.

\* If you want to read all configured brightness schedules through FF, do not enter any values in (Data2)(Data3).

\* When retrieving all items of the set Brightness Scheduling list through FF, OK will be acknowledged (ACK) even if there is no saved list.

ex1: ss 01 f1 ff ff - Reads the 1st index data in Brightness Schedule.

ex2: ss 01 ff - Reads all index data in Brightness Schedule.

ex3: ss 01 e1 ff ff - Deletes the 1st index data in Brightness Schedule.

ex4: ss 01 07 1E 46 - Adds a schedule whose time is 07:30 and whose backlight is 70.

**Acknowledgement**`(s)( )(Set ID)( )(OK/NG)(Data1)(Data2)(Data3)(x)`

\* This feature may not be available for all models.

**61. [Multi Screen] Mode & Input (Command: x c)**

Saves and controls Multi Screen modes and inputs.

**Transmission****(x)(c)( ) (Set ID)( ) (Data1)( ) (Data2)( ) (Data3)( ) (Data4)( ) (Data5)( ) (Cr)**

Data1 (Sets MultiScreen mode)

- 10: PIP
- 22: PBP2
- 23: PBP3
- 24: PBP4
- 25: PBP3 (1:2:1)

Data2 (Sets the Main input of Multi screen)

Data3 (Sets the Sub1 input of Multi screen)

Data4 (Sets the Sub2 input of Multi screen)

Data5 (Sets the Sub3 input of Multi screen)

- 80: DVI-D
- 90: HDMI1
- 91: HDMI2
- 92: OPS/HDMI3/DVI-D
- 95: OPS/DVI-D
- 96: HDMI3/DVI-D
- 97: HDMI3/HDMI2/DVI-D
- 98: OPS
- 99: HDMI2/OPS
- C0: DISPLAYPORT
- C1: DISPLAYPORT/USB-C
- C2: HDMI3
- C3: HDBaseT

**Acknowledgment****(c)( ) (Set ID)( ) (OK/NG)( ) (Data1)(Data2)(Data3)(Data4)(Data5)(x)**

- \* This feature may not be available for all models.
- \* Only the input modes supported by the model works.
- \* This feature operates as the last input, and supports data in DTV format.
- \* When the Read operation is performed, 00 is returned if it is not for an external input.

**62. [Aspect Ratio] (Multi screen) (Command: x d)**

Controls the aspect ratio of Multi Screen.

**Transmission****(x)(d)( ) (Set ID)( ) (Data1)( ) (Data2)(Cr)**

- Data1 01: Controls the Main input
- 02: Controls the Sub1 input
- 03: Controls the Sub2 input
- 04: Controls the Sub3 input
- Data2 00: Full Screen
- 01: Original

**Acknowledgment****(d)( ) (Set ID)( ) (OK/NG)(Data1)(Data2)(x)**

- \* This feature may not be available for all models.

**63. [SCREEN OFF] (Multi screen) (Command: x e)**

Turns on/off each screen in the Multi Screen.

**Transmission****(x)(e)( ) (Set ID)( ) (Data1)( ) (Data2)(Cr)**

- Data1 01: Controls the Main input
- 02: Controls the Sub1 input
- 03: Controls the Sub2 input
- 04: Controls the Sub3 input
- Data2 00: Screen On
- 01: Screen Off

- \* This feature only works when the Multi Screen app is running.
- \* This feature does not work when there is no signal.

**Acknowledgment****(e)( ) (Set ID)( ) (OK/NG)(Data1)(Data2)(x)**

- \* This feature may not be available for all models.

**64. [Screen Off Always] (Command: s n, 0d)**

If you activate the Screen Off Always feature, the monitor enters Screen Off mode regardless of whether or not you have activated PM mode.

**Transmission****(s)(n)( ) (Set ID)( ) (0)(d)( ) (Data)(Cr)**

- Data 00: [Off]
- 01: [On]

**Acknowledgment****(n)( ) (Set ID)( ) (OK/NG)(0)(d)(Data)(x)**

- \* This feature may not be available for all models.

**65. Stop Video (Command: k x)**

Controls Stop Video.

**Transmission**`(k)(x)( ) (Set ID)( ) (Data)(Cr)`Data 00: The Stop Video feature is on.  
01: The Stop Video feature is off.

\* This feature only works in single input mode.

**Acknowledgment**`(x)( ) (Set ID)( ) (OK/NG)(Data)(x)`

\* This feature may not be available for all models.

**66. Wireless [Wake On LAN] / [Wake On LAN (Networked Standby Mode)] (Command: s n, 90)**

Sets the Wireless Wake-on-LAN feature.

**Transmission**`(s)(n)( ) (Set ID)( ) (9)(0)( ) (Data)(Cr)`Data 00: [Off]  
01: [On]**Acknowledgment**`(n)( ) (Set ID)( ) (OK/NG)(9)(0)(Data)(x)`

\* This feature may not be available for all models.

**67. [OSD Lock] (Command: k l)**

Sets OSD Lock.

**Transmission**`(k)(l)( ) (Set ID)( ) (Data)(Cr)`Data 00: OSD Lock  
01: Unlock OSD Lock**Acknowledgment**`(l)( ) (Set ID)( ) (OK/NG)(Data)(x)`**68. [HDMI IT Content] (Command: s n, 99)**

Automatically sets the picture mode based on HDMI data.

**Transmission**`(s)(n)( ) (Set ID)( ) (9)(9)( ) (Data)(Cr)`Data 00: [Off]  
01: [On]**Acknowledgment**`(n)( ) (Set ID)( ) (OK/NG)(9)(9)(Data)(x)`

\* This feature may not be available for all models.

**69. [Holiday Setting] (Command: s n, 9b)**

Sets holidays.

**Transmission**`1. (s)(n)( ) (Set ID)( ) (9)(b)( ) (Data1)( ) (Data2)( ) (Data3)( ) (Data4)( ) (Data5)( ) (Data6)(Cr)``2. (s)(n)( ) (Set ID)( ) (9)(b)( ) (Data1)( ) (Data2)(Cr)`  
`3. (s)(n)( ) (Set ID)( ) (9)(b)( ) (Data1)(Cr)`

## 1. Setting a Holiday

Data1 Start year

00-: 2010-

Data2 Start month

01 - 0c: January - December

Data3 Start date

01 - 1F: 01-31

Data4 For how long from the start year/month/date

01-07: For 1 to 7 days

Data5 Repetition

00: None

01: Every month

02: Every Year

Data6 Repeats the schedule on a date/day-of-the-week basis.

01: On a date basis.

02: On a day-of-the-week basis.

\* The minimum and maximum values for Data1 differ depending on the product's release year.

\* You can input a value for [Data 6] only when a value has already been set for [Data 5] (every year or every month).

## 2. Checking a Schedule

Data1 Select the desired schedule.

F1: Reads the 1st schedule

F2: Reads the 2nd schedule

F3: Reads the 3rd schedule

F4: Reads the 4th schedule

F5: Reads the 5th schedule

F6: Reads the 6th schedule

F7: Reads the 7th schedule

Data2

FF

## 3. Deleting a Schedule

- E0: Deletes all holiday schedules
- E1: Deletes the 1st holiday schedule
- E2: Deletes the 2nd holiday schedule
- E3: Deletes the 3rd holiday schedule
- E4: Deletes the 4th holiday schedule
- E5: Deletes the 5th holiday schedule
- E6: Deletes the 6th holiday schedule
- E7: Deletes the 7th holiday schedule

\* This feature does not work if the current time is not set.

## Acknowledgment

1. (n)(Set ID)(OK/NG)(9)(b)(Data1)(Data2)(Data3)(Data4)(Data5)(Data6)(x)
2. (n)(Set ID)(OK/NG)(9)(b)(f)(1~7)(Data1)(Data2)(Data3)(Data4)(Data5)(Data6)(x)
3. (n)(Set ID)(OK/NG)(9)(b)(Data1)(x)

\* This feature may not be available for all models.

## 70. [UPnP] (Command: s n, 9c)

Sets UPnP mode.

## Transmission

(s)(n)(Set ID)(9)(c)(Data)(Cr)

Data 00: [Off]

01: [On]

## Acknowledgment

(n)(Set ID)(OK/NG)(9)(c)(Data)(x)

\* This feature may not be available for all models.

\* Changing UPnP mode results in a reboot.

## 71. [Home Dashboard Lock] (Command: s n, 9d)

Sets Home Dashboard Lock.

## Transmission

(s)(n)(Set ID)(9)(d)(Data)(Cr)

Data 00: Home Dashboard Unlock

01: Home Dashboard Lock

## Acknowledgment

(n)(Set ID)(OK/NG)(9)(d)(Data)(x)

\* This feature may not be available for all models.

## 72. [USB Lock] (Command: s n, 9e)

Sets USB Lock.

## Transmission

(s)(n)(Set ID)(9)(e)(Data)(Cr)

Data 00: USB Unlock

01: USB Lock

## Acknowledgment

(n)(Set ID)(OK/NG)(9)(e)(Data)(x)

\* This feature may not be available for all models.

**73. [Wi-Fi Lock] (Command: s n, 9f)**

Sets Wi-Fi Lock.

**Transmission**`(s)(n)( )(Set ID)( )(9)(f)( )(Data)(Cr)`Data 00: Wi-Fi Unlock  
01: Wi-Fi Lock**Acknowledgment**`(n)( )(Set ID)( )(OK/NG)(9)(f)(Data)(x)`

\* This feature may not be available for all models.

**74. [Screen Share Lock] (Command: s n, a0)**

Sets Screen Share Lock.

**Transmission**`(s)(n)( )(Set ID)( )(a)(0)( )(Data)(Cr)`Data 00: Screen Share Unlock  
01: Screen Share Lock**Acknowledgment**`(n)( )(Set ID)( )(OK/NG)(a)(0)(Data)(x)`

\* This feature may not be available for all models.

\* Changing Screen Share Lock mode results in a reboot.

**75. See [Backup via Storage] (Command: s n, a1)**

Sets Backup via Storage.

**Transmission**1. `(s)(n)( )(Set ID)( )(a)(1)( )(Data1)(Cr)`2. `(s)(n)( )(Set ID)( )(a)(1)( )(Data1)(Data2)(Cr)`

1. Disabling Backup via Storage.

Data1 00: Off

2. Setting Backup via Storage to Auto

Data1 01: Auto

Data2 01: 30 minute

02: 1 hour

03: 2 hours

04: 3 hours

3. Setting Backup via Storage to Manual

Data1 02: Manual

4. Setting Backup via Storage to SuperSign Content

Data1 03: SuperSign Contents

5. Set to SI App / Play via URL

Data 1 04: [SI App / Play via URL]

**Acknowledgment**1. `(n)( )(Set ID)( )(OK/NG)(a)(1)(Data1)(x)`2. `(n)( )(Set ID)( )(OK/NG)(a)(1)(Data1)(Data2)(x)`

\* This feature may not be available for all models.

**76. [Digital Audio Input] (Command: s n, a2)**

Sets Digital Audio Input.

**Transmission**`(s)(n)( )(Set ID)( )(a)(2)( )(Data)(Cr)`Data 00: Digital  
01: Analog**Acknowledgment**`(n)( )(Set ID)( )(OK/NG)(a)(2)(Data)(x)`

\* This feature may not be available for all models.

**77. [Bootling Logo Image] (Command: s n, a3)**

Sets Bootling Logo Image.

**Transmission**`(s)(n)( )(Set ID)( )(a)(3)( )(Data)(Cr)`Data 00: [Off]  
01: [On]**Acknowledgment**`(n)( )(Set ID)( )(OK/NG)(a)(3)(Data)(x)`

\* This feature may not be available for all models.

**78. [SoftAP] (Command: s n, a4)**

Sets SoftAP Mode.

**Transmission**`(s)(n)( )(Set ID)( )(a)(4)( )(Data)(Cr)`Data 00: [Off]  
01: [On]**Acknowledgment**`(n)( )(Set ID)( )(OK/NG)(a)(4)(Data)(x)`

\* This feature may not be available for all models.

**79. [Natural Size] (Command: s n, a5)**

Sets the Natural Size feature.

**Transmission**`(s)(n)( )(Set ID)( )(a)(5)( )(Data)(Cr)`

Data 00-64: Natural Size 0 - 100

**Acknowledgment**`(n)( )(Set ID)( )(OK/NG)(a)(5)(Data)(x)`

\* This feature may not be available for all models.

**80. Play Saved Internal Media (Command: s n, a8)**

Plays media files saved on internal storage. Internal storage media: videos and images stored on the monitor's internal storage after being exported via Contents Management Player.

\* Not applicable: Template content, SuperSign content, and playlist content.

**Transmission**`(s)(n)( )(Set ID)( )(a)(8)( )(Data)(Cr)`

Data 01: Play

**Acknowledgment**`(n)( )(Set ID)( )(OK/NG)(a)(8)( )(Data)(x)`

\* This feature may not be available for all models.

**81. [No Signal Image] (Command: s n, a9)**

Sets the No Signal Image feature.

**Transmission**`(s)(n)( )(Set ID)( )(a)(9)( )(Data)(Cr)`Data 00: [Off]  
01: [On]**Acknowledgment**`(n)( )(Set ID)( )(OK/NG)(a)(9)(Data)(x)`

\* This feature may not be available for all models.

**82. [Audio Out] (Command: s n, aa)**

Sets Audio Out to Off/Variable/Fixed.

**Transmission**`(s)(n)( )(Set ID)( )(a)(a)( )(Data)(Cr)`

Data 00: [Off]  
 01: [Variable]  
 02: [Fixed]

**Acknowledgment**`(n)( )(Set ID)( )(OK/NG)(a)(a)(Data)(x)`

\* This feature may not be available for all models.

**85. [Apply to all inputs] (Command: s n, 52)**

Apply the video mode and low value of the current input to the same video value of all inputs.

**Transmission**`(s)(n)( )(Set ID)( )(5)(2)( )(Data)(Cr)`

Data 01: Apply

**Acknowledgment**`(n)( )(Set ID)( )(OK/NG)(5)(2)(Data)(x)`

\* This feature may not be available for all models.

\* Other commands do not work for a certain time after applying.

**83. [DPM Wake Up Control] / [DPM (Standby Mode) Wake Up Control] (Command: s n, 0b)**

Controls the DPM Wake Up Control settings.

**Transmission**`(s)(n)( )(Set ID)( )(0)(b)( )(Data)(Cr)`

Data 00: [Clock]  
 01: [Clock+DATA]

**Acknowledgment**`(n)( )(Set ID)( )(OK/NG)(0)(b)(Data)(x)`

\* This feature may not be available for all models.

**86. [Timer Power On] Scheduling (Command: f d)**

Sets On Timer settings.

**Transmission**`(f)(d)( )(Set ID)( )(Data1)( )(Data2)( )(Data3)(Cr)`

Data1

1. f1h to f7h (data reading)

F1: Reads the 1st Timer Power On's data

F2: Reads the 2nd Timer Power On's data

F3: Reads the 3rd Timer Power On's data

F4: Reads the 4th Timer Power On's data

F5: Reads the 5th Timer Power On's data

F6: Reads the 6th Timer Power On's data

F7: Reads the 7th Timer Power On's data

2. e1h to e7h (Deletes one index), e0h (Deletes all indexes)

E0: Delete all Timer Power On's

E1: Delete the 1st Timer Power On

E2: Delete the 2nd Timer Power On

E3: Delete the 3rd Timer Power On

E4: Delete the 4th Timer Power On

E5: Delete the 5th Timer Power On

E6: Delete the 6th Timer Power On

E7: Delete the 7th Timer Power On

**84. [Fan] Failure Check (Command: d w)**

Check the fan malfunction.

**Transmission**`(d)(w)( )(Set ID)( )(Data)(Cr)`

Data FF: Read status

**Acknowledgment**`(w)( )(Set ID)( )(OK/NG)(Data1)(Data2)(x)`

Data1 00: Fan failure  
 01: Fan normal

Data2 00: 0 faults (Fan Normal)  
 01: 1 fault  
 02: 2 faults  
 03: 3 faults  
 04: 4 faults  
 05: 5 faults  
 06: 6 faults  
 07: 7 faults  
 08: 8 faults  
 09: 9 faults  
 0A: 10 faults

\* This feature may not be available for all models.

3. 01h to 0ch (Timer Power On days setting)  
 02: Repeat Daily  
 03: Repeat from Monday to Friday  
 04: Repeat from Monday to Saturday  
 05: Repeat from Saturday to Sunday  
 06: Repeat on Sunday  
 07: Repeat on Monday  
 08: Repeat on Tuesday  
 09: Repeat on Wednesday  
 0A: Repeat on Thursday  
 0B: Repeat on Friday  
 0C: Repeat on Saturday  
 Data2 00-17:00 - 23 hours  
 Data3 00-3B:00 - 59 minutes

\* To read or delete a Timer Power On you have set, [Data2] [Data3] must be set to FFH.

Example 1: fd 01 f1 ff ff - Reads the 1st index data in Timer Power On.

Example 2: fd 01 e1 ff ff - Reads the 1st index data in Timer Power On.

Example 3: fd 01 04 02 03 - Sets the Timer Power On as Monday - Saturday 02:03.

\* This feature only works when Clock 1 (year/month/day) and Clock 2 (hour/minute/second) have been set.

#### Acknowledgment

(d)( )(Set ID)( )(OK/NG)(Data1)(Data2)(Data3)(x)

## 87. [Time to OFF] Scheduling (Command: f e)

Sets Off Timer settings.

#### Transmission

(f)(e)( )(Set ID)( )(Data1)( )(Data2)( )(Data3)(Cr)

Data1

1. f1h to f7h (data reading)

F1: Reads the 1st Timer Power Off's data

F2: Reads the 2nd Timer Power Off's data

F3: Reads the 3rd Timer Power Off's data

F4: Reads the 4th Timer Power Off's data

F5: Reads the 5th Timer Power Off's data

F6: Reads the 6th Timer Power Off's data

F7: Reads the 7th Timer Power Off's data

2. e1h to e7h (Deletes one index), e0h (Deletes all indexes)

E0: Delete all Timer Power Off's

E1: Delete the 1st Timer Power Off

E2: Delete the 2nd Timer Power Off

E3: Delete the 3rd Timer Power Off

E4: Delete the 4th Timer Power Off

E5: Delete the 5th Timer Power Off

E6: Delete the 6th Timer Power Off

E7: Delete the 7th Timer Power Off

3. 01h to 0ch (Timer Power Off days setting)

02: Repeat Daily

03: Repeat from Monday to Friday

04: Repeat from Monday to Saturday

05: Repeat from Saturday to Sunday

06: Repeat on Sunday

07: Repeat on Monday

08: Repeat on Tuesday

09: Repeat on Wednesday

0A: Repeat on Thursday

0B: Repeat on Friday

0C: Repeat on Saturday

Data2 00-17:00 - 23 hours

Data3 00-3B:00 - 59 minutes

\* To read or delete a Timer Power Off you have set, [Data2] [Data3] must be set to FFH.

Example 1: fe 01 f1 ff ff - Reads the 1st index data in Timer Power Off.

Example 2: fe 01 e1 ff ff - Reads the 1st index data in Timer Power Off.

Example 3: fe 01 04 02 03 - Sets the Timer Power Off as Monday - Saturday 02:03.

\* This feature only works when Clock 1 (year/month/day) and Clock 2 (hour/minute/second) have been set.

#### Acknowledgment

(e)( )(Set ID)( )(OK/NG)(Data1)(Data2)(Data3)(x)

**88. LCIN008 Control (Command: s n, b8)**

It controls the LCIN008 device.

**Transmission**

(s)(n)( )(Set ID)( )(b)(8)( )(Data1)(Data2)(Cr)

Data 1 00: LCIN008 Power

01: LCIN008 Brightness

Data 2

1. For Power

0 x 00: Off

0 x 01: On

2. For Brightness

0 x ff: Read

0 x 00 ~ 0 x 64: Applies a set value

**Acknowledgement**

(n)( )(Set ID)( )(OK/NG)(b)(8)(Data1)(Data2)(x)

\* This feature may not be available for all models.

\* Other commands do not work for a certain time after applying.

**89. [Transfer Control] (Command: s n, cb)**

It transfers the command to RS232C out.

**Transmission**

(s)(n)( )(Set ID)( )(c)(b)( )(Data)(Cr)

Data Data that goes out to RS232C out

**Acknowledgment**

(n)( )(Set ID)( )(OK/NG)(c)(b)(Data)(x)

Data Response value of Data transferred to RS232C out

\* This feature may not be available for all models.

\* Other commands do not work for a certain time after applying.

**90. Multichannel (Command: s n, 76)**

It changes the channel.

**Transmission**

(s)(n)( )(Set ID)( )(7)(6)( )(Data)(Cr)

Data 01 - 09: Channel to switch to

**Acknowledgment**

(n)( )(Set ID)( )(OK/NG)(7)(6)(Data)(x)

\* This feature may not be available for all models.

**91. Change Setid (Command: j x)**

Changes and checks Setid.

1. When it is a general LED model

**Transmission**

(j)(x)( )(Set ID)( )(Data1)( )(Data2)(Cr)

Data1 Data2 : 00 01 ~ 03 e8 (1-1000)

**Acknowledgment**

(x)( )(Set ID)( )(OK/NG)(Data1)(Data2)(x)

2. When it is another model (read only)

**Transmission**

(j)(x)( )(Set ID)( )(Data)(Cr)

Data FF: Check the value of Setid

The returned value is indicated as a value of hexadecimal numbers corresponding to the ASCII code value.

(Return when Setid is 1: x 01 OK31x

Return when Setid is 1000: x 3e8 OK31303030x)

**Acknowledgment**

(x)( )(Set ID)( )(OK/NG)(Data)(x)

\* It works even if the Setid does not match.

**92. [Gamma] (Command: s n, ad)**

Sets Gamma Mode.

**Transmission**

(s)(n)( )(Set ID)( )(a)(d)( )(Data)(Cr)

Data 00: [low](1.9)

01: [medium](2.2)

02: [High1](2.4)

03: [High2](BT.1886)

**Acknowledgment**

(n)( )(Set ID)( )(OK/NG)(a)(d)(Data)(x)

\* This feature may not be available for all models.

**93. [Black Level] (Command: s n, ae)**

It sets the Black Level mode.

**Transmission**

(s)(n)( )(Set ID)( )(a)(e)( )(Data)(Cr)

Data 00: Low

01: High

02: Auto

**Acknowledgment**

(n)( )(Set ID)( )(OK/NG)(a)(e)(Data)(x)

\* This feature may not be available for all models.

**94. [UHD Deep Color] (Command: s n, af)**

It sets the UHD Deep Color mode for each input.

**Transmission**

(s)(n)( )(Set ID)( )(a)(f)( )(Data1)( )(Data2)(Cr)

Data1 70: DVI-D  
 90: HDMI1  
 91: HDMI2  
 92: OPS/HDMI3/DVI-D  
 95: OPS/DVI-D  
 96: HDMI3/DVI-D  
 97: HDMI3/HDMI2/DVI-D  
 98: OPS  
 99: HDMI2/OPS  
 C0: DISPLAYPORT  
 C1: DISPLAYPORT/USB-C  
 C2: HDMI3  
 C3: HDBaseT

Data2 00: [Off]  
 01: [On]

**Acknowledgment**

(n)( )(Set ID)( )(OK/NG)(a)(f)(Data1)(Data2)(x)

\* This feature may not be available for all models.

**95. [Sync Mode] (Command: s n, b0)**

Sets Sync Mode.

**Transmission**

(s)(n)( )(Set ID)( )(b)(0)( )(Data)(Cr)

Data 00: [Slave Mode]  
 01: [Master Mode]

**Acknowledgment**

(n)( )(Set ID)( )(OK/NG)(b)(0)(Data)(x)

\* This feature may not be available for all models.

**96. [Input Manager] (Command: s n, b1)**

It sets labels by input.

**Transmission**

(s)(n)( )(Set ID)( )(b)(1)( )(Data1)( )(Data2)(Cr)

Data1 90: HDMI1  
 91: HDMI2  
 92: OPS/HDMI3/DVI-D  
 95: OPS/DVI-D  
 96: HDMI3/DVI-D  
 97: HDMI3/HDMI2/DVI-D  
 98: OPS  
 99: HDMI2/OPS  
 C0: DISPLAYPORT  
 C1: DISPLAYPORT/USB-C  
 C2: HDMI3  
 C3: HDBaseT

Data2 00: DTV  
 01: PC

**Acknowledgment**

(n)( )(Set ID)( )(OK/NG)(b)(1)(Data1)(Data2)(x)

\* This feature may not be available for all models.

**97. [PC/OPS Power Control] (Command: s n, 8b)**

It sets the OPS/PC Power Control mode.

**Transmission**

(s)(n)( )(Set ID)( )(8)(b)( )(Data)(Cr)

Data 00: [Disable]  
 01: [Sync(On)]  
 02: [Sync(On/Off)]

**Acknowledgment**

(n)( )(Set ID)( )(OK/NG)(8)(b)(Data)(x)

\* This feature may not be available for all models.

**98. [LED Local Dimming] (Command: s n, c1)**

It sets [LED Local Dimming].

(A feature to set the LED Local Dimming in a sub-item under [Settings] → [Display] → [Expert Controls])

**Transmission**

(s)(n)( )(Set ID)( )(c)(1)( )(Data)(Cr)

Data 00: [Off]  
 01: [On]

**Acknowledgment**

(n)( )(Set ID)( )(OK/NG)(c)(1)(Data)(x)

\* This feature may not be available for all models.

**99. [Scan Inversion] (Command: s n, 87)**

It controls the on/off status of Scan Inversion.

**Transmission**

(s)(n)( ) (Set ID)( )(8)(7)( )(Data)(Cr)

Data 00: Off  
01: On

**Acknowledgment**

(n)( ) (Set ID)( )(OK/NG)(8)(7)(Data)(x)

\* This feature may not be available for all models.

\* If you change the values on a Video Wall model, please reboot for it to work normally.

**100. [Frame Control] (Command: s n, b7)**

It controls the Frame Control.

**Transmission**

(s)(n)( ) (Set ID)( )(b)(7)( )(Data)(Cr)

Data 00: Off  
01: On

**Acknowledgment**

(n)( ) (Set ID)( )(OK/NG)(b)(7)(Data)(x)

\* This feature may not be available for all models.

\* If you change the values on a Video Wall model, please reboot for it to work normally.

**101. [Average Picture Level Auto Control] (Command: s n, be)**

Sets Average Picture Level Auto Control.

**Transmission**

(s)(n)( ) (Set ID)( )(b)(e)( )(Data)(Cr)

Data 00: [Off]  
01: [On]

**Acknowledgment**

(n)( ) (Set ID)( )(OK/NG)(b)(e)(Data)(x)

\* This feature may not be available for all models.

**102. Read Brightness Value (Command: m u)**

Checks the brightness value.

**Transmission**

(m)(u)( ) (Set ID)( )(FF)(Cr)

**Acknowledgment**

(u)( ) (Set ID)( )(OK/NG)(Data1)(Data2)(Data3)(Data4)(Data5)(Data6)(Data7)(x)

Data 1 00-64: Backlight PWM figure 0-100

Data 2 00-ff: The upper 1-byte of the value measured by the CA210.

Data 3 00-ff: The lower 1-byte of the value measured by the CA210.

The CA210 measurement is Hex: 0000-ffff, Decimal: 0 - 65535

Data 4 00-ff: The upper 1-byte of the value measured by BLU 1 Sensor.

Data 5 00-ff: The lower 1-byte of the value measured by BLU 1 Sensor

Data 6 00-ff: The upper 1-byte of the value measured by BLU 2 Sensor

Data 7 00-ff: The lower 1-byte of the value measured by BLU 2 Sensor

The BLU measurement is Hex: 0000-ffff, Decimal: 0 - 65535

\* The CA210 measurement is entered as "Calibration" when the product is released from the factory. It is Default 0 before the calibration.

\* This feature may not be available for all models.

**103. [Screen Fault Detection] (Command: t z)**

Sets the Screen Fault Detection feature.

**Transmission**

(t)(z)( ) (Set ID)( )(Data)(Cr)

Data 00: [Off]  
01: [On]

**Acknowledgment**

(z)( ) (Set ID)( )(OK/NG)(Data)(x)

\* This feature may not be available for all models.

**104. [Stereo Mode] (Command: s n, c2)**

Controls Stereo Mode.

**Transmission**

(s)(n)( ) (Set ID)( )(c)(2)( )(Data)(Cr)

Data 00: Left/Right  
01: Left/Left  
02: Right/Right

**Acknowledgment**

(n)( ) (Set ID)( )(OK/NG)(c)(2)(Data)(x)

\* This feature may not be available for all models.

**105. [HDR Picture Mode] (Command: s n, c4)**

Selects a HDR Picture Mode.

**Transmission**`(s)(n)( ) (Set ID)( ) (c)(4)( ) (Data)(Cr)`

Data 00: Mall/QSR  
 01: General  
 02: Gov./Corp.  
 04: Education

**Acknowledgment**`(n)( ) (Set ID)( ) (OK/NG)(c)(4)(Data)(x)`

\* Depending on the model, some picture modes may not be supported.

\* It works only when the HDR content is running.

**106. [Dynamic Tone Mapping] (Command: s n, c5)**

Selects Dynamic Tone Mapping.

**Transmission**`(s)(n)( ) (Set ID)( ) (c)(5)( ) (Data)(Cr)`

Data 00: [Off]  
 01: [On]

**Acknowledgment**`(n)( ) (Set ID)( ) (OK/NG)(c)(5)(Data)(x)`

\* Depending on the model, some picture modes may not be supported.

\* It works only when the HDR content is running.

**107. [LED Local Dimming] (Command: s n, c6)**

Sets the LED Local Dimming.

(A feature to set the LED Local Dimming in a sub-item under [Settings] → [Display] → [Picture Mode] → [Picture Options])

**Transmission**`(s)(n)( ) (Set ID)( ) (c)(6)( ) (Data)(Cr)`

Data 00: [Off]  
 01: [low]  
 02: [Medium]  
 03: [High]

**Acknowledgment**`(n)( ) (Set ID)( ) (OK/NG)(c)(6)(Data)(x)`

\* This feature may not be available for all models.

**108. [USB2 to HDBaseT] (Command: s n, c3)**

Sets USB2 to HDBaseT.

**Transmission**`(s)(n)( ) (Set ID)( ) (c)(3)( ) (Data)(Cr)`

Data 00: [Off]  
 01: [On]

**Acknowledgment**`(n)( ) (Set ID)( ) (OK/NG)(c)(3)(Data)(x)`

\* This feature may not be available for all models.

**109. [Change Password] (Command: s n, a7)**

Changes password.

**Transmission**`(s)(n)( ) (Set ID)( ) (a)(7)( ) (Data1)(Data2)(Data3)`

`(Data4)(Data5)(Data6)( ) (Data7)(Data8)(Data9)`  
`(Data10)(Data11)(Data12)(Cr)`

Data 1-6 : 0-9(Previously set password)  
 Data 7-12 : 0-9(New password)

**Acknowledgment**`(n)( ) (Set ID)( ) (OK/NG)(a)(7)( ) (Data1)(Data2)(Data3)`

`(Data4)(Data5)(Data6)( ) (Data7)(Data8)(Data9)`  
`(Data10)(Data11)(Data12)(x)`

\* This feature may not be available for all models.

**110. [Brightness Range Adjustment] (Command: s n, ab)**

Adjust the brightness range.

**Transmission**`(s)(n)( ) (Set ID)( ) (a)(b)( ) (Data1)( ) (Data2)(Cr)`

Data 1 00: Minimum brightness control  
 01: Maximum brightness control

Data 1 00-64: Range control

**Acknowledgment**`(n)( ) (Set ID)( ) (OK/NG)(a)(b)(Data1)(Data2)(x)`

\* This feature may not be available for all models.

\* Data2 only supports Hex values that are multiples of 5.

\* The range of minimum brightness value cannot exceed the range of maximum brightness, and the range of maximum brightness value cannot be less than the range of minimum brightness.

**111. [Color Calibration] (Command: s n, d6)**

Selects Color Calibration.

**Transmission**`(s)(n)( )(Set ID)( )(d)(6)( )(Data)(Cr)`

Data 00: Off

01: On

**Acknowledgement**`(n)( )(Set ID)( )(OK/NG)(d)(6)(Data)(x)`

\* It may not be supported depending on the model.

**112. [Quiet Mode] (Command: s n, c7)**

Selects Quiet Mode.

**Transmission**`(s)(n)( )(Set ID)( )(c)(7)( )(Data)(Cr)`

Data 00: Off

01: On

**Acknowledgement**`(n)( )(Set ID)( )(OK/NG)(c)(7)(Data)(x)`

\* It may not be supported depending on the model.

